

# Poly-Phase Step-Down DC/DC Controller with Power System Management

## DESCRIPTION

Demonstration circuit 2454A is a high current, high efficiency, poly-phase synchronous buck converter featuring the **LTC®3887EUJ-1**, a dual-phase current mode controller, and the **LTC3870EUF-1**, a dual-phase slave controller. The LTC3887-1 has the PMBus interface and the power system management functions.

The DC2454A uses DrMOS in the power stage and inductor DCR sensing. The input voltage range of this board is from 7V to 14V, and the output voltage can be programmed from 0.8V to 1.8V. The output current is up to 100A with 4-phase operation. The factory default setting for the output is 1.0V. This demo board also has an on-board dynamic load circuit, which makes it easy to evaluate the transient performances.

The DC2454A powers up to default settings and produces power based on configuration resistors or NVM without the need for any serial bus communication. This allows easy evaluation of the DC/DC converter aspects of the

LTC3887-1. To fully explore the extensive power system management features, download the GUI software LTpowerPlay® onto your PC and use LTC's I<sup>2</sup>C/SMBus/PMBus Dongle DC1613A to connect to the board. LTpowerPlay allows the user to reconfigure the part on the fly and store the configuration in EEPROM, view telemetry of voltage, current, temperature and fault status.

### GUI LTpowerPlay Download

The software can be downloaded from:

<http://www.linear.com/ltpowerplay>

For more details and instructions of LTpowerPlay, please refer to "LTpowerPlay for LTC3880 Quick Start Guide".

**Design files for this circuit board are available at**  
<http://www.linear.com/demo/DC2454A>

LT, LT, LTC, LTM, Linear Technology, LTpowerPlay and the Linear logo are registered trademarks of Linear Technology Corporation. All other trademarks are the property of their respective owners.

## PERFORMANCE SUMMARY Specifications are at T<sub>A</sub> = 25°C

SYMBOL	PARAMETER	CONDITIONS	MIN	TYP	MAX	UNITS
V <sub>IN</sub>	Input Supply Range		7	12	14	V
V <sub>OUT0</sub>	Output Voltage Range	I <sub>OUT</sub> = 0A TO 100A, V <sub>IN</sub> = 7.0V to 14V	0.8	1.0	1.8	V
I <sub>OUT0</sub>	Output Current Range		0		100	A
f <sub>SW</sub>	Factory Default Switching			425		kHz
EFF	Full Load Efficiency	V <sub>OUT</sub> = 1.0V, See Figures 4.		89.1		%

## QUICK START PROCEDURE

Demonstration circuit 2454A makes it easy to set up to evaluate the performances of the LTC3887-1 and the slave controller LTC3870-1. Refer to Figure 2 for proper measurement equipment setup and follow the procedure below:

1. Make sure jumpers are in the following positions:

JUMPER	POSITION	FUNCTION
JP1	C	GPIO0B to GPIO1B
JP3	EXT	External/Internal pulse for load transient circuit
JP4	ON	VDR for DrMOS
JP5	OFF	Power supply for pulse generator
SW1	OFF	RUN pin

2. With power off, connect the input power supply to  $V_{IN}$  and GND. Connect active load to the output.
3. Make sure RUN switch (SW1) is OFF.
4. Turn on the power at the input.

NOTE: Make sure that the input voltage does not exceed 16V.

5. Turn on RUN switch (SW1).
6. Check for the correct output voltage from E6 and E7.

$$V_{OUT} = 1.0V \pm 0.5\% (1.005V \sim 0.995V)$$

NOTE: If there is no output, temporarily disconnect the load to make sure that the load is not set too high.

7. Once the proper output voltage is established, adjust the loads within the operating range and observe the output voltage regulation, ripple voltage, efficiency and other parameters.
8. Connect the dongle and control the output voltage from the GUI. See LTpowerPlay Quick Start Procedure section for details.

### Connecting a PC to DC2454A

You can use a PC to reconfigure the power management features of the LTC3887-1 such as: nominal  $V_{OUT}$ , margin set points, OV/UV limits, temperature fault limits, sequencing parameters, the fault log, fault responses, GPIO and other functionality. The DC1613A dongle may be plugged in regardless of whether or not  $V_{IN}$  is present. Dongle can be hot plugged.

NOTE: For better thermal dissipation, it is suggested to pull load current symmetrically, as shown in Figure 2.

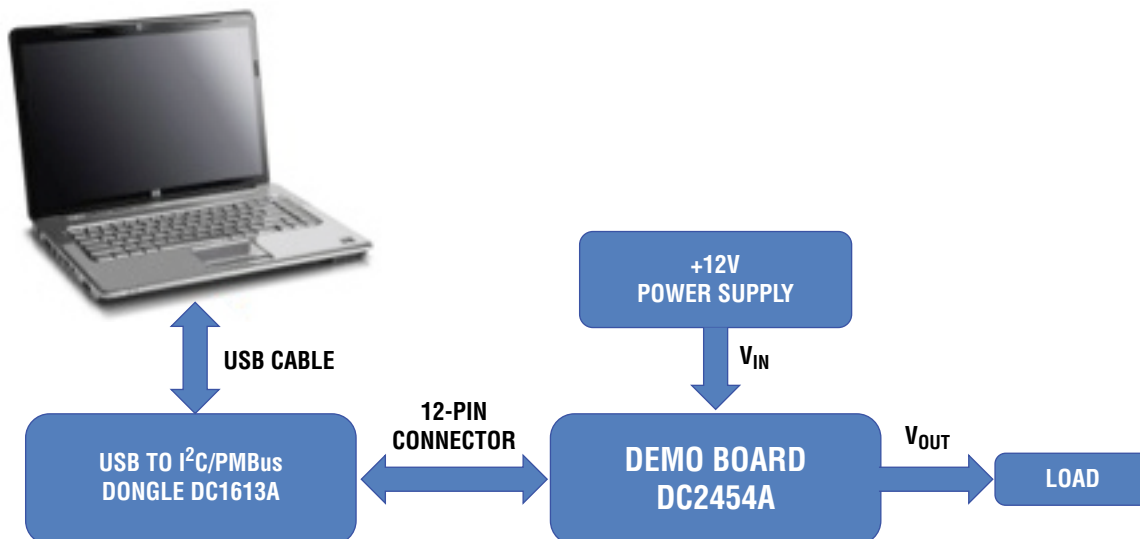

Figure 1. Demo Setup with PC

## QUICK START PROCEDURE

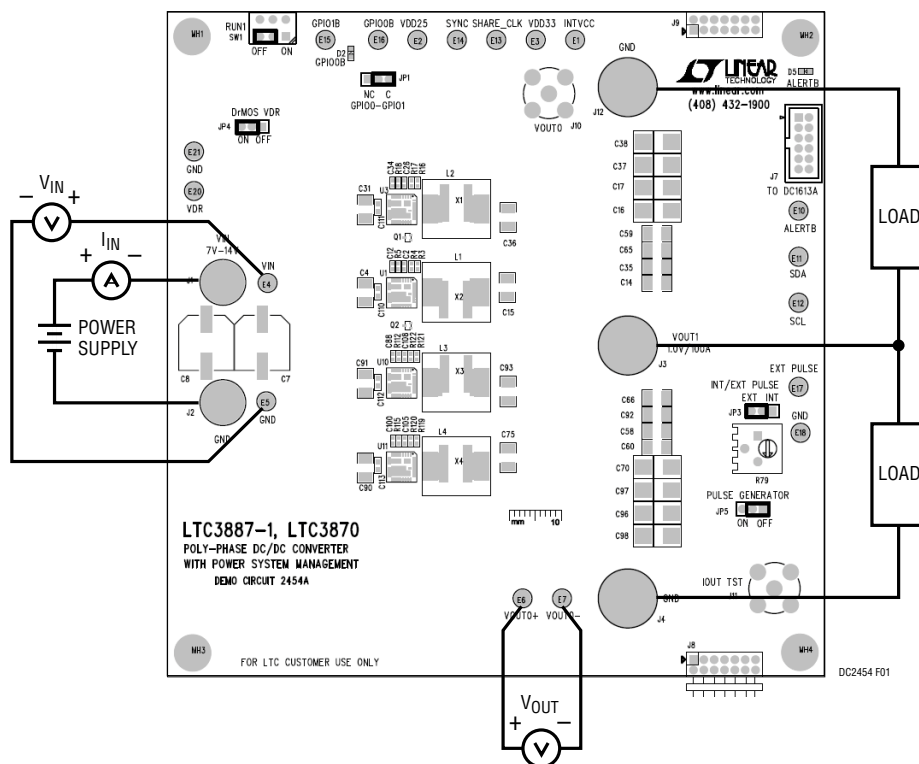

Figure 2. Power Test Setup

### Measuring Efficiency

To accurately measure efficiency of any configuration, do the following:

- Set JP4 to OFF position to disable the auxiliary circuits; use external 5V supply for VDR and include it in the efficiency calculation.
- Measure  $V_{IN}$  across the input ceramic capacitor (C4). Measure  $V_{OUT}$  across the output ceramic capacitor (C15).

### Measuring Output Ripple Voltage

An accurate ripple measurement may be performed by using the below configuration across C15.

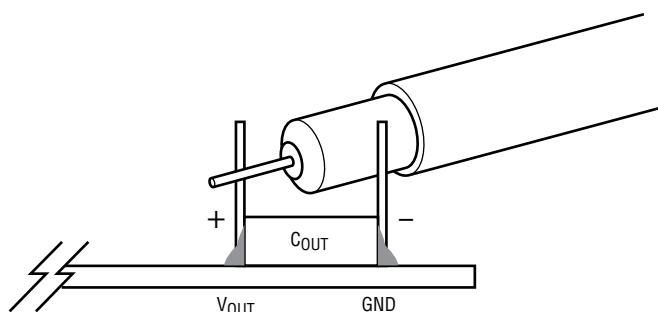

Figure 3. Measuring Output Voltage Ripple

NOTE: When measuring the input or output voltage ripple, care must be taken to avoid a long ground lead on the oscilloscope probe. Measure the output voltage ripple by touching the probe tip directly across the C15.

## QUICK START PROCEDURE

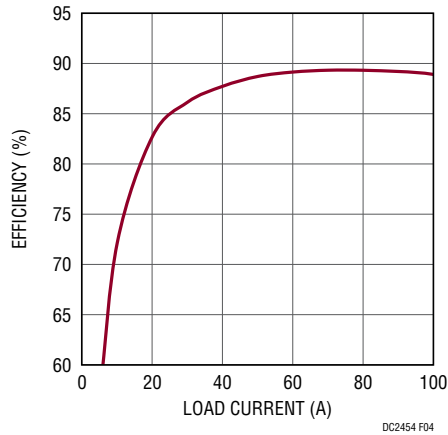

Figure 4. Typical Efficiency Curve of DC2454A,  $f_{SW} = 425\text{kHz}$

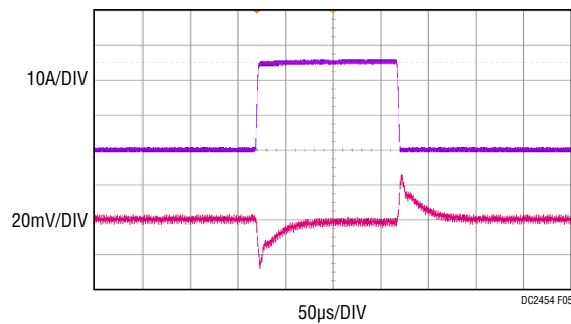
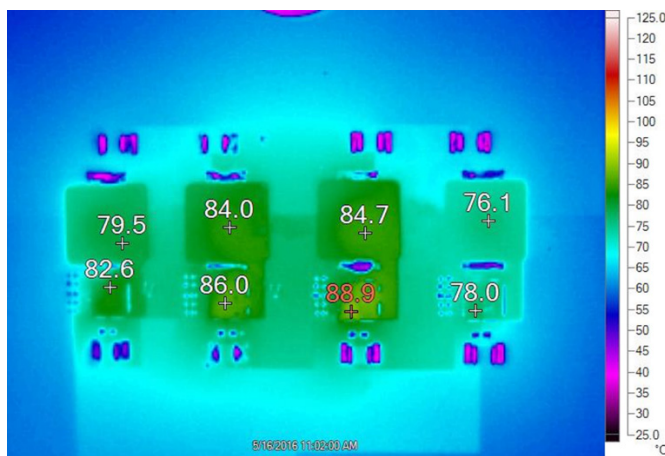
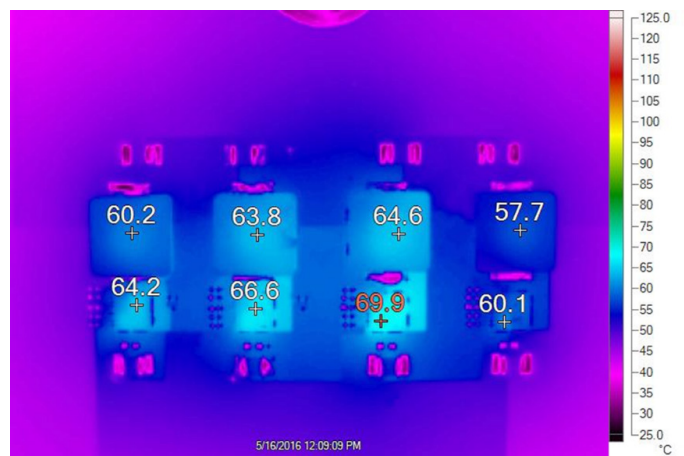

Figure 5. Load Transient Waveform of DC2454A,  $f_{SW} = 425\text{kHz}$ , 0A to 25A Load Step



a) No Airflow



b) 200LFM Airflow

Figure 6. Thermal Pictures of DC2454A,  $V_{IN} = 12\text{V}$ ,  $V_O = 1.0\text{V}$ ,  $f_{SW} = 425\text{kHz}$ ,  $T_A = 25^\circ\text{C}$

## LTpowerPlay SOFTWARE GUI

LTpowerPlay is a powerful Windows based development environment that supports Linear Technology® power system management ICs, including the LTC3880, LTC3883, LTC2974 and LTC2978. The software supports a variety of different tasks. You can use LTpowerPlay to evaluate Linear Technology ICs by connecting to a demo board system. LTpowerPlay can also be used in an offline mode (with no hardware present) in order to build a multichip configuration file that can be saved and reloaded at a later time. LTpowerPlay provides unprecedented diagnostic and debug features. It becomes a valuable diagnostic tool during board bring-up to program or tweak the power management scheme in a system, or to diagnose power

issues when bringing up rails. LTpowerPlay utilizes the DC1613A USB-to-SMBus controller to communicate with one of many potential targets, including the LTC3887-1's DC2454A demo system, or a customer board. The software also provides an automatic update feature to keep the software current with the latest set of device drivers and documentation. The LTpowerPlay software can be downloaded from:

<http://linear.com/ltpowerplay>

To access technical support documents for LTC Digital Power Products visit Help. View online help on the LTpowerPlay menu.

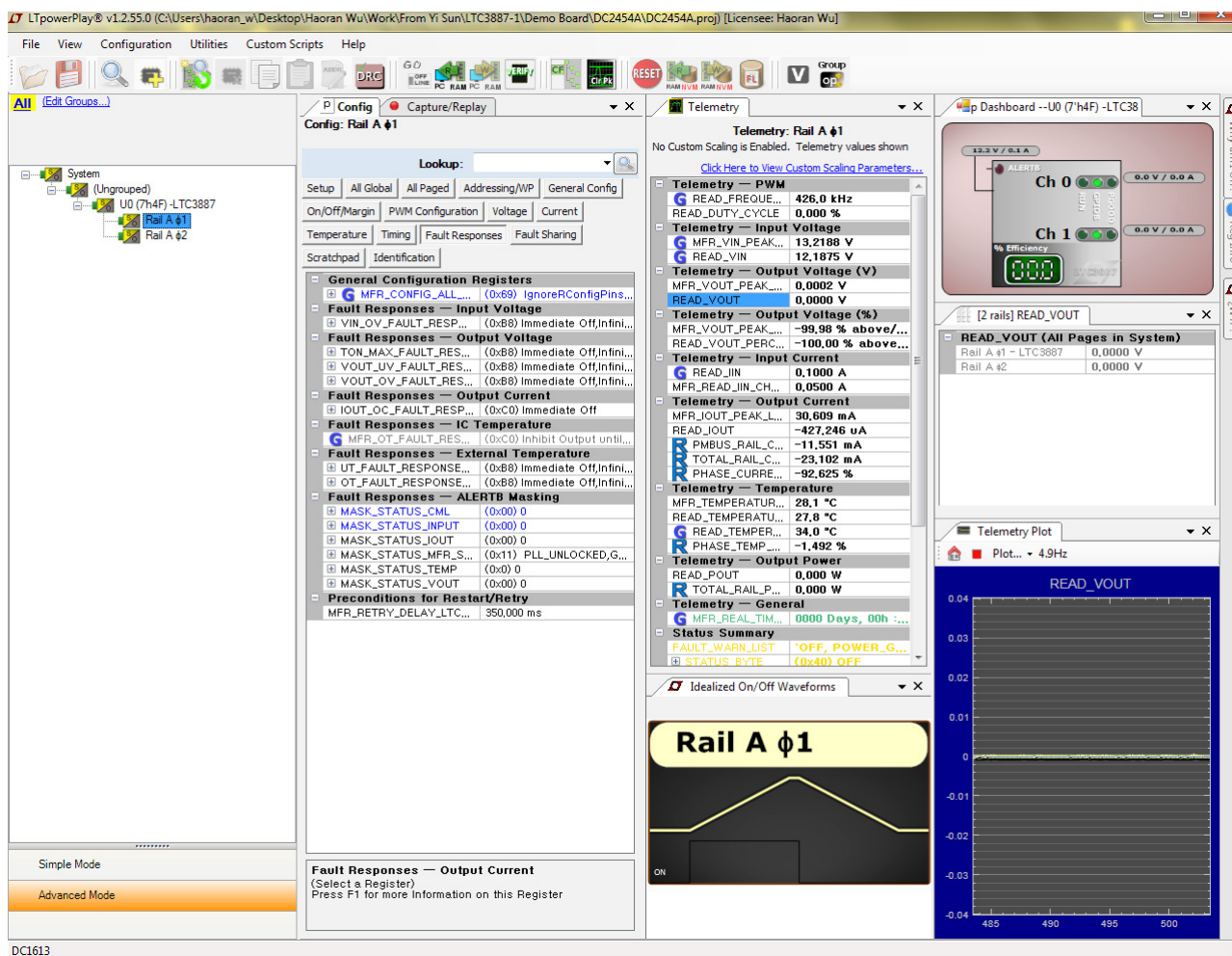

Figure 7. LTpowerPlay Main Interface

## LTpowerPlay QUICK START PROCEDURE

The following procedure describes how to use LTpowerPlay to monitor and change the settings of LTC3887-1.

1. Download and install the LTpowerPlay GUI:

<http://linear.com/ltpowerplay>

2. Launch the LTpowerPlay GUI.

- a. The GUI should automatically identify the DC2454A. The system tree on the left hand side should look like this:

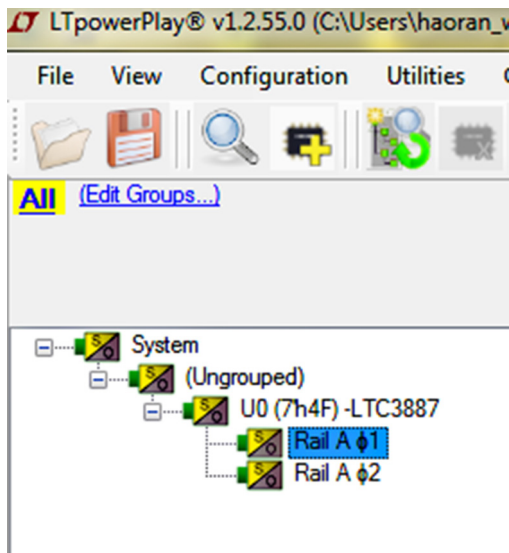

- b. A green message box shows for a few seconds in the lower left hand corner, confirming that the LTC3887-1 is communicating:

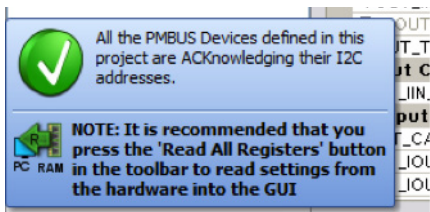

- c. In the Toolbar, click the “R” (RAM to PC) icon. This reads the configuration from the RAM of LTC3887-1 and loads it into the GUI.



- d. If you want to change the output voltage to a different value, like 1.5V. In the Config tab, type in 1.5 in the VOUT\_COMMAND box, like this:

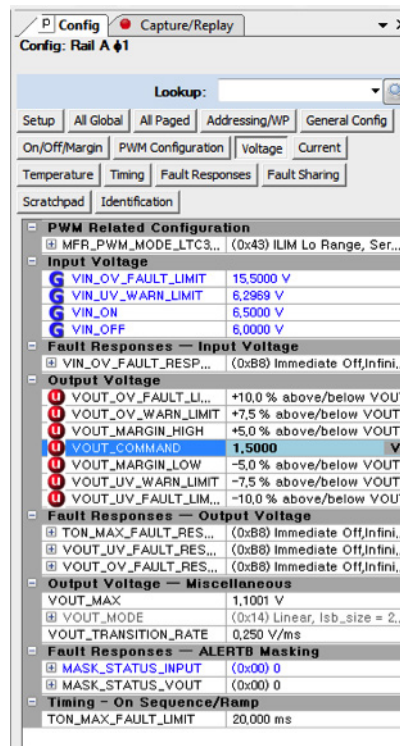

Then, click the “W” (PC to RAM) icon to write these register values to the LTC3887-1. After finishing this step, you will see the output voltage will change to 1.5V.



If the write is successful, you will see the following message:



## LTpowerPlay QUICK START PROCEDURE

e. You can save the changes into the NVM. In the tool bar, click “RAM to NVM” button, as following



g. Since there are two slave phases on this board, to achieve the correct total rail current reading, some parameters should be set in LTpowerPlay, as shown in the screen shot below.

f. Save the demo board configuration to a (\*.proj) file. Click the Save icon and save the file. Name it whatever you want.

1. CLICK HERE → **Setup**

2. CHECK HERE →  This Rail Has Additional non-PmBus phases

3. TYPE "2" HERE → **Y: 2**

**VOUT\* Scale Factor**: 1.0000000  
**VOUT\* Offset (V)**: 0.0000000  
**IOUT\* Scale Factor**: 1.0000000  
**IOUT\* Offset (A)**: 0.0000000

**Total Rail Output Current Calculation**  
 This Rail Has Additional non-PmBus phases

**PMBUS\_RAIL\_CURRENT** =  $\sum_{j=1}^X I_j$  (measured via PmBus READ\_)

**TOTAL\_RAIL\_CURRENT** = Calculated  $\sum$  of All Phase Curr (includes non-PMbus Slave PI)  
 =  $(1 + K/X * Y) * PMBUS\_RAIL\_CURRENT$   
 =  $2.000 * PMBUS\_RAIL\_CURRENT$

[Show me How to Configure These Parameters...](#)

**X**: 2 (The total number of phases with the same r (PSM IC))  
**Y**: 2 (The total number of phases without rail addr (non-PSM IC))  
**K**: 1.00 (Scaling Factor = slave phase current / mast phase current (Assuming all phases share c w/ same ratio))  
 $I_j$ : PmBus READ IOUT channel current readback (Only for channels with PMBUS address)

# DEMO MANUAL DC2454A

## PARTS LIST

ITEM	QTY	REFERENCE	PART DESCRIPTION	MANUFACTURER/PART NUMBER
<b>Required Circuit Components</b>				
1	8	C1, C2, C25, C26, C103, C105, C107, C108	CAP, 1 $\mu$ F, X5R, 16V, 10%, 0402	MURATA, GRM155R61C105KE01D
2	8	C3, C27, C102, C104, C12, C34, C88, C100	CAP, 0.1 $\mu$ F, X5R, 16V, 10%, 0402	MURATA, GRM155R61C104KA88D
3	8	C4, C6, C31, C33, C86, C87, C90, C91	CAP, 22 $\mu$ F, X5R, 16V, 10%, 1210	MURATA, GRM32DR61C226KE18L
4	7	C5, C13, C39, C49, C51, C106, C109	CAP, 1 $\mu$ F, X5R, 16V, 10%, 0603	MURATA, GRM188R61C105KA93D
5	2	C7, C8	CAP, OS-CON, 330 $\mu$ F, 16V, 20% F12	PANASONIC ELECTRONIC, 16SVP330M
6	5	C10, C11, C56, C80, C83	CAP, 4.7 $\mu$ F, X5R, 16V, 10%, 0603	MURATA, GRM188R61C475KAAJD
7	24	C14, C15, C21, C22, C35, C36, C42, C43, C58, C59, C60, C61, C64, C65, C66, C67, C75, C76, C84, C85, C92, C93, C94, C95	CAP, X5R, 100 $\mu$ F, 6.3V, 20%, 1210	MURATA, GRM32ER60J107ME20L
8	8	C16, C17, C37, C38, C70, C96, C97, C98	CAP, POSCAP, 470 $\mu$ F, 2.5V, D2E SIZE	PANASONIC ELECTRONIC, 2R5TPE470M9
9	1	C24	CAP, X7R, 4700pF, 25V, 10%, 0603	MURATA, GRM188R71E472KA01D
10	1	C50	CAP, NPO, 150pF, 50V, 5%, 0603	MURATA, GRM1885C1H151JA01D
11	3	C28, C29, C77	CAP, NPO, 270pF, 50V, 5%, 0603	MURATA, GRM1885C1H271JA01D
12	4	L1, L2, L3, L4	IND., 0.15 $\mu$ H	WURTH ELEKTRONIK, 744355215
13	1	R15	RES., 3.65k, 1/10W, 1%, 0603	VISHAY, CRCW06033K65FKEA
14	10	R19, R20, R27, R29, R32, R35, R38, R51, R60, R61	RES., 4.99k, 1/10W, 1%, 0603	VISHAY, CRCW06034K99FKEA
15	1	R83	RES., 15.8k, 1/10W, 1%, 0603	VISHAY, CRCW060315K8FKEA
16	1	R123	RES., 90.9k, 1/10W, 1%, 0603	VISHAY, CRCW060390K9FKEA
17	4	U1, U3, U10, U11	I.C., MODULE, 60A, 31-LEAD, CLIP BOND PQFN, SPS, 5.0X5.0mm	FAIRCHILD SEMI., FDMF5820DC
18	1	U2	I.C., LTC3887-1EUJ, QFN, 6X6mm	LINEAR TECH., LTC3887EUJ-1#10EU-1PBF-ES
19	1	U4	I.C., EEPROM 2kBIT 400kHz 8TSSOP	MICROCHIP, 24LC025-I/ST
20	1	U5	I.C., LTC6992CS6-1, TSOT-23	LINEAR TECH., LTC6992CS6-1#PBF
21	1	U6	I.C., LT1803IS5, TSOT-23	LINEAR TECH., LT1803IS5#PBF
22	2	U7, U8	I.C., LT1129CS8-5, S8	LINEAR TECH., LT1129CS8-5#PBF
23	1	U12	I.C., LTC3870-1EUFD QFN 4x4mm	LINEAR TECH., LTC3870EUFD-1#PBF

## PARTS LIST

ITEM	QTY	REFERENCE	PART DESCRIPTION	MANUFACTURER/PART NUMBER
<b>Additional Demo Board Circuit Components</b>				
1	7	C9, C74, C18, C44, C89, C101, C47	CAP, 0.1 $\mu$ F, X7R, 16V, 10%, 0603	MURATA, GRM188R71C104KA01D
2	0	C19, C20, C40, C41, C71, C72, C73, C99	CAP, OPTIONAL D2E	
3	3	C30, C32, C45	CAP, X7R, 0.01 $\mu$ F, 16V, 10%, 0603	MURATA, GRM188R71C103KA01D
4	1	C48	CAP, X5R, 2.2 $\mu$ F, 16V, 10%, 0805	MURATA, GRM21BR61C225KA88L
5	1	C52	CAP, 4.7 $\mu$ F, X5R, 16V, 1206	MURATA, GRM31CR61C475KA01L
6	1	C53	CAP, 1 $\mu$ F, X7R, 16V, 10%, 0805	MURATA, GRM21BR71C105KA01L
7	2	C54, C57	CAP, 1 $\mu$ F, X5R, 16V, 10%, 1206	MURATA, GRM31MR61C105KA01L
8	2	D2, D5	SMT CHIP LED, GREEN	WURTH ELEKTRONIK, 150060GS75000
9	0	D3, D4	IND., OPTIONAL SOD-323	
10	2	Q1, Q2	TRANS., PNP 40V 0.2A SC75-3 SOT-416	ON SEMI., MMBT3906TT1G
11	1	Q4	MOSFET, N-CH 60V 115MA SOT23-3	DIODES INC., 2N7002-7-F
12	2	Q5, Q7	MOSFET, P-CH 20V 0.58A SOT-23	VISHAY, SI2365EDS-T1-GE3
13	1	Q6	MOSFET, SPEED SRS 30V 30A LPAK	RENESAS, RJK0305DPB-02#J0
14	4	R1, R12, R117, R118	RES., 24.9k, 1/16W, 1%, 0402	VISHAY, CRCW040224K9FKED
15	3	R2, R67, R93	RES., 2 $\Omega$ , 1/10W, 1%, 0603	VISHAY, CRCW06032R00FKEA
16	4	R3, R16, R119, R121	RES., 1k, 1/16W, 1%, 0402	VISHAY, CRCW04021K0FKED
17	0	R4, R17, R120, R122	RES., OPTIONAL 0402	
18	4	R5, R18, R112, R115	RES., 0 $\Omega$ , 1/16W, 0402	VISHAY, CRCW04020000Z0ED
19	8	R7, R8, R24, R25, R110, R111, R113, R114	RES., 2k, 1/10W, 1%, 0603	VISHAY, CRCW06032K00FKEA
20	8	R10, R13, R49, R52, R55, R68, R125, R128	RES., 0 $\Omega$ , 1/10W, 0603	VISHAY, CRCW06030000Z0EA
21	0	R21, R22, R23, R28, R30, R31, R33, R34, R36, R37, R39, R40, R54, R56, R62, R64, R65, R124, R126, R127	RES., OPTIONAL 0603	
22	1	R47	RES., 200 $\Omega$ , 1/10W, 1%, 0603	VISHAY, CRCW0603200RFKEA
23	2	R58, R77	RES., 10 $\Omega$ , 1/10W, 1%, 0603	VISHAY, CRCW060310R0FKEA
24	1	R63	RES., 127 $\Omega$ , 1/10W, 1%, 0603	VISHAY, CRCW0603127RFKEA
25	2	R69, R76	RES., 20k, 1/10W, 1%, 0603	VISHAY, CRCW060320K0FKEA
26	2	R70, R81	RES., 100k, 1/10W, 1%, 0603	VISHAY, CRCW0603100KFKEA
27	1	R71	RES., 3.3 $\Omega$ , 1/10W, 1%, 0603	VISHAY, CRCW06033R30FKEA
28	1	R72	RES., CHIP 1M, 1%, 0603	VISHAY, CRCW06031M00FKEA
29	1	R73	RES., 154k, 1/10W, 1%, 0603	VISHAY, CRCW0603154KFKEA
30	2	R74, R82	RES., 10k, 1/10W, 1%, 0603	VISHAY, CRCW060310K0FKEA
31	1	R75	RES., 82.5 $\Omega$ , 1/10W, 1%, 0603	VISHAY, CRCW060382R5FKEA
32	1	R78	RES., 681k, 1/10W, 1%, 0603	VISHAY, CRCW0603681KFKEA
33	1	R79	TRIMMER, 5k 0.5W PC PIN	BOURNS, 3386P-1-502LF
34	1	R80	SENSE RES., 0.01 $\Omega$ 1% 1W 2512	PANASONIC,, ERJM1WSF10MU

# DEMO MANUAL DC2454A

## PARTS LIST

ITEM	QTY	REFERENCE	PART DESCRIPTION	MANUFACTURER/PART NUMBER
<b>Hardware: For Demo Board Only</b>				
1	21	E1-E7, E10-E21	TEST POINT, TURRET, .064" MTG. HOLE	MILL-MAX, 2308-2-00-80-00-00-07-0
2	4	JP1, JP3, JP4, JP5	CONN., HEADER, 1X3, 2mm	WURTH ELEKTRONIK, 62000311121
3	2	J1, J2	JACK, BANANA	KEYSTONE, 575-4
4	3	J3, J4, J12	STUD, TEST PIN	PEM, KFH-032-10
5	6	J3, J4, J12 (x2)	NUT, BRASS 10-32	ANY, 10-32M/S BR PL
6	3	J3, J4, J12	LUG RING, #10	KEYSTONE 8205
7	3	J3, J4, J12	WASHER, TIN PLATED BRASS	ANY, #10
8	1	J7	CONN. HEADER 12POS 2mm STR DL PCB	FCI, 98414-G06-12ULF
9	1	J8	CONN., HEADER, 2X7, 2mm, R/A (M)	MOLEX, 87760-1416
10	1	J9	CONN., HEADER, 2X7, 2mm, R/A (F)	SULLINS, NPPN072FJFN-RC
11	2	J10, J11	CONN., BNC, 5PINS	CONNEX, 112404
12	1	SW1	SWITCH, SLIDE DPDT 300MA 6V	C&K COMPONENTS, JS202011CQN
13	3	XJP1, XJP2, XJP5	SHUNT, 2mm	WURTH ELEKTRONIK, 60800213421
14	4	MT1, MT2, MT3, MT4	STANDOFF, NYLON, SNAP-ON, 0.625"	WURTH ELEKTRONIK, 702936000

## SCHEMATIC DIAGRAM

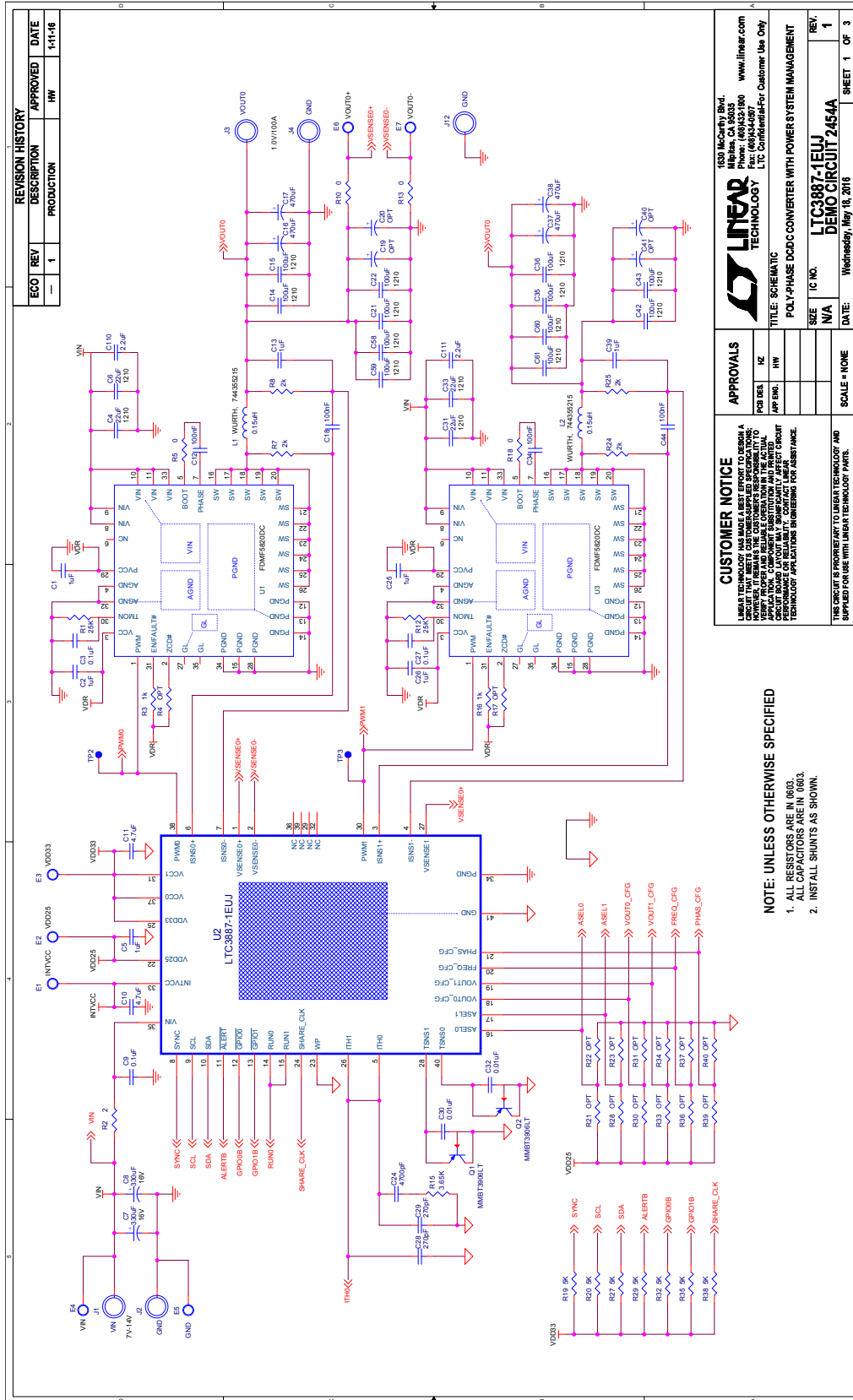

REVISION HISTORY			
ECO	REV	DESCRIPTION	DATE
—	1	PRODUCTION	11-18

APPROVALS	
FOR DES	RZ
FOR FEM	HW

CUSTOMER NOTICE	
LINEAR TECHNOLOGY HAS MADE A BEST EFFORT TO DESIGN A BOARD THAT WILL OPERATE WITH THE ACTUAL PARTS. HOWEVER, IT REMAINS THE CUSTOMER'S RESPONSIBILITY TO VERIFY BOARD AND PARTS OPERATION IN THE ACTUAL APPLICATION. LINEAR TECHNOLOGY ACCEPTS NO LIABILITY FOR ANY DAMAGE TO THE BOARD OR PARTS. CUSTOMER APPLICATIONS ENGINEERS FOR ASSISTANCE.	

TITLE SCHEMATIC	
POLY-PHASE DC/DC CONVERTER WITH POWER SYSTEM MANAGEMENT	
IC NO.	LTC3887-1EUJ
SIZE	N/A
DATE	Wednesday, May 18, 2016

**NOTE: UNLESS OTHERWISE SPECIFIED**

1. ALL RESISTORS ARE IN ΩΩΩ.
2. ALL CAPACITORS ARE IN PPF.

# DEMO MANUAL DC2454A

## SCHEMATIC DIAGRAM

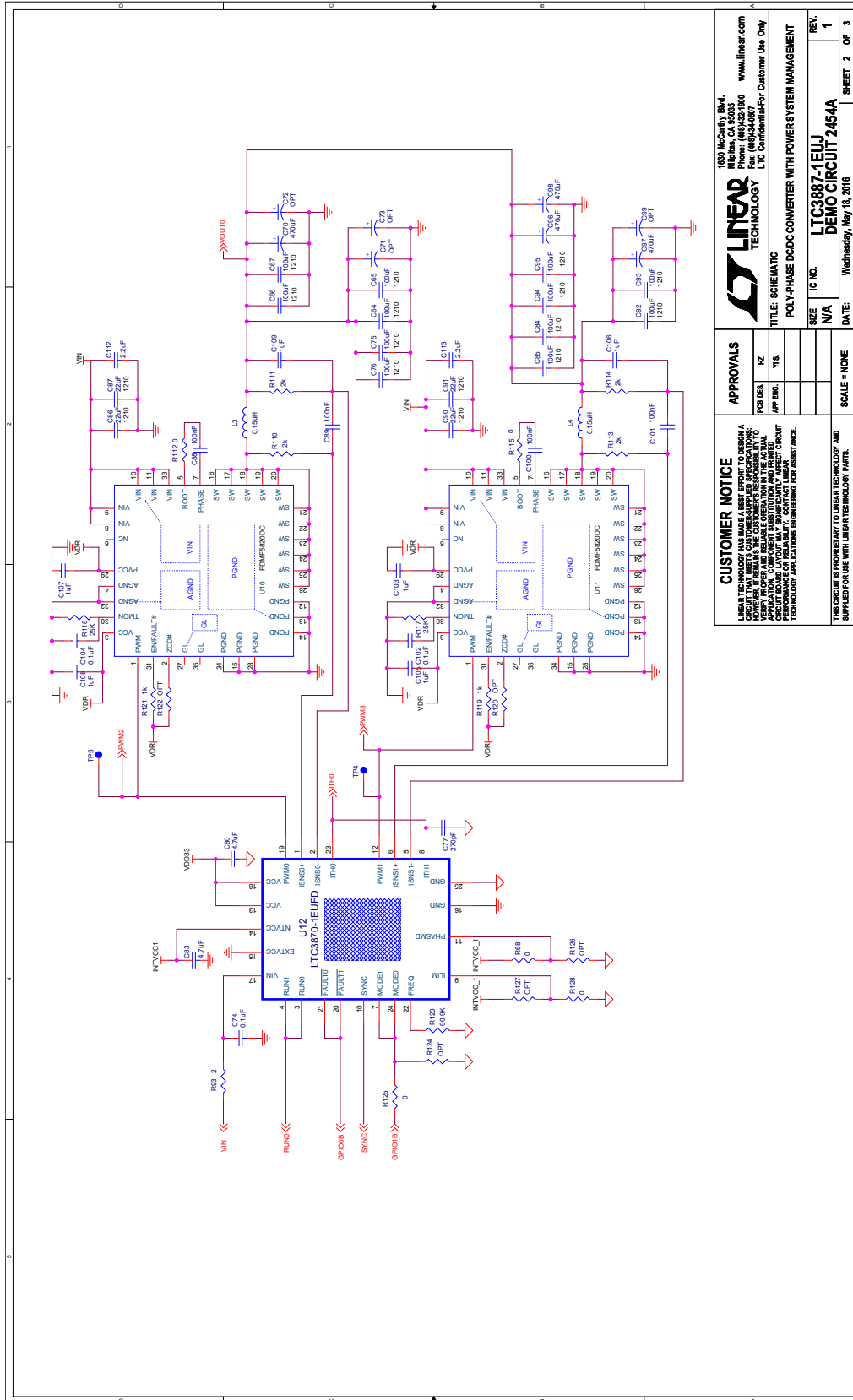

**1930 McCarty Blvd.**  
**Woburn, MA 01895**  
**Phone: (603)251-1900**  
**Fax: (603)251-4307**  
**LTC Confidential-For Customer Use Only**

**LINEAR TECHNOLOGY**

**www.linear.com**  
**Customer Use Only**

**TITLE SCHEMATIC**  
**POLY-PHASE DcDc CONVERTER WITH POWER SYSTEM MANAGEMENT**

**REV. 1**  
**IC NO. LTC3887-1EJLJ**  
**DEMO CIRCUIT 2454A**

**DATE: Wednesday, May 18, 2016**  
**SHEET 2 OF 3**

**CUSTOMER NOTICE**  
 LINEAR TECHNOLOGY HAS MADE A BEST EFFORT TO DESIGN A SCHEMATIC THAT WILL WORK WITH THE CUSTOMER'S COMPONENTS. HOWEVER, IT REMAINS THE CUSTOMER'S RESPONSIBILITY TO VERIFY PROPER AND RELIABLE OPERATION IN THE ACTUAL APPLICATION. LINEAR TECHNOLOGY WILL NOT BE RESPONSIBLE FOR ANY CIRCUIT BOARD FAILURE OR PERFORMANCE AFFECT CIRCUIT TECHNOLOGY APPLICATIONS ENGINEERING FOR ASSISTANCE.

**APPROVALS**  
 FOR DES: RZ  
 FOR FEM: YIS

**SCALE: NONE**

## SCHEMATIC DIAGRAM

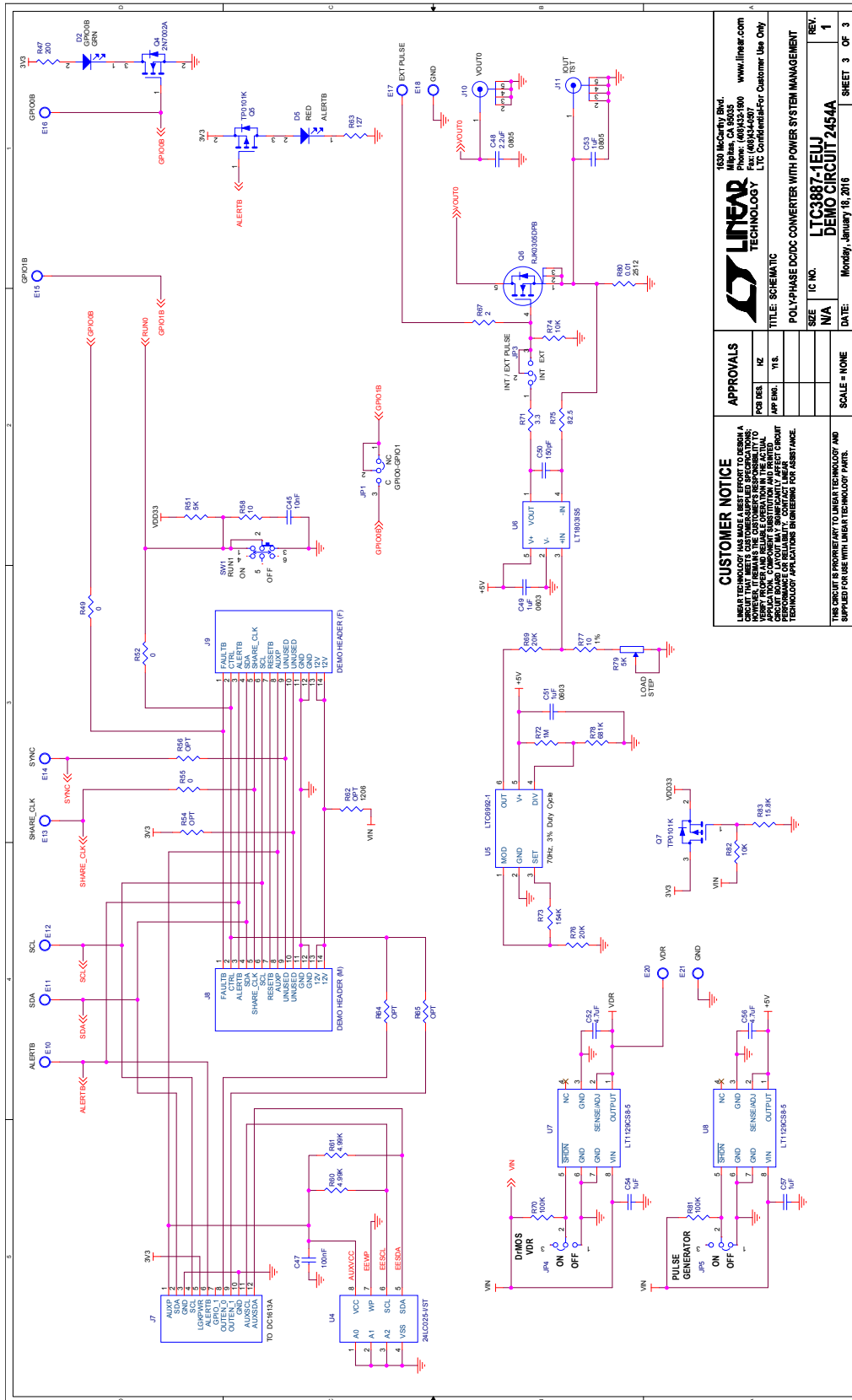

**CUSTOMER NOTICE**  
 LINEAR TECHNOLOGY HAS MADE A BEST EFFORT TO DESIGN A DEMO CIRCUIT THAT WILL OPERATE UNDER REAL-WORLD CONDITIONS. HOWEVER, IT REMAINS THE CUSTOMER'S RESPONSIBILITY TO VERIFY PROPER AND RELIABLE OPERATION IN THE ACTUAL APPLICATION. LINEAR TECHNOLOGY ACCEPTS NO LIABILITY FOR ANY DAMAGE TO EQUIPMENT OR PERSONS THAT MAY BE CAUSED BY THE ACTUAL APPLICATIONS. ENGINEERS SHOULD CONSULT WITH LINEAR TECHNOLOGY APPLICATIONS ENGINEERS FOR ASSISTANCE.

**APPROVALS**

FOR DES.	NZ
APP. ENG.	YIS

**IC NO.** LTC3887-1EUJ  
**DEMO CIRCUIT 2454A**

**SCALE** NONE

**DATE** Monday, January 18, 2016

**REV.** 1

**SHEET 3 OF 3**

**LINEAR TECHNOLOGY**  
 1380 McCarty Blvd.  
 Irvine, CA 92618  
 Phone: (949) 464-1800  
 Fax: (949) 440-0871  
 L1C Confidential-For Customer Use Only

# DEMO MANUAL DC2454A

---

## DEMONSTRATION BOARD IMPORTANT NOTICE

Linear Technology Corporation (LTC) provides the enclosed product(s) under the following **AS IS** conditions:

This demonstration board (DEMO BOARD) kit being sold or provided by Linear Technology is intended for use for **ENGINEERING DEVELOPMENT OR EVALUATION PURPOSES ONLY** and is not provided by LTC for commercial use. As such, the DEMO BOARD herein may not be complete in terms of required design-, marketing-, and/or manufacturing-related protective considerations, including but not limited to product safety measures typically found in finished commercial goods. As a prototype, this product does not fall within the scope of the European Union directive on electromagnetic compatibility and therefore may or may not meet the technical requirements of the directive, or other regulations.

If this evaluation kit does not meet the specifications recited in the DEMO BOARD manual the kit may be returned within 30 days from the date of delivery for a full refund. **THE FOREGOING WARRANTY IS THE EXCLUSIVE WARRANTY MADE BY THE SELLER TO BUYER AND IS IN LIEU OF ALL OTHER WARRANTIES, EXPRESSED, IMPLIED, OR STATUTORY, INCLUDING ANY WARRANTY OF MERCHANTABILITY OR FITNESS FOR ANY PARTICULAR PURPOSE. EXCEPT TO THE EXTENT OF THIS INDEMNITY, NEITHER PARTY SHALL BE LIABLE TO THE OTHER FOR ANY INDIRECT, SPECIAL, INCIDENTAL, OR CONSEQUENTIAL DAMAGES.**

The user assumes all responsibility and liability for proper and safe handling of the goods. Further, the user releases LTC from all claims arising from the handling or use of the goods. Due to the open construction of the product, it is the user's responsibility to take any and all appropriate precautions with regard to electrostatic discharge. Also be aware that the products herein may not be regulatory compliant or agency certified (FCC, UL, CE, etc.).

No License is granted under any patent right or other intellectual property whatsoever. **LTC assumes no liability for applications assistance, customer product design, software performance, or infringement of patents or any other intellectual property rights of any kind.**

LTC currently services a variety of customers for products around the world, and therefore this transaction **is not exclusive**.

**Please read the DEMO BOARD manual prior to handling the product.** Persons handling this product must have electronics training and observe good laboratory practice standards. **Common sense is encouraged.**

This notice contains important safety information about temperatures and voltages. For further safety concerns, please contact a LTC application engineer.

Mailing Address:

Linear Technology  
1630 McCarthy Blvd.  
Milpitas, CA 95035

Copyright © 2004, Linear Technology Corporation