

TPS7A91

1-A, High-Accuracy, Low-Noise LDO Voltage Regulator

1 Features

- 1.0% Accuracy Over Line, Load, and Temperature
- Low Output Noise: 4.7 μV_{RMS} (10 Hz–100 kHz)
- Low Dropout: 200 mV (max) at 1 A
- Wide Input Voltage Range: 1.4 V to 6.5 V
- Wide Output Voltage Range: 0.8 V to 5.2 V
- High Power-Supply Ripple Rejection (PSRR):
 - 70 dB at DC
 - 40 dB at 100 kHz
 - 40 dB at 1 MHz
- Fast Transient Response
- Adjustable Start-Up In-Rush Control with Selectable Soft-Start Charging Current
- Open-Drain Power-Good (PG) Output
- 2.5-mm x 2.5-mm, 10-Pin SON Package

2 Applications

- High-Speed Analog Circuits:
 - VCO, ADC, DAC, LVDS
- Imaging: CMOS Sensors, Video ASICs
- Test and Measurement
- Instrumentation, Medical, and Audio
- Digital Loads: SerDes, FPGA, DSP

3 Description

The TPS7A91 is a low-noise (4.7 μV_{RMS}), low-dropout (LDO) voltage regulator capable of sourcing 1 A with only 200 mV of maximum dropout.

The TPS7A91 output is adjustable with external resistors from 0.8 V to 5.2 V. The TPS7A91 wide input-voltage range supports operation as low as 1.4 V and up to 6.5 V.

With 1% output voltage accuracy (over line, load, and temperature) and soft-start capabilities to reduce in-rush current, the TPS7A91 is ideal for powering sensitive analog low-voltage devices [such as voltage-controlled oscillators (VCOs), analog-to-digital converters (ADCs), digital-to-analog converters (DACs), high-end processors, and field-programmable gate arrays (FPGAs)].

The TPS7A91 is designed to power noise-sensitive components such as those found in high-speed communication, video, medical, or test and measurement applications. The very low 4.7- μV_{RMS} output noise and wideband PSRR (40 dB at 1 MHz) minimizes phase noise and clock jitter. These features maximize performance of clocking devices, ADCs, and DACs.

Device Information⁽¹⁾

PART NUMBER	PACKAGE	BODY SIZE (NOM)
TPS7A91	SON (10)	2.50 mm x 2.50 mm

(1) For all available packages, see the orderable addendum at the end of the datasheet.

Typical Application Circuit

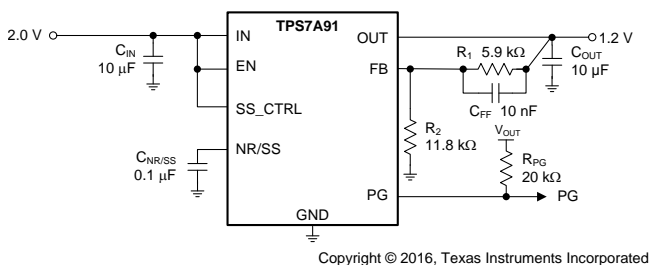

Typical Application Diagram

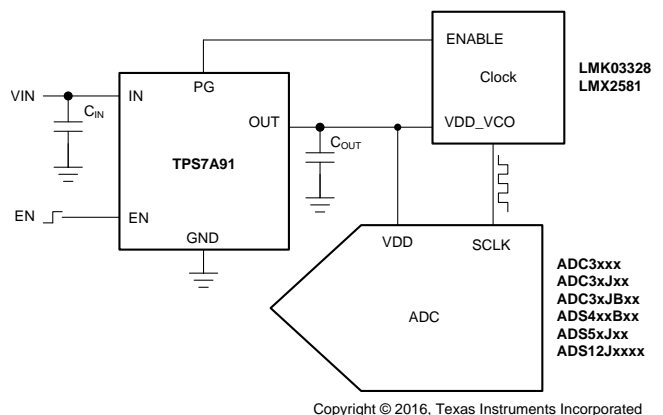

Table of Contents

1 Features	1	8 Application and Implementation	17
2 Applications	1	8.1 Application Information.....	17
3 Description	1	8.2 Typical Application	21
4 Revision History	2	9 Power Supply Recommendations	22
5 Pin Configuration and Functions	3	10 Layout	22
6 Specifications	4	10.1 Layout Guidelines	22
6.1 Absolute Maximum Ratings	4	10.2 Layout Example	23
6.2 ESD Ratings.....	4	11 Device and Documentation Support	24
6.3 Recommended Operating Conditions	4	11.1 Device Support	24
6.4 Thermal Information	4	11.2 Documentation Support	24
6.5 Electrical Characteristics.....	5	11.3 Receiving Notification of Documentation Updates	24
6.6 Typical Characteristics	6	11.4 Community Resources.....	25
7 Detailed Description	12	11.5 Trademarks	25
7.1 Overview	12	11.6 Electrostatic Discharge Caution.....	25
7.2 Functional Block Diagram	12	11.7 Glossary	25
7.3 Feature Description.....	12	12 Mechanical, Packaging, and Orderable	
7.4 Device Functional Modes.....	16	Information	25

4 Revision History

DATE	REVISION	NOTES
December 2016	*	Initial release.

5 Pin Configuration and Functions

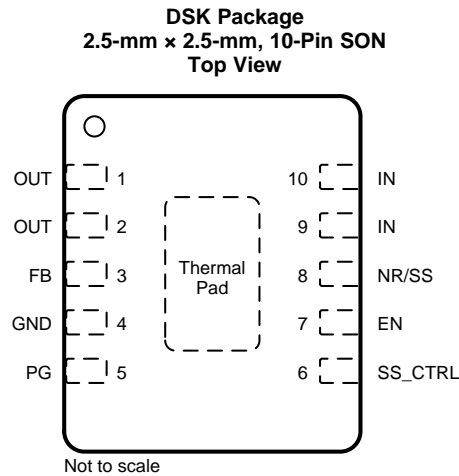

Pin Functions

PIN			DESCRIPTION
NAME	NO.	I/O	
EN	7	I	Enable pin. This pin turns the LDO on and off. If $V_{EN} \geq V_{IH(EN)}$, the regulator is enabled. If $V_{EN} \leq V_{IL(EN)}$, the regulator is disabled. The EN pin must be connected to IN if the enable function is not used.
FB	3	I	Feedback pin. This pin is the input to the control loop error amplifier and is used to set the output voltage of the device.
GND	4	—	Device GND. Connect to the device thermal pad.
IN	9, 10	I	Input pin. A 10 μ F or greater input capacitor is required.
NR/SS	8	—	Noise reduction pin. Connect this pin to an external capacitor to bypass the noise generated by the internal band-gap reference. The capacitor reduces the output noise to very low levels and sets the output ramp rate to limit inrush current.
OUT	1, 2	O	Regulated output. A 10 μ F or greater capacitor must be connected from this pin to GND for stability.
PG	5	O	Open-drain power-good indicator pin for the LDO output voltage. A 10-k Ω to 100-k Ω external pullup resistor is required. This pin can be left floating or connected to GND if not used.
SS_CTRL	6	I	Soft-start control pin. Connect this pin either to GND or IN to change the NR/SS capacitor charging current. If a $C_{NR/SS}$ capacitor is not used, SS_CTRL must be connected to GND to avoid output overshoot.
Thermal pad		—	Connect the thermal pad to the printed circuit board (PCB) ground plane, for an example layout see Figure 42 .

6 Specifications

6.1 Absolute Maximum Ratings

over operating junction temperature range and all voltages with respect to GND (unless otherwise noted)⁽¹⁾

		MIN	MAX	UNIT
Voltage	IN, PG, EN	-0.3	7.0	V
	IN, PG, EN (5% duty cycle, pulse duration ≤ 200 μs)	-0.3	7.5	
	OUT	-0.3	V _{IN} + 0.3	
	SS_CTRL	-0.3	V _{IN} + 0.3	
	NR/SS, FB	-0.3	3.6	
Current	OUT	Internally limited		A
	PG (sink current into the device)	5		mA
Temperature	Operating junction, T _J	-55	150	°C
	Storage, T _{stg}	-55	150	°C

- (1) Stresses beyond those listed under *Absolute Maximum Ratings* may cause permanent damage to the device. These are stress ratings only, which do not imply functional operation of the device at these or any other conditions beyond those indicated under *Recommended Operating Conditions*. Exposure to absolute-maximum-rated conditions for extended periods may affect device reliability.

6.2 ESD Ratings

		VALUE	UNIT
V _(ESD)	Electrostatic discharge	Human body model (HBM), per ANSI/ESDA/JEDEC JS-001 ⁽¹⁾	±2000
		Charged device model (CDM), per JEDEC specification JESD22-C101 ⁽²⁾	±500

- (1) JEDEC document JEP155 states that 500-V HBM allows safe manufacturing with a standard ESD control process.
 (2) JEDEC document JEP157 states that 250-V CDM allows safe manufacturing with a standard ESD control process.

6.3 Recommended Operating Conditions

over operating junction temperature range (unless otherwise noted)

		MIN	MAX	UNIT
V _{IN}	Input supply voltage range	1.4	6.5	V
V _{OUT}	Output voltage range	0.8	5.2	V
I _{OUT}	Output current	0	1	A
C _{IN}	Input capacitor	10		μF
C _{OUT}	Output capacitor	10		μF
C _{NR/SS}	Noise-reduction capacitor	0	10	μF
C _{FF}	Feedforward capacitor	0	100	nF
R _{PG}	Power-good pullup resistance	10	100	kΩ
T _J	Junction temperature	-40	125	°C

6.4 Thermal Information

THERMAL METRIC ⁽¹⁾		TPS7A91	UNIT
		DSK (SON)	
		10 PINS	
R _{θJA}	Junction-to-ambient thermal resistance	56.9	°C/W
R _{θJC(top)}	Junction-to-case (top) thermal resistance	46.3	°C/W
R _{θJB}	Junction-to-board thermal resistance	29.1	°C/W
Ψ _{JT}	Junction-to-top characterization parameter	0.8	°C/W
Ψ _{JB}	Junction-to-board characterization parameter	29.4	°C/W
R _{θJC(bot)}	Junction-to-case (bottom) thermal resistance	3.2	°C/W

- (1) For more information about traditional and new thermal metrics, see the [Semiconductor and IC Package Thermal Metrics](#) application report.

6.5 Electrical Characteristics

over operating temperature range ($T_J = -40^\circ\text{C}$ to $+125^\circ\text{C}$), $1.4\text{ V} \leq V_{IN} \leq 6.5\text{ V}$, $V_{OUT(NOM)} = 0.8\text{ V}$, $I_{OUT} = 5\text{ mA}$, $V_{EN} = 1.4\text{ V}$, $C_{IN} = C_{OUT} = 10\text{ }\mu\text{F}$, $C_{NR/SS} = C_{FF} = 0\text{ nF}$, $SS_CTRL = \text{GND}$, and PG pin pulled up to V_{IN} with $100\text{ k}\Omega$ (unless otherwise noted); typical values are at $T_J = 25^\circ\text{C}$

PARAMETER		TEST CONDITIONS	MIN	TYP	MAX	UNIT
V_{IN}	Input supply voltage range		1.4		6.5	V
V_{REF}	Reference voltage			0.8		V
V_{UVLO}	Input supply UVLO	V_{IN} rising		1.31	1.39	V
$V_{HYS(UVLO)}$	Input supply UVLO hysteresis			290		mV
V_{OUT}	Output voltage range		0.8		5.2	V
	Output voltage accuracy ⁽¹⁾	$1.4\text{ V} \leq V_{IN} \leq 6.5\text{ V}$, $5\text{ mA} \leq I_{OUT} \leq 1\text{ A}$	-1.0%		1.0%	
$\Delta V_{OUT(\Delta V_{IN})}$	Line regulation			0.005		%/V
$\Delta V_{OUT(\Delta I_{OUT})}$	Load regulation ⁽²⁾	$5\text{ mA} \leq I_{OUT} \leq 1\text{ A}$		0.02		%/A
V_{DO}	Dropout voltage	$V_{IN} \geq 1.4\text{ V}$, $I_{OUT} = 1\text{ A}$, $V_{FB} = 0.8\text{ V} - 3\%$			200	mV
I_{LIM}	Output current limit	V_{OUT} forced at $0.9 \times V_{OUT(NOM)}$, $V_{IN} = V_{OUT(NOM)} + 300\text{ mV}$	1.5	1.7	1.9	A
I_{GND}	GND pin current	$V_{IN} = 6.5\text{ V}$, $I_{OUT} = 5\text{ mA}$		2.1	3.5	mA
		$V_{IN} = 1.4\text{ V}$, $I_{OUT} = 1\text{ A}$			4	
I_{SDN}	Shutdown GND pin current	PG = (open), $V_{IN} = 6.5\text{ V}$, $V_{EN} = 0.4\text{ V}$		0.1	15	μA
I_{EN}	EN pin current	$V_{IN} = 6.5\text{ V}$, $0\text{ V} \leq V_{EN} \leq 6.5\text{ V}$	-0.2		0.2	μA
$V_{IL(EN)}$	EN pin low-level input voltage (device disabled)		0		0.4	V
$V_{IH(EN)}$	EN pin high-level input voltage (device enabled)		1.1		6.5	V
I_{SS_CTRL}	SS_CTRL pin current	$V_{IN} = 6.5\text{ V}$, $0\text{ V} \leq V_{SS_CTRL} \leq 6.5\text{ V}$	-0.2		0.2	μA
$V_{IT(PG)}$	PG pin threshold	For PG transitioning low with falling V_{OUT} , expressed as a percentage of $V_{OUT(NOM)}$	82%	88.9%	93%	
$V_{HYS(PG)}$	PG pin hysteresis	For PG transitioning high with rising V_{OUT} , expressed as a percentage of $V_{OUT(NOM)}$		1%		
$V_{OL(PG)}$	PG pin low-level output voltage	$V_{OUT} < V_{IT(PG)}$, $I_{PG} = -1\text{ mA}$ (current into device)			0.4	V
$I_{LKG(PG)}$	PG pin leakage current	$V_{OUT} > V_{IT(PG)}$, $V_{PG} = 6.5\text{ V}$			1	μA
$I_{NR/SS}$	NR/SS pin charging current	$V_{NR/SS} = \text{GND}$, $V_{SS_CTRL} = \text{GND}$	4.0	6.2	9.0	μA
		$V_{NR/SS} = \text{GND}$, $V_{SS_CTRL} = V_{IN}$	65	100	150	
I_{FB}	FB pin leakage current	$V_{IN} = 6.5\text{ V}$, $V_{FB} = 0.8\text{ V}$	-100		100	nA
PSRR	Power-supply ripple rejection	$f = 500\text{ kHz}$, $V_{IN} = 3.8\text{ V}$, $V_{OUT(NOM)} = 3.3\text{ V}$, $I_{OUT} = 750\text{ mA}$, $C_{NR/SS} = 10\text{ nF}$, $C_{FF} = 10\text{ nF}$		39		dB
V_n	Output noise voltage	BW = 10 Hz to 100 kHz, $V_{IN} = 1.8\text{ V}$, $V_{OUT(NOM)} = 0.8\text{ V}$, $I_{OUT} = 1.0\text{ A}$, $C_{NR/SS} = 10\text{ nF}$, $C_{FF} = 10\text{ nF}$		4.7		μV_{RMS}
	Noise spectral density	$f = 10\text{ kHz}$, $V_{IN} = 1.8\text{ V}$, $V_{OUT(NOM)} = 0.8\text{ V}$, $I_{OUT} = 1.0\text{ A}$, $C_{NR/SS} = 10\text{ nF}$, $C_{FF} = 10\text{ nF}$		13		$\text{nV}/\sqrt{\text{Hz}}$
R_{diss}	Output active discharge resistance	$V_{EN} = \text{GND}$		250		Ω
T_{sd}	Thermal shutdown temperature	Shutdown, temperature increasing		160		$^\circ\text{C}$
		Reset, temperature decreasing		140		

(1) When the device is connected to external feedback resistors at the FB pin, external resistor tolerances are not included.

(2) The device is not tested under conditions where $V_{IN} > V_{OUT} + 2.5\text{ V}$ and $I_{OUT} = 1\text{ A}$ because the power dissipation is higher than the maximum rating of the package. Also, this accuracy specification does not apply on any application condition that exceeds the power dissipation limit of the package under test.

6.6 Typical Characteristics

at $T_J = 25^\circ\text{C}$, $1.4\text{ V} \leq V_{IN} \leq 6.5\text{ V}$, $V_{IN} \geq V_{OUT(NOM)} + 0.3\text{ V}$, $V_{OUT} = 0.8\text{ V}$, $SS_CTRL = \text{GND}$, $I_{OUT} = 5\text{ mA}$, $V_{EN} = 1.1\text{ V}$, $C_{OUT} = 10\ \mu\text{F}$, $C_{NR/SS} = C_{FF} = 0\text{ nF}$, PG pin pulled up to V_{OUT} with $100\text{ k}\Omega$, and $SS_CTRL = \text{GND}$ (unless otherwise noted)

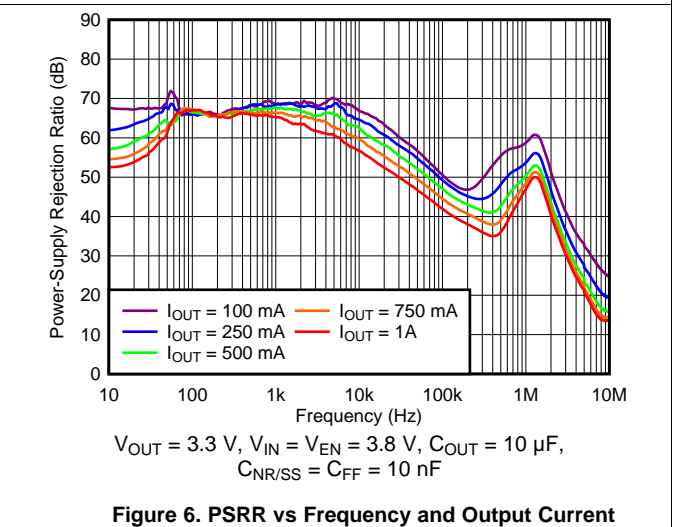
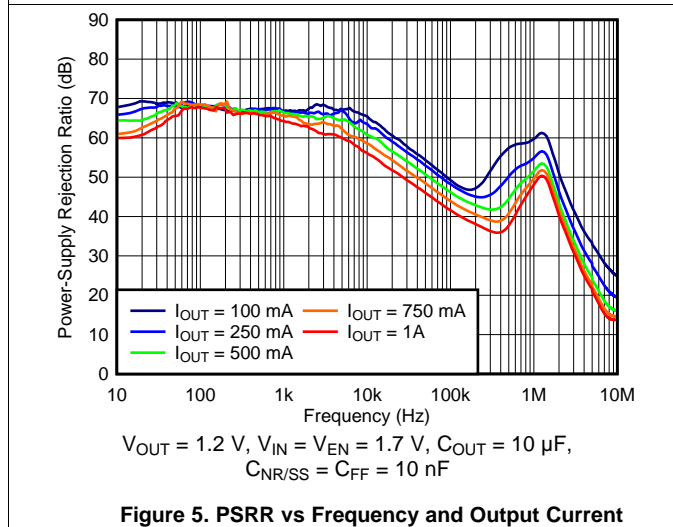
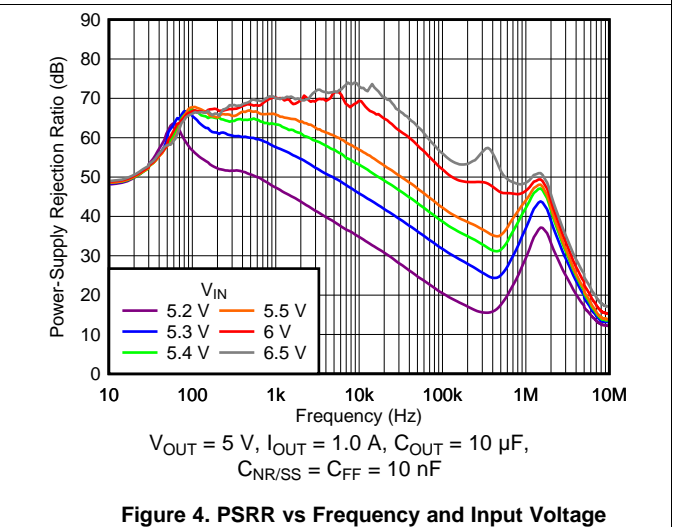
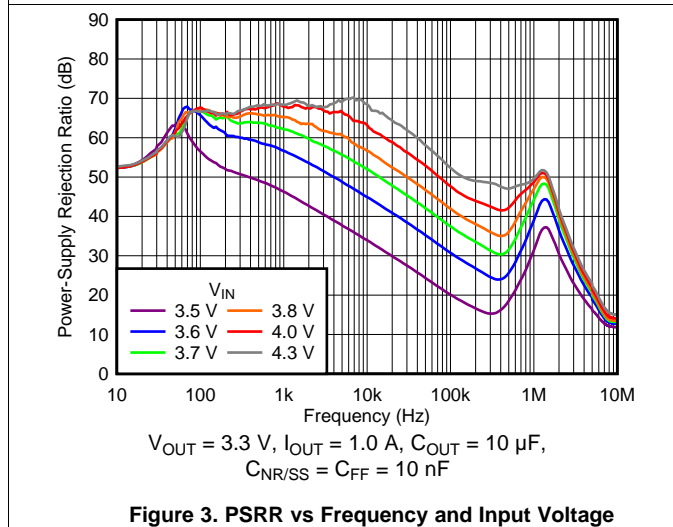
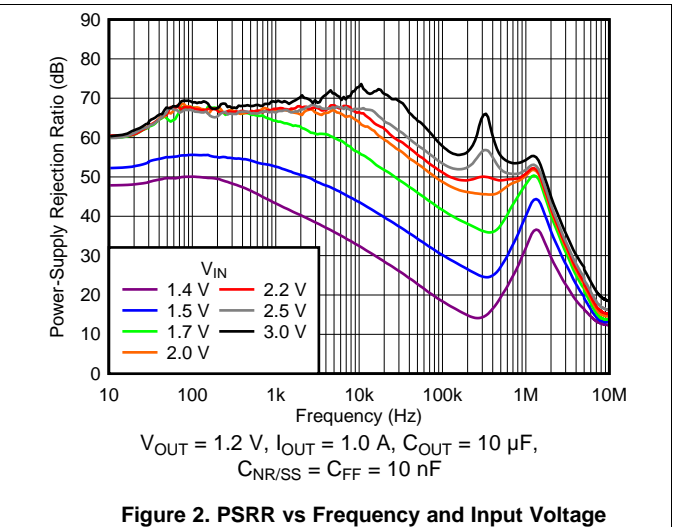
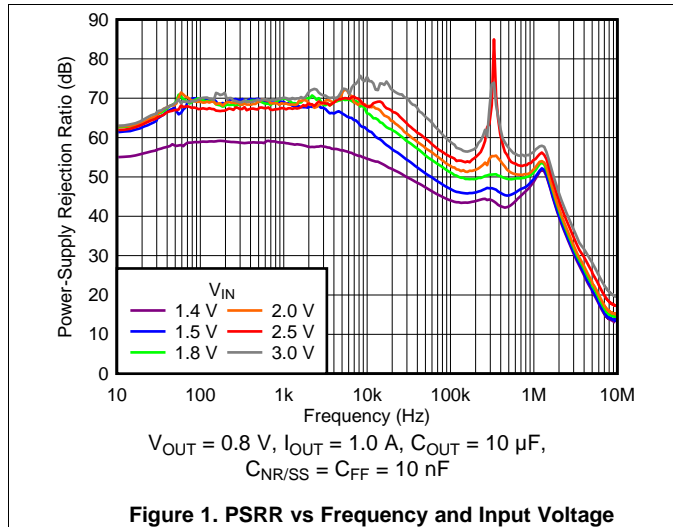

Typical Characteristics (continued)

at $T_J = 25^\circ\text{C}$, $1.4\text{ V} \leq V_{IN} \leq 6.5\text{ V}$, $V_{IN} \geq V_{OUT(NOM)} + 0.3\text{ V}$, $V_{OUT} = 0.8\text{ V}$, $SS_CTRL = \text{GND}$, $I_{OUT} = 5\text{ mA}$, $V_{EN} = 1.1\text{ V}$, $C_{OUT} = 10\ \mu\text{F}$, $C_{NR/SS} = C_{FF} = 0\text{ nF}$, PG pin pulled up to V_{OUT} with $100\text{ k}\Omega$, and $SS_CTRL = \text{GND}$ (unless otherwise noted)

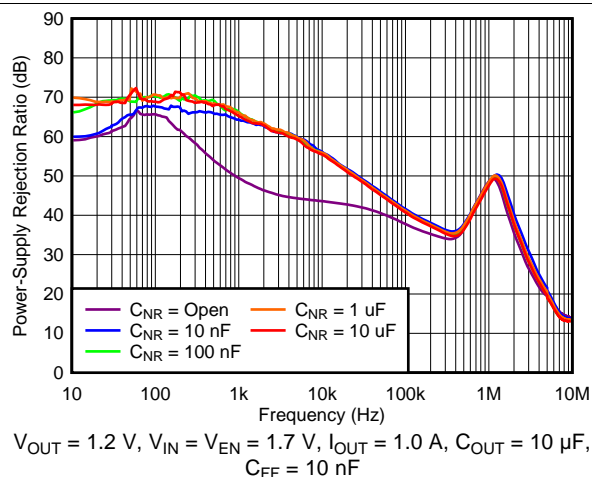

Figure 7. PSRR vs Frequency and $C_{NR/SS}$

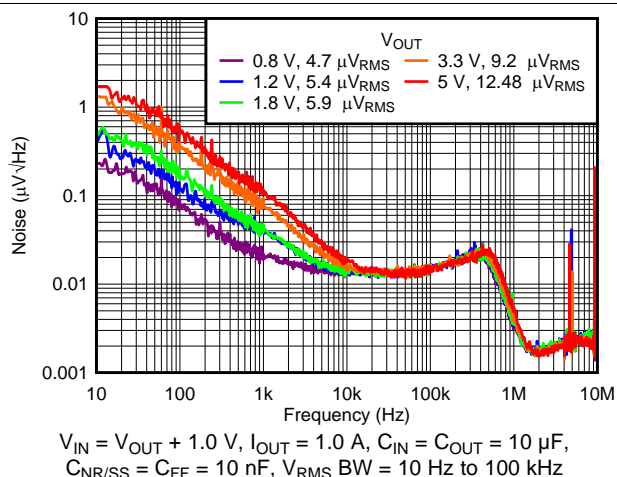

Figure 8. Spectral Noise Density vs Frequency and Output Voltage

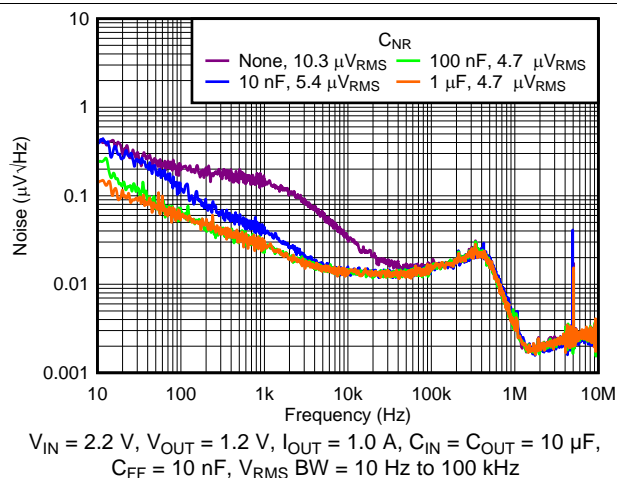

Figure 9. Spectral Noise Density vs Frequency and $C_{NR/SS}$

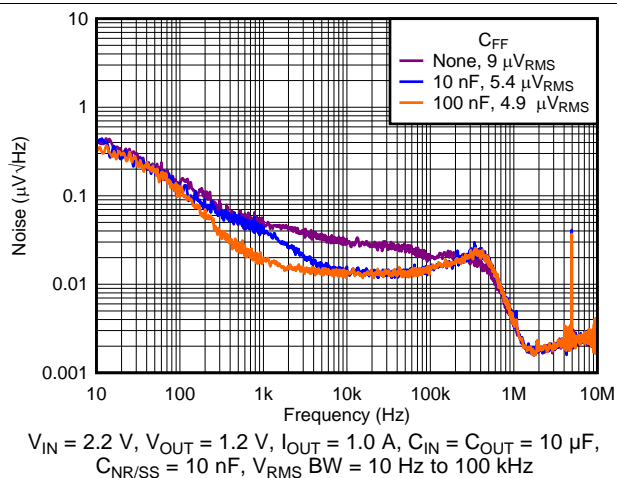

Figure 10. Spectral Noise Density vs Frequency and C_{FF}

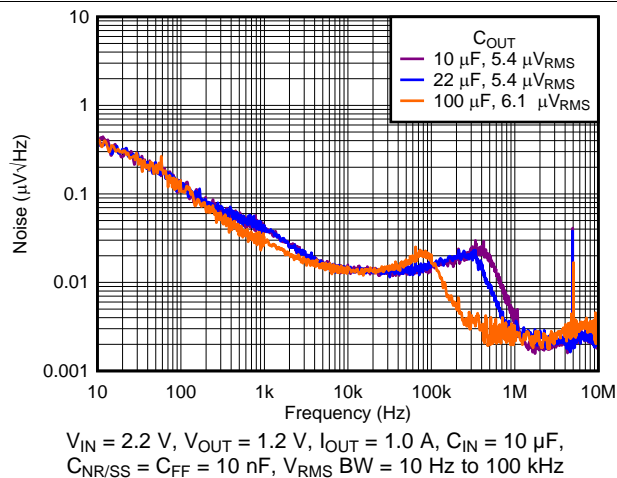

Figure 11. Spectral Noise Density vs Frequency and C_{OUT}

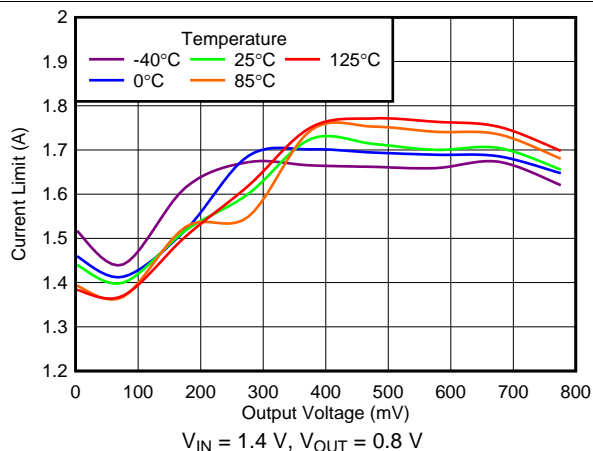

Figure 12. Current Limit Foldback

Typical Characteristics (continued)

at $T_J = 25^\circ\text{C}$, $1.4\text{ V} \leq V_{IN} \leq 6.5\text{ V}$, $V_{IN} \geq V_{OUT(NOM)} + 0.3\text{ V}$, $V_{OUT} = 0.8\text{ V}$, $SS_CTRL = \text{GND}$, $I_{OUT} = 5\text{ mA}$, $V_{EN} = 1.1\text{ V}$, $C_{OUT} = 10\ \mu\text{F}$, $C_{NR/SS} = C_{FF} = 0\text{ nF}$, PG pin pulled up to V_{OUT} with $100\text{ k}\Omega$, and $SS_CTRL = \text{GND}$ (unless otherwise noted)

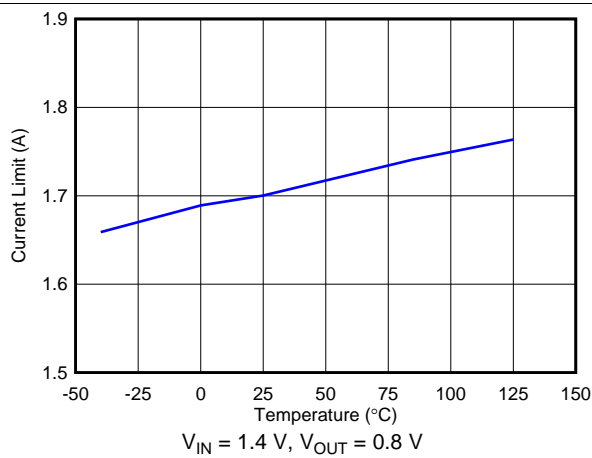

Figure 13. Current Limit vs Temperature

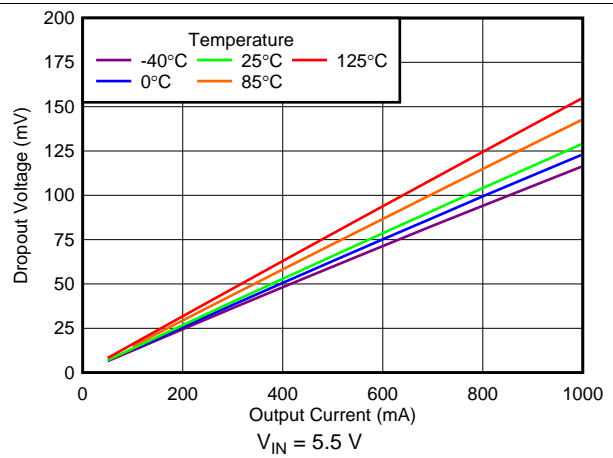

Figure 14. Dropout Voltage vs Output Current

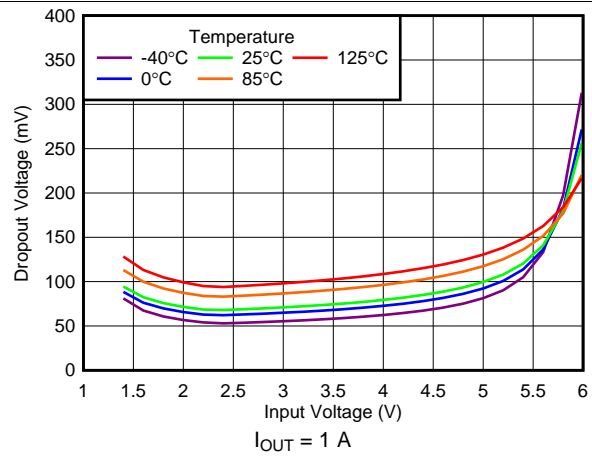

Figure 15. Dropout Voltage vs Input Voltage

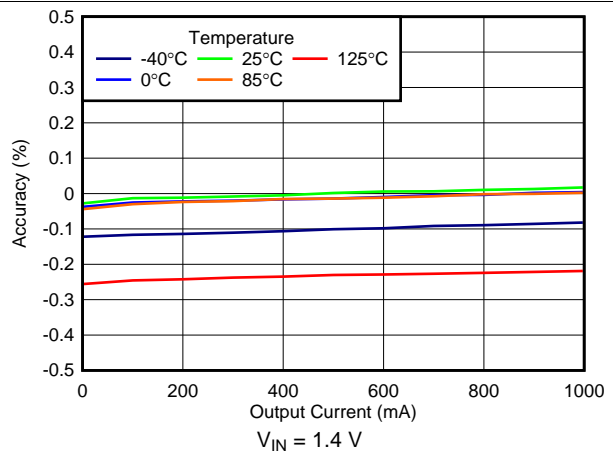

Figure 16. Load Regulation

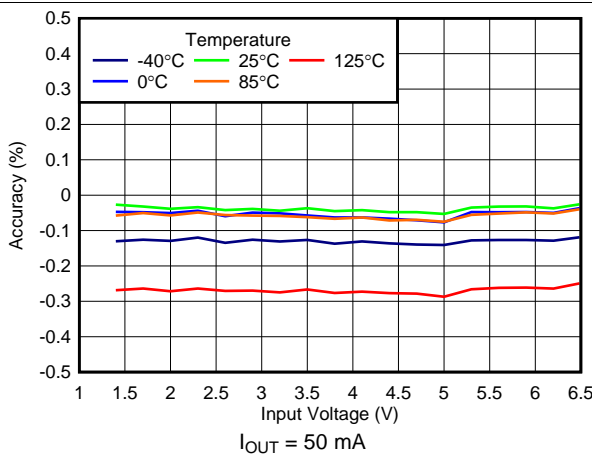

Figure 17. Line Regulation

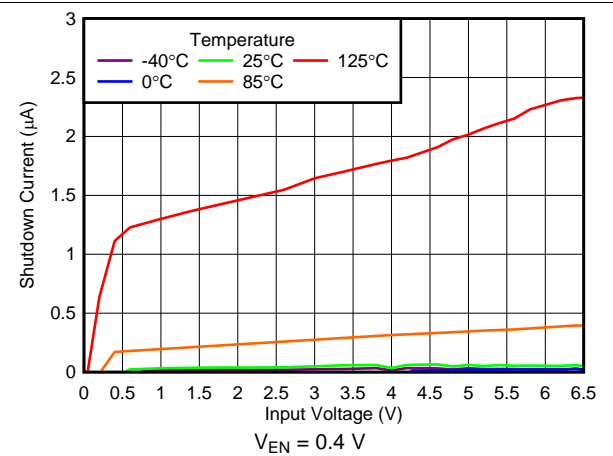

Figure 18. Shutdown Current vs Input Voltage

Typical Characteristics (continued)

at $T_J = 25^\circ\text{C}$, $1.4\text{ V} \leq V_{IN} \leq 6.5\text{ V}$, $V_{IN} \geq V_{OUT(NOM)} + 0.3\text{ V}$, $V_{OUT} = 0.8\text{ V}$, $SS_CTRL = \text{GND}$, $I_{OUT} = 5\text{ mA}$, $V_{EN} = 1.1\text{ V}$, $C_{OUT} = 10\text{ }\mu\text{F}$, $C_{NR/SS} = C_{FF} = 0\text{ nF}$, PG pin pulled up to V_{OUT} with $100\text{ k}\Omega$, and $SS_CTRL = \text{GND}$ (unless otherwise noted)

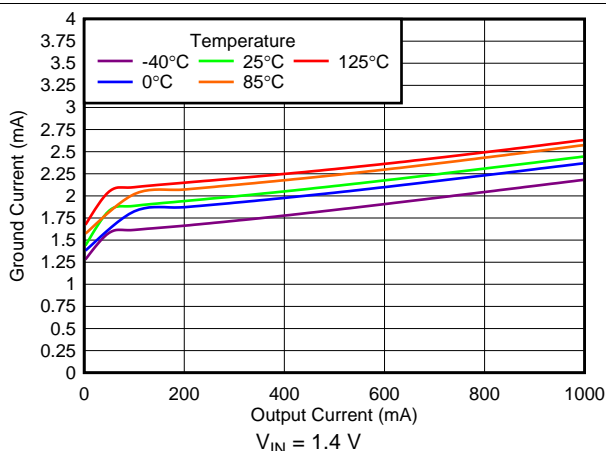

Figure 19. Ground Current vs Output Current

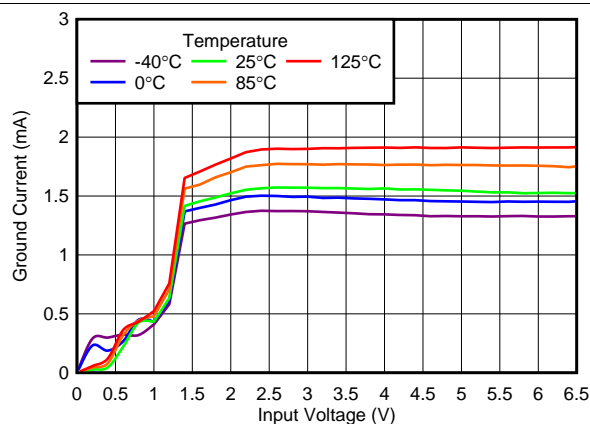

Figure 20. Ground Current vs Input Voltage

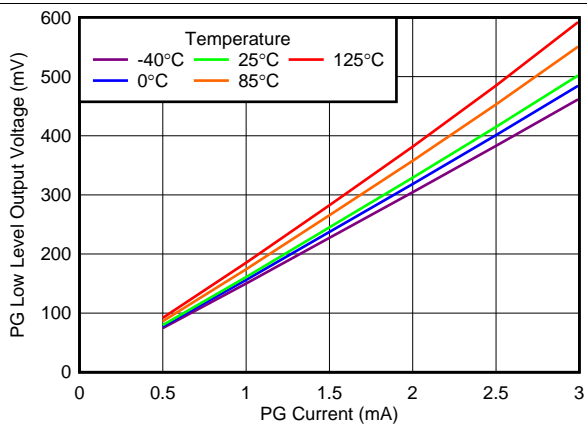

Figure 21. PG Low Level Voltage vs PG Current ($V_{IN} = 1.4\text{ V}$)

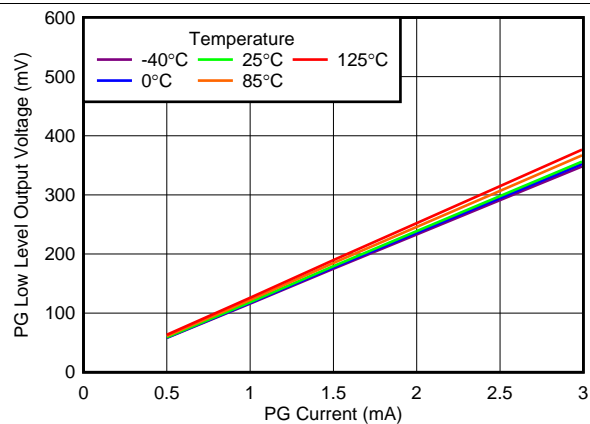

Figure 22. PG Low Level Voltage vs PG Current ($V_{IN} = 6.5\text{ V}$)

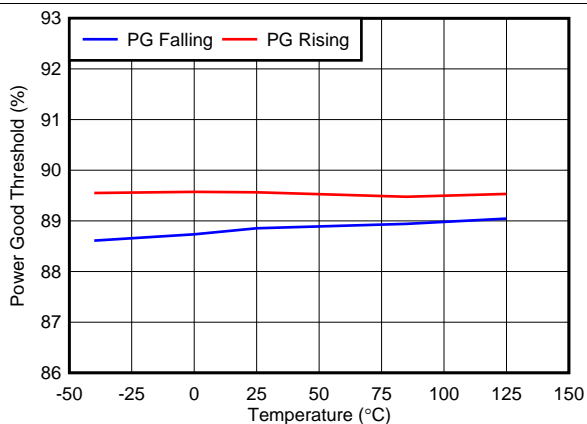

Figure 23. PG Threshold vs Temperature

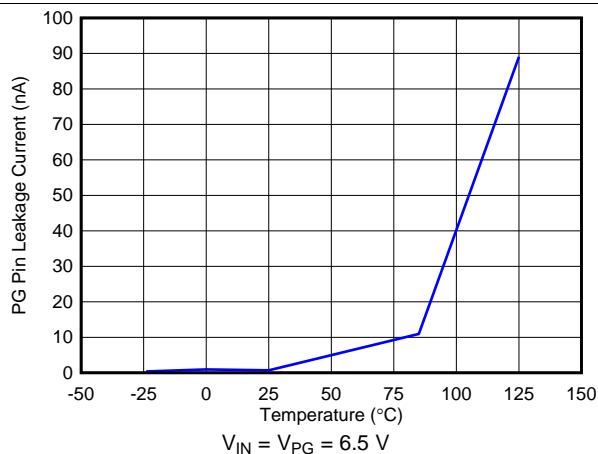

Figure 24. PG Leakage Current vs Temperature

Typical Characteristics (continued)

at $T_J = 25^\circ\text{C}$, $1.4\text{ V} \leq V_{IN} \leq 6.5\text{ V}$, $V_{IN} \geq V_{OUT(NOM)} + 0.3\text{ V}$, $V_{OUT} = 0.8\text{ V}$, $SS_CTRL = \text{GND}$, $I_{OUT} = 5\text{ mA}$, $V_{EN} = 1.1\text{ V}$, $C_{OUT} = 10\ \mu\text{F}$, $C_{NR/SS} = C_{FF} = 0\text{ nF}$, PG pin pulled up to V_{OUT} with $100\text{ k}\Omega$, and $SS_CTRL = \text{GND}$ (unless otherwise noted)

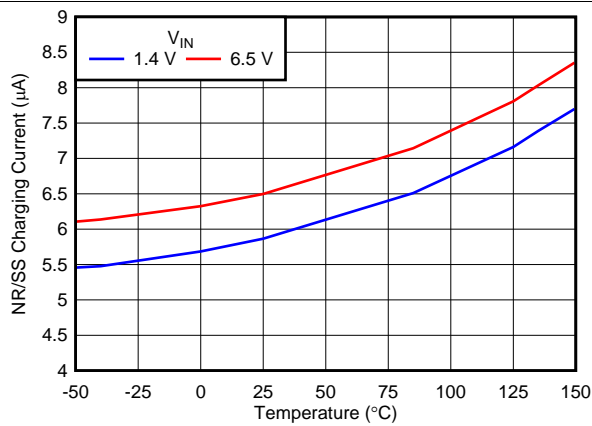

Figure 25. Soft-Start Current vs Temperature (SS_CTRL = GND)

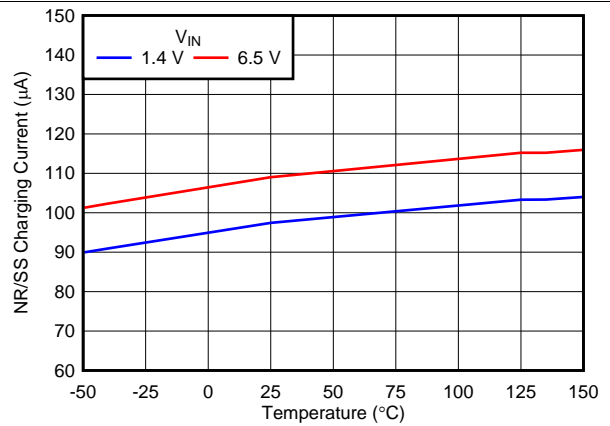

Figure 26. Soft-Start Current vs Temperature (SS_CTRL = V_{IN})

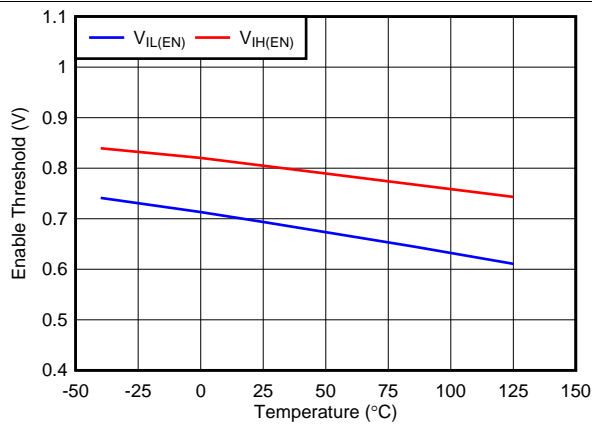

Figure 27. Enable Threshold vs Temperature

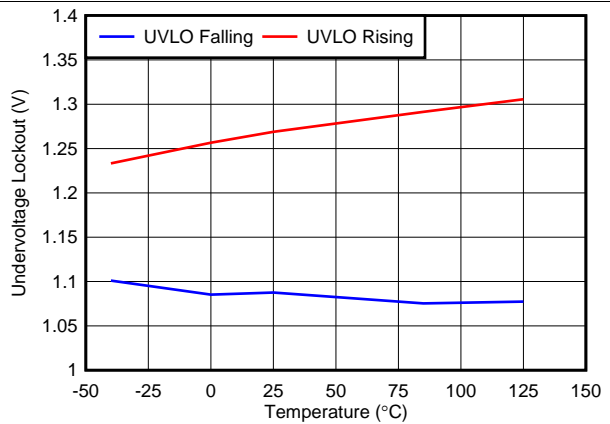
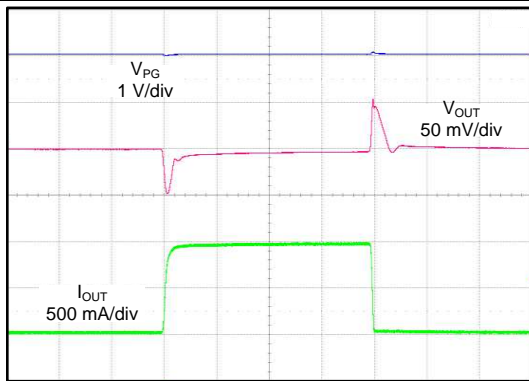
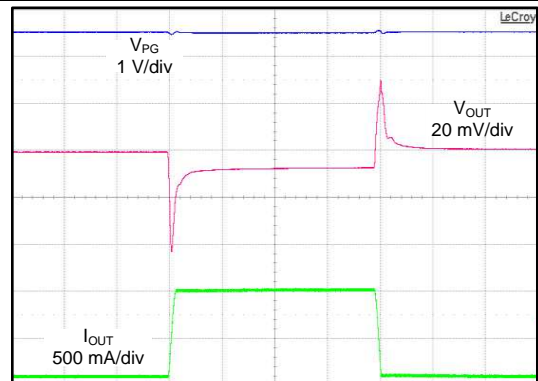

Figure 28. Input UVLO Threshold vs Temperature



Time (10 $\mu\text{s}/\text{div}$)
 $V_{IN} = 1.5\text{ V}$, $I_{OUT} = 100\text{ mA}$ to 1 A to 100 mA at $1\text{ A}/\mu\text{s}$,
 $C_{OUT} = 10\ \mu\text{F}$, $V_{PG} = V_{OUT}$

Figure 29. Load Transient Response ($V_{OUT} = 1.2\text{ V}$)



Time (10 $\mu\text{s}/\text{div}$)
 $V_{IN} = 5.5\text{ V}$, $I_{OUT} = 100\text{ mA}$ to 1 A to 100 mA at $1\text{ A}/\mu\text{s}$,
 $C_{OUT} = 10\ \mu\text{F}$, $V_{PG} = V_{OUT}$

Figure 30. Load Transient Response ($V_{OUT} = 5.0\text{ V}$)

Typical Characteristics (continued)

at $T_J = 25^\circ\text{C}$, $1.4\text{ V} \leq V_{IN} \leq 6.5\text{ V}$, $V_{IN} \geq V_{OUT(NOM)} + 0.3\text{ V}$, $V_{OUT} = 0.8\text{ V}$, $SS_CTRL = \text{GND}$, $I_{OUT} = 5\text{ mA}$, $V_{EN} = 1.1\text{ V}$, $C_{OUT} = 10\text{ }\mu\text{F}$, $C_{NR/SS} = C_{FF} = 0\text{ nF}$, PG pin pulled up to V_{OUT} with $100\text{ k}\Omega$, and $SS_CTRL = \text{GND}$ (unless otherwise noted)

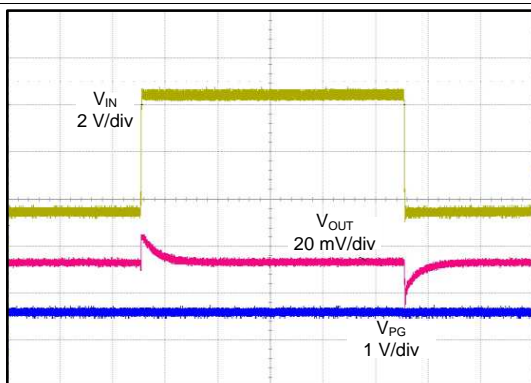

Time (200 $\mu\text{s}/\text{div}$)

$V_{IN} = 1.4\text{ V}$ to 6.5 V to 1.4 V at $2\text{ V}/\mu\text{s}$, $V_{OUT} = 0.8\text{ V}$, $I_{OUT} = 1\text{ A}$, $C_{NR/SS} = C_{FF} = 10\text{ nF}$, $V_{PG} = V_{OUT}$

Figure 31. Line Transient

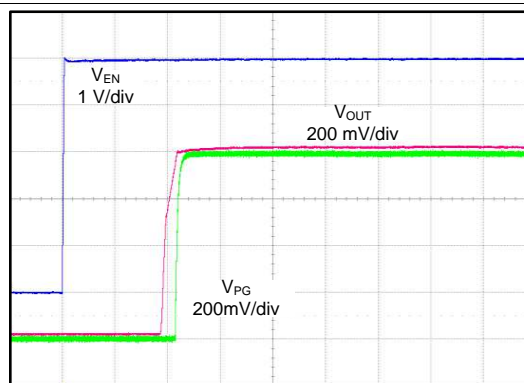

Time (50 $\mu\text{s}/\text{div}$)

$V_{IN} = 1.4\text{ V}$, $V_{PG} = V_{OUT}$

Figure 32. Start-Up ($SS_CTRL = \text{GND}$, $C_{NR/SS} = 0\text{ nF}$)

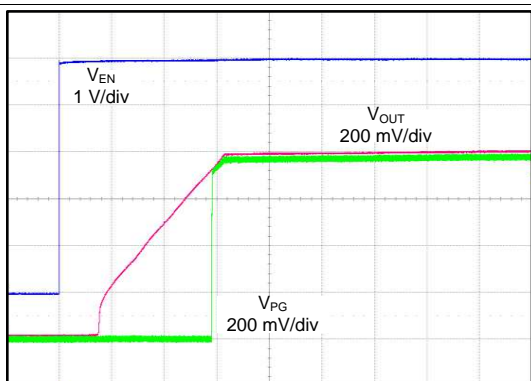

Time (500 $\mu\text{s}/\text{div}$)

$V_{IN} = 1.4\text{ V}$, $V_{PG} = V_{OUT}$

Figure 33. Start-Up ($SS_CTRL = \text{GND}$, $C_{NR/SS} = 10\text{ nF}$)

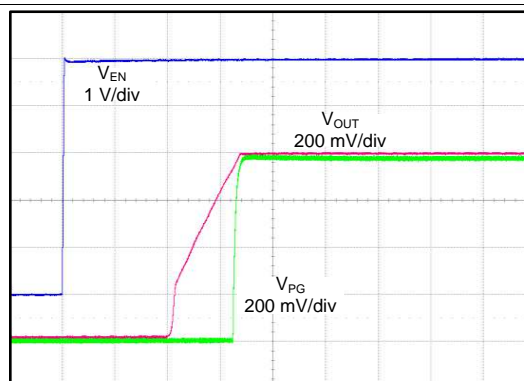

Time (50 $\mu\text{s}/\text{div}$)

$V_{IN} = 1.4\text{ V}$, $V_{PG} = V_{OUT}$

Figure 34. Start-Up ($SS_CTRL = V_{IN}$, $C_{NR/SS} = 10\text{ nF}$)

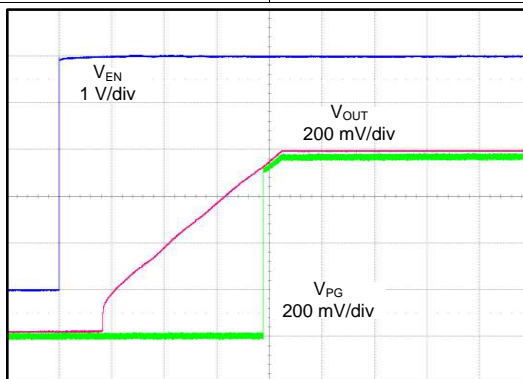

Time (2 ms/div)

$V_{IN} = 1.4\text{ V}$, $V_{PG} = V_{OUT}$

Figure 35. Start-Up ($SS_CTRL = V_{IN}$, $C_{NR/SS} = 1\text{ }\mu\text{F}$)

7 Detailed Description

7.1 Overview

The TPS7A91 is a low-noise, high PSRR, low dropout (LDO) regulator capable of sourcing a 1-A load with only 200 mV of maximum dropout. The TPS7A91 can operate down to a 1.4-V input voltage and a 0.8-V output voltage. This combination of low-noise, high PSRR, and low dropout voltage makes the device an ideal LDO to power a multitude of loads from noise-sensitive communication components in high-speed communications applications to high-end microprocessors or field-programmable gate arrays (FPGAs).

As shown in the [Functional Block Diagram](#) section, the TPS7A91 linear regulator features a low-noise, 0.8-V internal reference that can be filtered externally to obtain even lower output noise. The internal protection circuitry (such as the undervoltage lockout) prevents the device from turning on before the input is high enough to ensure accurate regulation. Foldback current limiting is also included, allowing the output to source the rated output current when the output voltage is in regulation but reduces the allowable output current during short-circuit conditions. The internal power-good detection circuit allows users to sequence down-stream supplies and be alerted if the output voltage is below a regulation threshold.

7.2 Functional Block Diagram

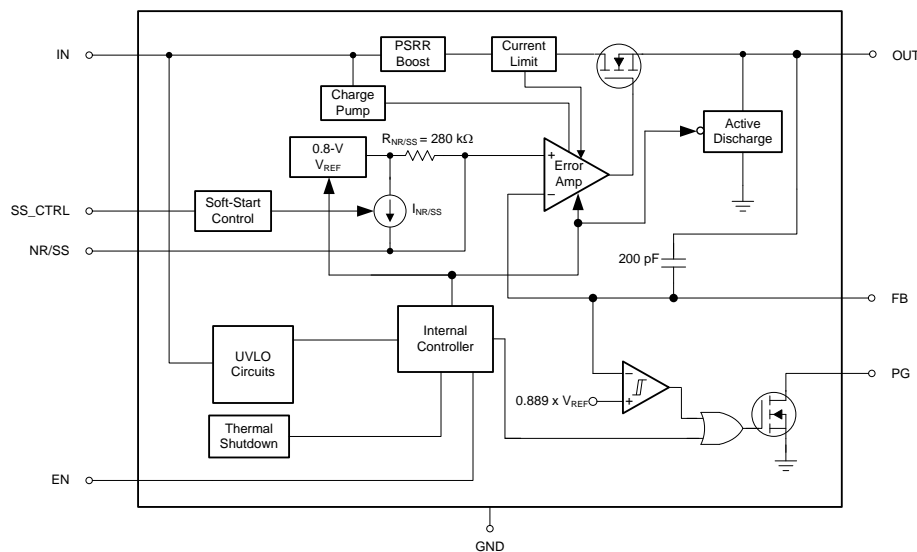

7.3 Feature Description

7.3.1 Output Enable

The enable pin for the TPS7A91 is active high. The output voltage is enabled when the enable pin voltage is greater than $V_{IH(EN)}$ and disabled with the enable pin voltage is less than $V_{IL(EN)}$. If independent control of the output voltage is not needed, then connect the enable pin to the input.

The TPS7A91 has an internal pulldown MOSFET that connects a discharge resistor from V_{OUT} to ground when the device is disabled to actively discharge the output voltage.

7.3.2 Dropout Voltage (V_{DO})

Dropout voltage (V_{DO}) is defined as the $V_{IN} - V_{OUT}$ voltage at the rated current (I_{RATED}) of 1 A, where the pass-FET is fully on and in the ohmic region of operation. V_{DO} indirectly specifies a minimum input voltage above the nominal programmed output voltage at which the output voltage is expected to remain in regulation. If the input falls below the nominal output regulation, then the output follows the input.

Feature Description (continued)

Dropout voltage is determined by the $R_{DS(ON)}$ of the pass-FET. Therefore, if the LDO operates below the rated current, then the V_{DO} for that current scales accordingly. The $R_{DS(ON)}$ for the TPS7A91 can be calculated using Equation 1:

$$R_{DS(ON)} = \frac{V_{DO}}{I_{RATED}} \quad (1)$$

7.3.3 Output Voltage Accuracy

Output voltage accuracy specifies minimum and maximum output voltage error, relative to the expected nominal output voltage stated as a percent. The TPS7A91 features an output voltage accuracy of 1% that includes the errors introduced by the internal reference, load regulation, and line regulation variance across the full range of rated load and line operating conditions over temperature, as specified by the [Electrical Characteristics](#) table. Output voltage accuracy also accounts for all variations between manufacturing lots.

7.3.4 High Power-Supply Ripple Rejection (PSRR)

PSRR is a measure of how well the LDO control loop rejects noise from the input source to make the dc output voltage as noise-free as possible across the frequency spectrum (usually measured from 10 Hz to 10 MHz). Even though PSRR is a loss in noise signal amplitude, the PSRR curves in the [Typical Characteristics](#) section are shown as positive values in decibels (dB) for convenience. Equation 2 gives the PSRR calculation as a function of frequency where input noise voltage [$V_{IN}(f)$] and output noise voltage [$V_{OUT}(f)$] are the amplitudes of the respective sinusoidal signals.

$$PSRR \text{ (dB)} = 20 \text{ Log}_{10} \left(\frac{V_{IN}(f)}{V_{OUT}(f)} \right) \quad (2)$$

Noise that couples from the input to the internal reference voltage is a primary contributor to reduced PSRR performance. Using a noise-reduction capacitor is recommended to filter unwanted noise from the input voltage, which creates a low-pass filter with an internal resistor to improve PSRR performance at lower frequencies.

LDOs are often employed not only as a step-down regulators, but also to provide exceptionally clean power rails for noise-sensitive components. This usage is especially true for the TPS7A91, which features an innovative circuit to boost the PSRR between 200 kHz and 1 MHz. This boost circuit helps further filter switching noise from switching-regulators that operate in this region; see [Figure 1](#). To achieve the maximum benefit of this PSRR boost circuit, using a capacitor with a minimum impedance in the 100-kHz to 1-MHz band is recommended.

7.3.5 Low Output Noise

LDO noise is defined as the internally-generated intrinsic noise created by the semiconductor circuits. The TPS7A91 is designed for system applications where minimizing noise on the power-supply rail is critical to system performance. This scenario is the case for phase-locked loop (PLL)-based clocking circuits where minimum phase noise is all important, or in test and measurement systems where even small power-supply noise fluctuations can distort instantaneous measurement accuracy.

The TPS7A91 includes a low-noise reference ensuring minimal output noise in normal operation. Further improvements can be made by adding a noise reduction capacitor ($C_{NR/SS}$), a feedforward capacitor (C_{FF}), or a combination of the two. See the [Noise-Reduction and Soft-Start Capacitor \(\$C_{NR/SS}\$ \)](#) and [Feed-Forward Capacitor \(\$C_{FF}\$ \)](#) sections for additional design information.

For more information on noise and noise measurement, see the [How to Measure LDO Noise white paper \(SLYY076\)](#).

7.3.6 Output Soft-Start Control

Soft-start refers to the ramp-up characteristic of the output voltage during LDO turn-on after the EN and UVLO thresholds are exceeded. The noise-reduction capacitor ($C_{NR/SS}$) serves a dual purpose of both governing output noise reduction and programming the soft-start ramp during turn-on. Larger values for the noise-reduction capacitors decrease the noise but also result in a slower output turn-on ramp rate.

Feature Description (continued)

The TPS7A91 features an SS_CTRL pin. When the SS_CTRL pin is grounded, the charging current for the NR/SS pin is 6.2 μA (typ); when this pin is connected to IN, the charging current for the NR/SS pin is increased to 100 μA (typ). The higher current allows the use of a much larger noise-reduction capacitor and maintains a reasonable startup time. Figure 36 shows a simplified block diagram of the soft-start circuit. The switch SW is opened to turn off the $I_{\text{NR/SS}}$ current source after V_{FB} reaches approximately 97% of V_{REF} . The final 3% of $V_{\text{NR/SS}}$ is charged through the noise reduction resistor (R_{NR}), which creates an RC delay. R_{NR} is approximately 280 k Ω and applications that require the highest accuracy when using a large value $C_{\text{NR/SS}}$ must take this RC delay into account.

If a noise-reduction capacitor is not used on the NR/SS pin, tying the SS_CTRL pin to the IN pin can result in output voltage overshoot of approximately 10%. This overshoot is minimized by either connecting the SS_CTRL pin to GND or using a capacitor on the NR/SS pin.

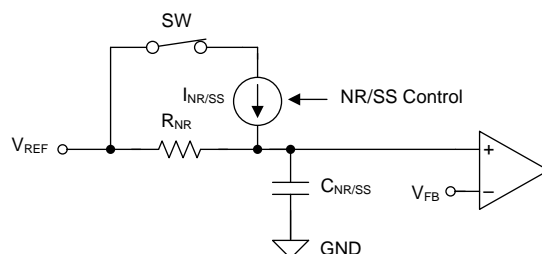

Figure 36. Simplified Soft-Start Circuit

7.3.7 Power-Good Function

The power-good circuit monitors the voltage at the feedback pin to indicate the status of the output voltage. When the feedback pin voltage falls below the PG threshold voltage ($V_{\text{IT(PG)}}$), the PG pin open-drain output engages and pulls the PG pin close to GND. When the feedback voltage exceeds the $V_{\text{IT(PG)}}$ threshold by an amount greater than $V_{\text{HYS(PG)}}$, the PG pin becomes high impedance. By connecting a pullup resistor to an external supply, any downstream device can receive power-good as a logic signal that can be used for sequencing. Make sure that the external pullup supply voltage results in a valid logic signal for the receiving device or devices. Using a pullup resistor from 10 k Ω to 100 k Ω is recommended. Using an external reset device such as the [TPS3890](#) is also recommended in applications where high accuracy is needed or in applications where microprocessor induced resets are needed.

When using a feed-forward capacitor (C_{FF}), the time constant for the LDO startup is increased whereas the power-good output time constant stays the same, possibly resulting in an invalid status of the power-good output. To avoid this issue and to receive a valid PG output, make sure that the time constant of both the LDO startup and the power-good output are matching, which can be done by adding a capacitor in parallel with the power-good pullup resistor. For more information, see the [Pros and Cons of Using a Feedforward Capacitor with a Low-Dropout Regulator application report](#) (SBVA042).

The state of PG is only valid when the device is operating above the minimum input voltage of the device and power good is asserted regardless of the output voltage state when the input voltage falls below the UVLO threshold minus the UVLO hysteresis. Figure 37 illustrates a simplified block diagram of the power-good circuit. When the input voltage falls below approximately 0.8 V, there is not enough gate drive voltage to keep the open-drain, power-good device turned on and the power-good output is pulled high. Connecting the power-good pullup resistor to the output voltage can help minimize this effect.

Feature Description (continued)

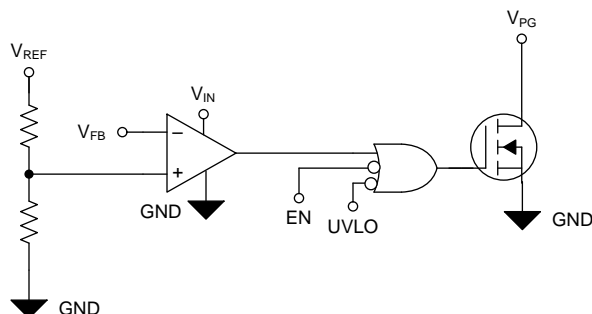

Figure 37. Simplified PG Circuit

7.3.8 Internal Protection Circuitry

7.3.8.1 Undervoltage Lockout (UVLO)

The TPS7A91 has an independent undervoltage lockout (UVLO) circuit that monitors the input voltage, allowing a controlled and consistent turn on and off of the output voltage. To prevent the device from turning off if the input drops during turn on, the UVLO has approximately 290 mV of hysteresis.

The UVLO circuit responds quickly to glitches on V_{IN} and disables the output of the device if this rail starts to collapse too quickly. Use an input capacitor that is large enough to slow input transients to less than two volts per microsecond.

7.3.8.2 Internal Current Limit (I_{CL})

The internal current-limit circuit is used to protect the LDO against transient high-load current faults or shorting events. The LDO is not designed to operate in current limit under steady-state conditions. During an overcurrent event where the output voltage is pulled 10% below the regulated output voltage, the LDO sources a constant current as specified in the [Electrical Characteristics](#) table. When the output voltage falls, the amount of output current is reduced to better protect the device. During a hard short-circuit event, the current is reduced to approximately 1.45 A. See [Figure 12](#) in the [Typical Characteristics](#) section for more information about the current-limit foldback behavior. Note also that when a current-limit event occurs, the LDO begins to heat up because of the increase in power dissipation. The increase in heat can trigger the integrated thermal shutdown protection circuit.

7.3.8.3 Thermal Protection

The TPS7A91 contains a thermal shutdown protection circuit to turn off the output current when excessive heat is dissipated in the LDO. Thermal shutdown occurs when the thermal junction temperature (T_J) of the pass-FET exceeds 160°C (typical). Thermal shutdown hysteresis assures that the LDO again resets (turns on) when the temperature falls to 140°C (typical). The thermal time-constant of the semiconductor die is fairly short, and thus the output turns on and off at a high rate when thermal shutdown is reached until power dissipation is reduced.

The internal protection circuitry of the TPS7A91 is designed to protect against thermal overload conditions. The circuitry is not intended to replace proper heat sinking. Continuously running the TPS7A91 into thermal shutdown degrades device reliability.

For reliable operation, limit junction temperature to a maximum of 125°C. To estimate the thermal margin in a given layout, increase the ambient temperature until the thermal protection shutdown is triggered using worst-case load and highest input voltage conditions. For good reliability, thermal shutdown must occur at least 35°C above the maximum expected ambient temperature condition for the application. This configuration produces a worst-case junction temperature of 125°C at the highest expected ambient temperature and worst-case load.

7.4 Device Functional Modes

Table 1 provides a quick comparison between the normal, dropout, and disabled modes of operation.

Table 1. Device Functional Modes Comparison

OPERATING MODE	PARAMETER			
	V_{IN}	EN	I_{OUT}	T_J
Normal ⁽¹⁾	$V_{IN} > V_{OUT(nom)} + V_{DO}$	$V_{EN} > V_{IH(EN)}$	$I_{OUT} < I_{CL}$	$T_J < T_{sd}$
Dropout ⁽¹⁾	$V_{IN} < V_{OUT(nom)} + V_{DO}$	$V_{EN} > V_{IH(EN)}$	$I_{OUT} < I_{CL}$	$T_J < T_{sd}$
Disabled ⁽²⁾	$V_{IN} < V_{UVLO}$	$V_{EN} < V_{IL(EN)}$	—	$T_J > T_{sd}$

(1) All table conditions must be met.

(2) The device is disabled when any condition is met.

7.4.1 Normal Operation

The device regulates to the nominal output voltage when all of the following conditions are met.

- The input voltage is greater than the nominal output voltage plus the dropout voltage ($V_{OUT(nom)} + V_{DO}$)
- The enable voltage has previously exceeded the enable rising threshold voltage and has not yet decreased below the enable falling threshold
- The output current is less than the current limit ($I_{OUT} < I_{CL}$)
- The device junction temperature is less than the thermal shutdown temperature ($T_J < T_{sd}$)

7.4.2 Dropout Operation

If the input voltage is lower than the nominal output voltage plus the specified dropout voltage, but all other conditions are met for normal operation, the device operates in dropout. In this mode, the output voltage tracks the input voltage. During this mode, the transient performance of the device becomes significantly degraded because the pass device is in a triode state and no longer controls the current through the LDO. Line or load transients in dropout can result in large output-voltage deviations.

When the device is in a steady dropout state (defined as when the device is in dropout, $V_{IN} < V_{OUT(NOM)} + V_{DO}$, right after being in a normal regulation state, but *not* during startup), the pass-FET is driven as hard as possible. When the input voltage returns to $V_{IN} \geq V_{OUT(NOM)} + V_{DO}$, V_{OUT} can overshoot for a short period of time if the input voltage slew rate is greater than 0.1 V/ μ s.

7.4.3 Disabled

The output of the TPS7A91 can be shutdown by forcing the enable pin below 0.4 V. When disabled, the pass device is turned off, internal circuits are shutdown, and the output voltage is actively discharged to ground by an internal resistor from the output to ground.

8 Application and Implementation

NOTE

Information in the following applications sections is not part of the TI component specification, and TI does not warrant its accuracy or completeness. TI's customers are responsible for determining suitability of components for their purposes. Customers should validate and test their design implementation to confirm system functionality.

8.1 Application Information

The TPS7A91 is a linear voltage regulator operating from 1.4 V to 6.5 V on the input and regulates voltages between 0.8 V to 5.0 V within 1% accuracy and a 1-A maximum output current. Efficiency is defined by the ratio of output voltage to input voltage because the TPS7A91 is a linear voltage regulator. To achieve high efficiency, the dropout voltage ($V_{IN} - V_{OUT}$) must be as small as possible, thus requiring a very low dropout LDO. Successfully implementing an LDO in an application depends on the application requirements. This section discusses key device features and how to best implement them to achieve a reliable design.

8.1.1 Adjustable Output

The output voltage of the TPS7A9101 can be adjusted from 0.8 V to 5.2 V by using a resistor divider network as shown in [Figure 38](#).

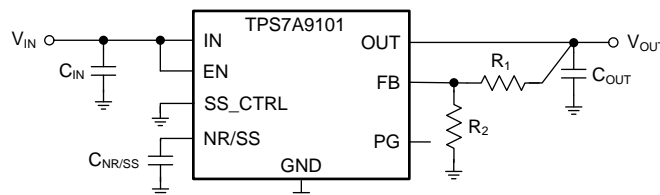

Copyright © 2016, Texas Instruments Incorporated

Figure 38. Adjustable Operation

R_1 and R_2 can be calculated for any output voltage range using [Equation 3](#). This resistive network must provide a current greater than or equal to 5 μ A for optimum noise performance.

$$R_1 = R_2 \left(\frac{V_{OUT}}{V_{REF}} - 1 \right), \quad \text{where } \frac{|V_{REF(max)}|}{R_2} > 5 \mu\text{A} \quad (3)$$

If greater voltage accuracy is required, take into account the output voltage offset contribution resulting from the feedback pin current (I_{FB}) and use 0.1%-tolerance resistors.

[Table 2](#) lists the resistor combination required to achieve a few of the most common rails using commercially-available, 0.1%-tolerance resistors to maximize nominal voltage accuracy and also abiding to the formula given in [Equation 3](#).

Application Information (continued)
Table 2. Recommended Feedback-Resistor Values

V _{OUT(TARGET)} (V)	FEEDBACK RESISTOR VALUES ⁽¹⁾		CALCULATED OUTPUT VOLTAGE (V)
	R ₁ (kΩ)	R ₂ (kΩ)	
0.8	Short	Open	0.800
1.00	2.55	10.2	1.000
1.20	5.9	11.8	1.200
1.50	9.31	10.7	1.496
1.80	1.87	1.5	1.797
1.90	15.8	11.5	1.899
2.50	2.43	1.15	2.490
3.00	3.16	1.15	2.998
3.30	3.57	1.15	3.283
5.00	10.5	2	5.00

(1) R₁ is connected from OUT to FB; R₂ is connected from FB to GND; see [Figure 38](#).

8.1.2 Start-Up
8.1.2.1 Enable (EN) and Undervoltage Lockout (UVLO)

The TPS7A91 only turns on when EN and UVLO are above the respective voltage thresholds. The TPS7A91 has an independent UVLO circuit that monitors the input voltage to allow a controlled and consistent turn on and off. The UVLO has approximately 290 mV of hysteresis to prevent the device from turning off if the input drops during turn on. The EN signal allows independent logic-level turn-on and shutdown of the LDO when the input voltage is present. Connecting EN directly to IN is recommended if independent turn-on is not needed.

The TPS7A91 has an internal pulldown MOSFET that connects a discharge resistor from V_{OUT} to ground when the device is disabled to actively discharge the output voltage.

8.1.2.2 Noise-Reduction and Soft-Start Capacitor (C_{NR/SS})

The C_{NR/SS} capacitor serves a dual purpose of both reducing output noise and setting the soft-start ramp during turn-on.

8.1.2.2.1 Noise Reduction

For low-noise applications, the C_{NR/SS} capacitor forms an RC filter for filtering output noise that is otherwise amplified by the control loop. For low-noise applications, a C_{NR/SS} of between 10 nF to 10 μF is recommended. Larger values for C_{NR/SS} can be used; however, above 1 μF there is little benefit in lowering the output voltage noise for frequencies above 10 Hz.

8.1.2.2.2 Soft-Start and Inrush Current

Soft-start refers to the gradual ramp-up characteristic of the output voltage after the EN and UVLO thresholds are exceeded. Reducing how quickly the output voltage increases during startup also reduces the amount of current needed to charge the output capacitor, referred to as inrush current. Inrush current is defined as the current going into the LDO during start-up. Inrush current consists of the load current, the current used to charge the output capacitor, and the ground pin current (that contributes very little to inrush current). This current is difficult to measure because the input capacitor must be removed, which is not recommended. However, the inrush current can be estimated by [Equation 4](#):

$$I_{OUT}(t) = \left(\frac{C_{OUT} \times dV_{OUT}(t)}{dt} \right) + \left(\frac{V_{OUT}(t)}{R_{LOAD}} \right)$$

where:

- V_{OUT}(t) is the instantaneous output voltage of the turn-on ramp
- dV_{OUT}(t)/dt is the slope of the V_{OUT} ramp and
- R_{LOAD} is the resistive load impedance

(4)

The TPS7A91 features a monotonic, voltage-controlled soft-start that is set by the user with an external capacitor ($C_{NR/SS}$). This soft-start helps reduce inrush current, minimizing load transients to the input power bus that can cause potential start-up initialization problems when powering FPGAs, digital signal processors (DSPs), or other high current loads.

To achieve a monotonic start-up, the TPS7A91 error amplifier tracks the voltage ramp of the external soft-start capacitor until the voltage exceeds approximately 97% of the internal reference. The final 3% of $V_{NR/SS}$ is charged through the noise-reduction resistor (R_{NR}), creating an RC delay. R_{NR} is approximately 280 k Ω and applications that require the highest accuracy when using a large value $C_{NR/SS}$ must take this RC delay into account.

The soft-start ramp time depends on the soft-start charging current ($I_{NR/SS}$), the soft-start capacitance ($C_{NR/SS}$), and the internal reference (V_{REF}). The approximate soft-start ramp time (t_{SS}) can be calculated with [Equation 5](#):

$$t_{SS} = (V_{REF} \times C_{NR/SS}) / I_{NR/SS} \quad (5)$$

Note that the value for $I_{NR/SS}$ is determined by the state of the SS_CTRL pin. When the SS_CTRL pin is connected to GND, the typical value for the $I_{NR/SS}$ current is 6.2 μ A. Connecting the SS_CTRL pin to IN increases the typical soft-start charging current to 100 μ A. The larger charging current for $I_{NR/SS}$ is useful if shorter start-up times are needed (such as when using a large noise-reduction capacitor).

8.1.3 Capacitor Recommendation

The TPS7A91 is designed to be stable using low equivalent series resistance (ESR) ceramic capacitors at the input, output, and noise-reduction pin. Multilayer ceramic capacitors have become the industry standard for these types of applications and are recommended, but must be used with good understanding of their limitations. Ceramic capacitors that employ X7R-, X5R-, and COG-rated dielectric materials provide relatively good capacitive stability across temperature, whereas the use of Y5V-rated capacitors is discouraged precisely because the capacitance varies so widely. In all cases, ceramic capacitors vary a great deal with operating voltage and temperature and the design engineer must be aware of these characteristics. As a rule of thumb, ceramic capacitors are recommended to be derated by 50%. The input and output capacitors recommended herein account for a capacitance derating of 50%.

8.1.3.1 Input and Output Capacitor Requirements (C_{IN} and C_{OUT})

The TPS7A91 is designed and characterized for operation with ceramic capacitors of 10 μ F or greater at the input and output. Locate the input and output capacitors as near as practical to the input and output pins to minimize the trace inductance from the capacitor to the device.

Attention must be given to the input capacitance to minimize transient input droop during startup and load current steps. Note that simply using very large ceramic input capacitances can cause unwanted ringing at the output if the input capacitor (in combination with the wire-lead inductance) creates a high-Q peaking effect during transients, which is why short, well-designed interconnect traces to the upstream supply are needed to minimize ringing. Damping of unwanted ringing can be accomplished by using a tantalum capacitor, with a few hundred milliohms of ESR, in parallel with the ceramic input capacitor. The UVLO circuit responds quickly to glitches on V_{IN} and disables the output of the device if this rail starts to collapse too quickly. Use an input capacitor that is large enough to slow input transients to less than two volts per microsecond.

8.1.3.1.1 Load-Step Transient Response

The load-step transient response is the output voltage response by the LDO to a step change in load current. The depth of charge depletion immediately after the load step is directly proportional to the amount of output capacitance. However, although larger output capacitances decrease any voltage dip or peak occurring during a load step, the control-loop bandwidth is also decreased, thereby slowing the response time.

The LDO cannot sink charge, therefore when the output load is removed or greatly reduced, the control loop must turn off the pass-FET and wait for any excess charge to deplete.

8.1.3.2 Feed-Forward Capacitor (C_{FF})

Although a feed-forward capacitor (C_{FF}), from the FB pin to the OUT pin is not required to achieve stability, a 10-nF, feed-forward capacitor improves the noise and PSRR performance. A higher capacitance C_{FF} can be used; however, the startup time is longer and the power-good signal can incorrectly indicate that the output voltage has settled. For a detailed description, see the [Pros and Cons of Using a Feedforward Capacitor with a Low-Dropout Regulator application report](#) (SBVA042).

8.1.4 Power Dissipation (P_D)

Circuit reliability demands that proper consideration be given to device power dissipation, location of the circuit on the printed circuit board (PCB), and correct sizing of the thermal plane. The PCB area around the regulator must be as free as possible of other heat-generating devices that cause added thermal stresses.

To first-order approximation, power dissipation in the regulator depends on the input-to-output voltage difference and load conditions. P_D can be calculated using [Equation 6](#):

$$P_D = (V_{IN} - V_{OUT}) \times I_{OUT} \quad (6)$$

An important note is that power dissipation can be minimized, and thus greater efficiency achieved, by proper selection of the system voltage rails. For the lowest power dissipation use the minimum input voltage necessary for proper output regulation.

The primary heat conduction path for the DSK package is through the thermal pad to the PCB. Solder the thermal pad to a copper pad area under the device. This pad area should contain an array of plated vias that conduct heat to additional copper planes for increased heat dissipation.

The maximum power dissipation determines the maximum allowable ambient temperature (T_A) for the device. Power dissipation and junction temperature are most often related by the junction-to-ambient thermal resistance (θ_{JA}) of the combined PCB and device package and the temperature of the ambient air (T_A), according to [Equation 7](#).

$$T_J = T_A + (\theta_{JA} \times P_D) \quad (7)$$

Unfortunately, the thermal resistance (θ_{JA}) is highly dependent on the heat-spreading capability built into the particular PCB design, and therefore varies according to the total copper area, copper weight, and location of the planes. The θ_{JA} recorded in the [Thermal Information](#) table is determined by the JEDEC standard, PCB, and copper-spreading area and is only used as a relative measure of package thermal performance.

8.1.5 Estimating Junction Temperature

The JEDEC standard now recommends the use of psi (Ψ) thermal metrics to estimate the junction temperatures of the LDO when in-circuit on a typical PCB board application. These metrics are not strictly speaking thermal resistances, but rather offer practical and relative means of estimating junction temperatures. These psi metrics are determined to be significantly independent of the copper-spreading area. The key thermal metrics (Ψ_{JT} and Ψ_{JB}) are given in the [Thermal Information](#) table and are used in accordance with [Equation 8](#).

$$\Psi_{JT}: T_J = T_T + \Psi_{JT} \times P_D$$

$$\Psi_{JB}: T_J = T_B + \Psi_{JB} \times P_D$$

where:

- P_D is the power dissipated as explained in [Equation 6](#)
 - T_T is the temperature at the center-top of the device package and
 - T_B is the PCB surface temperature measured 1 mm from the device package and centered on the package edge
- (8)

For a more detailed discussion on thermal metrics and how to use them, see the [Semiconductor and IC Package Thermal Metrics application report](#) (SPRA953).

8.2 Typical Application

This section discusses the implementation of the TPS7A91 to regulate from a 2-V input voltage to a 1.2-V output voltages for noise-sensitive loads. The schematic for this application circuit is provided in [Figure 39](#).

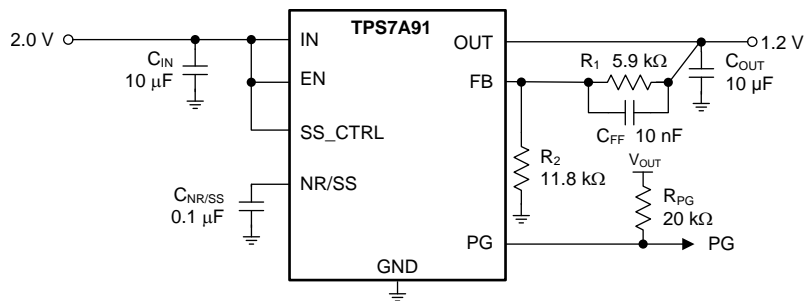

Copyright © 2016, Texas Instruments Incorporated

Figure 39. Application Example

8.2.1 Design Requirements

For the design example shown in [Figure 39](#), use the parameters listed in [Table 3](#) as the input parameters.

Table 3. Design Parameters

PARAMETER	APPLICATION REQUIREMENTS	DESIGN RESULTS
Input voltages (V_{IN})	2 V, $\pm 3\%$, provided by the dc-dc converter switching at 750 kHz	1.4 V to 6.5 V
Maximum ambient operating temperature	55°C	101°C junction temperature
Output voltages (V_{OUT})	1.2 V, $\pm 1\%$	1.2 V, $\pm 1\%$
Output currents (I_{OUT})	1.0 A (max), 10 mA (min)	1.0 A (max), 5 mA (min)
RMS noise	< 5 μV_{RMS} , bandwidth = 10 Hz to 100 kHz	4.7 μV_{RMS} , bandwidth = 10 Hz to 100 kHz
PSRR at 750 kHz	> 40 dB	49 dB
Startup time	< 2 ms	800 μs (typ) 1.48 μs (max)

8.2.2 Detailed Design Procedure

The output voltage can be set to 1.2 V by selecting the correct values for R_1 and R_2 ; see [Equation 3](#).

Input and output capacitors are selected in accordance with the [Capacitor Recommendation](#) section. Ceramic capacitances of 10 μF for both input and output are selected to help balance the charge needed during startup when charging the output capacitor, thus reducing the input voltage drop.

To satisfy the required startup time (t_{SS}) and still maintain low-noise performance, a 0.1- μF $C_{NR/SS}$ is selected for with SS_CTRL connected to V_{IN} . This value is calculated with [Equation 9](#). Using the $I_{NR/SS(MAX)}$ and the smallest $C_{NR/SS}$ capacitance resulting from manufacturing variance (often $\pm 20\%$) provides the fastest startup time, whereas using the $I_{NR/SS(MIN)}$ and the largest $C_{NR/SS}$ capacitance resulting from manufacturing variance provides the slowest startup time.

$$t_{SS} = (V_{REF} \times C_{NR/SS}) / I_{NR/SS} \quad (9)$$

With a 1.0-A maximum load, the internal power dissipation is 800 mW, corresponding to a 46°C junction temperature rise. With an 55°C maximum ambient temperature, the junction temperature is at 101°C. To minimize noise, a feed-forward capacitance (C_{FF}) of 10 nF is selected.

See the [Layout](#) section for an example of how to layout the TPS7A91 to achieve best PSRR and noise.

8.2.3 Application Curves

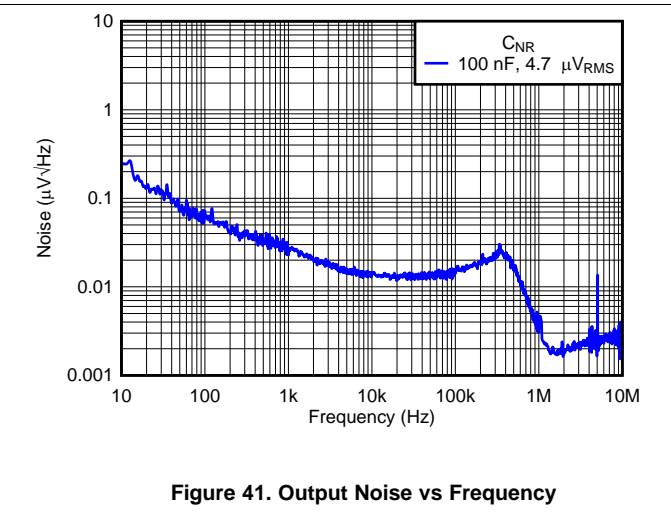
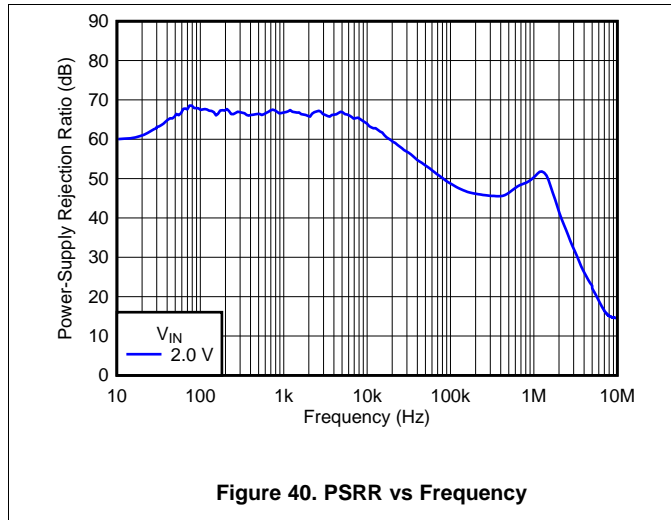

9 Power Supply Recommendations

The input of the TPS7A91 is designed to operate from an input voltage range between 1.4 V and 6.5 V and with an input capacitor of 10 µF. The input voltage range must provide adequate headroom in order for the device to have a regulated output. This input supply must be well regulated. If the input supply is noisy, additional input capacitors can be used to improve the output noise performance.

10 Layout

10.1 Layout Guidelines

General guidelines for linear regulator designs are to place all circuit components on the same side of the circuit board and as near as practical to the respective LDO pin connections. Place ground return connections to the input and output capacitors, and to the LDO ground pin as close to each other as possible, connected by a wide, component-side, copper surface. The use of vias and long traces to create LDO circuit connections is strongly discouraged and negatively affects system performance.

10.1.1 Board Layout

To maximize the ac performance of the TPS7A91, following the layout example illustrated in [Figure 42](#) is recommended. This layout isolates the analog ground (AGND) from the noisy power ground. Components that must be connected to the quiet analog ground are the noise reduction capacitor ($C_{NR/SS}$) and the lower feedback resistor (R_2). These components must have a separate connection back to the power pad of the device for optimal output noise performance. Connect the GND pin directly to the thermal pad and not to any external plane.

To maximize the output voltage accuracy, the connection from the output voltage back to top output divider resistors (R_1) must be made as close as possible to the load. This method of connecting the feedback trace eliminates the voltage drop from the device output to the load.

To improve thermal performance, use an array of thermal vias to connect the thermal pad to the ground planes. Larger ground planes improve the thermal performance of the device and lowering the operating temperature of the device.

10.2 Layout Example

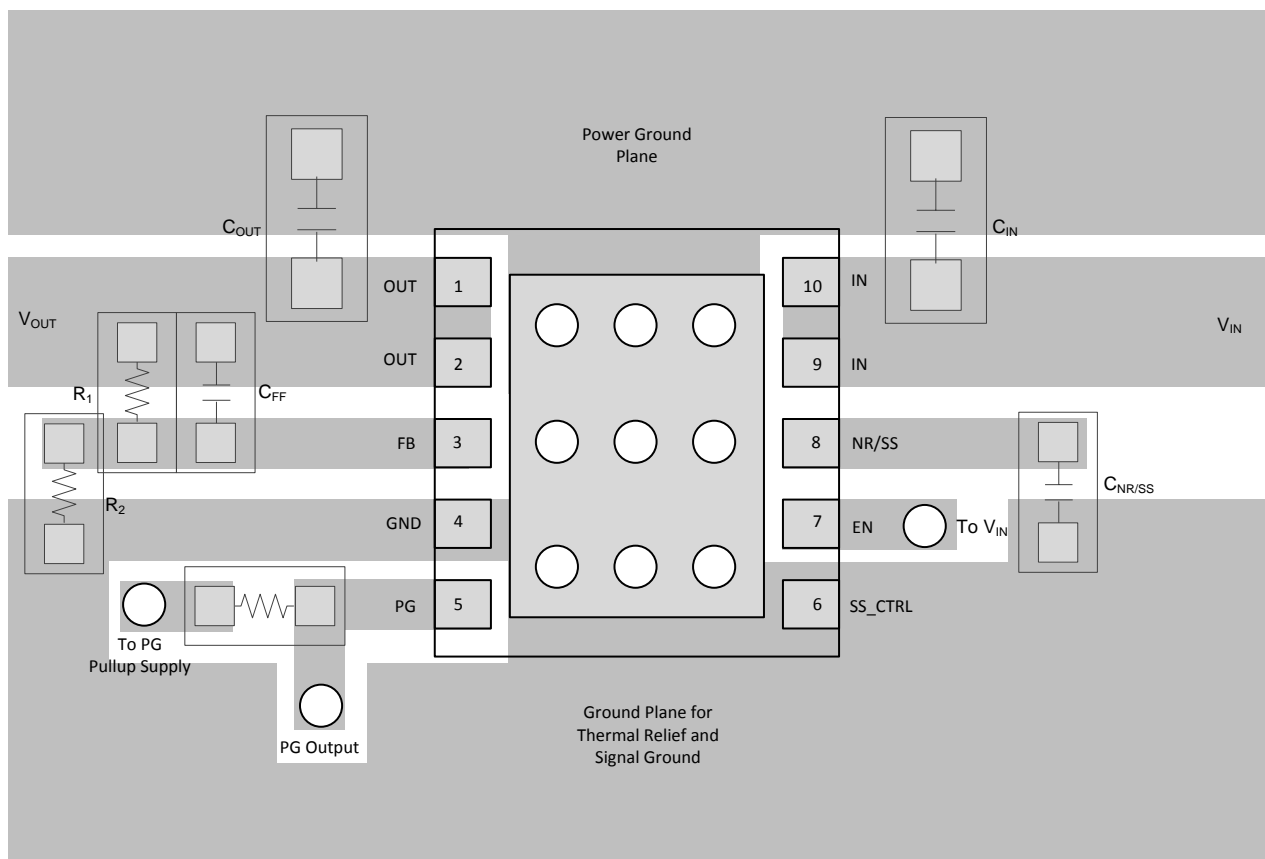

○ Denotes vias used for application purposes

Figure 42. TPS7A91 Example Layout

11 Device and Documentation Support

11.1 Device Support

11.1.1 Development Support

11.1.1.1 Evaluation Modules

An evaluation module (EVM) is available to assist in the initial circuit performance evaluation using the TPS7A91. The summary information for this fixture is shown in [Table 4](#).

Table 4. Design Kits and Evaluation Modules⁽¹⁾

NAME	PART NUMBER
TPS7A91 Low-Dropout Voltage Regulator Evaluation Module	TPS7A91EVM-831

(1) For the most current package and ordering information see the Package Option Addendum at the end of this document, or see the device product folder at www.ti.com.

The EVM can be requested at the [Texas Instruments web site](#) through the TPS7A91 product folder.

11.1.1.2 SPICE Models

Computer simulation of circuit performance using SPICE is often useful when analyzing the performance of analog circuits and systems. A SPICE model for the TPS7A91 is available through the TPS7A91 product folder under simulation models.

11.1.2 Device Nomenclature

Table 5. Ordering Information⁽¹⁾

PRODUCT	DESCRIPTION
TPS7A91XXYYZ	XX represents the output voltage. 01 is the adjustable output version. YYY is the package designator. Z is the package quantity.

(1) For the most current package and ordering information see the Package Option Addendum at the end of this document, or see the device product folder at www.ti.com.

11.2 Documentation Support

11.2.1 Related Documentation

[TPS3890 Low Quiescent Current, 1% Accurate Supervisor with Programmable Delay](#) (SLVSD65)

[TPS7A91EVM User's Guide](#) (SBVU036)

[Pros and Cons of Using a Feedforward Capacitor with a Low-Dropout Regulator](#) (SBVA042)

[How to Measure LDO Noise](#) (SLYY076)

[Semiconductor and IC Package Thermal Metrics](#) (SPRA953)

11.3 Receiving Notification of Documentation Updates

To receive notification of documentation updates, navigate to the device product folder on ti.com. In the upper right corner, click on *Alert me* to register and receive a weekly digest of any product information that has changed. For change details, review the revision history included in any revised document.

11.4 Community Resources

The following links connect to TI community resources. Linked contents are provided "AS IS" by the respective contributors. They do not constitute TI specifications and do not necessarily reflect TI's views; see TI's [Terms of Use](#).

TI E2E™ Online Community *TI's Engineer-to-Engineer (E2E) Community*. Created to foster collaboration among engineers. At e2e.ti.com, you can ask questions, share knowledge, explore ideas and help solve problems with fellow engineers.

Design Support *TI's Design Support* Quickly find helpful E2E forums along with design support tools and contact information for technical support.

11.5 Trademarks

E2E is a trademark of Texas Instruments.
All other trademarks are the property of their respective owners.

11.6 Electrostatic Discharge Caution



This integrated circuit can be damaged by ESD. Texas Instruments recommends that all integrated circuits be handled with appropriate precautions. Failure to observe proper handling and installation procedures can cause damage.

ESD damage can range from subtle performance degradation to complete device failure. Precision integrated circuits may be more susceptible to damage because very small parametric changes could cause the device not to meet its published specifications.

11.7 Glossary



[SLYZ022](#) — *TI Glossary*.

This glossary lists and explains terms, acronyms, and definitions.

12 Mechanical, Packaging, and Orderable Information

The following pages include mechanical, packaging, and orderable information. This information is the most current data available for the designated devices. This data is subject to change without notice and revision of this document. For browser-based versions of this data sheet, refer to the left-hand navigation.

PACKAGING INFORMATION

Orderable Device	Status (1)	Package Type	Package Drawing	Pins	Package Qty	Eco Plan (2)	Lead/Ball Finish (6)	MSL Peak Temp (3)	Op Temp (°C)	Device Marking (4/5)	Samples
TPS7A9101DSKR	ACTIVE	SON	DSK	10	3000	Green (RoHS & no Sb/Br)	NIPDAU	Level-2-260C-1 YEAR	-40 to 125	19GP	
TPS7A9101DSKT	ACTIVE	SON	DSK	10	250	Green (RoHS & no Sb/Br)	NIPDAU	Level-2-260C-1 YEAR	-40 to 125	19GP	

(1) The marketing status values are defined as follows:

ACTIVE: Product device recommended for new designs.

LIFEBUY: TI has announced that the device will be discontinued, and a lifetime-buy period is in effect.

NRND: Not recommended for new designs. Device is in production to support existing customers, but TI does not recommend using this part in a new design.

PREVIEW: Device has been announced but is not in production. Samples may or may not be available.

OBsolete: TI has discontinued the production of the device.

(2) **RoHS:** TI defines "RoHS" to mean semiconductor products that are compliant with the current EU RoHS requirements for all 10 RoHS substances, including the requirement that RoHS substance do not exceed 0.1% by weight in homogeneous materials. Where designed to be soldered at high temperatures, "RoHS" products are suitable for use in specified lead-free processes. TI may reference these types of products as "Pb-Free".

RoHS Exempt: TI defines "RoHS Exempt" to mean products that contain lead but are compliant with EU RoHS pursuant to a specific EU RoHS exemption.

Green: TI defines "Green" to mean the content of Chlorine (Cl) and Bromine (Br) based flame retardants meet JS709B low halogen requirements of <=1000ppm threshold. Antimony trioxide based flame retardants must also meet the <=1000ppm threshold requirement.

(3) MSL, Peak Temp. - The Moisture Sensitivity Level rating according to the JEDEC industry standard classifications, and peak solder temperature.

(4) There may be additional marking, which relates to the logo, the lot trace code information, or the environmental category on the device.

(5) Multiple Device Markings will be inside parentheses. Only one Device Marking contained in parentheses and separated by a "~" will appear on a device. If a line is indented then it is a continuation of the previous line and the two combined represent the entire Device Marking for that device.

(6) Lead/Ball Finish - Orderable Devices may have multiple material finish options. Finish options are separated by a vertical ruled line. Lead/Ball Finish values may wrap to two lines if the finish value exceeds the maximum column width.

Important Information and Disclaimer:The information provided on this page represents TI's knowledge and belief as of the date that it is provided. TI bases its knowledge and belief on information provided by third parties, and makes no representation or warranty as to the accuracy of such information. Efforts are underway to better integrate information from third parties. TI has taken and continues to take reasonable steps to provide representative and accurate information but may not have conducted destructive testing or chemical analysis on incoming materials and chemicals. TI and TI suppliers consider certain information to be proprietary, and thus CAS numbers and other limited information may not be available for release.

In no event shall TI's liability arising out of such information exceed the total purchase price of the TI part(s) at issue in this document sold by TI to Customer on an annual basis.

TAPE AND REEL INFORMATION



QUADRANT ASSIGNMENTS FOR PIN 1 ORIENTATION IN TAPE



*All dimensions are nominal

Device	Package Type	Package Drawing	Pins	SPQ	Reel Diameter (mm)	Reel Width W1 (mm)	A0 (mm)	B0 (mm)	K0 (mm)	P1 (mm)	W (mm)	Pin1 Quadrant
TPS7A9101DSKR	SON	DSK	10	3000	178.0	8.4	2.75	2.75	0.95	4.0	8.0	Q2
TPS7A9101DSKT	SON	DSK	10	250	178.0	8.4	2.75	2.75	0.95	4.0	8.0	Q2

TAPE AND REEL BOX DIMENSIONS

*All dimensions are nominal

Device	Package Type	Package Drawing	Pins	SPQ	Length (mm)	Width (mm)	Height (mm)
TPS7A9101DSKR	SON	DSK	10	3000	205.0	200.0	33.0
TPS7A9101DSKT	SON	DSK	10	250	205.0	200.0	33.0

GENERIC PACKAGE VIEW

DSK 10

WSON - 0.8 mm max height

2.5 x 2.5 mm, 0.5 mm pitch

PLASTIC SMALL OUTLINE - NO LEAD

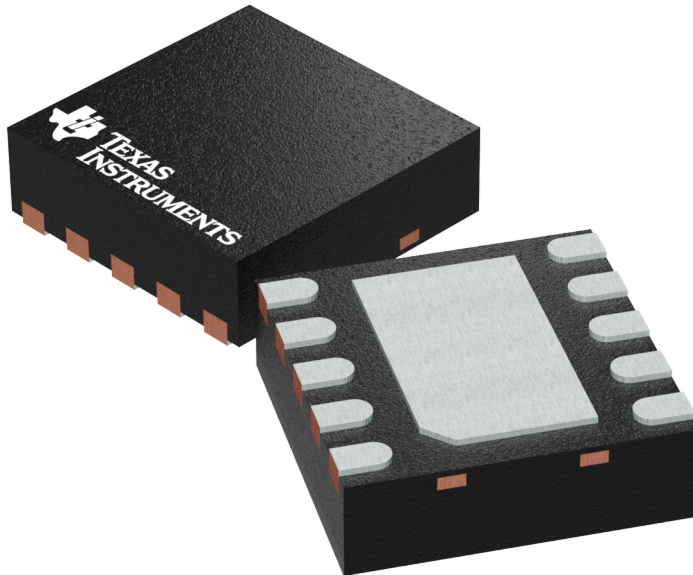

Images above are just a representation of the package family, actual package may vary.
Refer to the product data sheet for package details.

4225304/A

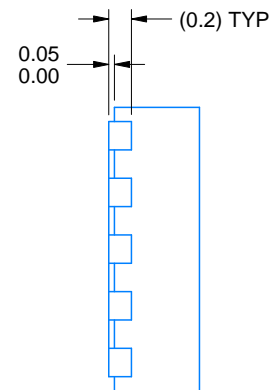
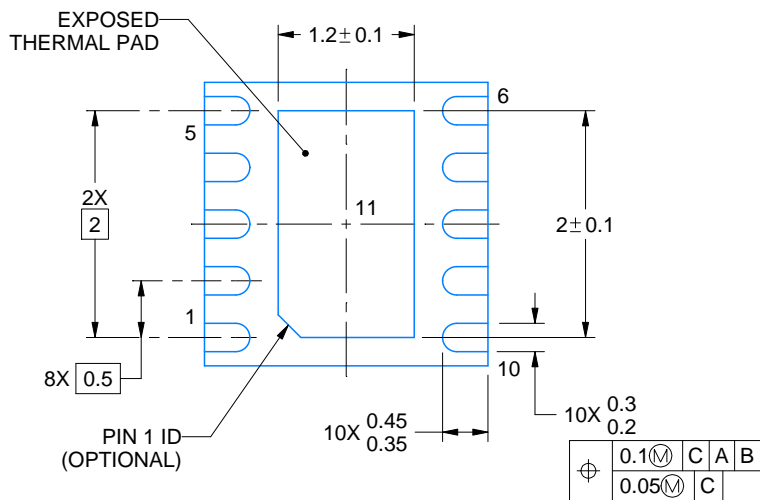
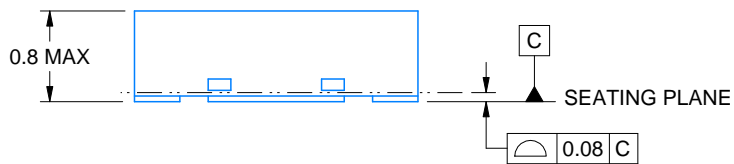
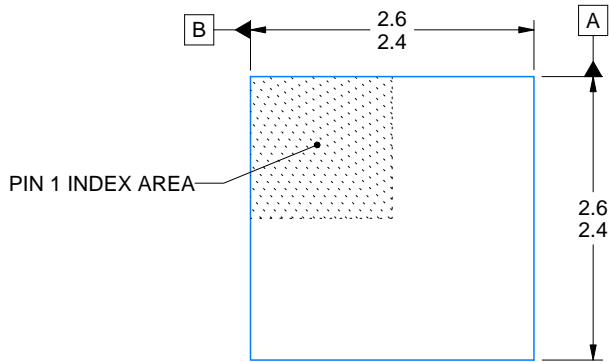
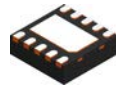

4218903/A 01/2018

NOTES:

1. All linear dimensions are in millimeters. Any dimensions in parenthesis are for reference only. Dimensioning and tolerancing per ASME Y14.5M.
2. This drawing is subject to change without notice.
3. The package thermal pad must be soldered to the printed circuit board for thermal and mechanical performance.

EXAMPLE BOARD LAYOUT

DSK0010A

WSON - 0.8 mm max height

PLASTIC SMALL OUTLINE - NO LEAD

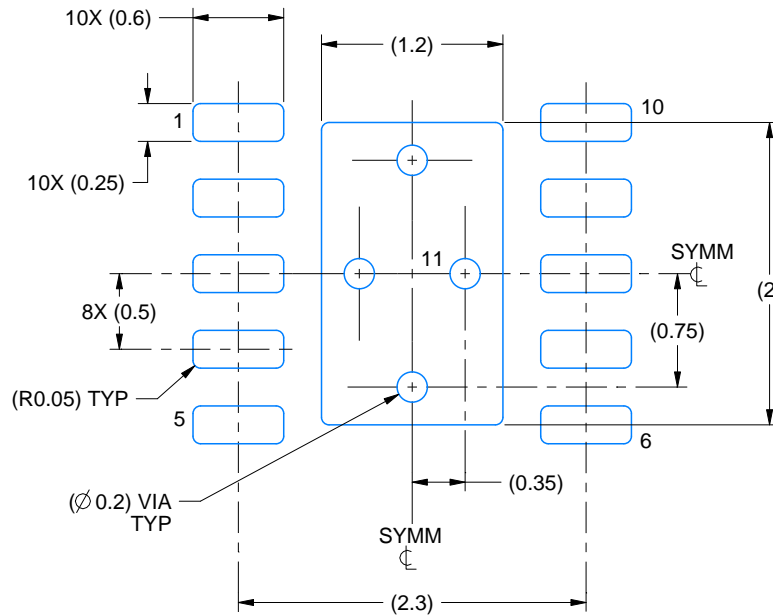

LAND PATTERN EXAMPLE
SCALE:20X

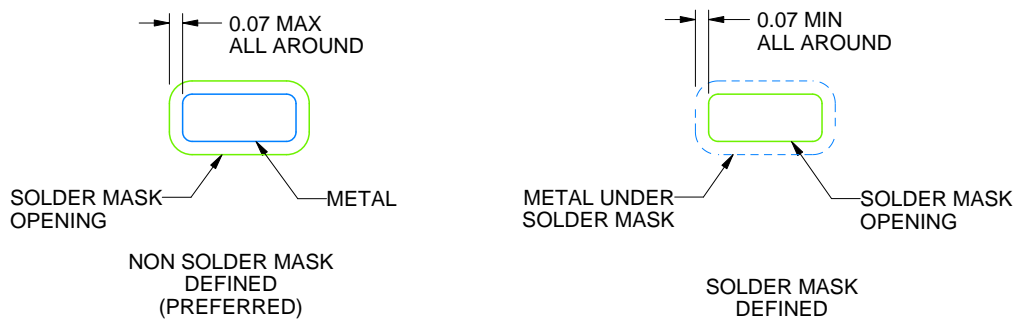

SOLDER MASK DETAILS

4218903/A 01/2018

NOTES: (continued)

4. This package is designed to be soldered to a thermal pad on the board. For more information, see Texas Instruments literature number SLUA271 (www.ti.com/lit/slue271).
5. Vias are optional depending on application, refer to device data sheet. If some or all are implemented, recommended via locations are shown.

EXAMPLE STENCIL DESIGN

DSK0010A

WSON - 0.8 mm max height

PLASTIC SMALL OUTLINE - NO LEAD

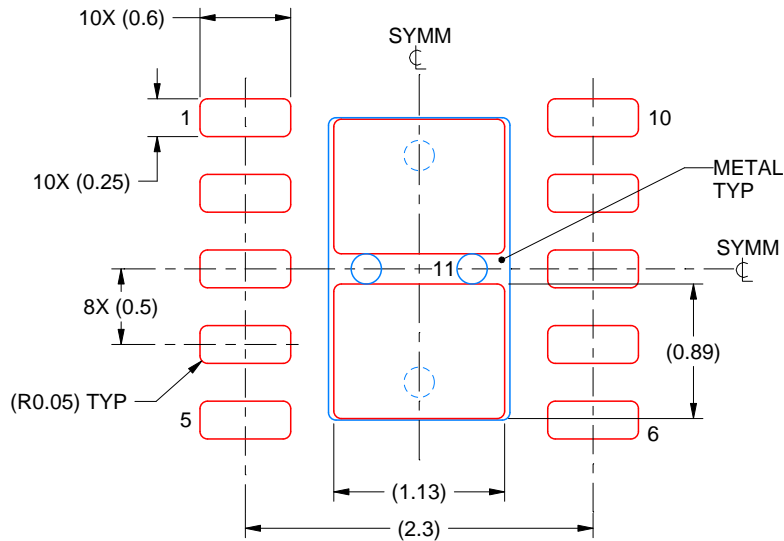

SOLDER PASTE EXAMPLE
BASED ON 0.125 mm THICK STENCIL

EXPOSED PAD 11
84% PRINTED SOLDER COVERAGE BY AREA
SCALE:20X

4218903/A 01/2018

NOTES: (continued)

6. Laser cutting apertures with trapezoidal walls and rounded corners may offer better paste release. IPC-7525 may have alternate design recommendations.

IMPORTANT NOTICE AND DISCLAIMER

TI PROVIDES TECHNICAL AND RELIABILITY DATA (INCLUDING DATASHEETS), DESIGN RESOURCES (INCLUDING REFERENCE DESIGNS), APPLICATION OR OTHER DESIGN ADVICE, WEB TOOLS, SAFETY INFORMATION, AND OTHER RESOURCES "AS IS" AND WITH ALL FAULTS, AND DISCLAIMS ALL WARRANTIES, EXPRESS AND IMPLIED, INCLUDING WITHOUT LIMITATION ANY IMPLIED WARRANTIES OF MERCHANTABILITY, FITNESS FOR A PARTICULAR PURPOSE OR NON-INFRINGEMENT OF THIRD PARTY INTELLECTUAL PROPERTY RIGHTS.

These resources are intended for skilled developers designing with TI products. You are solely responsible for (1) selecting the appropriate TI products for your application, (2) designing, validating and testing your application, and (3) ensuring your application meets applicable standards, and any other safety, security, or other requirements. These resources are subject to change without notice. TI grants you permission to use these resources only for development of an application that uses the TI products described in the resource. Other reproduction and display of these resources is prohibited. No license is granted to any other TI intellectual property right or to any third party intellectual property right. TI disclaims responsibility for, and you will fully indemnify TI and its representatives against, any claims, damages, costs, losses, and liabilities arising out of your use of these resources.

TI's products are provided subject to TI's Terms of Sale (www.ti.com/legal/termsofsale.html) or other applicable terms available either on ti.com or provided in conjunction with such TI products. TI's provision of these resources does not expand or otherwise alter TI's applicable warranties or warranty disclaimers for TI products.

Mailing Address: Texas Instruments, Post Office Box 655303, Dallas, Texas 75265
Copyright © 2020, Texas Instruments Incorporated