

### Features

- Buffered Inputs
- Typical Propagation Delay: 7ns at  $V_{CC} = 5V$ ,  $C_L = 15pF$ ,  $T_A = 25^\circ C$
- Fanout (Over Temperature Range)
  - Standard Outputs . . . . . 10 LSTTL Loads
  - Bus Driver Outputs . . . . . 15 LSTTL Loads
- Wide Operating Temperature Range . . .  $-55^\circ C$  to  $125^\circ C$
- Balanced Propagation Delay and Transition Times
- Significant Power Reduction Compared to LSTTL Logic ICs
- HC Types
  - 2V to 6V Operation
  - High Noise Immunity:  $N_{IL} = 30\%$ ,  $N_{IH} = 30\%$  of  $V_{CC}$  at  $V_{CC} = 5V$
- HCT Types
  - 4.5V to 5.5V Operation
  - Direct LSTTL Input Logic Compatibility,  $V_{IL} = 0.8V$  (Max),  $V_{IH} = 2V$  (Min)
- CMOS Input Compatibility,  $I_I \leq 1\mu A$  at  $V_{OL}$ ,  $V_{OH}$

### Description

The CD54HC08, CD54HCT08, CD74HC08, and CD74HCT08 logic gates utilize silicon gate CMOS technology to achieve operating speeds similar to LSTTL gates with the low power consumption of standard CMOS integrated circuits. All devices have the ability to drive 10 LSTTL loads. The 74HCT logic family is functionally pin compatible with the standard 74LS logic family.

### Ordering Information

PART NUMBER	TEMP. RANGE ( $^\circ C$ )	PACKAGE
CD54HC08F3A	-55 to 125	14 Ld CERDIP
CD54HCT08F3A	-55 to 125	14 Ld CERDIP
CD74HC08E	-55 to 125	14 Ld PDIP
CD74HC08M	-55 to 125	14 Ld SOIC
CD74HC08MT	-55 to 125	14 Ld SOIC
CD74HC08M96	-55 to 125	14 Ld SOIC
CD74HC08PW	-55 to 125	14 Ld TSSOP
CD74HC08PWR	-55 to 125	14 Ld TSSOP
CD74HCT08E	-55 to 125	14 Ld PDIP
CD74HCT08M	-55 to 125	14 Ld SOIC
CD74HCT08MT	-55 to 125	14 Ld SOIC
CD74HCT08M96	-55 to 125	14 Ld SOIC

NOTE: When ordering, use the entire part number. The suffix 96 denotes tape and reel. The suffix T denotes a small-quantity reel of 250.

# CD54HC08, CD74HC08, CD54HCT08, CD74HCT08

## Pinout

CD54HC08, CD54HCT08,  
(CERDIP)  
CD74HC08  
(PDIP, SOIC, TSSOP)  
CD74HCT08  
(PDIP, SOIC)  
TOP VIEW

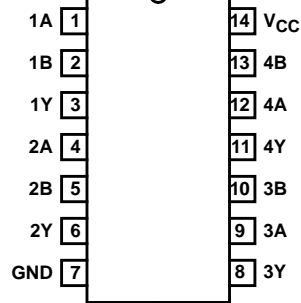

## Functional Diagram

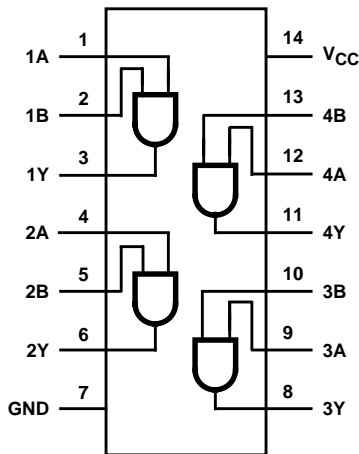

TRUTH TABLE

INPUTS		OUTPUT
nA	nB	nY
L	L	L
L	H	L
H	L	L
H	H	H

H = High Voltage Level, L = Low Voltage Level

**HC Logic Symbol**

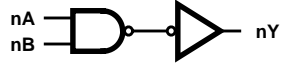

**HCT Logic Symbol**

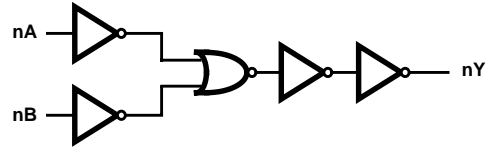

## CD54HC08, CD74HC08, CD54HCT08, CD74HCT08

### Absolute Maximum Ratings

DC Supply Voltage, $V_{CC}$ .....	-0.5V to 7V
DC Input Diode Current, $I_{IK}$	
For $V_I < -0.5V$ or $V_I > V_{CC} + 0.5V$ .....	$\pm 20mA$
DC Output Diode Current, $I_{OK}$	
For $V_O < -0.5V$ or $V_O > V_{CC} + 0.5V$ .....	$\pm 20mA$
DC Output Source or Sink Current per Output Pin, $I_O$	
For $V_O > -0.5V$ or $V_O < V_{CC} + 0.5V$ .....	$\pm 25mA$
DC $V_{CC}$ or Ground Current, $I_{CC}$ or $I_{GND}$ .....	$\pm 50mA$

### Thermal Information

Thermal Resistance (Typical, Note 1)	$\theta_{JA}$ ( $^{\circ}C/W$ )
E (PDIP) Package .....	80
M (SOIC) Package .....	86
PW (TSSOP) Package .....	113
Maximum Junction Temperature (Hermetic Package or Die) ..	$175^{\circ}C$
Maximum Junction Temperature (Plastic Package) .....	$150^{\circ}C$
Maximum Storage Temperature Range .....	$-65^{\circ}C$ to $150^{\circ}C$
Maximum Lead Temperature (Soldering 10s) .....	$300^{\circ}C$
(SOIC - Lead Tips Only)	

### Operating Conditions

Temperature Range ( $T_A$ ) .....	$-55^{\circ}C$ to $125^{\circ}C$
Supply Voltage Range, $V_{CC}$	
HC Types .....	.2V to 6V
HCT Types .....	4.5V to 5.5V
DC Input or Output Voltage, $V_I$ , $V_O$ .....	0V to $V_{CC}$
Input Rise and Fall Time	
2V .....	1000ns (Max)
4.5V .....	500ns (Max)
6V .....	400ns (Max)

*CAUTION: Stresses above those listed in "Absolute Maximum Ratings" may cause permanent damage to the device. This is a stress only rating and operation of the device at these or any other conditions above those indicated in the operational sections of this specification is not implied.*

#### NOTE:

1. The package thermal impedance is calculated in accordance with JESD 51-7.

### DC Electrical Specifications

PARAMETER	SYMBOL	TEST CONDITIONS		$V_{CC}$ (V)	25 $^{\circ}C$			-40 $^{\circ}C$ TO 85 $^{\circ}C$		-55 $^{\circ}C$ TO 125 $^{\circ}C$		UNITS
		$V_I$ (V)	$I_O$ (mA)		MIN	TYP	MAX	MIN	MAX	MIN	MAX	
<b>HC TYPES</b>												
High Level Input Voltage	$V_{IH}$	-	-	2	1.5	-	-	1.5	-	1.5	-	V
				4.5	3.15	-	-	3.15	-	3.15	-	V
				6	4.2	-	-	4.2	-	4.2	-	V
Low Level Input Voltage	$V_{IL}$	-	-	2	-	-	0.5	-	0.5	-	0.5	V
				4.5	-	-	1.35	-	1.35	-	1.35	V
				6	-	-	1.8	-	1.8	-	1.8	V
High Level Output Voltage CMOS Loads	$V_{OH}$	$V_{IH}$ or $V_{IL}$	-0.02	2	1.9	-	-	1.9	-	1.9	-	V
			-0.02	4.5	4.4	-	-	4.4	-	4.4	-	V
			-0.02	6	5.9	-	-	5.9	-	5.9	-	V
High Level Output Voltage TTL Loads	$V_{OH}$	$V_{IH}$ or $V_{IL}$	-	-	-	-	-	-	-	-	-	V
			-4	4.5	3.98	-	-	3.84	-	3.7	-	V
			-5.2	6	5.48	-	-	5.34	-	5.2	-	V
Low Level Output Voltage CMOS Loads	$V_{OL}$	$V_{IH}$ or $V_{IL}$	0.02	2	-	-	0.1	-	0.1	-	0.1	V
			0.02	4.5	-	-	0.1	-	0.1	-	0.1	V
			0.02	6	-	-	0.1	-	0.1	-	0.1	V
Low Level Output Voltage TTL Loads	$V_{OL}$	$V_{IH}$ or $V_{IL}$	-	-	-	-	-	-	-	-	-	V
			4	4.5	-	-	0.26	-	0.33	-	0.4	V
			5.2	6	-	-	0.26	-	0.33	-	0.4	V
Input Leakage Current	$I_I$	$V_{CC}$ or GND	-	6	-	-	$\pm 0.1$	-	$\pm 1$	-	$\pm 1$	$\mu A$

**CD54HC08, CD74HC08, CD54HCT08, CD74HCT08**

**DC Electrical Specifications (Continued)**

PARAMETER	SYMBOL	TEST CONDITIONS		V <sub>CC</sub> (V)	25°C			-40°C TO 85°C		-55°C TO 125°C		UNITS
		V <sub>I</sub> (V)	I <sub>O</sub> (mA)		MIN	TYP	MAX	MIN	MAX	MIN	MAX	
Quiescent Device Current	I <sub>CC</sub>	V <sub>CC</sub> or GND	0	6	-	-	2	-	20	-	40	μA
<b>HCT TYPES</b>												
High Level Input Voltage	V <sub>IH</sub>	-	-	4.5 to 5.5	2	-	-	2	-	2	-	V
Low Level Input Voltage	V <sub>IL</sub>	-	-	4.5 to 5.5	-	-	0.8	-	0.8	-	0.8	V
High Level Output Voltage CMOS Loads	V <sub>OH</sub>	V <sub>IH</sub> or V <sub>IL</sub>	-0.02	4.5	4.4	-	-	4.4	-	4.4	-	V
High Level Output Voltage TTL Loads			-4	4.5	3.98	-	-	3.84	-	3.7	-	V
Low Level Output Voltage CMOS Loads	V <sub>OL</sub>	V <sub>IH</sub> or V <sub>IL</sub>	0.02	4.5	-	-	0.1	-	0.1	-	0.1	V
Low Level Output Voltage TTL Loads			4	4.5	-	-	0.26	-	0.33	-	0.4	V
Input Leakage Current	I <sub>I</sub>	V <sub>CC</sub> and GND	0	5.5	-	-	±0.1	-	±1	-	±1	μA
Quiescent Device Current	I <sub>CC</sub>	V <sub>CC</sub> or GND	0	5.5	-	-	2	-	20	-	40	μA
Additional Quiescent Device Current Per Input Pin: 1 Unit Load	ΔI <sub>CC</sub> (Note 2)	V <sub>CC</sub> - 2.1	-	4.5 to 5.5	-	100	360	-	450	-	490	μA

NOTE:

2. For dual-supply systems theoretical worst case (V<sub>I</sub> = 2.4V, V<sub>CC</sub> = 5.5V) specification is 1.8mA.

**HCT Input Loading Table**

INPUT	UNIT LOADS
All	0.6

NOTE: Unit Load is ΔI<sub>CC</sub> limit specified in DC Electrical Specifications table, e.g. 360μA max at 25°C.

**Switching Specifications** Input t<sub>r</sub>, t<sub>f</sub> = 6ns

PARAMETER	SYMBOL	TEST CONDITIONS	V <sub>CC</sub> (V)	25°C			-40°C TO 85°C		-55°C TO 125°C		UNITS
				MIN	TYP	MAX	MIN	MAX	MIN	MAX	
<b>HC TYPES</b>											
Propagation Delay, Input to Output (Figure 1)	t <sub>PLH</sub> , t <sub>PHL</sub>	C <sub>L</sub> = 50pF	2	-	-	90	-	115	-	135	ns
			4.5	-	-	18	-	23	-	27	ns
			6	-	-	15	-	20	-	23	ns
Propagation Delay, Data Input to Output Y	t <sub>PLH</sub> , t <sub>PHL</sub>	C <sub>L</sub> = 15pF	5	-	7	-	-	-	-	ns	

**Switching Specifications** Input  $t_r, t_f = 6\text{ns}$  (Continued)

PARAMETER	SYMBOL	TEST CONDITIONS	$V_{CC}$ (V)	25°C			-40°C TO 85°C		-55°C TO 125°C		UNITS
				MIN	TYP	MAX	MIN	MAX	MIN	MAX	
Transition Times (Figure 1)	$t_{TLH}, t_{THL}$	$C_L = 50\text{pF}$	2	-	-	75	-	95	-	110	ns
			4.5	-	-	15	-	19	-	22	ns
			6	-	-	13	-	16	-	19	ns
Input Capacitance	$C_I$	-	-	-	10	-	10	-	10	pF	
Power Dissipation Capacitance (Notes 3, 4)	$C_{PD}$	-	5	-	37	-	-	-	-	pF	
<b>HCT TYPES</b>											
Propagation Delay, Input to Output Y (Figure 2)	$t_{PLH}, t_{PHL}$	$C_L = 50\text{pF}$	4.5	-	-	25	-	31	-	38	ns
Propagation Delay, Data Input to Output Y	$t_{PLH}, t_{PHL}$	$C_L = 15\text{pF}$	5	-	10	-	-	-	-	-	ns
Transition Times (Figure 2)	$t_{TLH}, t_{THL}$	$C_L = 50\text{pF}$	4.5	-	-	15	-	19	-	22	ns
Input Capacitance	$C_I$	$C_L = 50\text{pF}$	-	-	-	10	-	10	-	10	pF
Power Dissipation Capacitance (Notes 3, 4)	$C_{PD}$	-	5	-	51	-	-	-	-	-	pF

**NOTES:**

- $C_{PD}$  is used to determine the dynamic power consumption, per gate.
- $P_D = V_{CC}^2 f_i (C_{PD} + C_L)$  where  $f_i$  = input frequency,  $C_L$  = output load capacitance,  $V_{CC}$  = supply voltage.

**Test Circuits and Waveforms**

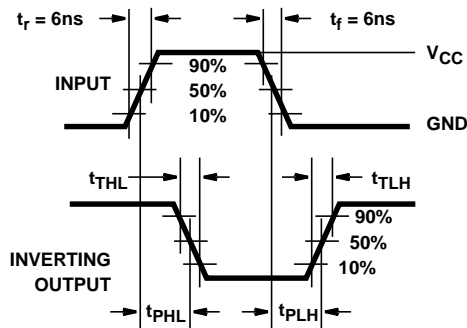

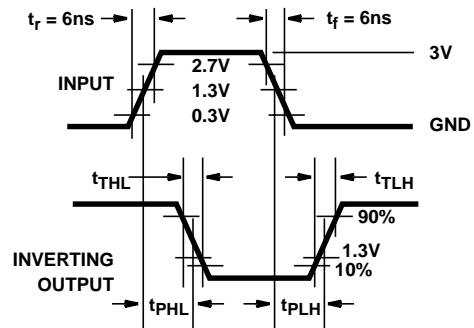

**FIGURE 3. HC AND HCU TRANSITION TIMES AND PROPAGATION DELAY TIMES, COMBINATION LOGIC**



**FIGURE 4. HCT TRANSITION TIMES AND PROPAGATION DELAY TIMES, COMBINATION LOGIC**

**PACKAGING INFORMATION**

Orderable Device	Status (1)	Package Type	Package Drawing	Pins	Package Qty	Eco Plan (2)	Lead/Ball Finish (6)	MSL Peak Temp (3)	Op Temp (°C)	Device Marking (4/5)	Samples
5962-8688301CA	ACTIVE	CDIP	J	14	1	TBD	Call TI	N / A for Pkg Type	-55 to 125	5962-8688301CA CD54HCT08F3A	<a href="#">Samples</a>
CD54HC08F	ACTIVE	CDIP	J	14	1	TBD	Call TI	N / A for Pkg Type	-55 to 125	CD54HC08F	<a href="#">Samples</a>
CD54HC08F3A	ACTIVE	CDIP	J	14	1	TBD	Call TI	N / A for Pkg Type	-55 to 125	8404701CA CD54HC08F3A	<a href="#">Samples</a>
CD54HCT08F	ACTIVE	CDIP	J	14	1	TBD	Call TI	N / A for Pkg Type	-55 to 125	CD54HCT08F	<a href="#">Samples</a>
CD54HCT08F3A	ACTIVE	CDIP	J	14	1	TBD	Call TI	N / A for Pkg Type	-55 to 125	5962-8688301CA CD54HCT08F3A	<a href="#">Samples</a>
CD74HC08E	ACTIVE	PDIP	N	14	25	Green (RoHS & no Sb/Br)	NIPDAU	N / A for Pkg Type	-55 to 125	CD74HC08E	<a href="#">Samples</a>
CD74HC08EE4	ACTIVE	PDIP	N	14	25	Green (RoHS & no Sb/Br)	NIPDAU	N / A for Pkg Type	-55 to 125	CD74HC08E	<a href="#">Samples</a>
CD74HC08M	ACTIVE	SOIC	D	14	50	Green (RoHS & no Sb/Br)	NIPDAU	Level-1-260C-UNLIM	-55 to 125	HC08M	<a href="#">Samples</a>
CD74HC08M96	ACTIVE	SOIC	D	14	2500	Green (RoHS & no Sb/Br)	NIPDAU	Level-1-260C-UNLIM	-55 to 125	HC08M	<a href="#">Samples</a>
CD74HC08M96E4	ACTIVE	SOIC	D	14	2500	Green (RoHS & no Sb/Br)	NIPDAU	Level-1-260C-UNLIM	-55 to 125	HC08M	<a href="#">Samples</a>
CD74HC08M96G4	ACTIVE	SOIC	D	14	2500	Green (RoHS & no Sb/Br)	NIPDAU	Level-1-260C-UNLIM	-55 to 125	HC08M	<a href="#">Samples</a>
CD74HC08ME4	ACTIVE	SOIC	D	14	50	Green (RoHS & no Sb/Br)	NIPDAU	Level-1-260C-UNLIM	-55 to 125	HC08M	<a href="#">Samples</a>
CD74HC08MT	ACTIVE	SOIC	D	14	250	Green (RoHS & no Sb/Br)	NIPDAU	Level-1-260C-UNLIM	-55 to 125	HC08M	<a href="#">Samples</a>
CD74HC08PW	ACTIVE	TSSOP	PW	14	90	Green (RoHS & no Sb/Br)	NIPDAU	Level-1-260C-UNLIM	-55 to 125	HJ08	<a href="#">Samples</a>
CD74HC08PWR	ACTIVE	TSSOP	PW	14	2000	Green (RoHS & no Sb/Br)	NIPDAU	Level-1-260C-UNLIM	-55 to 125	HJ08	<a href="#">Samples</a>
CD74HCT08E	ACTIVE	PDIP	N	14	25	Green (RoHS & no Sb/Br)	NIPDAU	N / A for Pkg Type	-55 to 125	CD74HCT08E	<a href="#">Samples</a>
CD74HCT08M	ACTIVE	SOIC	D	14	50	Green (RoHS & no Sb/Br)	NIPDAU	Level-1-260C-UNLIM	-55 to 125	HCT08M	<a href="#">Samples</a>

Orderable Device	Status (1)	Package Type	Package Drawing	Pins	Package Qty	Eco Plan (2)	Lead/Ball Finish (6)	MSL Peak Temp (3)	Op Temp (°C)	Device Marking (4/5)	Samples
CD74HCT08M96	ACTIVE	SOIC	D	14	2500	Green (RoHS & no Sb/Br)	NIPDAU	Level-1-260C-UNLIM	-55 to 125	HCT08M	
CD74HCT08ME4	ACTIVE	SOIC	D	14	50	Green (RoHS & no Sb/Br)	NIPDAU	Level-1-260C-UNLIM	-55 to 125	HCT08M	

(1) The marketing status values are defined as follows:

**ACTIVE:** Product device recommended for new designs.

**LIFEBUY:** TI has announced that the device will be discontinued, and a lifetime-buy period is in effect.

**NRND:** Not recommended for new designs. Device is in production to support existing customers, but TI does not recommend using this part in a new design.

**PREVIEW:** Device has been announced but is not in production. Samples may or may not be available.

**OBSOLETE:** TI has discontinued the production of the device.

(2) **RoHS:** TI defines "RoHS" to mean semiconductor products that are compliant with the current EU RoHS requirements for all 10 RoHS substances, including the requirement that RoHS substance do not exceed 0.1% by weight in homogeneous materials. Where designed to be soldered at high temperatures, "RoHS" products are suitable for use in specified lead-free processes. TI may reference these types of products as "Pb-Free".

**RoHS Exempt:** TI defines "RoHS Exempt" to mean products that contain lead but are compliant with EU RoHS pursuant to a specific EU RoHS exemption.

**Green:** TI defines "Green" to mean the content of Chlorine (Cl) and Bromine (Br) based flame retardants meet JS709B low halogen requirements of <=1000ppm threshold. Antimony trioxide based flame retardants must also meet the <=1000ppm threshold requirement.

(3) MSL, Peak Temp. - The Moisture Sensitivity Level rating according to the JEDEC industry standard classifications, and peak solder temperature.

(4) There may be additional marking, which relates to the logo, the lot trace code information, or the environmental category on the device.

(5) Multiple Device Markings will be inside parentheses. Only one Device Marking contained in parentheses and separated by a "~" will appear on a device. If a line is indented then it is a continuation of the previous line and the two combined represent the entire Device Marking for that device.

(6) Lead/Ball Finish - Orderable Devices may have multiple material finish options. Finish options are separated by a vertical ruled line. Lead/Ball Finish values may wrap to two lines if the finish value exceeds the maximum column width.

**Important Information and Disclaimer:**The information provided on this page represents TI's knowledge and belief as of the date that it is provided. TI bases its knowledge and belief on information provided by third parties, and makes no representation or warranty as to the accuracy of such information. Efforts are underway to better integrate information from third parties. TI has taken and continues to take reasonable steps to provide representative and accurate information but may not have conducted destructive testing or chemical analysis on incoming materials and chemicals. TI and TI suppliers consider certain information to be proprietary, and thus CAS numbers and other limited information may not be available for release.

In no event shall TI's liability arising out of such information exceed the total purchase price of the TI part(s) at issue in this document sold by TI to Customer on an annual basis.

**OTHER QUALIFIED VERSIONS OF CD54HC08, CD54HCT08, CD74HC08, CD74HCT08 :**



- Catalog: [CD74HC08](#), [CD74HCT08](#)
- Automotive: [CD74HC08-Q1](#), [CD74HC08-Q1](#)
- Enhanced Product: [CD74HC08-EP](#), [CD74HC08-EP](#)
- Military: [CD54HC08](#), [CD54HCT08](#)

NOTE: Qualified Version Definitions:

- Catalog - TI's standard catalog product
- Automotive - Q100 devices qualified for high-reliability automotive applications targeting zero defects
- Enhanced Product - Supports Defense, Aerospace and Medical Applications
- Military - QML certified for Military and Defense Applications

**TAPE AND REEL INFORMATION**

**QUADRANT ASSIGNMENTS FOR PIN 1 ORIENTATION IN TAPE**

\*All dimensions are nominal

Device	Package Type	Package Drawing	Pins	SPQ	Reel Diameter (mm)	Reel Width W1 (mm)	A0 (mm)	B0 (mm)	K0 (mm)	P1 (mm)	W (mm)	Pin1 Quadrant
CD74HC08M96	SOIC	D	14	2500	330.0	16.4	6.5	9.0	2.1	8.0	16.0	Q1
CD74HC08MT	SOIC	D	14	250	330.0	16.4	6.5	9.0	2.1	8.0	16.0	Q1
CD74HC08PWR	TSSOP	PW	14	2000	330.0	12.4	6.9	5.6	1.6	8.0	12.0	Q1
CD74HCT08M96	SOIC	D	14	2500	330.0	16.4	6.5	9.0	2.1	8.0	16.0	Q1

**TAPE AND REEL BOX DIMENSIONS**

\*All dimensions are nominal

Device	Package Type	Package Drawing	Pins	SPQ	Length (mm)	Width (mm)	Height (mm)
CD74HC08M96	SOIC	D	14	2500	367.0	367.0	38.0
CD74HC08MT	SOIC	D	14	250	210.0	185.0	35.0
CD74HC08PWR	TSSOP	PW	14	2000	367.0	367.0	35.0
CD74HCT08M96	SOIC	D	14	2500	367.0	367.0	38.0

J 14

**GENERIC PACKAGE VIEW**  
**CDIP - 5.08 mm max height**  
CERAMIC DUAL IN LINE PACKAGE



Images above are just a representation of the package family, actual package may vary.  
Refer to the product data sheet for package details.

4040083-5/G

J0014A



# PACKAGE OUTLINE

CDIP - 5.08 mm max height

CERAMIC DUAL IN LINE PACKAGE



4214771/A 05/2017

NOTES:

1. All controlling linear dimensions are in inches. Dimensions in brackets are in millimeters. Any dimension in brackets or parenthesis are for reference only. Dimensioning and tolerancing per ASME Y14.5M.
2. This drawing is subject to change without notice.
3. This package is hermetically sealed with a ceramic lid using glass frit.
4. Index point is provided on cap for terminal identification only and on press ceramic glass frit seal only.
5. Falls within MIL-STD-1835 and GDIP1-T14.

# EXAMPLE BOARD LAYOUT

J0014A

CDIP - 5.08 mm max height

CERAMIC DUAL IN LINE PACKAGE



LAND PATTERN EXAMPLE  
NON-SOLDER MASK DEFINED  
SCALE: 5X



4214771/A 05/2017



D (R-PDSO-G14)

PLASTIC SMALL OUTLINE



- NOTES:
- A. All linear dimensions are in millimeters.
  - B. This drawing is subject to change without notice.
  - C. Publication IPC-7351 is recommended for alternate designs.
  - D. Laser cutting apertures with trapezoidal walls and also rounding corners will offer better paste release. Customers should contact their board assembly site for stencil design recommendations. Refer to IPC-7525 for other stencil recommendations.
  - E. Customers should contact their board fabrication site for solder mask tolerances between and around signal pads.



PW (R-PDSO-G14)

PLASTIC SMALL OUTLINE



4040064-3/G 02/11

- NOTES:
- A. All linear dimensions are in millimeters. Dimensioning and tolerancing per ASME Y14.5M-1994.
  - B. This drawing is subject to change without notice.
  - C. Body length does not include mold flash, protrusions, or gate burrs. Mold flash, protrusions, or gate burrs shall not exceed 0,15 each side.
  - D. Body width does not include interlead flash. Interlead flash shall not exceed 0,25 each side.
  - E. Falls within JEDEC MO-153

PW (R-PDSO-G14)

PLASTIC SMALL OUTLINE



4211284-2/G 08/15

- NOTES:
- A. All linear dimensions are in millimeters.
  - B. This drawing is subject to change without notice.
  - C. Publication IPC-7351 is recommended for alternate designs.
  - D. Laser cutting apertures with trapezoidal walls and also rounding corners will offer better paste release. Customers should contact their board assembly site for stencil design recommendations. Refer to IPC-7525 for other stencil recommendations.
  - E. Customers should contact their board fabrication site for solder mask tolerances between and around signal pads.

N (R-PDIP-T\*\*)

PLASTIC DUAL-IN-LINE PACKAGE

16 PINS SHOWN



- NOTES:
- A. All linear dimensions are in inches (millimeters).
  - B. This drawing is subject to change without notice.
  - $\triangle C$  Falls within JEDEC MS-001, except 18 and 20 pin minimum body length (Dim A).
  - $\triangle D$  The 20 pin end lead shoulder width is a vendor option, either half or full width.

## IMPORTANT NOTICE AND DISCLAIMER

TI PROVIDES TECHNICAL AND RELIABILITY DATA (INCLUDING DATASHEETS), DESIGN RESOURCES (INCLUDING REFERENCE DESIGNS), APPLICATION OR OTHER DESIGN ADVICE, WEB TOOLS, SAFETY INFORMATION, AND OTHER RESOURCES "AS IS" AND WITH ALL FAULTS, AND DISCLAIMS ALL WARRANTIES, EXPRESS AND IMPLIED, INCLUDING WITHOUT LIMITATION ANY IMPLIED WARRANTIES OF MERCHANTABILITY, FITNESS FOR A PARTICULAR PURPOSE OR NON-INFRINGEMENT OF THIRD PARTY INTELLECTUAL PROPERTY RIGHTS.

These resources are intended for skilled developers designing with TI products. You are solely responsible for (1) selecting the appropriate TI products for your application, (2) designing, validating and testing your application, and (3) ensuring your application meets applicable standards, and any other safety, security, or other requirements. These resources are subject to change without notice. TI grants you permission to use these resources only for development of an application that uses the TI products described in the resource. Other reproduction and display of these resources is prohibited. No license is granted to any other TI intellectual property right or to any third party intellectual property right. TI disclaims responsibility for, and you will fully indemnify TI and its representatives against, any claims, damages, costs, losses, and liabilities arising out of your use of these resources.

TI's products are provided subject to TI's Terms of Sale ([www.ti.com/legal/termsofsale.html](http://www.ti.com/legal/termsofsale.html)) or other applicable terms available either on [ti.com](http://ti.com) or provided in conjunction with such TI products. TI's provision of these resources does not expand or otherwise alter TI's applicable warranties or warranty disclaimers for TI products.

Mailing Address: Texas Instruments, Post Office Box 655303, Dallas, Texas 75265  
Copyright © 2020, Texas Instruments Incorporated