



## 16-Bit, Quad Voltage Output Digital-to-Analog Converter

### FEATURES

- Low Glitch: 1nV-s (typ)
- Low Power: 18mW
- Unipolar or Bipolar Operation
- Settling Time: 12μs to 0.003%
- 16-Bit Linearity and Monotonicity: -40°C to +85°C
- Programmable Reset to Mid-Scale or Zero-Scale
- Data Readback
- Double-Buffered Data Inputs
- Internal Bandgap Voltage Reference
- Power-On Reset
- 3V to 5V Logic Interface

### APPLICATIONS

- Process Control
- Closed-Loop Servo Control
- Motor Control
- Data Acquisition Systems
- DAC-per-Pin Programmers

### DESCRIPTION

The DAC7664 is a 16-bit, quad voltage output digital-to-analog converter (DAC) with 16-bit monotonic performance over the specified temperature range. It accepts 16-bit parallel input data, has double-buffered DAC input logic (allowing simultaneous update of all DACs), and provides a readback mode of the internal input registers. Programmable asynchronous reset clears all registers to a mid-scale code of 8000h or to a zero-scale of 0000h. The DAC7664 can operate from a single +5V supply or from +5V and -5V supplies.

Low power and small size per DAC make the DAC7664 ideal for automatic test equipment, DAC-per-pin programmers, data acquisition systems, and closed-loop servo control. The DAC7664 is available in an LQFP-64 package and is specified for operation over the -40°C to +85°C temperature range.

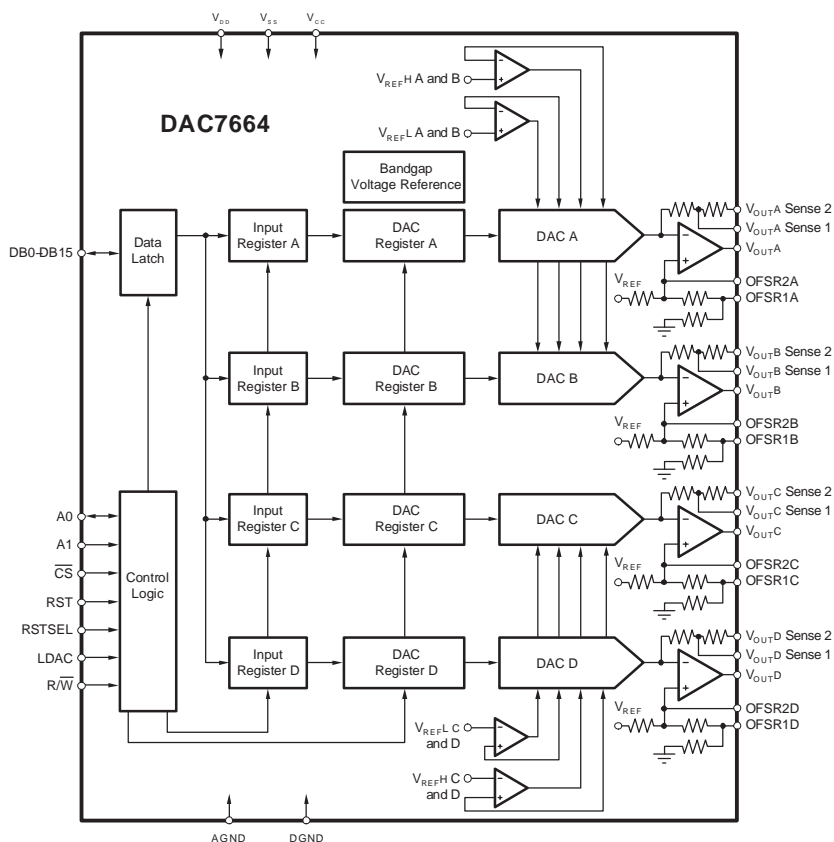

This device has ESD-CDM sensitivity and special handling precautions must be taken.



Please be aware that an important notice concerning availability, standard warranty, and use in critical applications of Texas Instruments semiconductor products and disclaimers thereto appears at the end of this data sheet.

All trademarks are the property of their respective owners.

**ORDERING INFORMATION(1)**

PRODUCT	PACKAGE-LEAD	PACKAGE DESIGNATOR	SPECIFIED TEMPERATURE RANGE	PACKAGE MARKING	ORDERING NUMBER	TRANSPORT MEDIA, QUANTITY
DAC7664Y	LQFP-64	PM	-40°C to +85°C	DAC7664Y	DAC7664YT	Tape and Reel, 250
					DAC7664YR	Tape and Reel, 1500
DAC7664YB	LQFP-64	PM	-40°C to +85°C	DAC7664YB	DAC7664YBT	Tape and Reel, 250
					DAC7664YBR	Tape and Reel, 1500
DAC7664YC	LQFP-64	PM	-40°C to +85°C	DAC7664YC	DAC7664YCT	Tape and Reel, 250
					DAC7664YCR	Tape and Reel, 1500

(1) For the most current package and ordering information, see the Package Option Addendum located at the end of this data sheet.

**ABSOLUTE MAXIMUM RATINGS**

over operating free-air temperature range unless otherwise noted(1)

	DAC7664	UNIT
IOV <sub>DD</sub> , V <sub>CC</sub> and V <sub>DD</sub> to V <sub>SS</sub>	-0.3 to 11	V
IOV <sub>DD</sub> , V <sub>CC</sub> and V <sub>DD</sub> to GND	-0.3 to 5.5	V
Digital Input Voltage to GND	-0.3 to V <sub>DD</sub> + 0.3	V
Digital Output Voltage to GND	-0.3 to V <sub>DD</sub> + 0.3	V
ESD-CDM	200	V
Maximum Junction Temperature	+150	°C
Operating Temperature Range	-40 to +85	°C
Storage Temperature Range	-65 to +125	°C
Lead Temperature (soldering, 10s)	+300	°C

(1) Stresses above those listed under Absolute Maximum Ratings may cause permanent damage to the device. Exposure to absolute maximum conditions for extended periods may degrade device reliability. These are stress ratings only, and functional operation of the device at these or any other conditions beyond those specified is not implied.



This integrated circuit can be damaged by ESD. Texas Instruments recommends that all integrated circuits be handled with appropriate precautions. Failure to observe

proper handling and installation procedures can cause damage.

ESD damage can range from subtle performance degradation to complete device failure. Precision integrated circuits may be more susceptible to damage because very small parametric changes could cause the device not to meet its published specifications.

**ELECTRICAL CHARACTERISTICS:  $V_{SS} = 0V$** 

 All specifications at  $T_A = T_{MIN}$  to  $T_{MAX}$ ,  $IOV_{DD} = V_{DD} = V_{CC} = +5V$ , and  $V_{SS} = 0V$ , unless otherwise noted.

PARAMETER	TEST CONDITIONS	DAC7664Y			DAC7664YB			DAC7664YC			UNIT
		MIN	TYP	MAX	MIN	TYP	MAX	MIN	TYP	MAX	
<b>Accuracy</b>											
Linearity error			±3	±4		±2	±3		*	*	LSB
Linearity match			±4			±2			*		LSB
Differential linearity error			±2	±3		±1	±2	-1		+2	LSB
Monotonicity, $T_{MIN}$ to $T_{MAX}$		14			15			16			Bit
Unipolar zero error			±1	±5		*	*		*	*	mV
Unipolar zero error drift			5	10		*	*		*	*	ppm/°C
Full-scale error			±6	±20		±4	±12.5		*	*	mV
Full-scale error drift			7	15		*	*		*	*	ppm/°C
Unipolar zero matching	Channel-to-channel matching		±3	±7		±2	±5		*	*	mV
Full-scale matching	Channel-to-channel matching		±4	±10		±2	±8		*	*	mV
Power-supply rejection ratio (PSRR)	At full-scale		10	100		*	*		*	*	ppm/V
<b>Analog Output</b>											
Voltage output	$R_L = 10k\Omega$	0		2.5	*		*	*		*	V
Output current		-1.25		+1.25	*		*	*		*	mA
Maximum load capacitance	No oscillation		500			*			*		pF
Short-circuit current			±20			*			*		mA
Short-circuit duration	GND or $V_{CC}$		Indefinite			*			*		
<b>Dynamic Performance</b>											
Settling time	To ±0.003%, 2.5V output step		12	15		*	*		*	*	μs
Channel-to-channel crosstalk			0.5			*			*		LSB
Digital feedthrough			2			*			*		nV-s
Output noise voltage	$f = 10kHz$		130			*			*		nV/√Hz
DAC glitch	7FFFh to 8000h or 8000h to 7FFFh		1	5		*	*		*	*	nV-s
<b>Digital Input</b>											
$V_{IH}$		$0.7 \times IOV_{DD}$				*			*		V
$V_{IL}$		$0.3 \times IOV_{DD}$					*		*		V
$I_{IH}$			±10				*		*		μA
$I_{IL}$			±10				*		*		μA
<b>Digital Output</b>											
$V_{OH}$	$I_{OH} = -0.8mA, IOV_{DD} = 5V$	3.6	4.5		*	*		*	*		V
$V_{OL}$	$I_{OL} = 1.6mA, IOV_{DD} = 5V$		0.3	0.4		*	*		*	*	V
$V_{OH}$	$I_{OH} = -0.4mA, IOV_{DD} = 3V$	2.4	2.6		*	*		*	*		V
$V_{OL}$	$I_{OL} = 0.8mA, IOV_{DD} = 3V$		0.3	0.4		*	*		*	*	V
<b>Power Supply</b>											
$V_{DD}$		+4.75	+5.0	+5.25	*	*	*	*	*	*	V
$IOV_{DD}$		+2.7	+5.0	+5.25	*	*	*	*	*	*	V
$V_{CC}$		+4.75	+5.0	+5.25	*	*	*	*	*	*	V
$V_{SS}$		0	0	0	*	*	*	*	*	*	V
$I_{CC}$			3.5	5		*	*		*	*	mA
$I_{DD}$			50			*			*		μA
$I(IOV_{DD})$			50			*			*		μA
Power			18	25		*	*		*		mW
<b>Temperature Range</b>											
Specified performance		-40		+85	*		*	*		*	°C

\* specifications same as the grade to the left

**ELECTRICAL CHARACTERISTICS:  $V_{SS} = -5V$**

All specifications at  $T_A = T_{MIN}$  to  $T_{MAX}$ ,  $IOV_{DD} = V_{DD} = V_{CC} = +5V$ , and  $V_{SS} = -5V$ , unless otherwise noted.

PARAMETER	TEST CONDITIONS	DAC7664Y			DAC7664YB			DAC7664YC			UNIT	
		MIN	TYP	MAX	MIN	TYP	MAX	MIN	TYP	MAX		
<b>Accuracy</b>												
Linearity error			±3	±4		±2	±3		*	*	LSB	
Linearity match			±4			±2			*		LSB	
Differential linearity error			±2	±3		±1	±2		-1		+2	LSB
Monotonicity, $T_{MIN}$ to $T_{MAX}$			14			15			16			Bit
Bipolar zero error			±1	±5		*	*		*	*		mV
Bipolar zero error drift			5	10		*	*		*	*		ppm/°C
Full-scale error			±6	±20		±4	±12.5		*	*		mV
Full-scale error drift			7	15		*	*		*	*		ppm/°C
Bipolar zero matching	Channel-to-channel matching		±3	±7		±2	±5		*	*		mV
Full-scale matching	Channel-to-channel matching		±4	±10		±2	±8		*	*		mV
Power-supply rejection ratio (PSRR)	At full-scale		10	100		*	*		*	*		ppm/V
<b>Analog Output</b>												
Voltage output	$R_L = 10k\Omega$		-2.5	+2.5		*	*		*	*		V
Output current			-1.25	+1.25		*	*		*	*		mA
Maximum load capacitance	No oscillation		500			*			*			pF
Short-circuit current			-15, +30			*			*			mA
Short-circuit duration	GND or $V_{CC}$ or $V_{SS}$		Indefinite			*			*			
<b>Dynamic Performance</b>												
Settling time	To ±0.003%, 5V output step		12	15		*	*		*	*		µs
Channel-to-channel crosstalk			0.5			*			*			LSB
Digital feedthrough			2			*			*			nV-s
Output noise voltage	$f = 10kHz$		200			*			*			nV/√Hz
DAC glitch	7FFFh to 8000h or 8000h to 7FFFh		2	7		*	*		*	*		nV-s
<b>Digital Input</b>												
$V_{IH}$			$0.7 \times IOV_{DD}$				*		*			V
$V_{IL}$			$0.3 \times IOV_{DD}$					*		*		V
$I_{IH}$			±10					*		*		µA
$I_{IL}$			±10					*		*		µA
<b>Digital Output</b>												
$V_{OH}$	$I_{OH} = -0.8mA, IOV_{DD} = 5V$		3.6	4.5		*	*		*	*		V
$V_{OL}$	$I_{OL} = 1.6mA, IOV_{DD} = 5V$			0.3	0.4		*	*		*	*	V
$V_{OH}$	$I_{OH} = -0.4mA, IOV_{DD} = 3V$		2.4	2.6		*	*		*	*		V
$V_{OL}$	$I_{OL} = 0.8mA, IOV_{DD} = 3V$			0.3	0.4		*	*		*	*	V
<b>Power Supply</b>												
$V_{DD}$			+4.75	+5.0	+5.25		*	*	*	*	*	V
$IOV_{DD}$			+2.7	+5.0	+5.25		*	*	*	*	*	V
$V_{CC}$			+4.75	+5.0	+5.25		*	*	*	*	*	V
$V_{SS}$			-5.25	-5.0	-4.75		*	*	*	*	*	V
$I_{CC}$				4	5.5			*	*		*	mA
$I_{DD}$				50				*		*		µA
$I(IOV_{DD})$				50				*		*		µA
$I_{SS}$			-3.5	-2.0			*	*		*	*	mA
Power				30	45			*	*		*	mW
<b>Temperature Range</b>												
Specified performance			-40		+85		*	*	*	*		°C

\* specifications same as the grade to the left

**PIN ASSIGNMENTS**

**LQFP PACKAGE  
(TOP VIEW)**

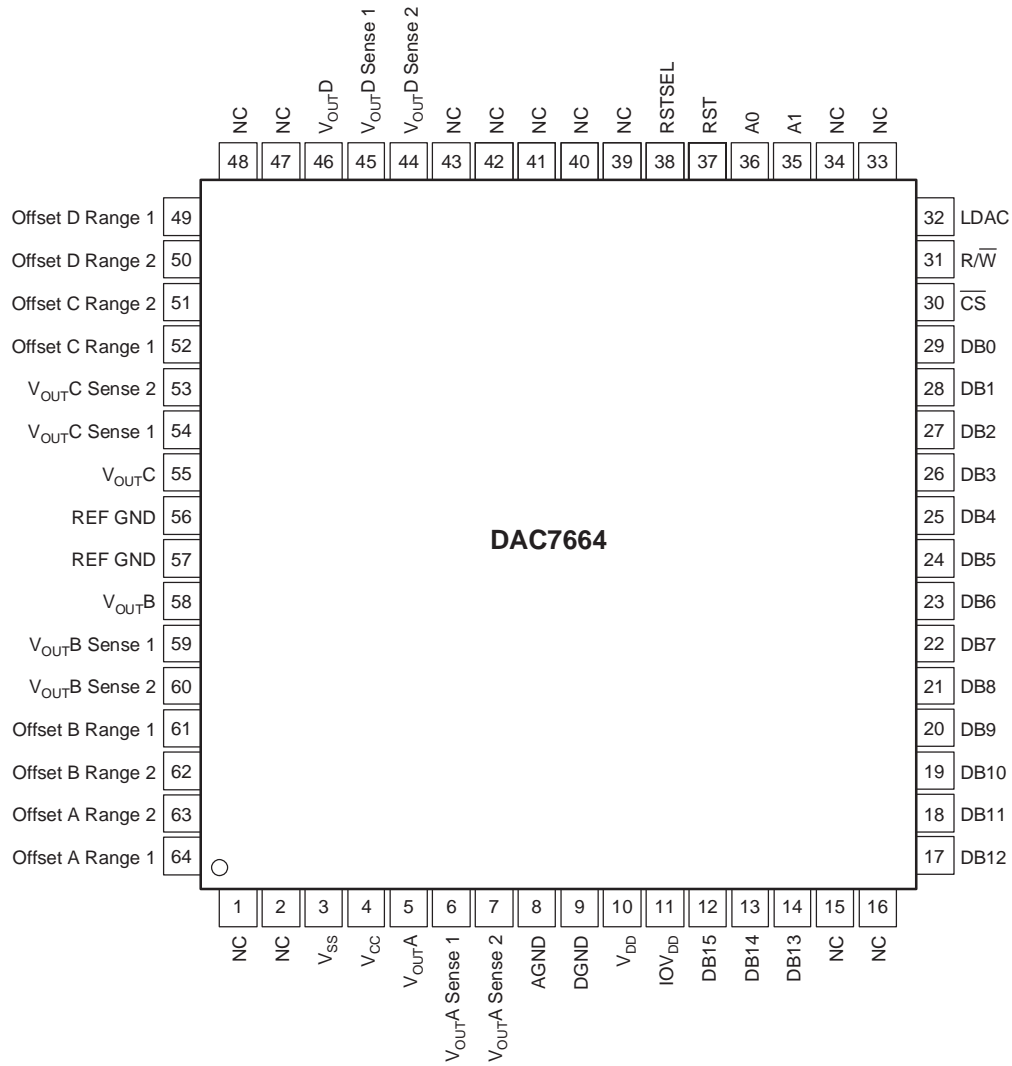

## Terminal Functions

PIN	NAME	DESCRIPTION
1	NC	No Connection
2	NC	No Connection
3	V <sub>SS</sub>	Analog –5V power supply or 0V single supply
4	V <sub>CC</sub>	Analog +5V power supply
5	V <sub>OUTA</sub>	DAC A output voltage
6	V <sub>OUTA</sub> Sense 1	Connect to V <sub>OUTA</sub> for unipolar mode
7	V <sub>OUTA</sub> Sense 2	Connect to V <sub>OUTA</sub> for bipolar mode
8	AGND	Analog ground
9	DGND	Digital ground
10	V <sub>DD</sub>	Digital +5V power supply
11	IOV <sub>DD</sub>	Interface power supply
12	DB15	Data bit 15 (MSB)
13	DB14	Data bit 14
14	DB13	Data bit 13
15	NC	No connection
16	NC	No connection
17	DB12	Data bit 12
18	DB11	Data bit 11
19	DB10	Data bit 10
20	DB9	Data bit 9
21	DB8	Data bit 8
22	DB7	Data bit 7
23	DB6	Data bit 6
24	DB5	Data bit 5
25	DB4	Data bit 4
26	DB3	Data bit 3
27	DB2	Data bit 2
28	DB1	Data bit 1
29	DB0	Data bit 0
30	CS	Chip select, active low
31	R/W	Enabled by CS; controls the data read and data write.
32	LDAC	DAC register load control, rising edge triggered.
33	NC	No connection
34	NC	No connection
35	A1	Enabled by CS; in combination with A0, selects the individual DAC input registers.
36	A0	Enabled by CS; in combination with A1, selects the individual DAC input registers.
37	RST	Reset, rising edge triggered. Depending on the state of RSTSEL, the DAC registers are set to either mid-scale or zero.

PIN	NAME	DESCRIPTION
38	RSTSEL	Reset select. Determines the action of RST. If high, an RST command sets the DAC registers to mid-scale (8000h). If low, an RST command sets the DAC registers to zero (0000h).
39	NC	No connection
40	NC	No connection
41	NC	No connection
42	NC	No connection
43	NC	No connection
44	V <sub>OUTD</sub> Sense 2	Connect to V <sub>OUTD</sub> for bipolar mode
45	V <sub>OUTD</sub> Sense 1	Connect to V <sub>OUTD</sub> for unipolar mode
46	V <sub>OUTD</sub>	DAC D output
47	NC	No connection
48	NC	No connection
49	Offset D Range 1	Connect to Offset D Range 2 for unipolar mode
50	Offset D Range 2	Connect to Offset D Range 1 for unipolar mode
51	Offset C Range 2	Connect to Offset C Range 1 for unipolar mode
52	Offset C Range 1	Connect to Offset C Range 2 for unipolar mode
53	V <sub>OUTC</sub> Sense 2	Connect to V <sub>OUTC</sub> for bipolar mode
54	V <sub>OUTC</sub> Sense 1	Connect to V <sub>OUTC</sub> for unipolar mode
55	V <sub>OUTC</sub>	DAC C output
56	REF GND	Reference ground
57	REF GND	Reference ground
58	V <sub>OUTB</sub>	DAC B output
59	V <sub>OUTB</sub> Sense 1	Connect to V <sub>OUTB</sub> for unipolar mode
60	V <sub>OUTB</sub> Sense 2	Connect to V <sub>OUTB</sub> for bipolar mode
61	Offset B Range 1	Connect to Offset B Range 2 for unipolar mode
62	Offset B Range 2	Connect to Offset B Range 1 for unipolar mode
63	Offset A Range 2	Connect to Offset A Range 1 for unipolar mode
64	Offset A Range 1	Connect to Offset A Range 2 for unipolar mode

**TYPICAL CHARACTERISTICS:  $V_{SS} = 0V$  (+25°C)**

All specifications at  $T_A = 25^\circ C$ ,  $IOV_{DD} = V_{DD} = V_{CC} = +5V$ ,  $V_{SS} = 0V$ , representative unit, unless otherwise noted.

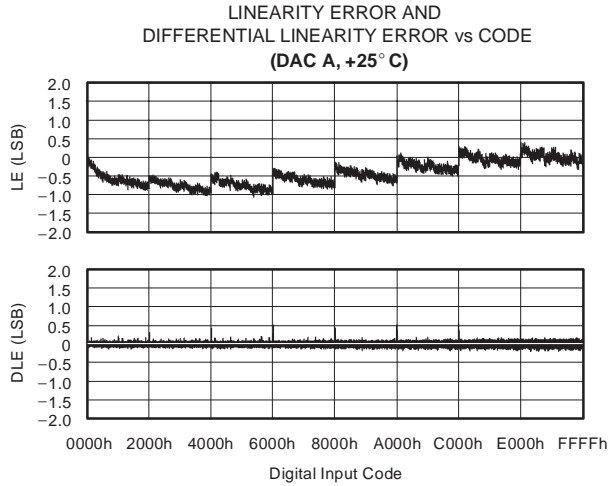

**Figure 1**

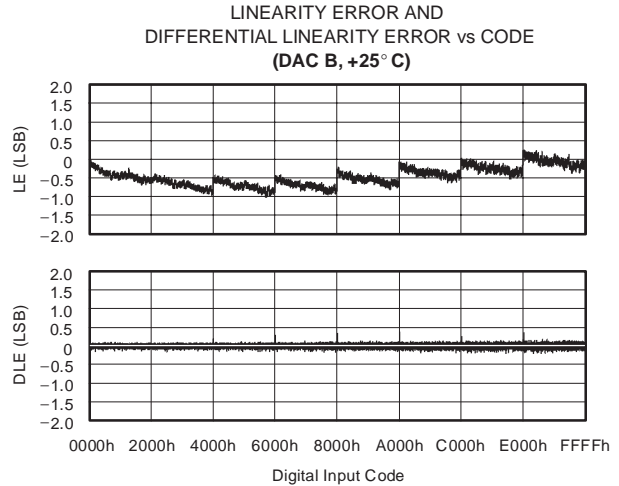

**Figure 2**

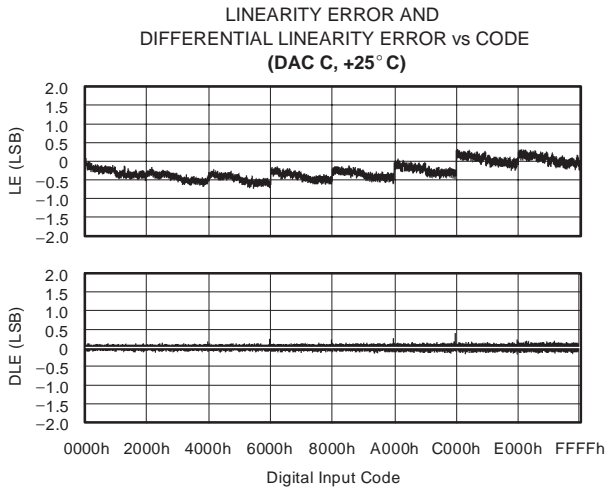

**Figure 3**

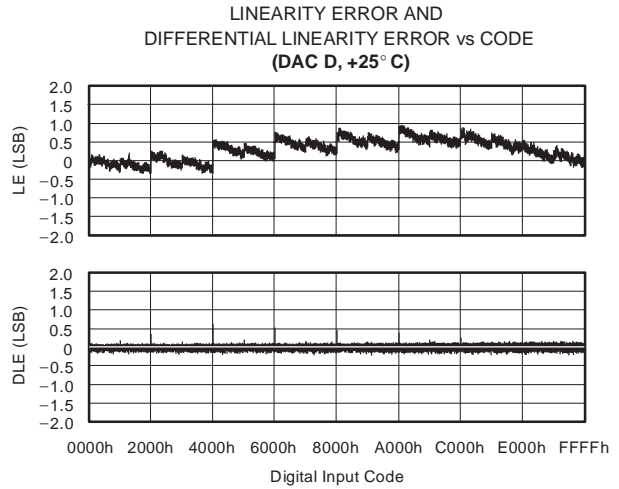

**Figure 4**

**TYPICAL CHARACTERISTICS:  $V_{SS} = 0V$  (+85°C)**

All specifications at  $T_A = 25^\circ C$ ,  $IOV_{DD} = V_{DD} = V_{CC} = +5V$ ,  $V_{SS} = 0V$ , representative unit, unless otherwise noted.

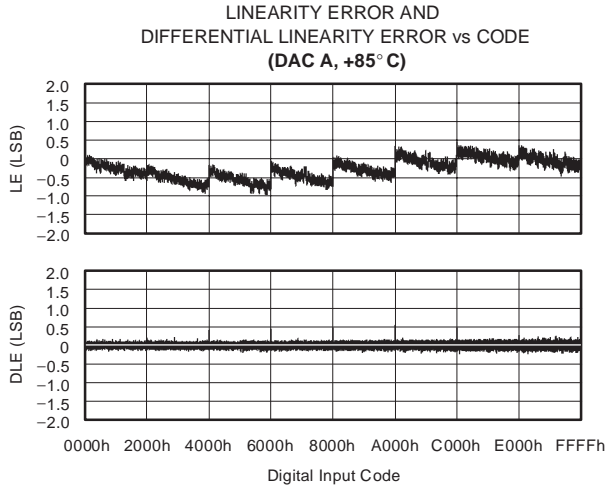

**Figure 5**

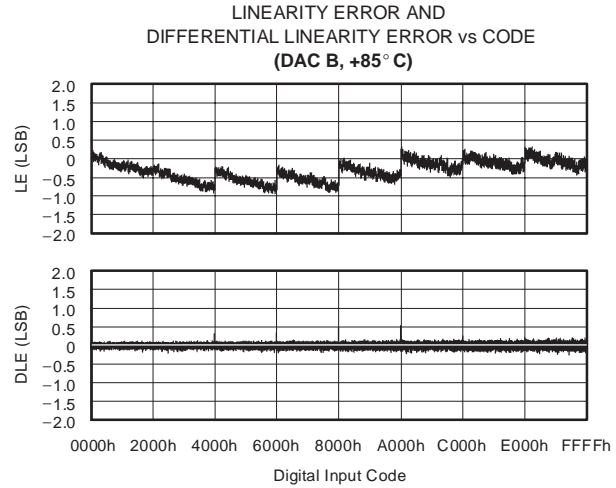

**Figure 6**

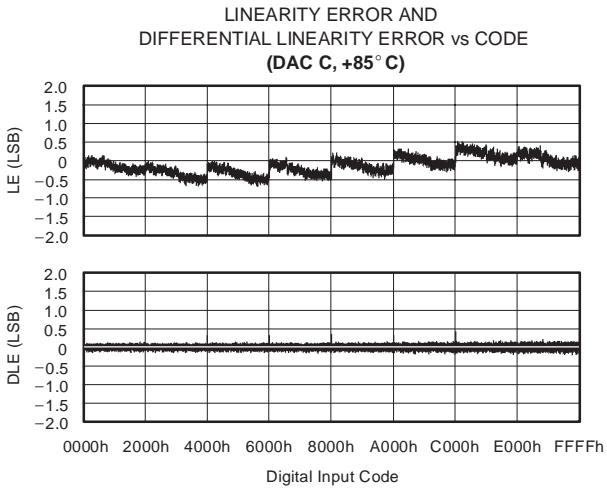

**Figure 7**

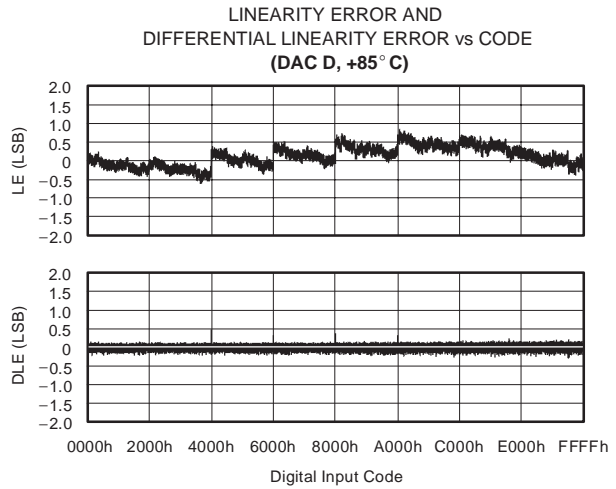

**Figure 8**

**TYPICAL CHARACTERISTICS:  $V_{SS} = 0V$  ( $-40^{\circ}C$ )**

All specifications at  $T_A = 25^{\circ}C$ ,  $IOV_{DD} = V_{DD} = V_{CC} = +5V$ ,  $V_{SS} = 0V$ , representative unit, unless otherwise noted.

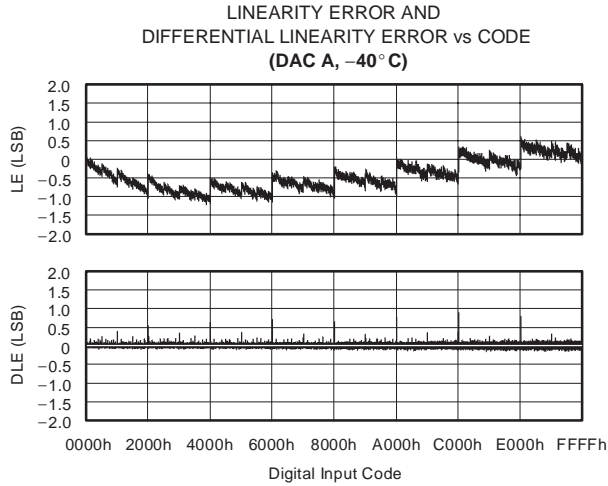

**Figure 9**

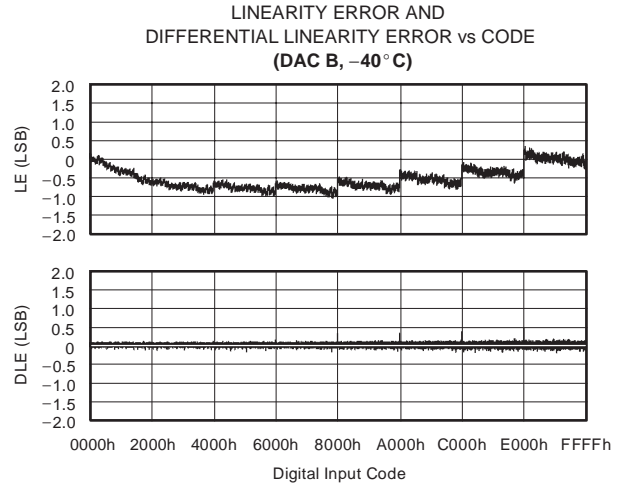

**Figure 10**

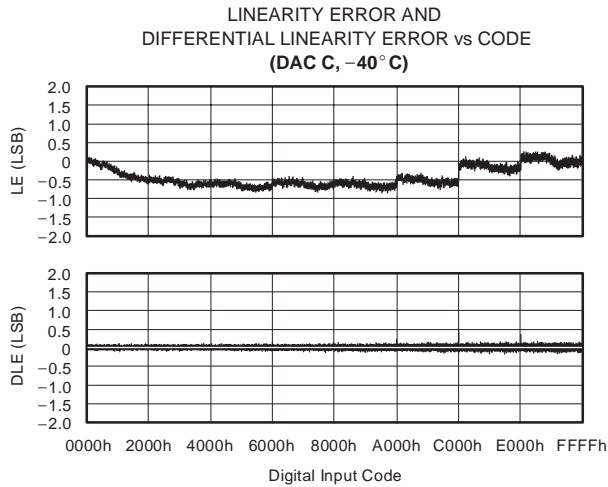

**Figure 11**

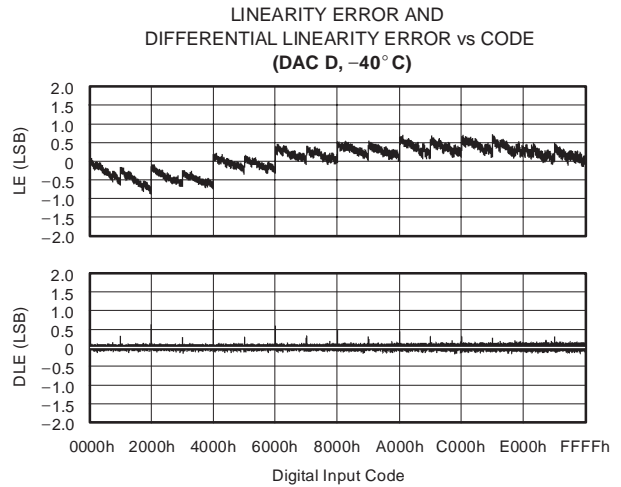

**Figure 12**

**TYPICAL CHARACTERISTICS:  $V_{SS} = 0V$**

All specifications at  $T_A = 25^\circ C$ ,  $IOV_{DD} = V_{DD} = V_{CC} = +5V$ ,  $V_{SS} = 0V$ , representative unit, unless otherwise noted.

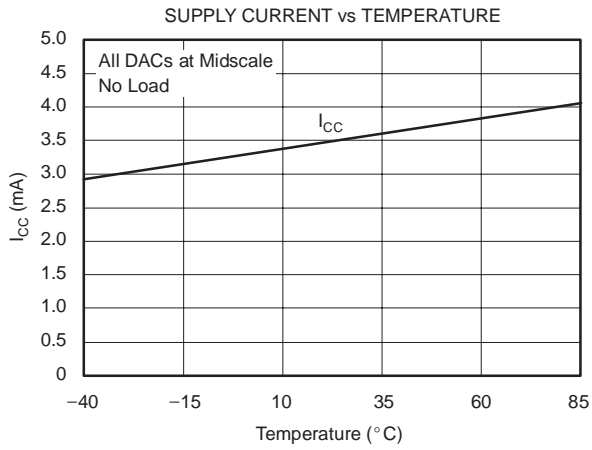

**Figure 13**

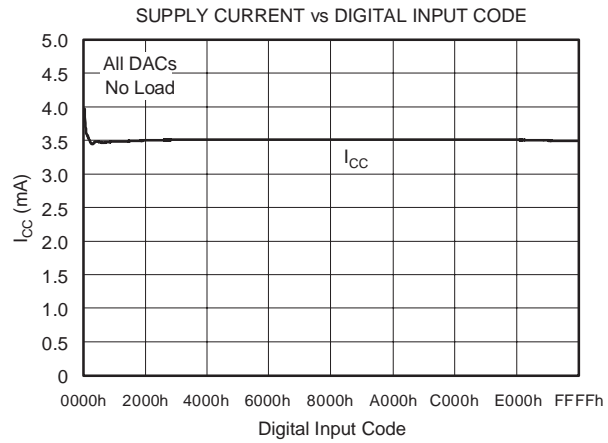

**Figure 14**

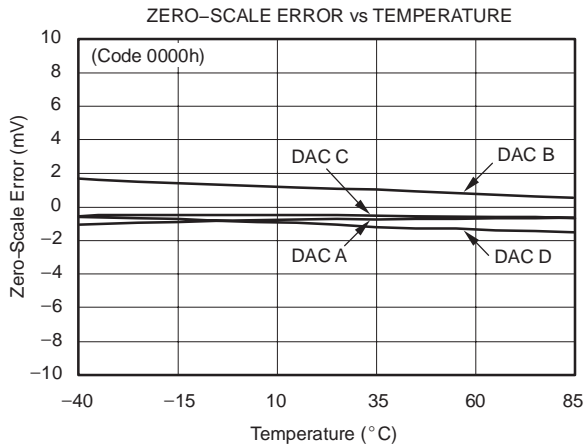

**Figure 15**

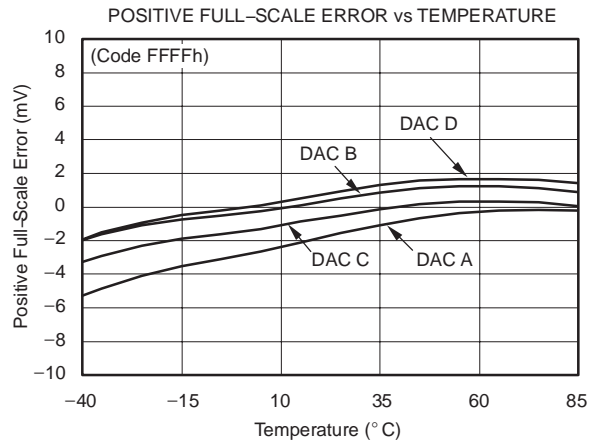

**Figure 16**

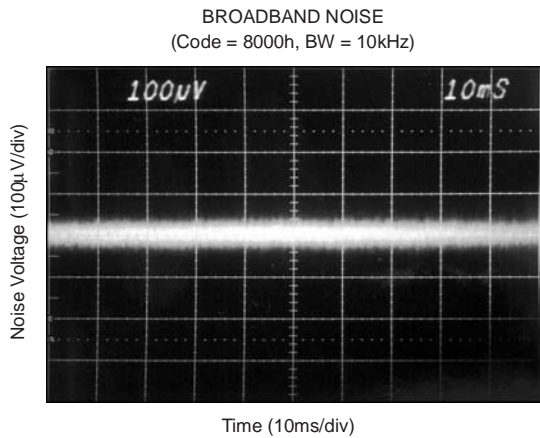

**Figure 17**

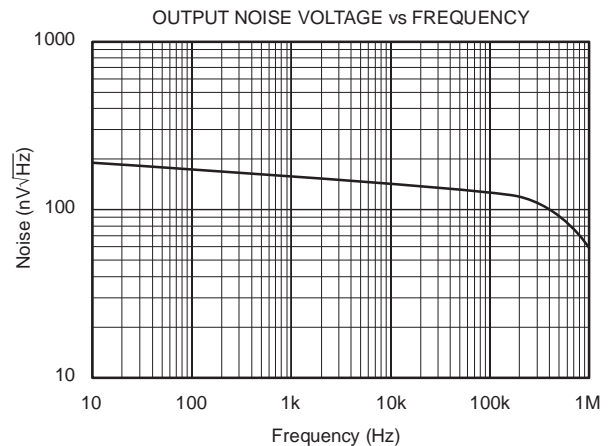

**Figure 18**

**TYPICAL CHARACTERISTICS:  $V_{SS} = 0V$  (continued)**

All specifications at  $T_A = 25^\circ C$ ,  $IOV_{DD} = V_{DD} = V_{CC} = +5V$ ,  $V_{SS} = 0V$ , representative unit, unless otherwise noted.

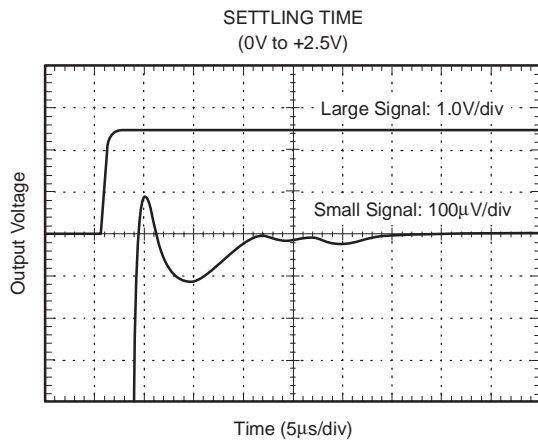

**Figure 19**

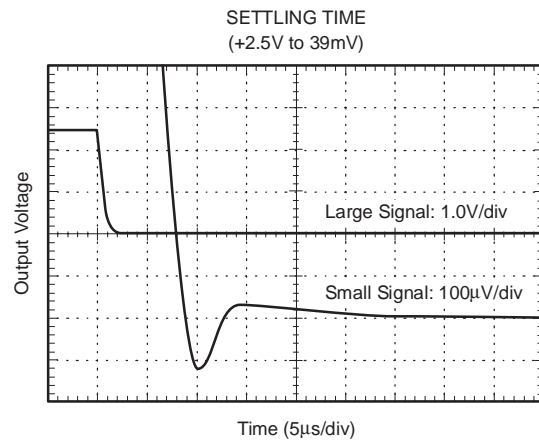

**Figure 20**

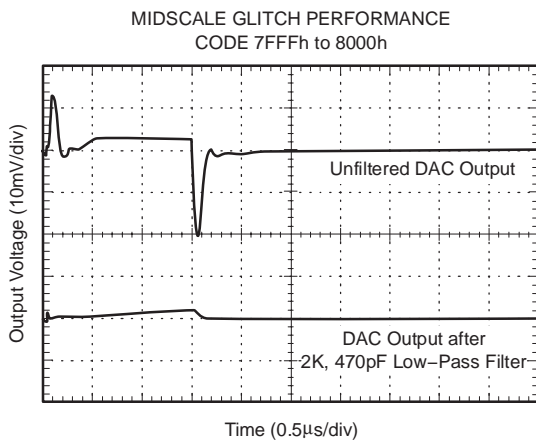

**Figure 21**

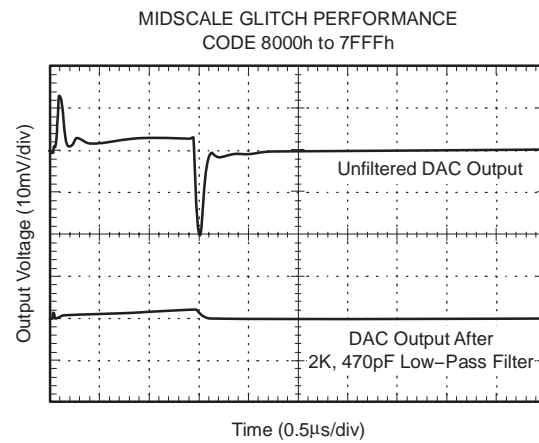

**Figure 22**

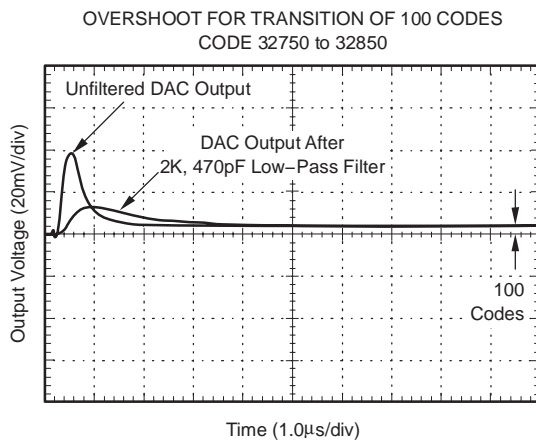

**Figure 23**

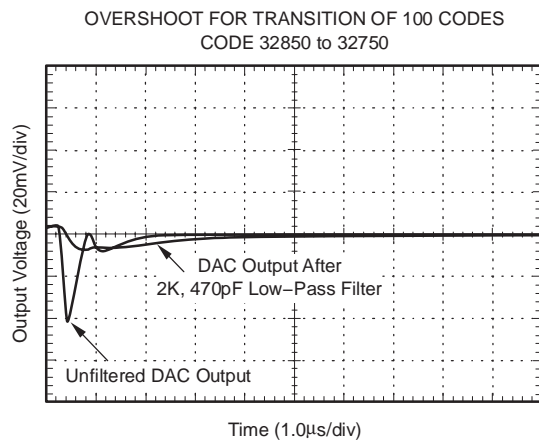

**Figure 24**

**TYPICAL CHARACTERISTICS:  $V_{SS} = 0V$  (continued)**

All specifications at  $T_A = 25^\circ C$ ,  $IOV_{DD} = V_{DD} = V_{CC} = +5V$ ,  $V_{SS} = 0V$ , representative unit, unless otherwise noted.

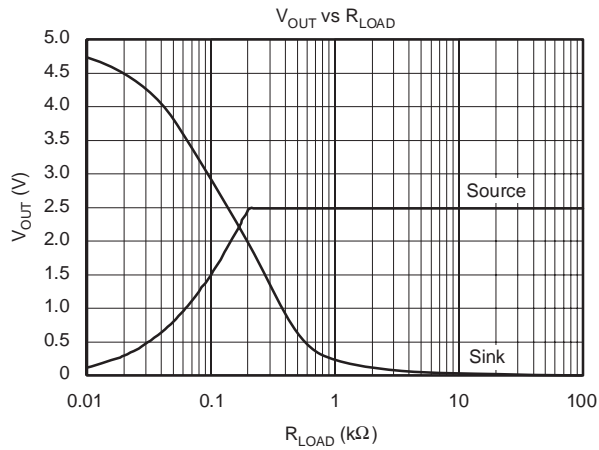

**Figure 25**

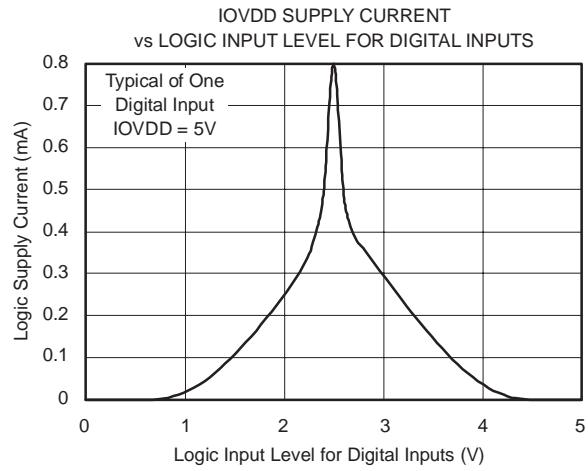

**Figure 26**

**TYPICAL CHARACTERISTICS:  $V_{SS} = -5V$  (+25°C)**

All specifications at  $T_A = 25^\circ C$ ,  $IOV_{DD} = V_{DD} = V_{CC} = +5V$ ,  $V_{SS} = -5V$ , representative unit, unless otherwise noted.

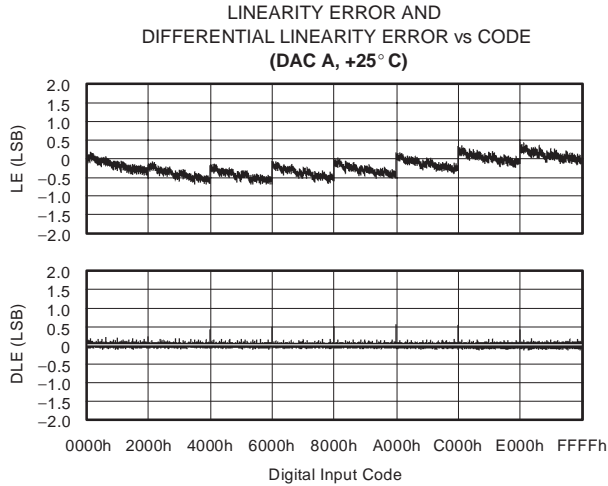

**Figure 27**

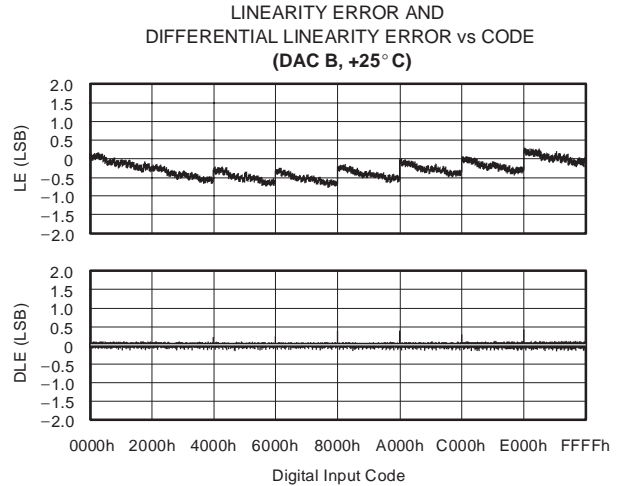

**Figure 28**

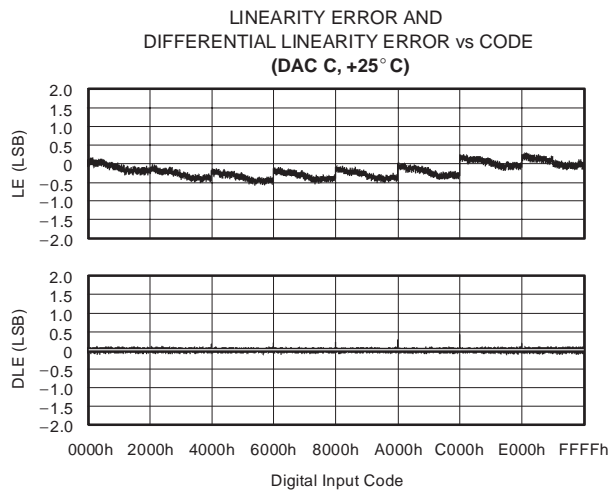

**Figure 29**

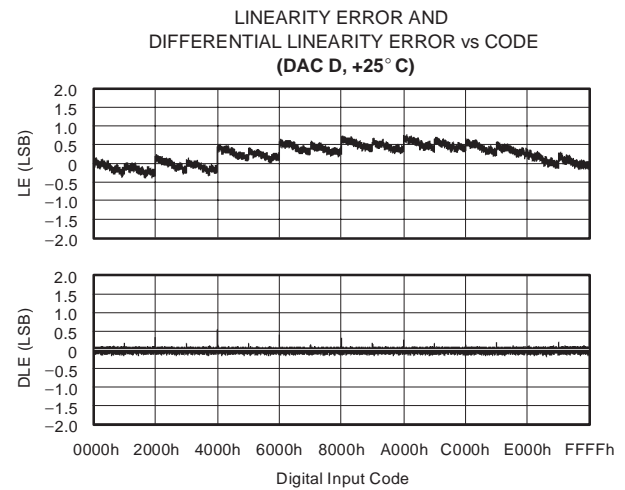

**Figure 30**

**TYPICAL CHARACTERISTICS:  $V_{SS} = -5V$  (+85°C)**

All specifications at  $T_A = 25^\circ C$ ,  $IOV_{DD} = V_{DD} = V_{CC} = +5V$ ,  $V_{SS} = -5V$ , representative unit, unless otherwise noted.

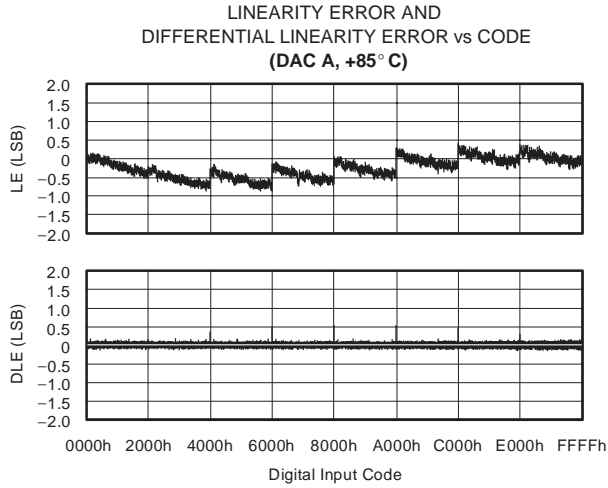

**Figure 31**

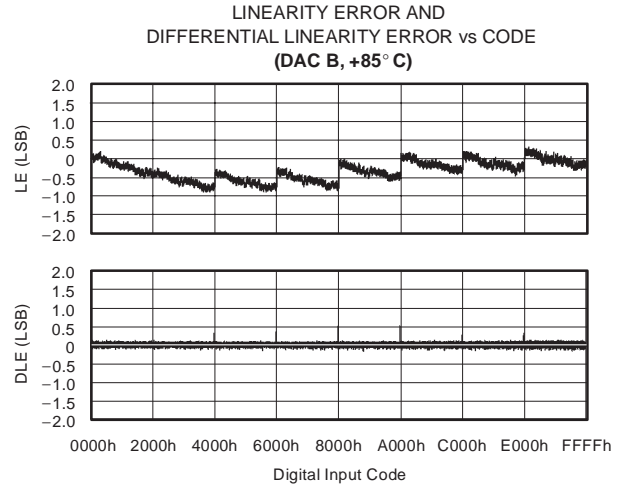

**Figure 32**

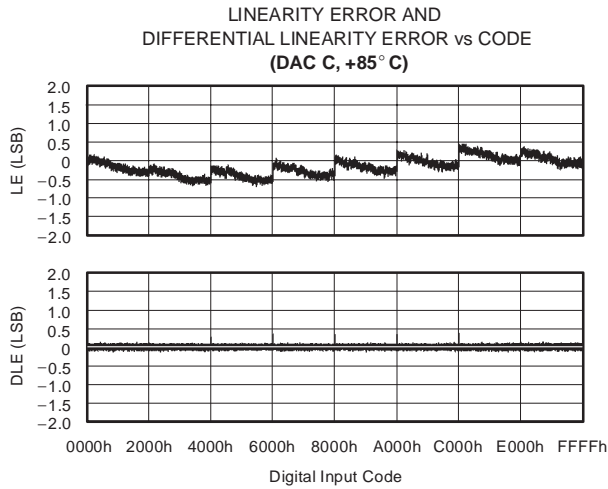

**Figure 33**

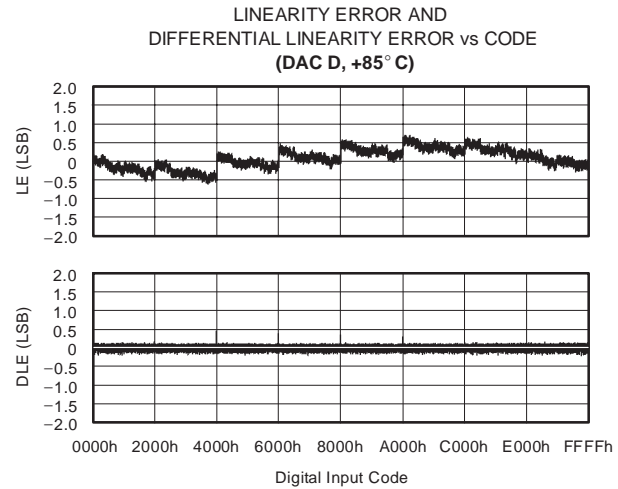

**Figure 34**

**TYPICAL CHARACTERISTICS:  $V_{SS} = -5V$  ( $-40^{\circ}C$ )**

All specifications at  $T_A = 25^{\circ}C$ ,  $IOV_{DD} = V_{DD} = V_{CC} = +5V$ ,  $V_{SS} = -5V$ , representative unit, unless otherwise noted.

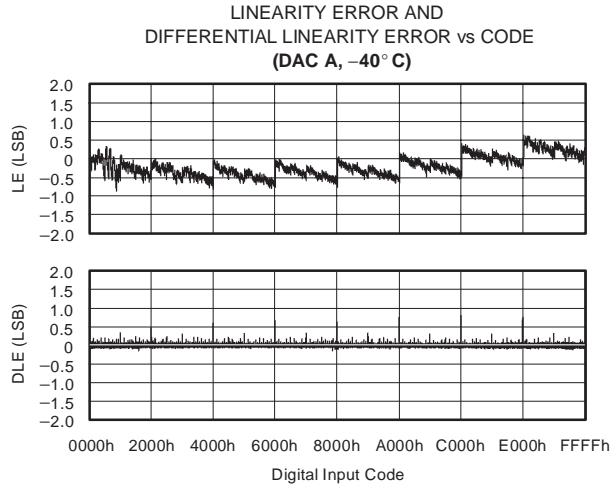

**Figure 35**

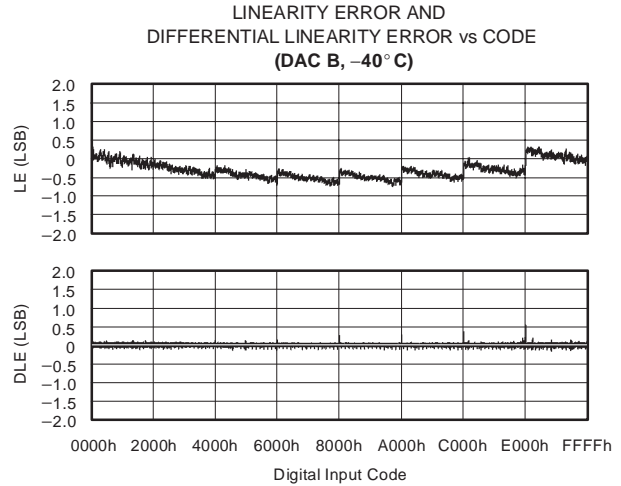

**Figure 36**

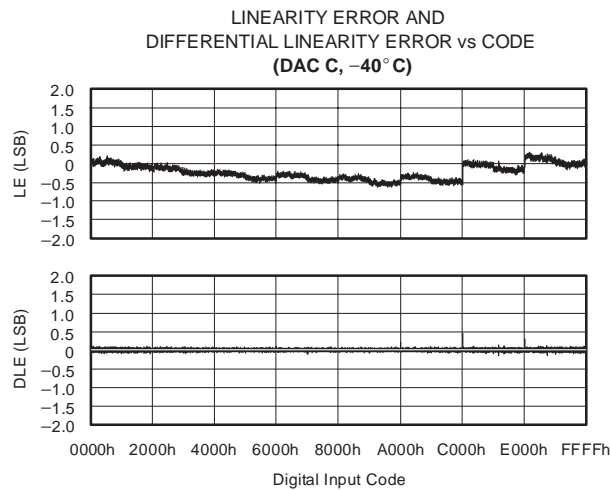

**Figure 37**

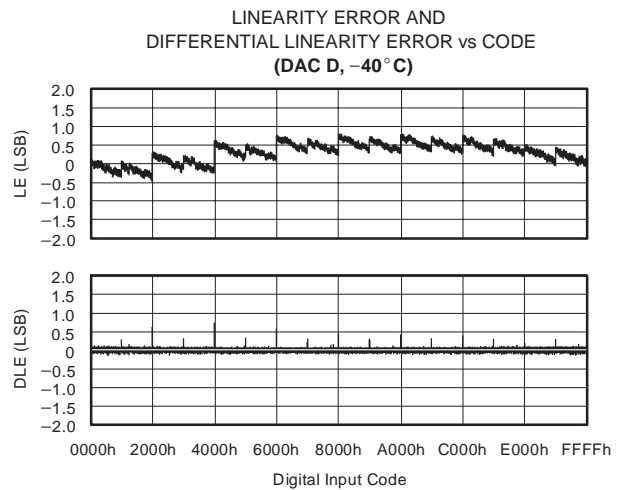

**Figure 38**

**TYPICAL CHARACTERISTICS:  $V_{SS} = -5V$**

All specifications at  $T_A = 25^\circ C$ ,  $IOV_{DD} = V_{DD} = V_{CC} = +5V$ ,  $V_{SS} = -5V$ , representative unit, unless otherwise noted.

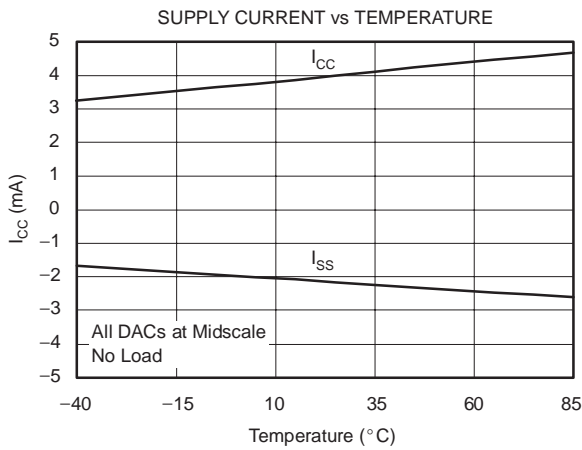

**Figure 39**

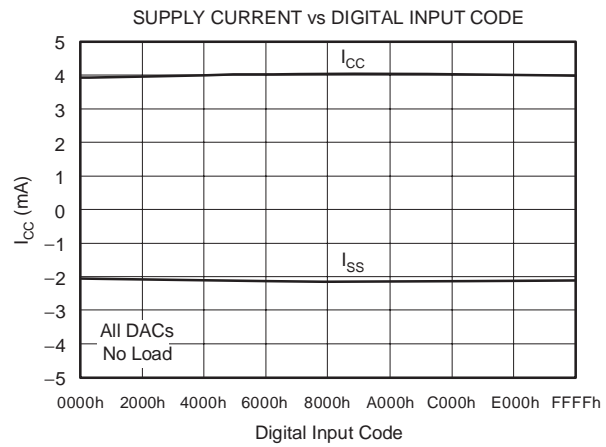

**Figure 40**

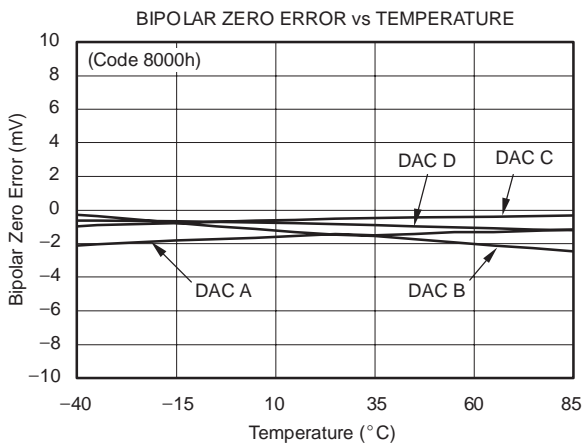

**Figure 41**

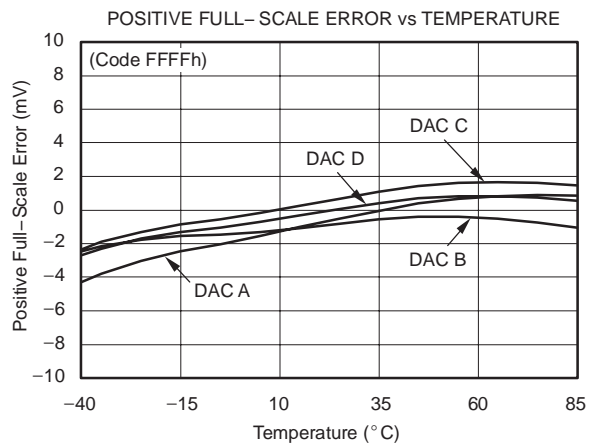

**Figure 42**

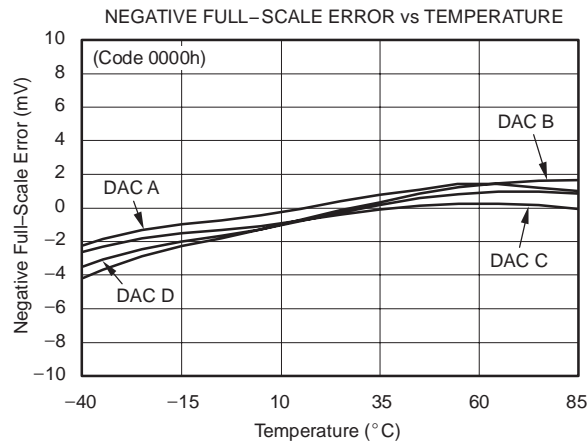

**Figure 43**

**TYPICAL CHARACTERISTICS:  $V_{SS} = -5V$  (continued)**

All specifications at  $T_A = 25^\circ C$ ,  $IOV_{DD} = V_{DD} = V_{CC} = +5V$ ,  $V_{SS} = -5V$ , representative unit, unless otherwise noted.

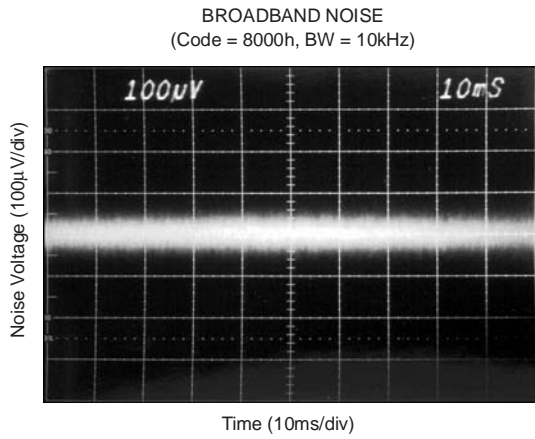

**Figure 44**

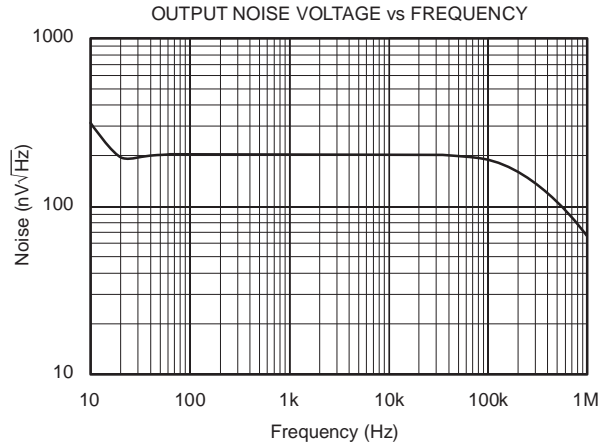

**Figure 45**

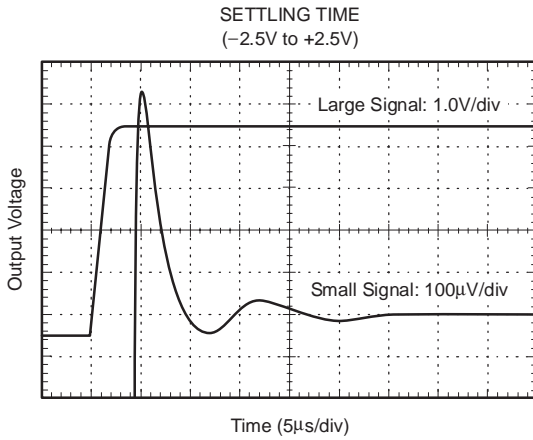

**Figure 46**

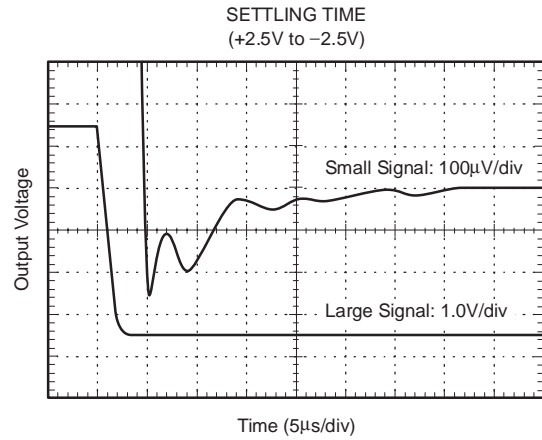

**Figure 47**

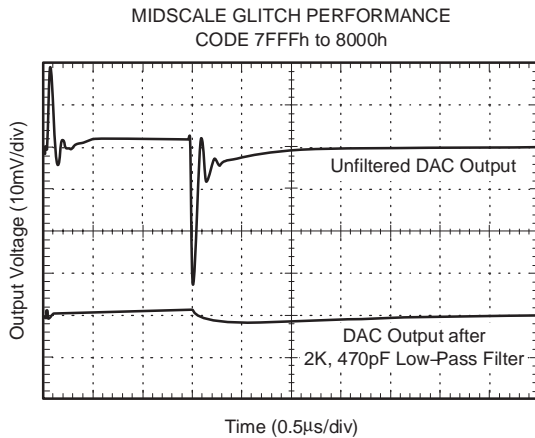

**Figure 48**

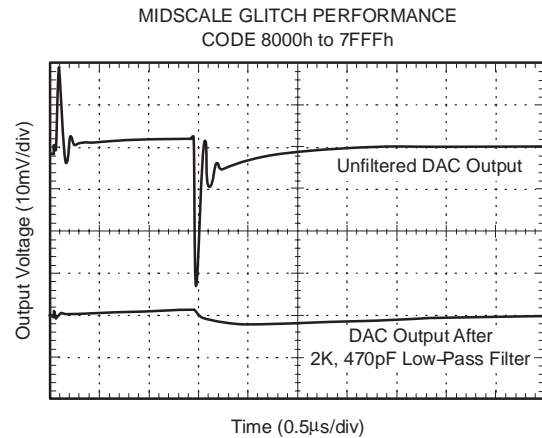

**Figure 49**

**TYPICAL CHARACTERISTICS:  $V_{SS} = -5V$  (continued)**

All specifications at  $T_A = 25^\circ C$ ,  $IOV_{DD} = V_{DD} = V_{CC} = +5V$ ,  $V_{SS} = -5V$ , representative unit, unless otherwise noted.

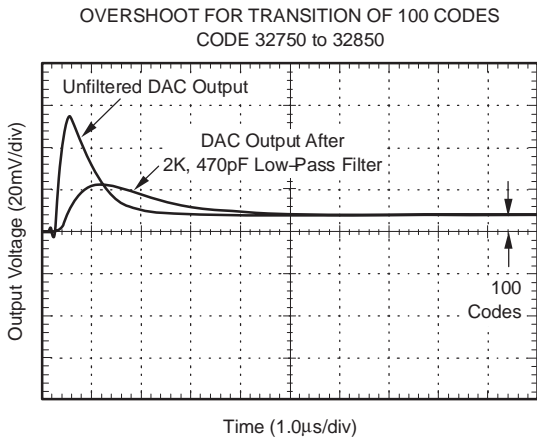

**Figure 50**

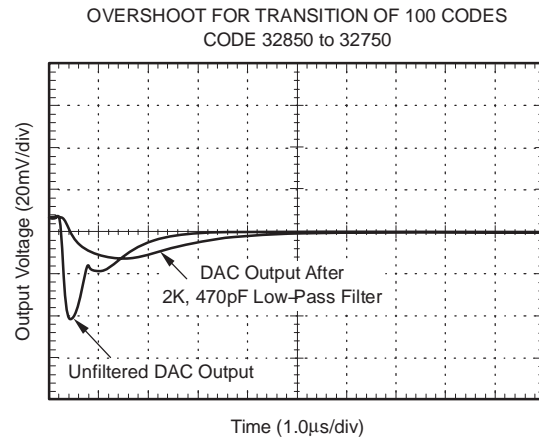

**Figure 51**

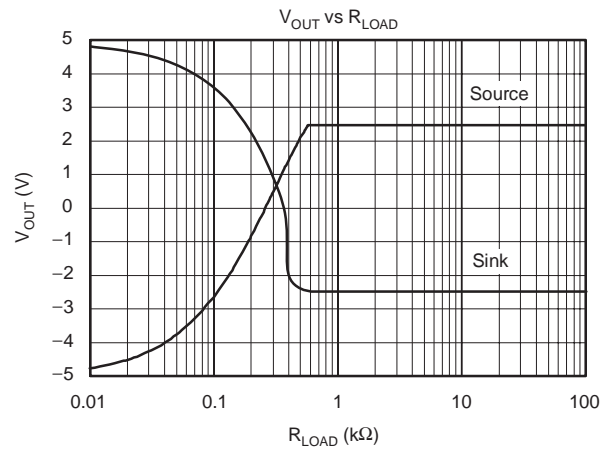
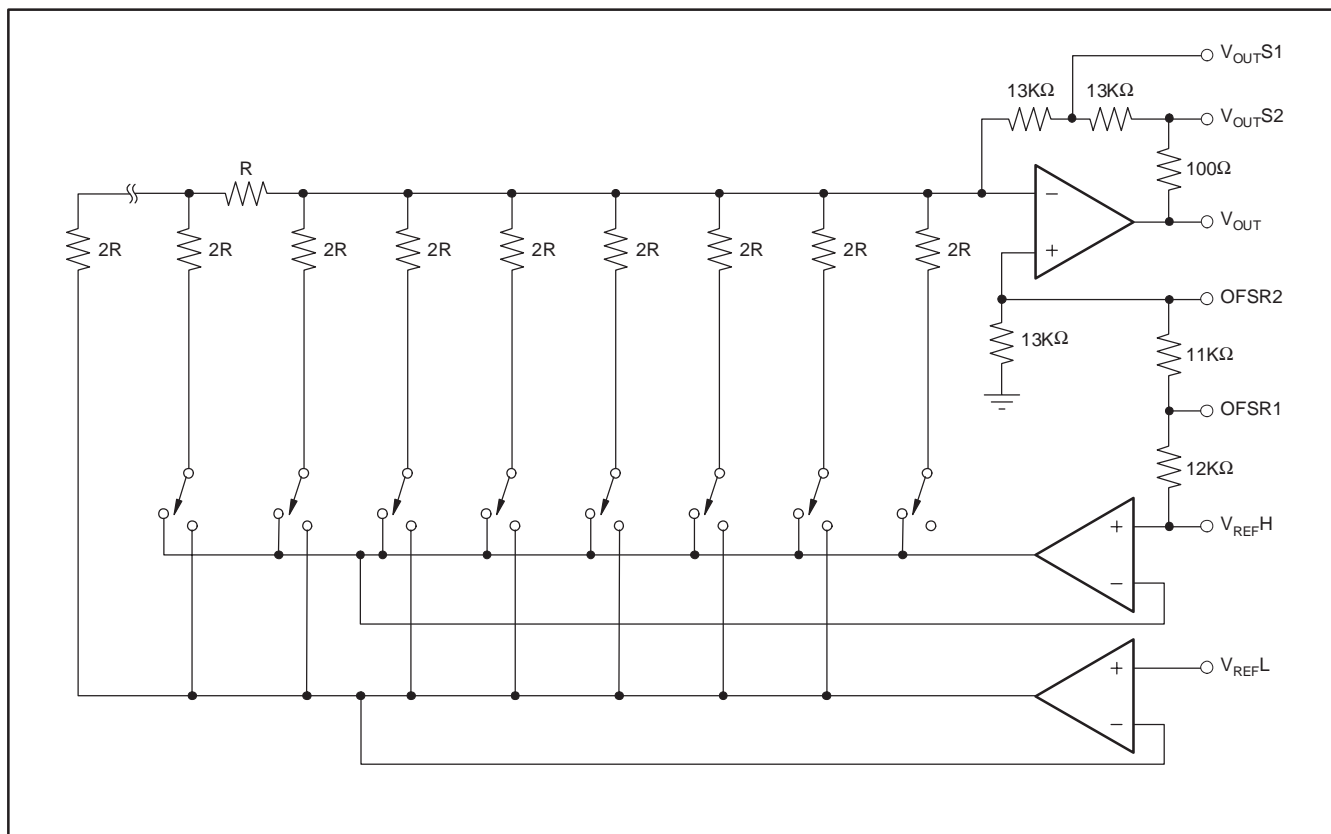

**Figure 52**

## THEORY OF OPERATION

The DAC7664 is a quad voltage output 16-bit DAC. The architecture is an R–2R ladder configuration with the three most significant bits (MSBs) segmented, followed by an operational amplifier that serves as a buffer. Each DAC has its own R–2R ladder network, segmented MSBs, and output op amp, as shown in Figure 53. The minimum voltage output (zero-scale) and maximum voltage output (full-scale) are set by the internal voltage references and the resistors associated with the output operational amplifier.

The digital input is a 16-bit parallel word and the DAC input registers offer readback capability. The converters can be powered from either a single +5V supply or a dual  $\pm 5V$  supply. The device offers a reset function that immediately sets all DAC output voltages and DAC registers to mid-scale (code 8000h) or to zero-scale, code 0000h. See Figure 54 and Figure 55 for the basic operation of the DAC7664.



**Figure 53. DAC7664 Architecture**

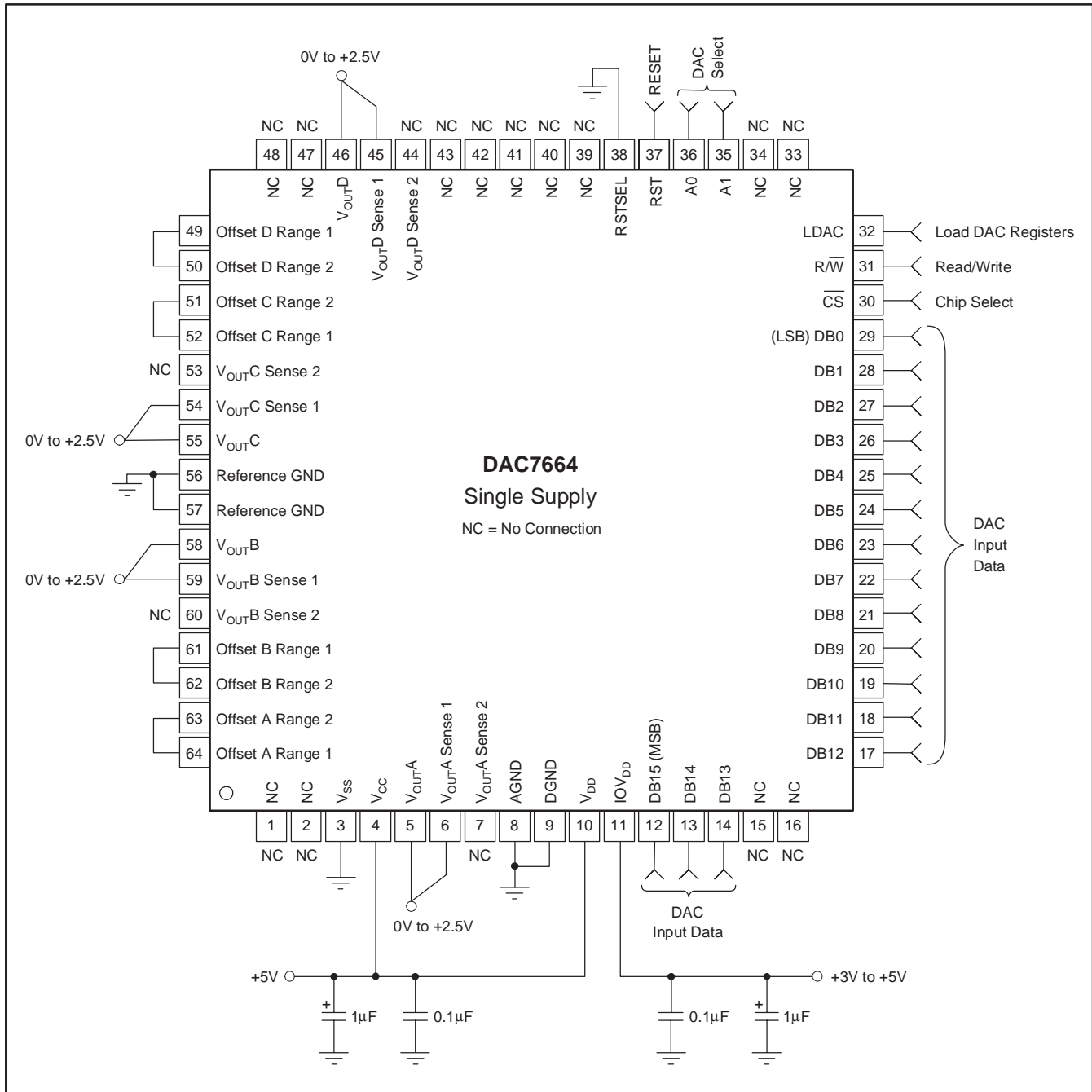
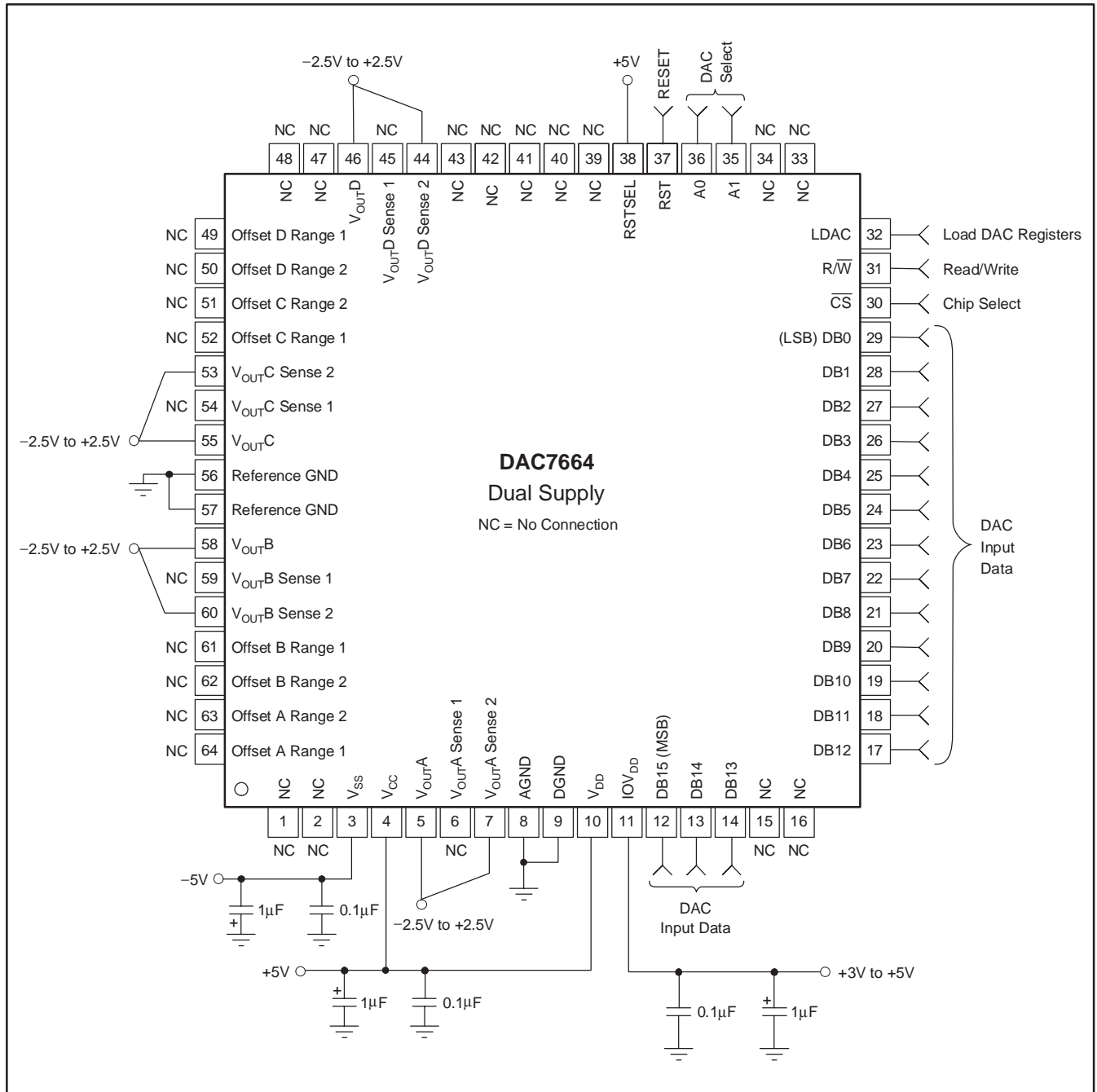

Figure 54. Basic Single-Supply Operation of the DAC7664



**Figure 55. Basic Dual-Supply Operation of the DAC7664**

**ANALOG OUTPUTS**

When  $V_{SS} = -5V$  (dual-supply operation), the output amplifier can swing to within 2.25V of the supply rails over a range of  $-40^{\circ}C$  to  $+85^{\circ}C$ . When  $V_{SS} = 0V$  (single-supply operation), and with  $R_{LOAD}$  also connected to ground, the output can swing to within 5mV of ground. Care must be taken when measuring the zero-scale error when  $V_{SS} = 0V$ . Since the output voltage cannot swing below ground, the output voltage may not change for the first few digital input codes (0000h, 0001h, 0002h, etc.) if the output amplifier has a negative offset.

Due to the high accuracy of these DACs, system design problems such as grounding and contact resistance are very important. A 16-bit converter with a 2.5V full-scale range has a 1LSB value of  $38\mu V$ . With a load current of 1mA, series wiring and connector resistance of only  $40m\Omega$  ( $R_{W2}$ ) will cause a voltage drop of  $40\mu V$ , as shown in Figure 56. To understand what this means in terms of system layout, the resistivity of a typical 1-ounce copper-clad printed circuit board is  $1/2 m\Omega$  per square. For a 1mA load, a 0.01-inch-wide printed circuit conductor 0.6 inches long will result in a voltage drop of  $30\mu V$ .

The DAC7664 offers a force and sense output configuration for the high open-loop gain output amplifier. This feature allows the loop around the output amplifier to be closed at the load (as shown in Figure 56), thus ensuring an accurate output voltage.

**DIGITAL INTERFACE**

Table 1 shows the basic control logic for the DAC7664. Note that each internal register is edge-triggered and not level-triggered. When the LDAC signal is transitioned to high, the digital word currently in the register is latched. The first set of registers (the input registers) are triggered via the A0, A1,  $R/\overline{W}$ , and  $\overline{CS}$  inputs. Only one of these registers is transparent at any given time.

The double-buffered architecture is designed mainly so each DAC input register can be written to at any time and then all DAC voltages updated simultaneously by the rising edge of LDAC. It also allows a DAC input register to be written to at any point and the DAC voltages to be synchronously changed via a trigger signal connected to LDAC.

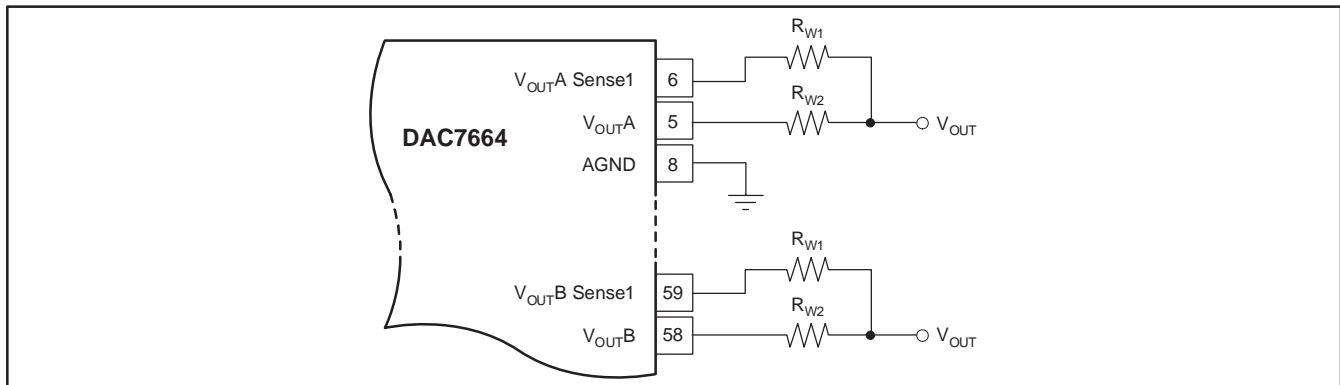

Figure 56. Analog Output Closed-Loop Configuration (1/2 DAC7664).  $R_W$  represents wiring resistances.

Table 1. DAC7664 Logic Truth Table

A1	A0	R/W	CS	RST	RSTSEL	LDAC	INPUT REGISTER	DAC REGISTER	MODE	DAC
L	L	L	L	H	X	X	Write	Hold	Write input	A
L	H	L	L	H	X	X	Write	Hold	Write input	B
H	L	L	L	H	X	X	Write	Hold	Write input	C
H	H	L	L	H	X	X	Write	Hold	Write input	D
L	L	H	L	H	X	X	Read	Hold	Read input	A
L	H	H	L	H	X	X	Read	Hold	Read input	B
H	L	H	L	H	X	X	Read	Hold	Read input	C
H	H	H	L	H	X	X	Read	Hold	Read input	D
X	X	X	H	H	X	↑	Hold	Write	Update	All
X	X	X	H	H	X	H	Hold	Hold	Hold	All
X	X	X	X	↑	L	X	Reset to zero	Reset to zero	Reset to zero	All
X	X	X	X	↑	H	X	Reset to mid-scale	Reset to mid-scale	Reset to mid-scale	All

### 3V TO 5V LOGIC INTERFACE

All of the digital input and output pins are compatible with any logic supply voltage between 3V and 5V. Connect the interface logic supply voltage to the IOV<sub>DD</sub> pin. Note that the internal digital logic operates from 5V, so the VDD pin must connect to a 5V supply.

### GLITCH SUPPRESSION CIRCUIT

Figure 21, Figure 22, Figure 48, and Figure 49 show the typical DAC output when switching between codes 7FFFh and 8000h. For R-2R ladder DACs, this is potentially the worst-case glitch condition, since every switch in the DAC changes state. To minimize the glitch energy at this and other code pairs with possible high-glitch outputs, an internal track-and-hold circuit is used to maintain the DAC output voltage at a nearly constant level during the internal switching interval. This track-and-hold circuit is activated only when the transition is at, or close to, one of the code pairs with the high-glitch possibility.

It is advisable to avoid digital transitions within 1μs of the rising edge of the LDAC signal. These signals can affect the charge on the track-and-hold capacitor, thus increasing the glitch energy.

### DIGITAL TIMING

Figure 57 and Table 2 provide detailed timing information for the digital interface of the DAC7664.

### DIGITAL INPUT CODING

The DAC7664 input data is in straight binary format. The output voltage for single-supply operation is given by Equation 1:

$$V_{\text{OUT}} = \frac{2.5 \times N}{65,536} \quad (1)$$

where N is the digital input code.

This equation does not include the effects of offset (zero-scale) or gain (full-scale) errors.

The output for the dual supply operation is given by Equation 2:

$$V_{\text{OUT}} = \frac{5 \times N}{65,536} - 2.5 \quad (2)$$

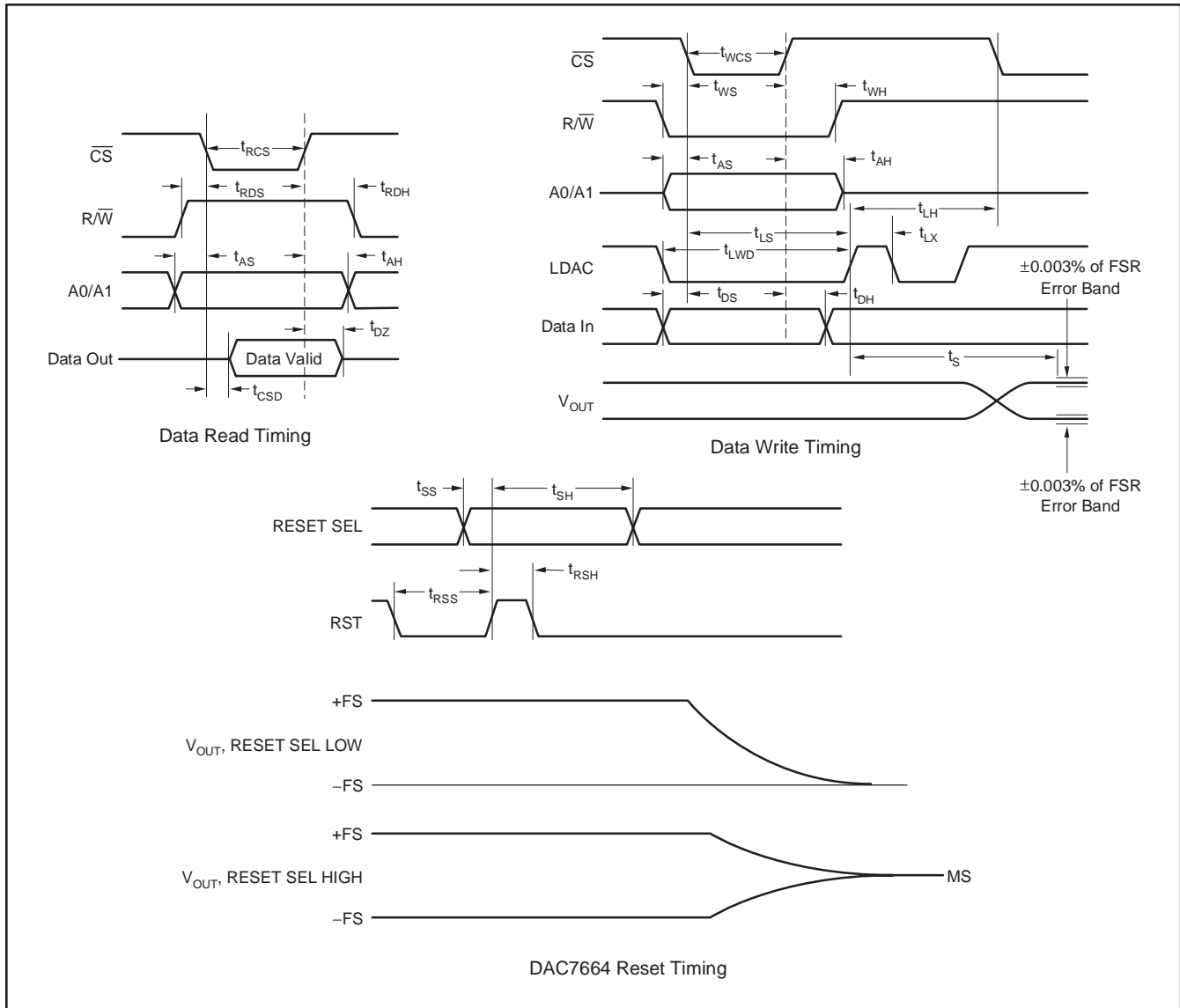

Figure 57. Digital Input and Output Timing

**Table 2. Timing Specifications for Figure 57**

SYMBOL	DESCRIPTION	MIN	TYP	MAX	UNITS
t <sub>RCS</sub>	$\overline{CS}$ low for read	150			ns
t <sub>RDS</sub>	R/ $\overline{W}$ high to $\overline{CS}$ low	10			ns
t <sub>RDH</sub>	R/ $\overline{W}$ high after $\overline{CS}$ high	10			ns
t <sub>DZ</sub>	$\overline{CS}$ high to data bus in high impedance	10		100	ns
t <sub>CSD</sub>	$\overline{CS}$ low to data bus valid		100	150	ns
t <sub>WCS</sub>	$\overline{CS}$ low for write	40			ns
t <sub>WS</sub>	R/ $\overline{W}$ low to $\overline{CS}$ low	0			ns
t <sub>WH</sub>	R/ $\overline{W}$ low after $\overline{CS}$ high	10			ns
t <sub>AS</sub>	Address valid to $\overline{CS}$ low	0			ns
t <sub>AH</sub>	Address valid after $\overline{CS}$ high	10			ns
t <sub>LS</sub>	$\overline{CS}$ low to LDAC high	30			ns
t <sub>LH</sub>	$\overline{CS}$ low after LDAC high	100			ns
t <sub>LX</sub>	LDAC high	100			ns
t <sub>DS</sub>	Data valid to $\overline{CS}$ low	0			ns
t <sub>DH</sub>	Data valid after $\overline{CS}$ low	10			ns
t <sub>LWD</sub>	LDAC low	100			ns
t <sub>SS</sub>	RSTSEL valid before RST high	0			ns
t <sub>SH</sub>	RSTSEL valid after RST high	200			ns
t <sub>RSS</sub>	RSTSEL low before RST high	10			ns
t <sub>RSH</sub>	RSTSEL low after RST high	10			ns
t <sub>S</sub>	Settling time		12		μs

**PACKAGING INFORMATION**

Orderable Device	Status (1)	Package Type	Package Drawing	Pins	Package Qty	Eco Plan (2)	Lead/Ball Finish (6)	MSL Peak Temp (3)	Op Temp (°C)	Device Marking (4/5)	Samples
DAC7664YBT	ACTIVE	LQFP	PM	64	250	Green (RoHS & no Sb/Br)	NIPDAU-DCC	Level-3-260C-168 HR	-40 to 85	DAC7664Y B	<a href="#">Samples</a>
DAC7664YCT	ACTIVE	LQFP	PM	64	250	Green (RoHS & no Sb/Br)	NIPDAU-DCC	Level-3-260C-168 HR	-40 to 85	DAC7664Y C	<a href="#">Samples</a>
DAC7664YCTG4	ACTIVE	LQFP	PM	64	250	Green (RoHS & no Sb/Br)	NIPDAU-DCC	Level-3-260C-168 HR	-40 to 85	DAC7664Y C	<a href="#">Samples</a>
DAC7664YT	ACTIVE	LQFP	PM	64	250	Green (RoHS & no Sb/Br)	NIPDAU-DCC	Level-3-260C-168 HR	-40 to 85	DAC7664Y	<a href="#">Samples</a>

(1) The marketing status values are defined as follows:

**ACTIVE:** Product device recommended for new designs.

**LIFEBUY:** TI has announced that the device will be discontinued, and a lifetime-buy period is in effect.

**NRND:** Not recommended for new designs. Device is in production to support existing customers, but TI does not recommend using this part in a new design.

**PREVIEW:** Device has been announced but is not in production. Samples may or may not be available.

**OBSOLETE:** TI has discontinued the production of the device.

(2) **RoHS:** TI defines "RoHS" to mean semiconductor products that are compliant with the current EU RoHS requirements for all 10 RoHS substances, including the requirement that RoHS substance do not exceed 0.1% by weight in homogeneous materials. Where designed to be soldered at high temperatures, "RoHS" products are suitable for use in specified lead-free processes. TI may reference these types of products as "Pb-Free".

**RoHS Exempt:** TI defines "RoHS Exempt" to mean products that contain lead but are compliant with EU RoHS pursuant to a specific EU RoHS exemption.

**Green:** TI defines "Green" to mean the content of Chlorine (Cl) and Bromine (Br) based flame retardants meet JS709B low halogen requirements of <=1000ppm threshold. Antimony trioxide based flame retardants must also meet the <=1000ppm threshold requirement.

(3) MSL, Peak Temp. - The Moisture Sensitivity Level rating according to the JEDEC industry standard classifications, and peak solder temperature.

(4) There may be additional marking, which relates to the logo, the lot trace code information, or the environmental category on the device.

(5) Multiple Device Markings will be inside parentheses. Only one Device Marking contained in parentheses and separated by a "-" will appear on a device. If a line is indented then it is a continuation of the previous line and the two combined represent the entire Device Marking for that device.

(6) Lead/Ball Finish - Orderable Devices may have multiple material finish options. Finish options are separated by a vertical ruled line. Lead/Ball Finish values may wrap to two lines if the finish value exceeds the maximum column width.

**Important Information and Disclaimer:**The information provided on this page represents TI's knowledge and belief as of the date that it is provided. TI bases its knowledge and belief on information provided by third parties, and makes no representation or warranty as to the accuracy of such information. Efforts are underway to better integrate information from third parties. TI has taken and

continues to take reasonable steps to provide representative and accurate information but may not have conducted destructive testing or chemical analysis on incoming materials and chemicals. TI and TI suppliers consider certain information to be proprietary, and thus CAS numbers and other limited information may not be available for release.

In no event shall TI's liability arising out of such information exceed the total purchase price of the TI part(s) at issue in this document sold by TI to Customer on an annual basis.

## TAPE AND REEL INFORMATION



### QUADRANT ASSIGNMENTS FOR PIN 1 ORIENTATION IN TAPE



\*All dimensions are nominal

Device	Package Type	Package Drawing	Pins	SPQ	Reel Diameter (mm)	Reel Width W1 (mm)	A0 (mm)	B0 (mm)	K0 (mm)	P1 (mm)	W (mm)	Pin1 Quadrant
DAC7664YBT	LQFP	PM	64	250	180.0	24.4	13.0	13.0	2.1	16.0	24.0	Q2
DAC7664YCT	LQFP	PM	64	250	180.0	24.4	13.0	13.0	2.1	16.0	24.0	Q2
DAC7664YT	LQFP	PM	64	250	180.0	24.4	13.0	13.0	2.1	16.0	24.0	Q2

**TAPE AND REEL BOX DIMENSIONS**

\*All dimensions are nominal

Device	Package Type	Package Drawing	Pins	SPQ	Length (mm)	Width (mm)	Height (mm)
DAC7664YBT	LQFP	PM	64	250	213.0	191.0	55.0
DAC7664YCT	LQFP	PM	64	250	213.0	191.0	55.0
DAC7664YT	LQFP	PM	64	250	213.0	191.0	55.0

# PM0064A

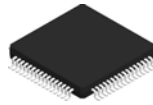

# PACKAGE OUTLINE

LQFP - 1.6 mm max height

PLASTIC QUAD FLATPACK

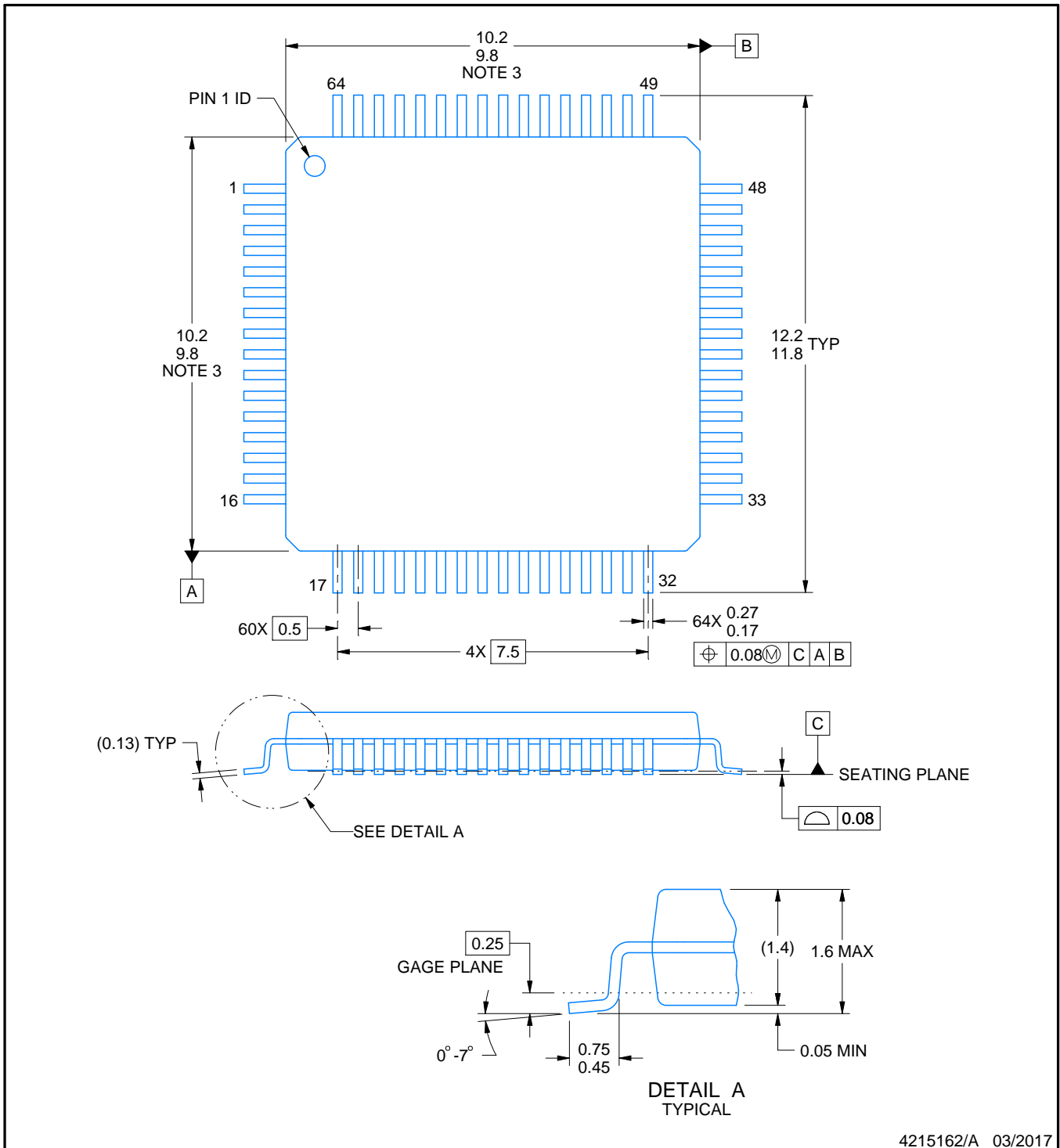

4215162/A 03/2017

**NOTES:**

1. All linear dimensions are in millimeters. Any dimensions in parenthesis are for reference only. Dimensioning and tolerancing per ASME Y14.5M.
2. This drawing is subject to change without notice.
3. This dimension does not include mold flash, protrusions, or gate burrs. Mold flash, protrusions, or gate burrs shall not exceed 0.15 mm per side.
4. Reference JEDEC registration MS-026.

# EXAMPLE BOARD LAYOUT

PM0064A

LQFP - 1.6 mm max height

PLASTIC QUAD FLATPACK

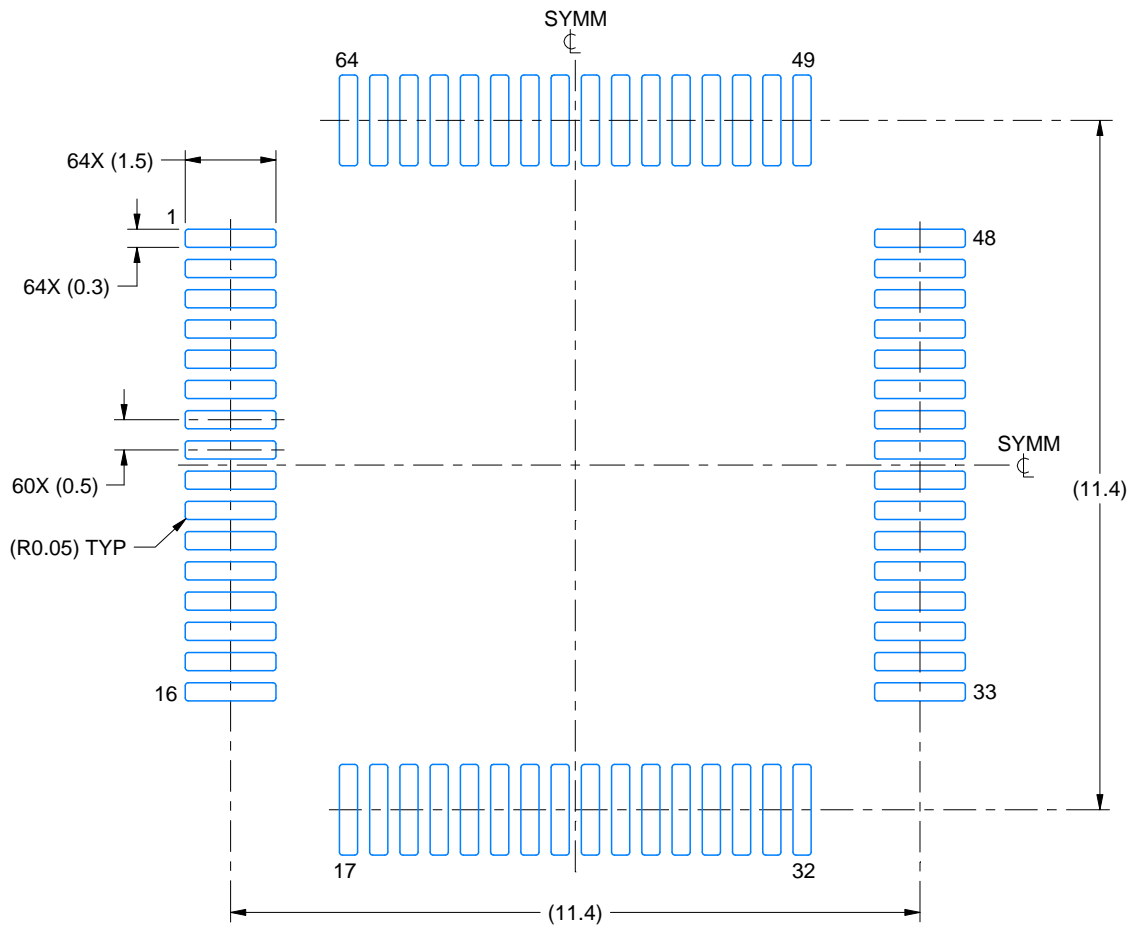

LAND PATTERN EXAMPLE  
EXPOSED METAL SHOWN  
SCALE:8X

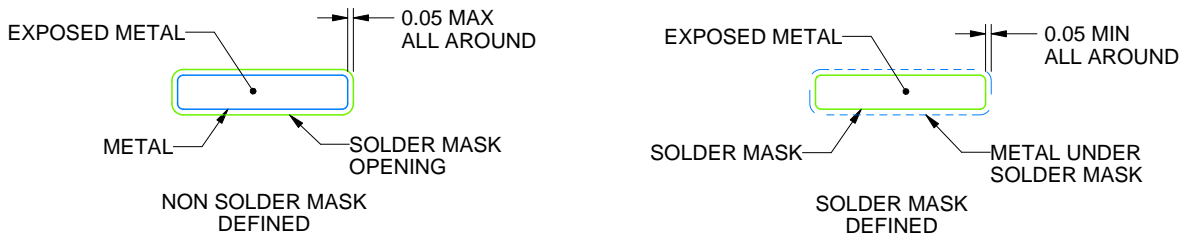

SOLDER MASK DETAILS

4215162/A 03/2017

NOTES: (continued)

5. Publication IPC-7351 may have alternate designs.
6. Solder mask tolerances between and around signal pads can vary based on board fabrication site.
7. For more information, see Texas Instruments literature number SLMA004 ([www.ti.com/lit/slma004](http://www.ti.com/lit/slma004)).

# EXAMPLE STENCIL DESIGN

PM0064A

LQFP - 1.6 mm max height

PLASTIC QUAD FLATPACK

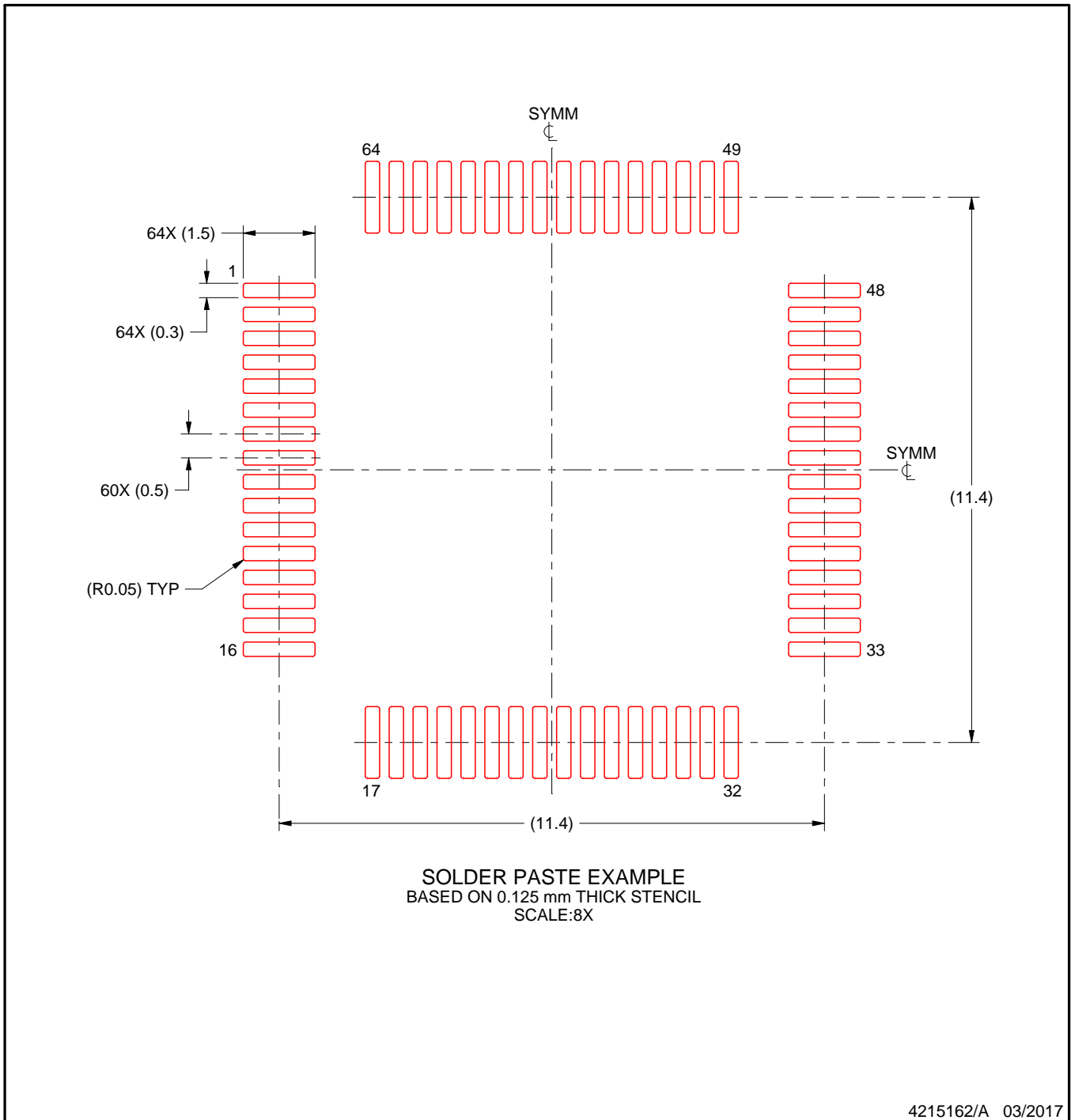

NOTES: (continued)

8. Laser cutting apertures with trapezoidal walls and rounded corners may offer better paste release. IPC-7525 may have alternate design recommendations.
9. Board assembly site may have different recommendations for stencil design.

## IMPORTANT NOTICE AND DISCLAIMER

TI PROVIDES TECHNICAL AND RELIABILITY DATA (INCLUDING DATASHEETS), DESIGN RESOURCES (INCLUDING REFERENCE DESIGNS), APPLICATION OR OTHER DESIGN ADVICE, WEB TOOLS, SAFETY INFORMATION, AND OTHER RESOURCES "AS IS" AND WITH ALL FAULTS, AND DISCLAIMS ALL WARRANTIES, EXPRESS AND IMPLIED, INCLUDING WITHOUT LIMITATION ANY IMPLIED WARRANTIES OF MERCHANTABILITY, FITNESS FOR A PARTICULAR PURPOSE OR NON-INFRINGEMENT OF THIRD PARTY INTELLECTUAL PROPERTY RIGHTS.

These resources are intended for skilled developers designing with TI products. You are solely responsible for (1) selecting the appropriate TI products for your application, (2) designing, validating and testing your application, and (3) ensuring your application meets applicable standards, and any other safety, security, or other requirements. These resources are subject to change without notice. TI grants you permission to use these resources only for development of an application that uses the TI products described in the resource. Other reproduction and display of these resources is prohibited. No license is granted to any other TI intellectual property right or to any third party intellectual property right. TI disclaims responsibility for, and you will fully indemnify TI and its representatives against, any claims, damages, costs, losses, and liabilities arising out of your use of these resources.

TI's products are provided subject to TI's Terms of Sale ([www.ti.com/legal/termsofsale.html](http://www.ti.com/legal/termsofsale.html)) or other applicable terms available either on [ti.com](http://ti.com) or provided in conjunction with such TI products. TI's provision of these resources does not expand or otherwise alter TI's applicable warranties or warranty disclaimers for TI products.

Mailing Address: Texas Instruments, Post Office Box 655303, Dallas, Texas 75265  
Copyright © 2020, Texas Instruments Incorporated