

LM36011EVM User Guide

The Texas Instruments LM36011EVM evaluation module (EVM) helps designers evaluate the operation and performance of the LM36011 Inductorless Single-LED Driver with 1.5-A High-Side Current Source. The device offers configurability via I²C-compatible interface. It can be enabled in flash or torch mode via the I²C interface or externally using the STROBE pin. The module utilizes one LED (D1) mounted on the EVM.

The EVM contains one inductorless, single-LED flash driver (see [Table 1](#)).

Table 1. Device and Package Configurations

FLASH LED DRIVER	DEVICE	PACKAGE
U1	LM36011	0.35-mm pitch 8-pin DSBGA

Contents

1	Setup	3
2	Software.....	7
3	GUI Operation	19
4	Schematic	25
5	Board Layout.....	26
6	LM36011EVM Bill of Materials	28

List of Figures

1	STROBE Jumper Settings.....	3
2	VIO Jumper Setting.....	3
3	LED Current Measurements Jumper.....	4
4	LM36011EVM Jumper Configuration	4
5	LED Warning	5
6	LM36011EVM Test Setup	6
7	MSP432 LaunchPad Jumper Configuration.....	7
8	Driver Download Website (Part 1).....	8
9	Driver Download Website (Part 2).....	8
10	U.S. Government Export Approval (Part 1)	8
11	U.S. Government Export Approval (Part 2)	9
12	Driver Download (Part 1)	9
13	Driver Download (Part 2).....	10
14	Driver Zip Folder	10
15	Extract Files	10
16	Driver Folder	11
17	Driver Folder (Inside)	11
18	Driver Setup	11
19	Driver License Agreement	12
20	Driver Installation Directory	12
21	Device Driver Installation (Part 1).....	12
22	Device Driver Installation (Part 2).....	13

23	Device Driver Installation (Part 3)	13
24	EVM Software Zip File	14
25	EVM Software Extract Files	14
26	EVM Software Setup File	15
27	EVM Software Setup Wizard	15
28	EVM Software License Agreement	16
29	EVM Software Installation Directory	16
30	EVM Software Installation (Part 1)	17
31	EVM Software Installation (Part 2)	17
32	EVM Software Installation (Part 3)	18
33	EVM Software Desktop Shortcut	18
34	LM3601X Selection	19
35	Status Bar	19
36	Menu	19
37	LM36011EVM Information View	20
38	LM36011EVM Register View	21
39	LM36011EVM Control View	21
40	I2C Interface Fields	22
41	Flash Settings	22
42	Torch Settings	23
43	Write Buttons	23
44	Flags	24
45	I/O Pin Controls	24
46	LM36011EVM Schematic	25
47	Top Assembly Layer	26
48	Middle Layer 1 Routing	26
49	Bottom Assembly Layer (UNMIRRORED)	27

List of Tables

1	Device and Package Configurations	1
2	Bill of Materials	28

Trademarks

LaunchPad is a trademark of Texas Instruments.
All other trademarks are the property of their respective owners.

1 Setup

This section describes the jumpers and connectors on the EVM as well as how to properly connect, set up, and use the LM36011EVM.

1.1 Input/Output Connector Description

VIN, GND (Banana Connectors) – These are the power input terminals for the driver and provide a power (VIN) and ground (GND) connection to allow the user to attach the EVM to a cable harness.

VIN (Test Point) – This pin can be used to measure the input voltage.

STROBE (Jumper J2) – STROBE is an active high hardware flash enable. This pin can be used to monitor the STROBE signal.

PWM, STROBE, GND (Jumper J3) – This jumper provides an external method for initiating a flash event. The STROBE pin is connected to ground via a 300-k Ω resistor internal to the LM36011EVM. To externally drive this pin, either connect a control signal directly to the STROBE pin of the connector or place a jumper between the pins STROBE (J3<2>) and PWM (J3<1>). PWM can be configured as a time-adjustable voltage pulse via the General User Interface (GUI) software provided or can be driven externally using a function generator.

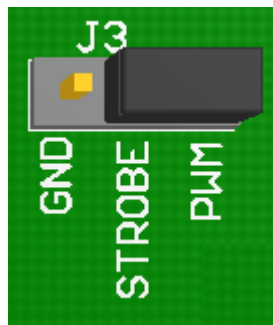

Figure 1. STROBE Jumper Settings

GND (Jumpers J5, J6, and J7) – These are additional pins to connect to ground (GND).

VLED, D1A (Jumper J8) – Connect VLED (J8<1>) and D1A (J8<2>) to light the LED as it connects the LED output of the driver to the on-board anode of the flash LED.

VIO (Jumper J9) – This pin can be used to measure the VIO.

3.3V, VIO, VIN (Jumper J10) – This jumper provides pullup for the I²C lines (clock and data). VIO (J10<2>) can be connected to the 3.3-V pin J10<1>) of the TI LaunchPad™. Communication via the I²C interface may not be possible if the supply voltage to the LED driver is below approximately 3 V.

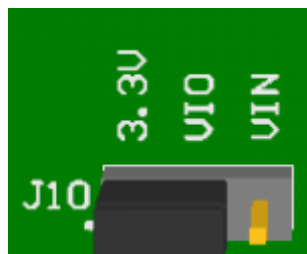

Figure 2. VIO Jumper Setting

LED Current Measurements, D1F, D1S, GNDS (Jumper J11) – The LM36011EVM provides a way to accurately measure the LED current through the LED on board. Resistor R3 (0.1 Ω) is placed between the cathode of LED (D1F) and ground. The user can first measure the resistor value accurately by first applying a known current through force pin (D1F) and ground and measuring the voltage between sense pin (D1S) and GNDS. Then, during normal flash or torch operation, the voltage measured across the resistor divided by the resistor value will equal the current through the resistor (or the LED).

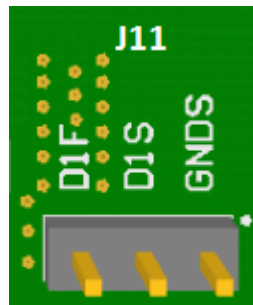

Figure 3. LED Current Measurements Jumper

SDA / SDK (Pins 9 and 10 on Launchpad) – These connections allow the user to externally control the I²C lines.

1.2 EVM Configuration

Configuration of LM36011EVM jumpers is as shown in Figure 4.

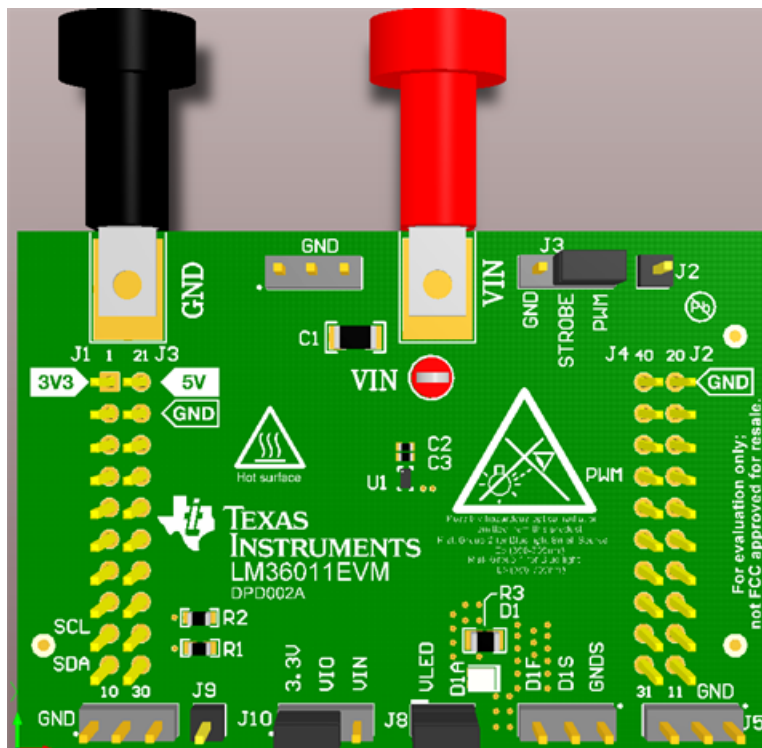

Figure 4. LM36011EVM Jumper Configuration

The input voltage range for the flash driver is 2.5 V to 5.5 V. The on-board LED or an LED module should be connected for proper operation.

The LM36011EVM dissipates power, especially during high current and long duration flash events. Power will also be dissipated on the flash LEDs. TI recommends that in order to prevent overheating, repeated flash events in very short time intervals is avoided. Special care must be taken with regards to thermal management when using time-out values greater than 500 ms.

The EVM layout is designed to minimize temperature rise during operation. Depending on the PCB layout, input voltage, and output current, it is possible to have the internal thermal shutdown circuit trip prior to reaching the desired flash time-out value. A warning is also placed on the EVM as a safety measure.

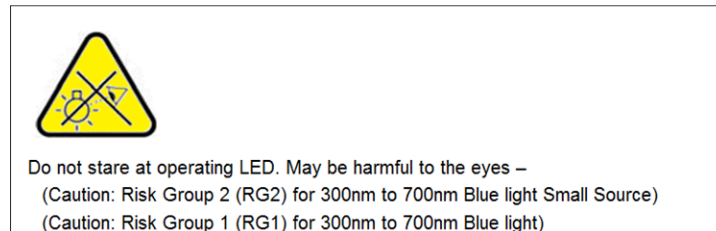

Figure 5. LED Warning

For proper operation of the LM36011EVM, the jumpers should be properly configured. The recommended setting using shorting blocks is:

- VIO (J10<2>) to 3.3 V (J10<1>) if TI Launchpad is used
- STROBE (J3<2>) to PWM (J3<1>) or external signal
- VLED (J8<1>) to D1A (J8<2>)

Texas Instruments has created LaunchPad (MSP432) and an I²C-compatible graphical user interface (GUI) that can help exercise the part in a simple way. A description of how to install and use the LaunchPad and the GUI is contained in [Section 2](#) and [Section 3](#).

The LM36011EVM has the means to “plug into” the LaunchPad BoosterPack connectors, which provide the control signals for the simple interface. Power to the part needs to be provided externally. A USB cable provided in LaunchPad MSP432 kit should be connected to the LaunchPad board from a PC as shown in [Figure 6](#).



Figure 6. LM36011EVM Test Setup

2 Software

2.1 Setup Overview

1. Verify jumper configuration on the MSP-EXP432P401R LaunchPad and the LM36011EVM as in [Figure 7](#) and [Figure 4](#), respectively.
2. Connect the LM36011EVM to the MSP-EXP432P401R LaunchPad.
3. If using the MSP432 for the first time, install XDS110 drivers as in [Section 2.2](#).
4. If the LM3601x GUI is not installed, refer to section [Section 2.3](#).
5. Run the EVM software and select LM36011 button in the EVM selection pop-up window.
6. If the LaunchPad is new or was used for another purpose, EVM software asks to update firmware, which can be done by clicking "FW Update" in the File menu on the top. EVM software restarts after updating firmware.
7. For LM36011EVM operation with the GUI, refer to [Section 3](#).

2.2 MSP432 LaunchPad Installation

Configuration of MSP432 LaunchPad jumpers is as shown in [Figure 7](#).

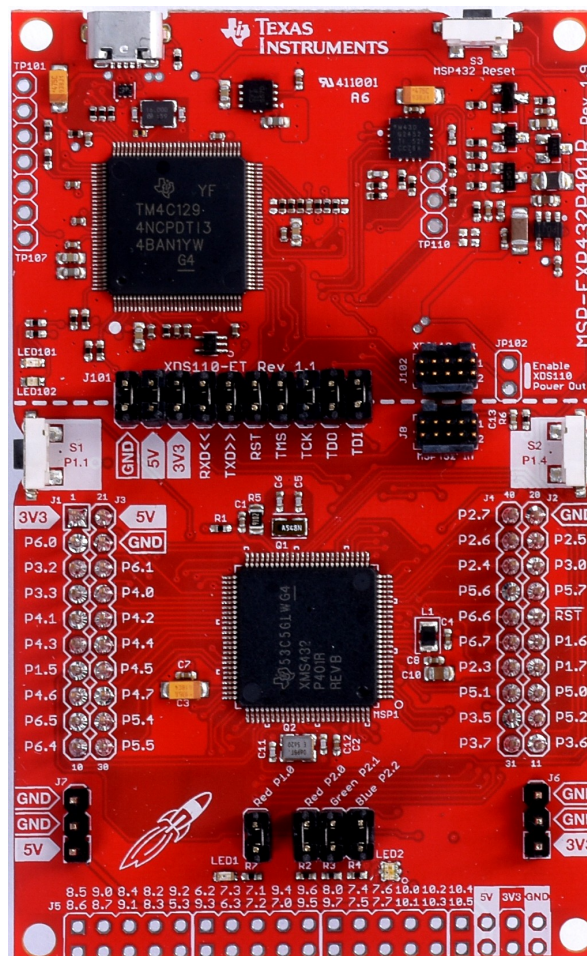

Figure 7. MSP432 LaunchPad Jumper Configuration

Driver XDS110 of the MSP432 LaunchPad must be installed to use the Texas Instruments LM36011 GUI. Go to [XDS Emulation Software Package](#) to download the driver. On the driver download website, click “3 XDS110 Reset Download” under Contents.

XDS Emulation Software Package

Contents [hide]	
1	Overview
2	XDS Emulation Software (emupack) Download
3	XDS110 Reset Download
4	Manual CCS Installation
5	Installation Independent of CCS
6	Questions

Figure 8. Driver Download Website (Part 1)

There are several versions to install depending on the computer’s operating system. Choose the appropriate version for the computer.

XDS110 Reset Download

The XDS110 Reset utility provides board level reset (via nSRST pin) for the XDS110 debug probe. The software support is available for Windows XP, Windows 7, Linux (Ubuntu 12.04 & SUSE 11), and Mac OS X.

Release	Date	Release Notes	Download
6.0.228.0	April 29, 2016	<p>Delta from last release:</p> <ul style="list-style-type: none"> - Various bug fixes and enhancements for XDS110 emulator. 	Windows Linux 32-bit Linux 64-bit Mac OS X

Figure 9. Driver Download Website (Part 2)

Fill out the form for U.S government export approval.

U.S. Government export approval:

All fields are Required. Incomplete information will be DENIED.

First name:

Last name:

Your email address:

Your full company/university name:

Country this file will be used in:

What end-equipment/application will you use this file for:

Military

Civil

Figure 10. U.S. Government Export Approval (Part 1)

At the end of the form, check “Yes” next to the statement “I CERTIFY ALL THE ABOVE IS TRUE”. Then, click “Submit”.

I certify that the following is true:

(a) I understand that this Software/Tool/Document is subject to export controls under the U.S. Commerce Department's Export Administration Regulations (“EAR”).

(b) I am NOT located in Cuba, Iran, North Korea, Sudan or Syria. I understand these are prohibited destination countries under the EAR or U.S. sanctions regulations.

(c) I am NOT listed on the Commerce Department's Denied Persons List, the Commerce Department's Entity List, the Commerce Department's General Order No. 3 (in Supp. 1 to EAR Part 736), or the Treasury Department's Lists of Specially Designated Nationals.

(d) I WILL NOT EXPORT, re-EXPORT or TRANSFER this Software/Tool/Document to any prohibited destination, entity, or individual without the necessary export license(s) or authorization(s) from the U.S. Government.

(e) I will NOT USE or TRANSFER this Software/Tool/Document for use in any sensitive NUCLEAR, CHEMICAL or BIOLOGICAL WEAPONS, or MISSILE TECHNOLOGY end-uses unless authorized by the U.S. Government by regulation or specific license.

(f) I understand that countries other than the United States may restrict the import, use, or export of the Subject Product. I agree that we shall be solely responsible for compliance with any such import, use, or export restrictions.

- I / We hereby certify that we will adhere to the conditions above.
- I / We do not know of any additional facts different from the above.
- I / We take responsibility to comply with these terms.
- I / We understand we are responsible to abide by the most current, versions of the Export Administration Regulations and other U.S. export and sanctions laws.

I CERTIFY ALL THE ABOVE IS TRUE: Yes No

Submit

Thank you,
Texas Instruments

Figure 11. U.S. Government Export Approval (Part 2)

If everything is filled out properly, the user can gain access to the file. The zip file can be downloaded by clicking on “Download” or by going to the user’s email.

TI Request

**You have been approved to receive this file.
Click "Download" to proceed.**

In a few moments, you will also receive an email with the link to this file.

Download
Having trouble downloading? Try www.ti.com/software-help

Thank you,
Texas Instruments

Figure 12. Driver Download (Part 1)

Save the driver zip file to any folder on the computer.

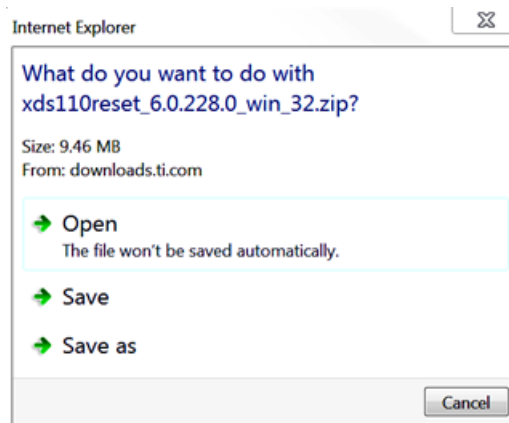

Figure 13. Driver Download (Part 2)

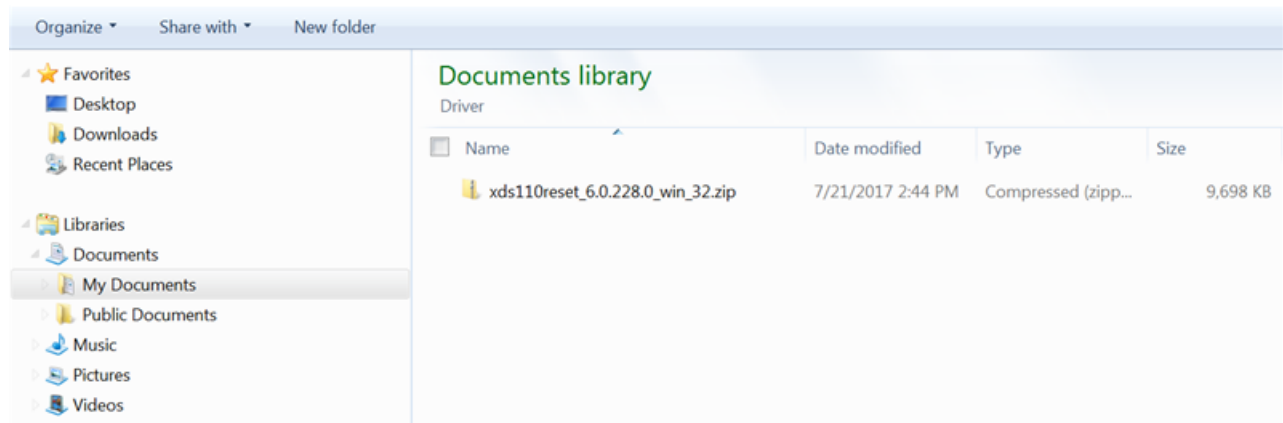

Figure 14. Driver Zip Folder

The zip file can then be extracted to any folder.

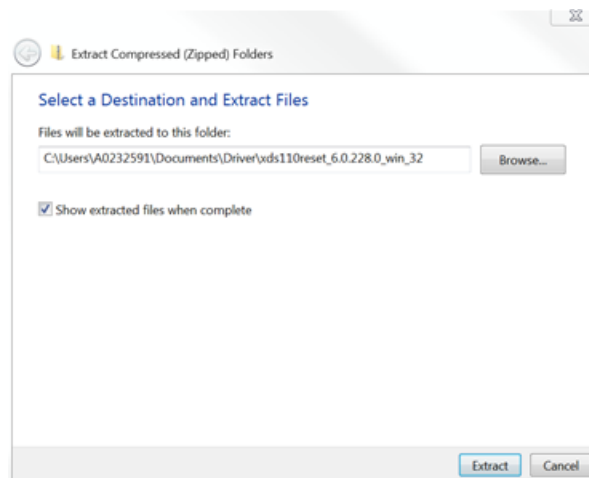

Figure 15. Extract Files

Click the folder to access the driver installation. In the folder, click “xdsdrivers-1.7.0.0-windows-installer.exe”.

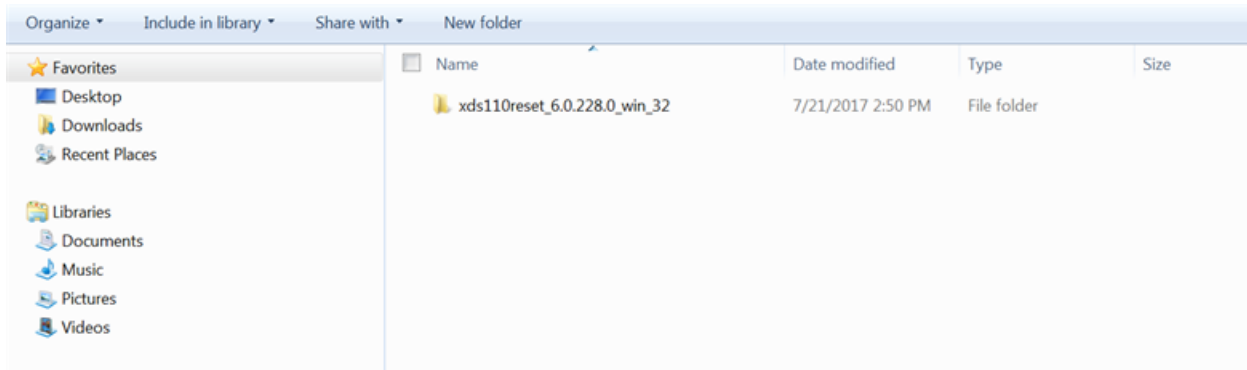

Figure 16. Driver Folder

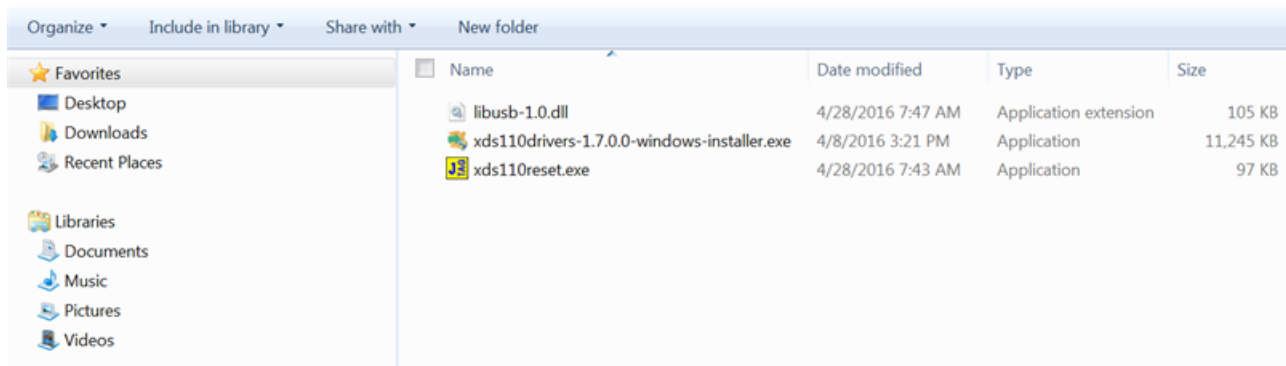

Figure 17. Driver Folder (Inside)

Once the driver setup is selected, a window appears as shown below. Click “Next” to proceed.

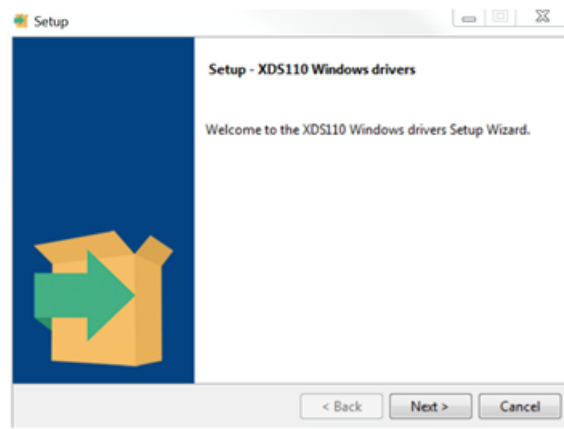

Figure 18. Driver Setup

Check “I accept the agreement” and click “Next” to proceed.



Figure 19. Driver License Agreement

A default installation directory is already filled in the box, but it can be changed to the user's preferred location. When ready, click "Next".

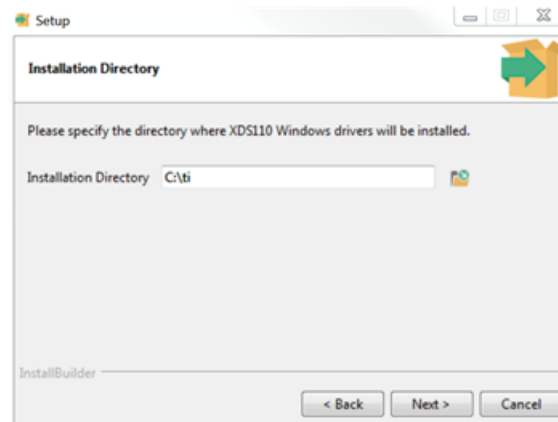

Figure 20. Driver Installation Directory

Click "Next" again to begin the installation. However, a series of security windows appears to confirm the installation. Click "Install" for each window.

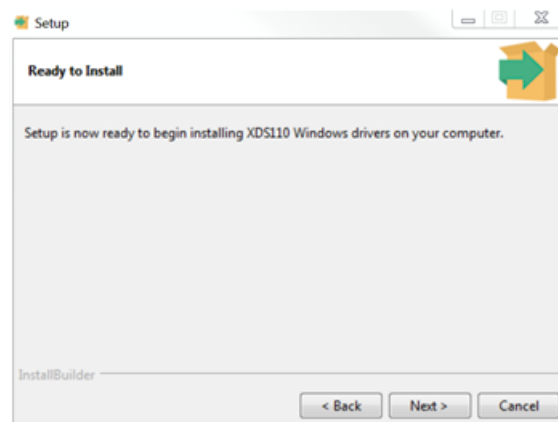

Figure 21. Device Driver Installation (Part 1)

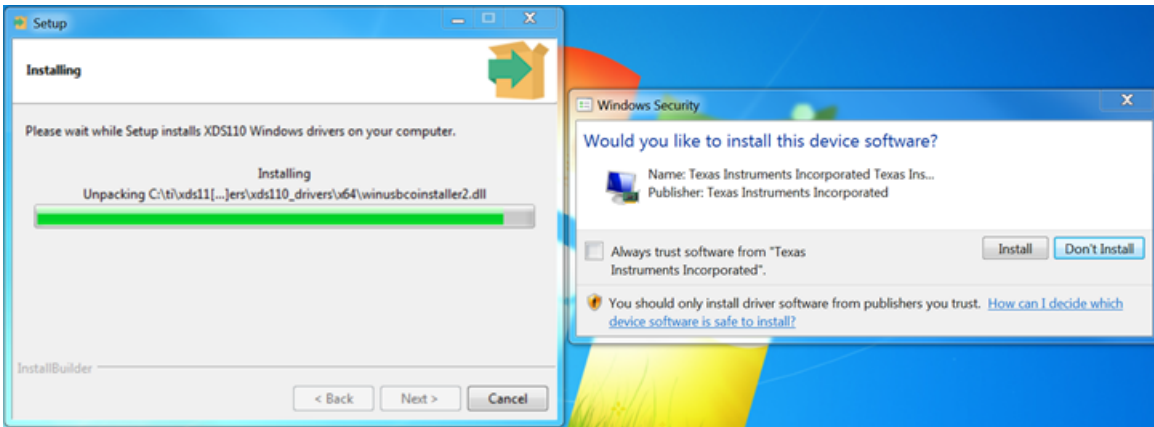

Figure 22. Device Driver Installation (Part 2)

In the end, a final window shows that the installation has completed. Click “Finish” to complete the installation process.

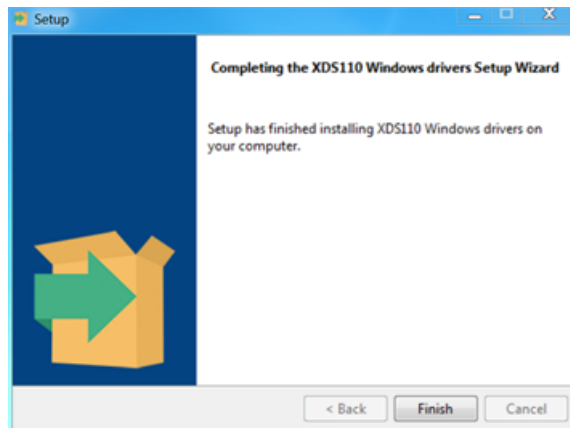

Figure 23. Device Driver Installation (Part 3)

2.3 EVM GUI Installation

LM36011 GUI is available to download from the TI website: [LM3601xEVM GUI](#).

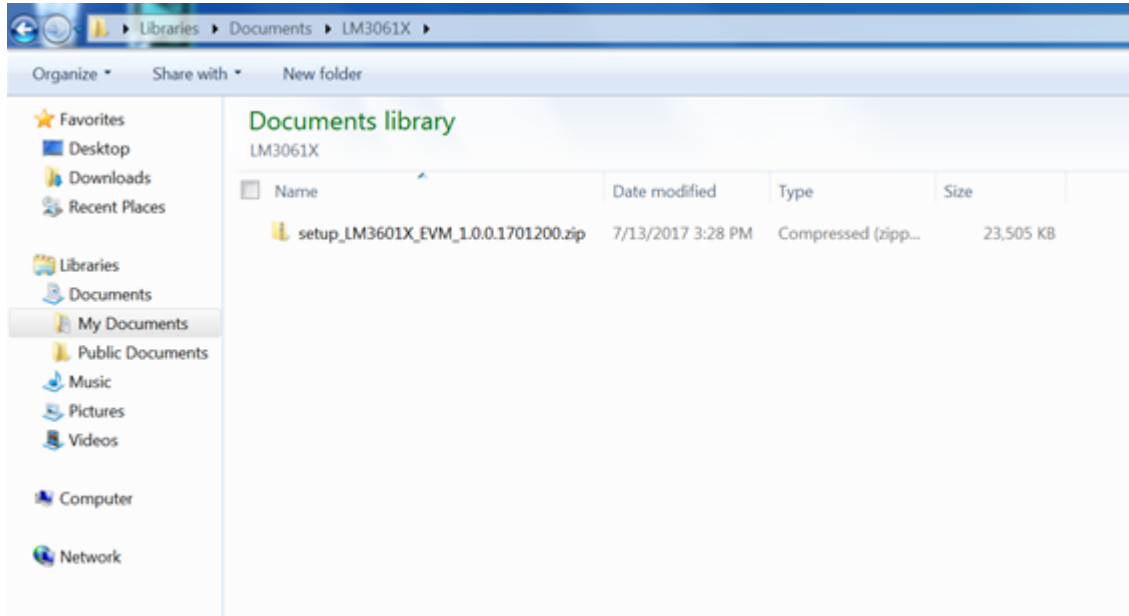

Figure 24. EVM Software Zip File

The zip file to install the GUI can be downloaded into any folder.

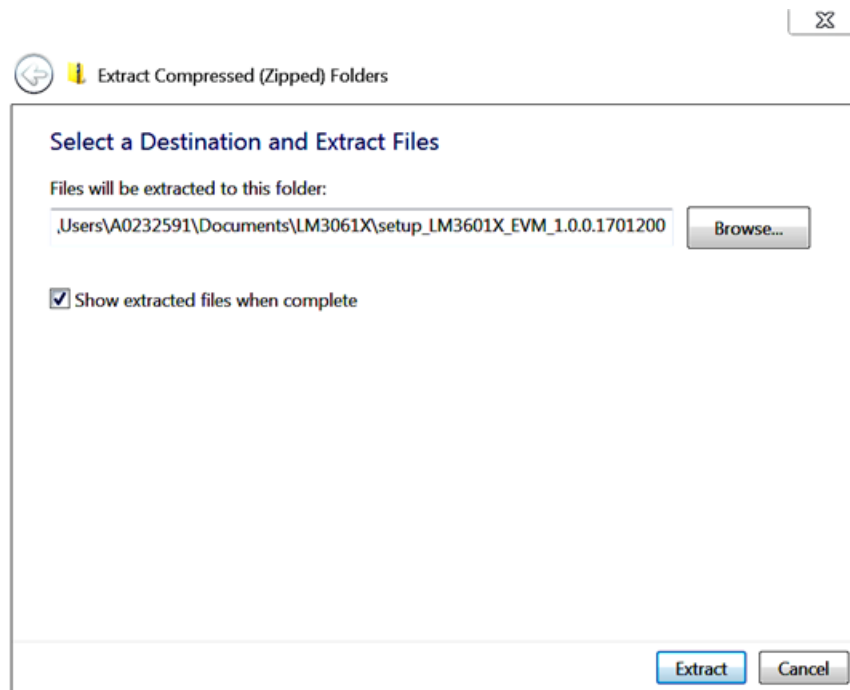

Figure 25. EVM Software Extract Files

Click the extracted file to access the EVM software installation. If there are any security programs, allow the file to be added to the computer.

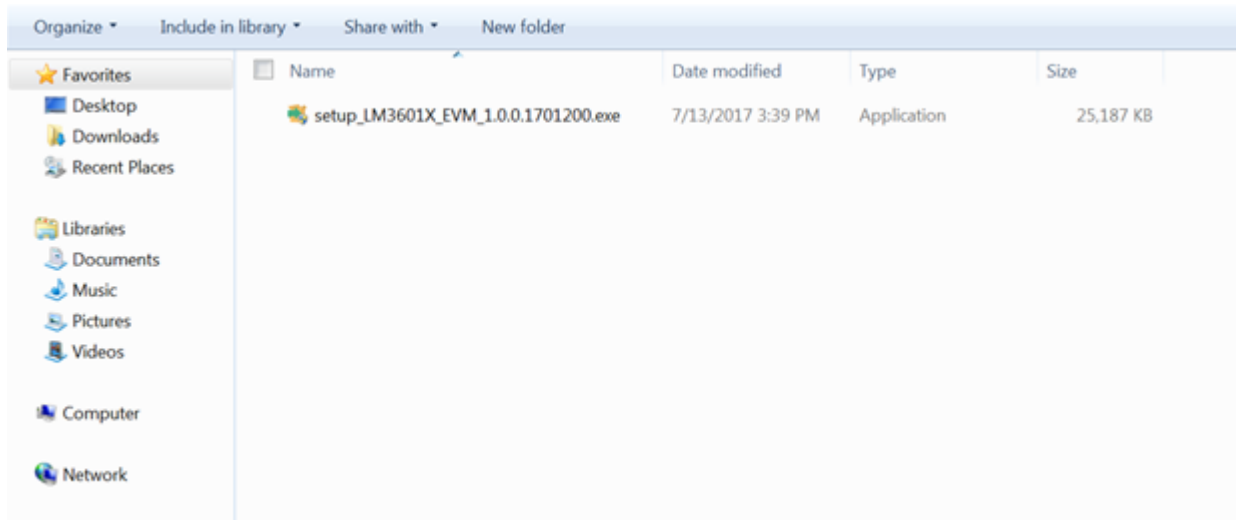

Figure 26. EVM Software Setup File

Once the file has been clicked, a window opens to install the EVM software. Click "Next" to proceed. Though the setup wizard says "Setup - LM36010 EVM" in some of the installation steps, the installed GUI has the capability to work with LM36011EVM.

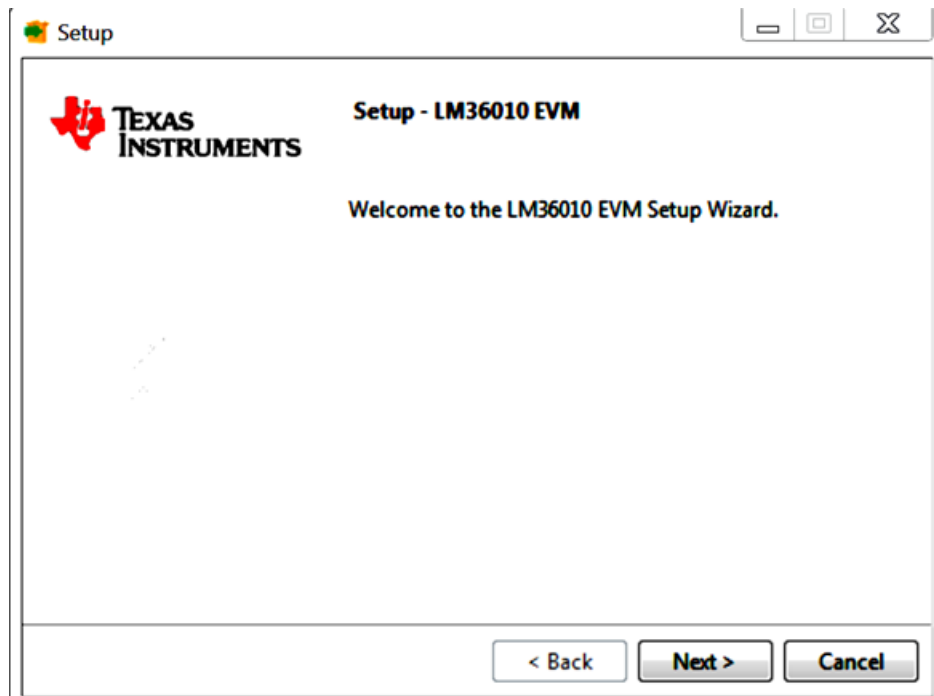

Figure 27. EVM Software Setup Wizard

Check “I accept the agreement” and click “Next” to proceed.

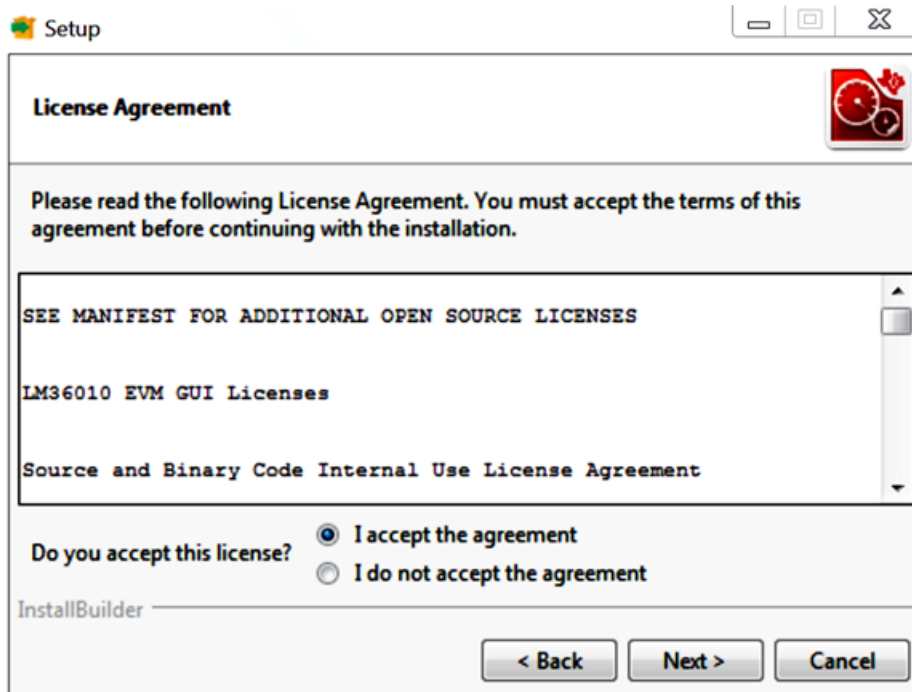

Figure 28. EVM Software License Agreement

A default installation directory is already filled in the box, but it can be changed to the user's preferred location. When ready, click “Next”.

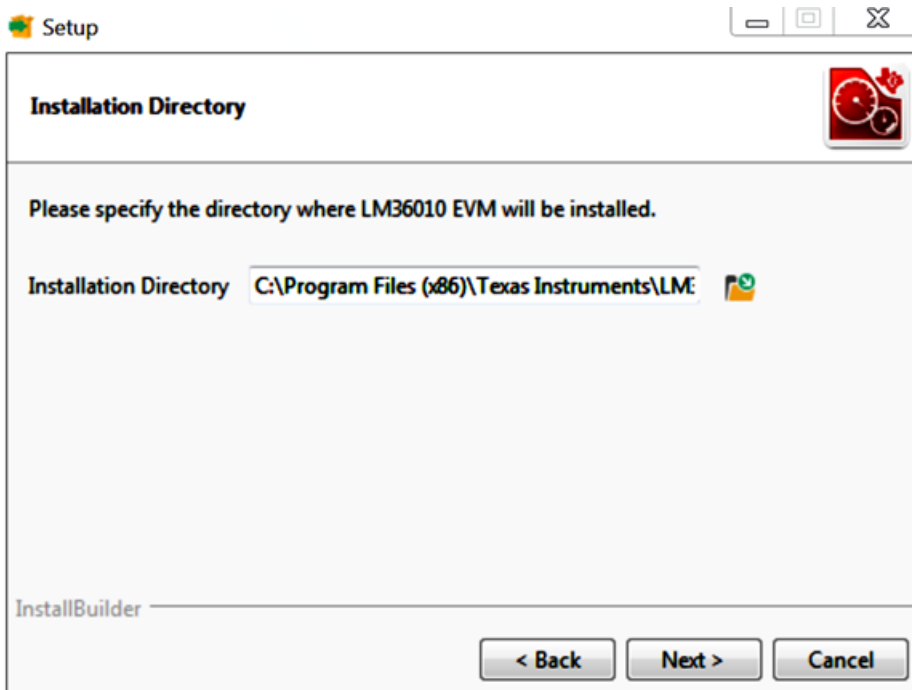

Figure 29. EVM Software Installation Directory

Click “Next” again to begin the installation. The window then shows the progress of the installation.

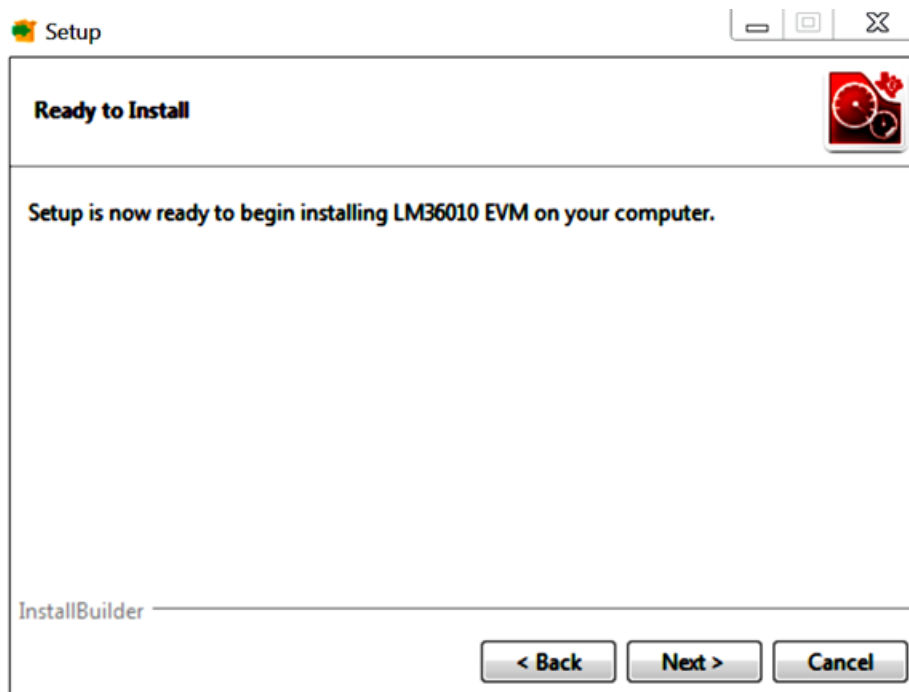

Figure 30. EVM Software Installation (Part 1)

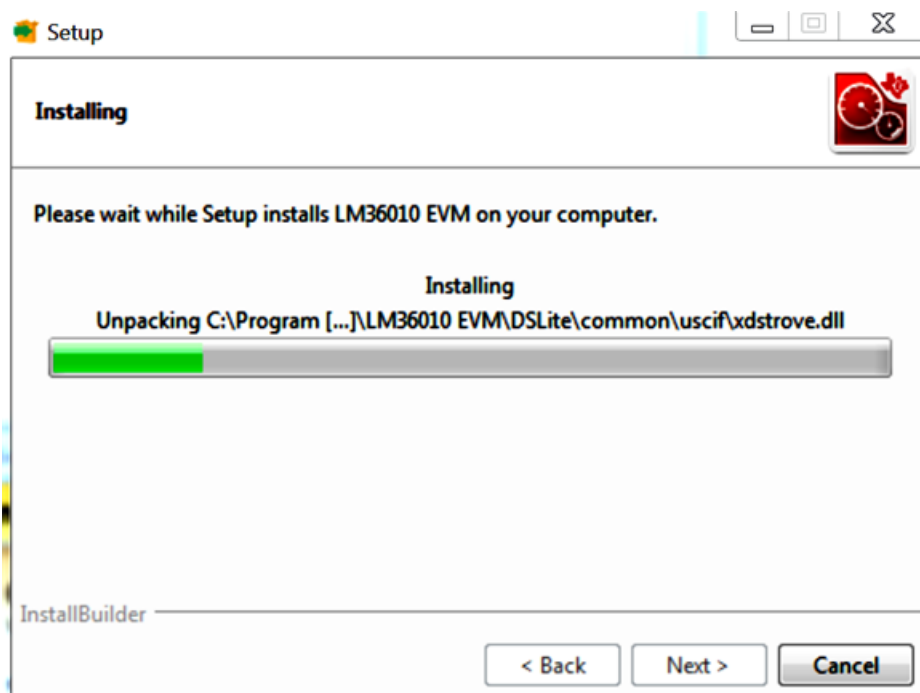

Figure 31. EVM Software Installation (Part 2)

After the installation is finished, the user has the option to open the program and create a shortcut on the Desktop. This step is optional. Click “Finish” to complete the installation process.

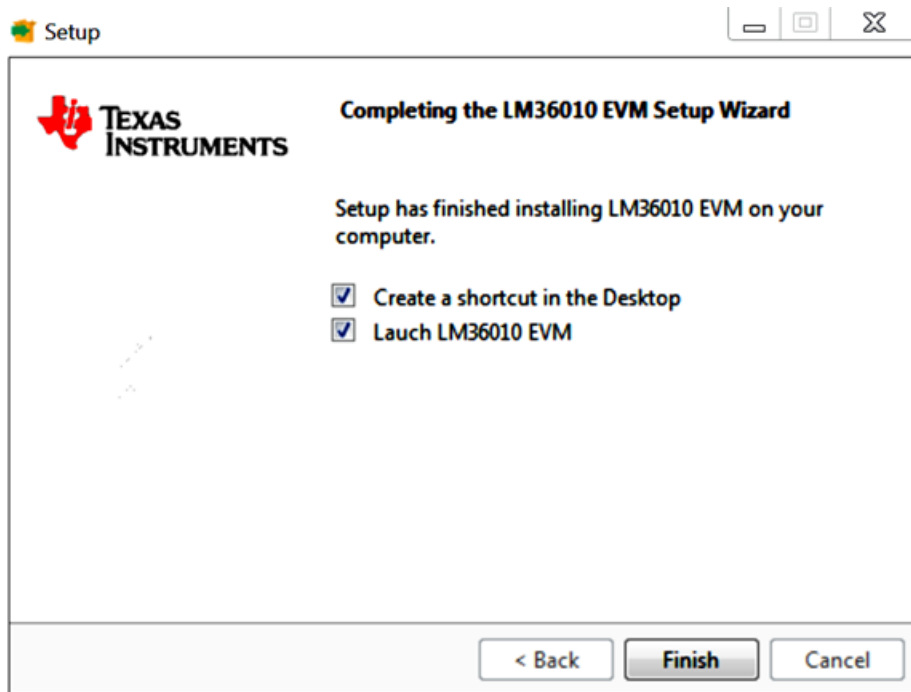

Figure 32. EVM Software Installation (Part 3)

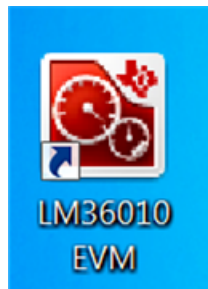

Figure 33. EVM Software Desktop Shortcut

3 GUI Operation

For proper operation, plug in the LM36011EVM and the LaunchPad to the computer before the GUI is opened. Once connected, and the program is executed, an EVM selection screen opens. Clicking on LM36011EVM leads to the appropriate GUI.

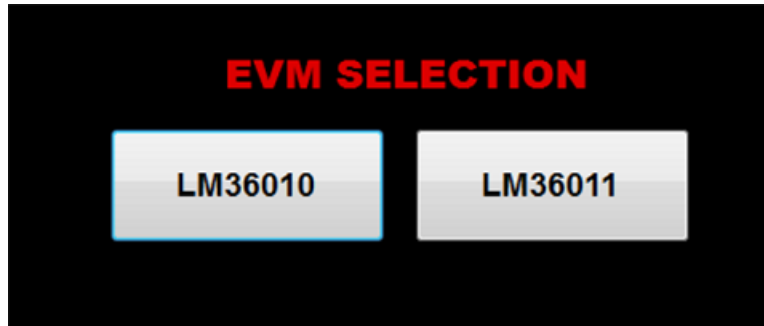

Figure 34. LM3601X Selection

A basic interface window opens with the default information view (Info). The status bar at the bottom of EVM software screen provides information regarding hardware connection status, I²C communication status, and software version. Once the EVM software is connected to the hardware and starts to communicate with the firmware of MSP432, “Hardware Connected” and the light blue sign is displayed.

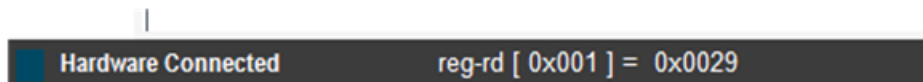

Figure 35. Status Bar

There are three available views of main menu: “Info”, “Register”, and “Control”. The components in each view are synchronized, so any changes performed in one view of menu are automatically updated in the others.



Figure 36. Menu

3.1 Information View

The Information View provides brief information of the LM36011EVM. For more detailed information, refer to the [LM36011 data sheet](#).

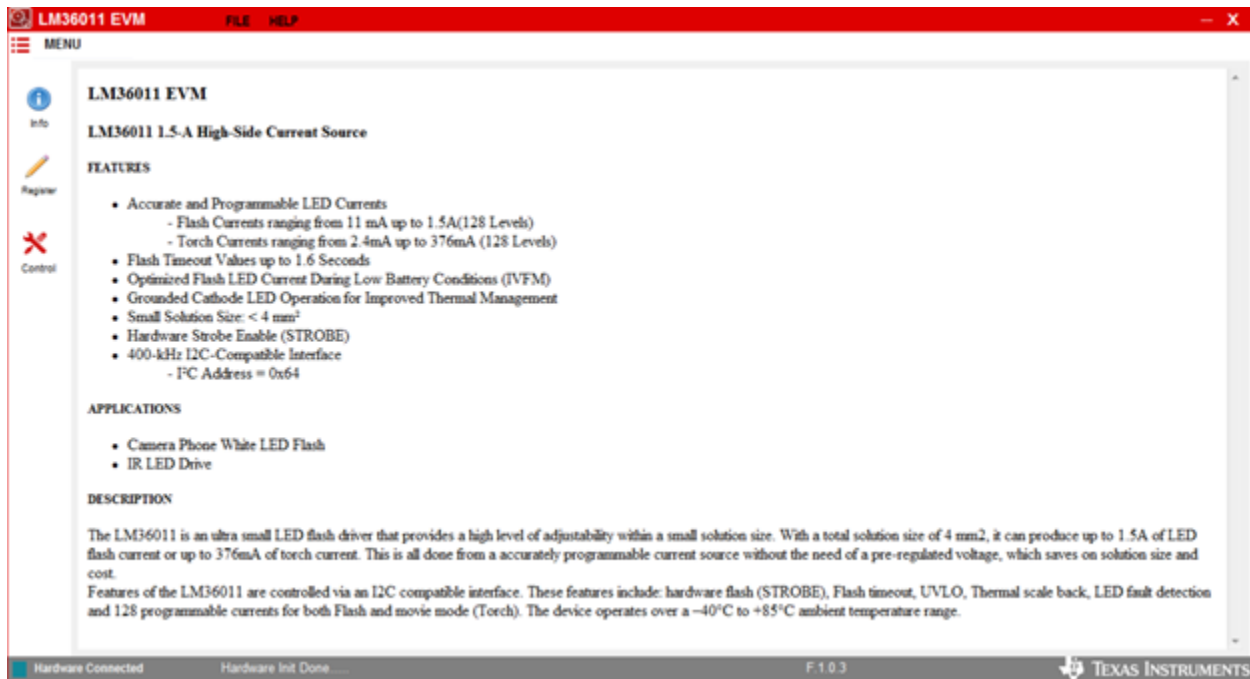

Figure 37. LM36011EVM Information View

3.2 Register View

The register view is shown when “Register” icon is clicked, and it provides the Register values, FieldView and Description fields. The user can enter the desired hex value to the registers in the “Value” column of Register values or in the “Value” column of FieldView, or can also perform a bit-wise configuration of any register fields by double-clicking on the corresponding register bit. “FieldView” displays the description of all fields of the selected register. Each register can be read independently or all registers can be read at once by utilizing the “Read” and “Read All” buttons, respectively.

The data is written to the register(s) in one of two ways, depending on the “Update Mode” field selection. In “Immediate” mode, the register data is written immediately following a “Value”, an individual bit, or a “Value” change. In “Deferred” mode, the displayed data is written to all registers upon depression of the “Write” button. The “Read All” button can be pressed to read back all the registers, which updates the values on the table.

Register settings can be saved to text file format by selecting “Save Registers” from file menu. Text file format register settings file can be loaded and programmed automatically by selecting “Load Register” from file menu.

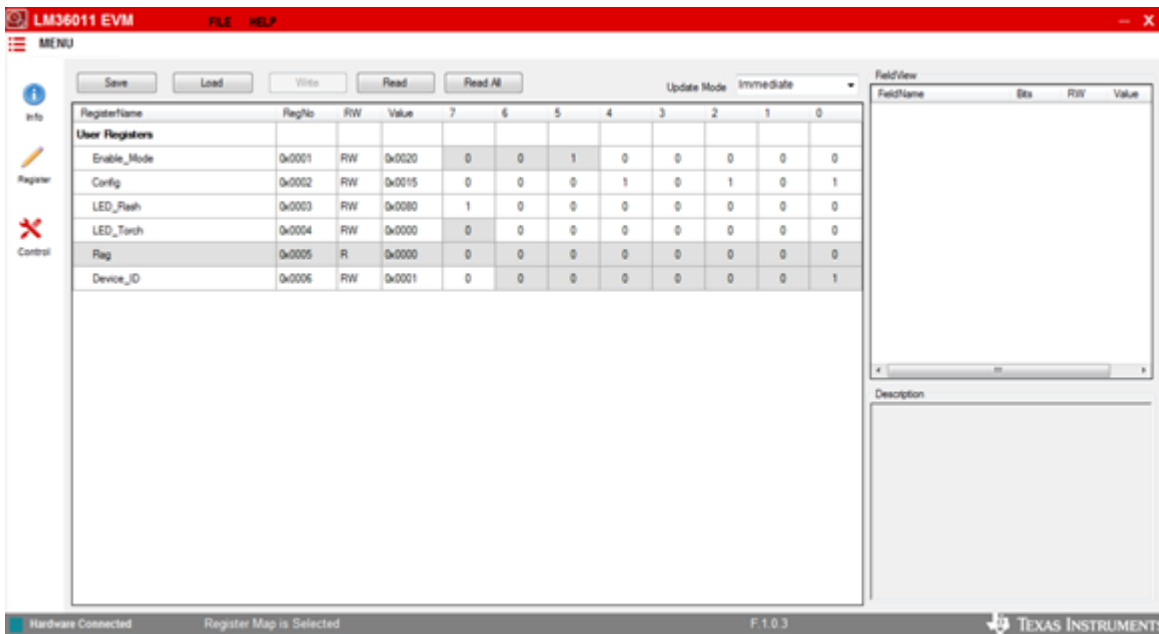

Figure 38. LM36011EVM Register View

3.3 Control View

The LM36011EVM GUI provides the user with access to all of the registers found on the device. The user can control these registers by clicking on “Control” on the left sidebar menu. Through a combination of buttons, drop-down boxes and sliders, the user can configure the LM36011EVM to perform in the desired mode. Unlike the Register View, the Control View only provides "Immediate" mode.

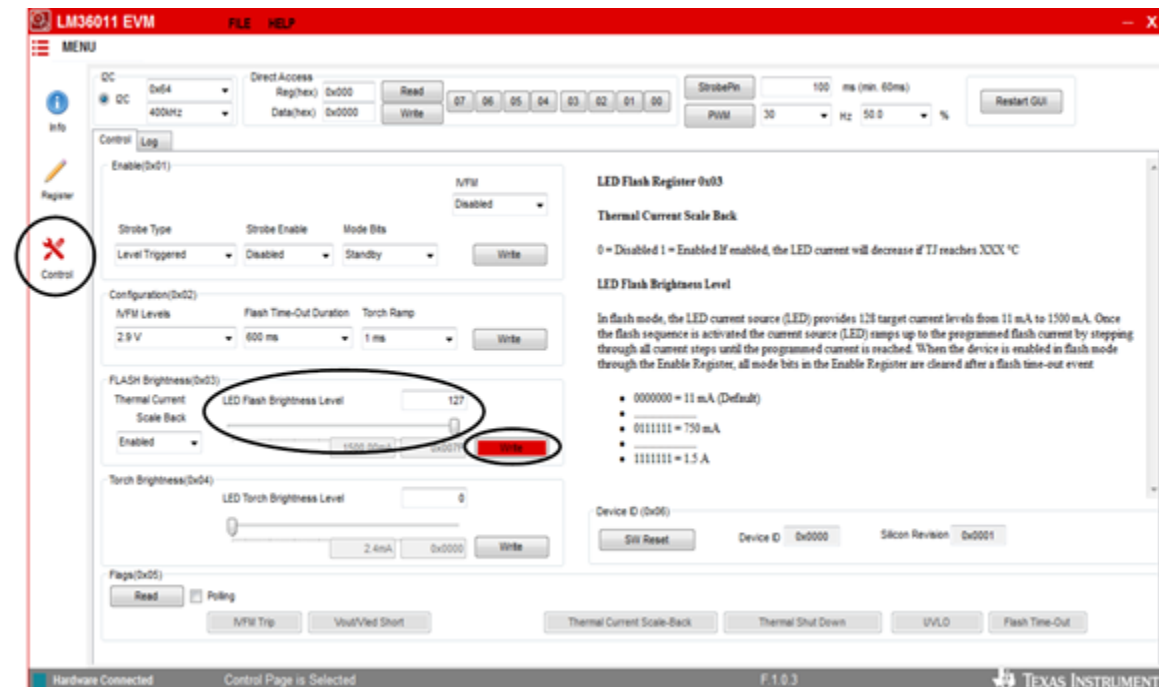

Figure 39. LM36011EVM Control View

3.3.1 I2C Interface Fields

The I²C Interface fields can be used to write or read any LM36011EVM register.



Figure 40. I2C Interface Fields

3.3.2 Control Panel

The Control Panel provides easy ways to control registers and pin values. There are two tabs available in the Control Panel: "Control" and "Log". The left side of these tabs contains the controls for the corresponding block of the LM36011EVM. The right side contains data log information.

The LM36011EVM has two main modes for testing: **Flash** and **Torch**. Both of them can be controlled on the Control Panel.

To produce a flash from the LED, the user can select **Flash** mode in the "Mode Bits" Options. Under "Configuration (0x02)", the flash duration can be changed. Under "FLASH Brightness (0x03)", the LED flash brightness level can either be adjusted with the scale or be written in the field provided. The max brightness code is 127, corresponding to 1.5 A. Once the settings are adjusted, the user can press the "Write" button to see the flash. Note that the LM36011EVM automatically switches to **Stand-by** mode after the **Flash** event.

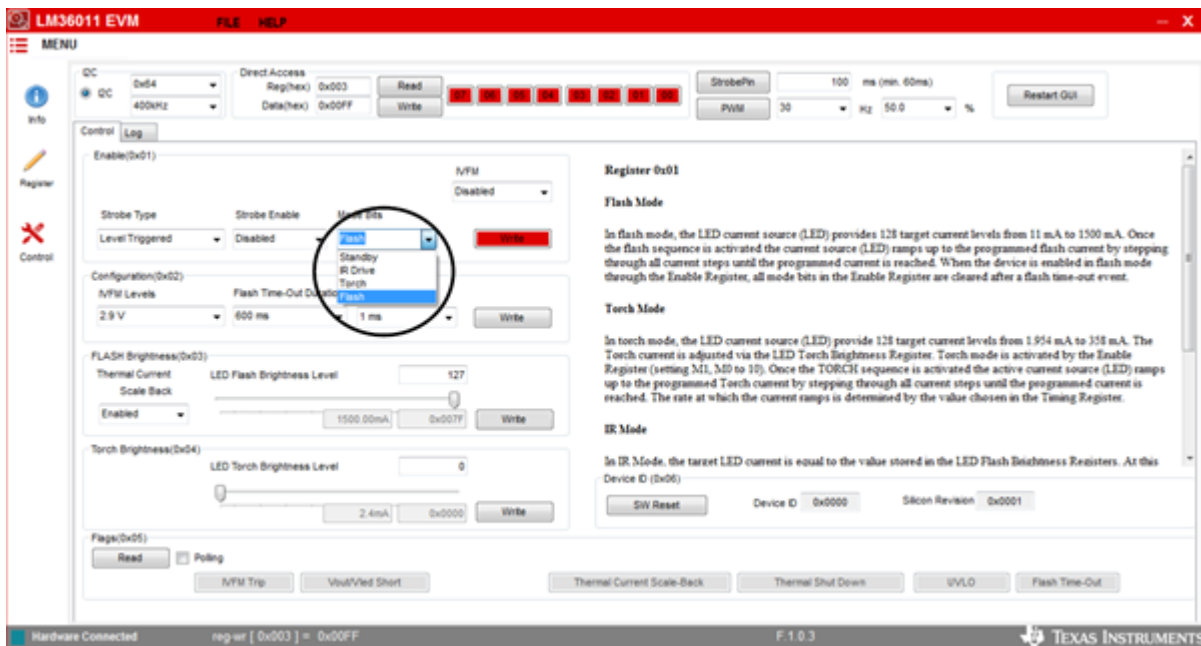

Figure 41. Flash Settings

To produce torch from the LED, the user can select **Torch** mode in the "Mode Bits" Options. Under "Torch Brightness (0x04)", the LED torch brightness level can be adjusted either with the scale or be written in the field provided. The maximum brightness code is 127. Once the settings are adjusted, the user can press the "Write" button to see the torch. LM36011EVM remains in **Torch** mode until it is switched to another mode.

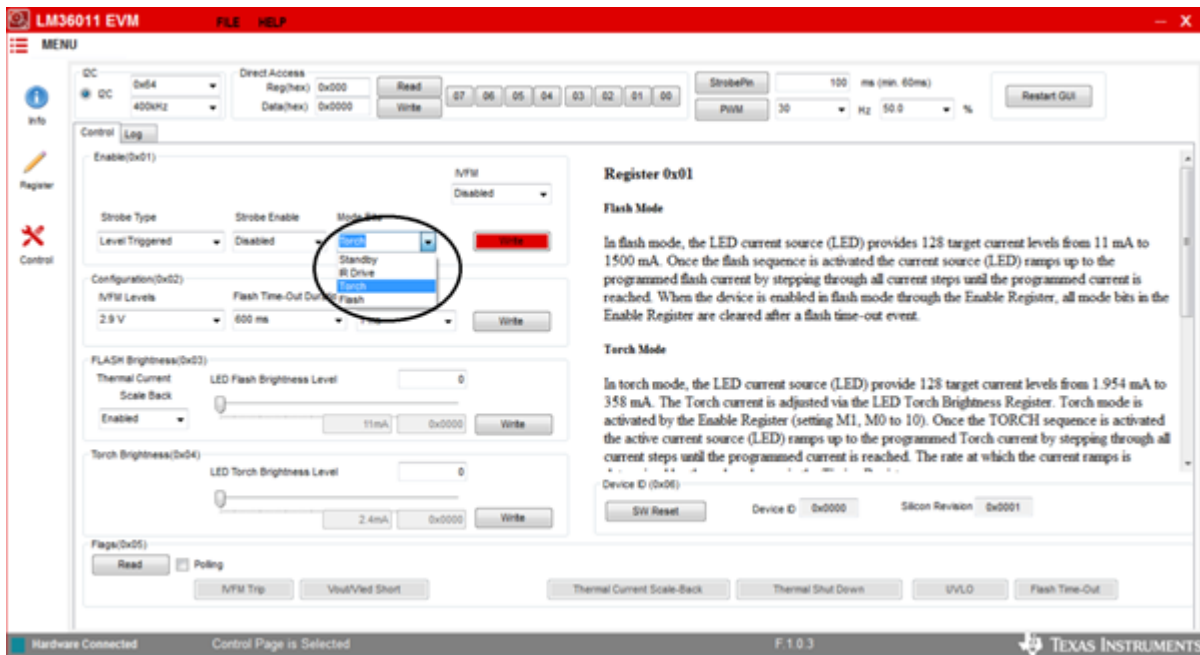

Figure 42. Torch Settings

Note that no data is written to the device until the “Write” button found within the corresponding register is pressed.

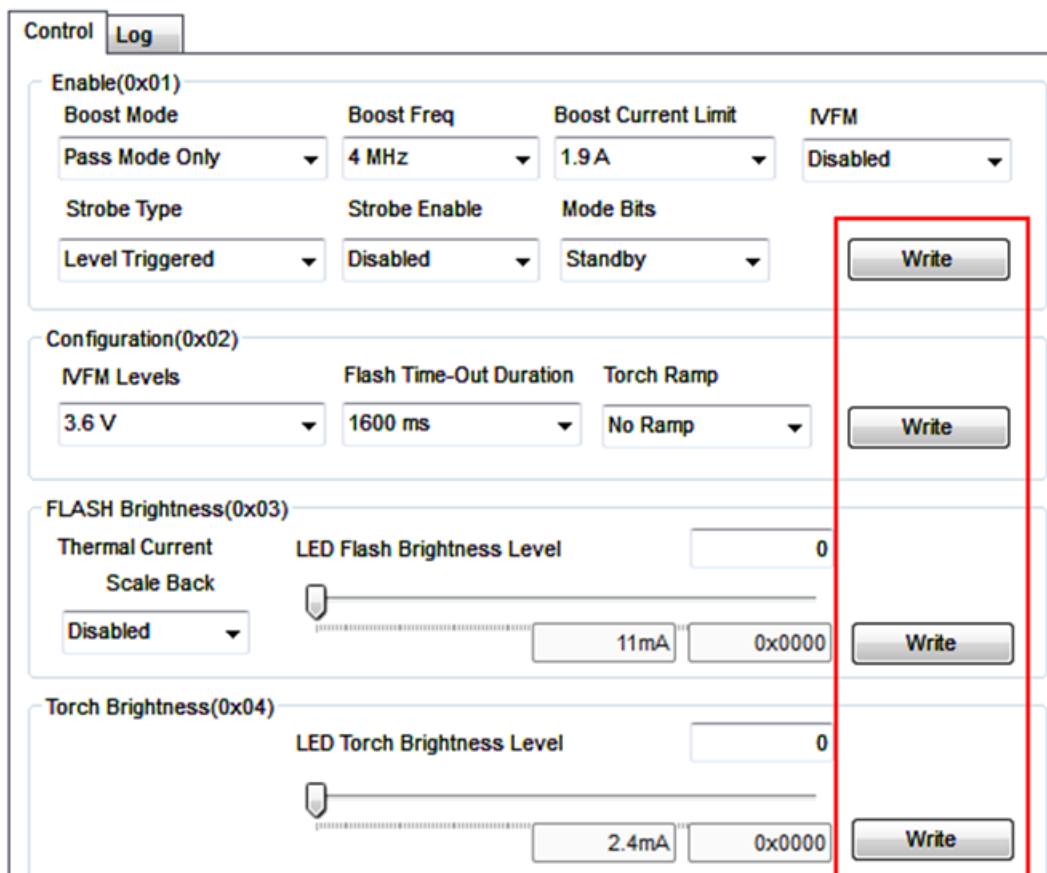

Figure 43. Write Buttons

3.3.3 Flags

The contents of the LM36011 fault registers are read upon clicking the “Read Flags” button. The registers are cleared upon read back.

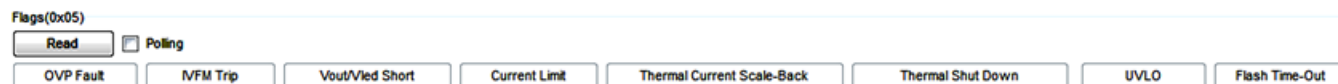

Figure 44. Flags

3.3.4 I/O Pin Controls

The LM36011 provides the user with the capability to control the STROBE input without the need of an external supply. The "StrobePin" button toggles the STROBE pin high for the duration entered in the field next to the button. The "PWM" button along with the frequency and duty cycle fields generate a continuous pulse train that can be used to generate a current pulse pattern on the enabled LED.



Figure 45. I/O Pin Controls

4 Schematic

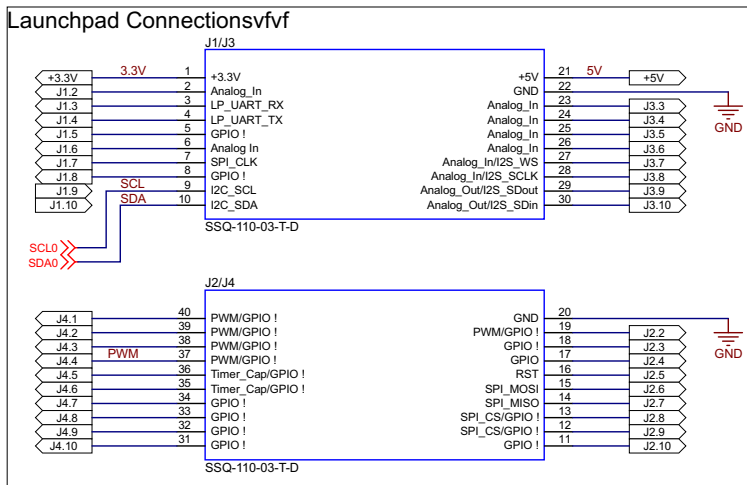
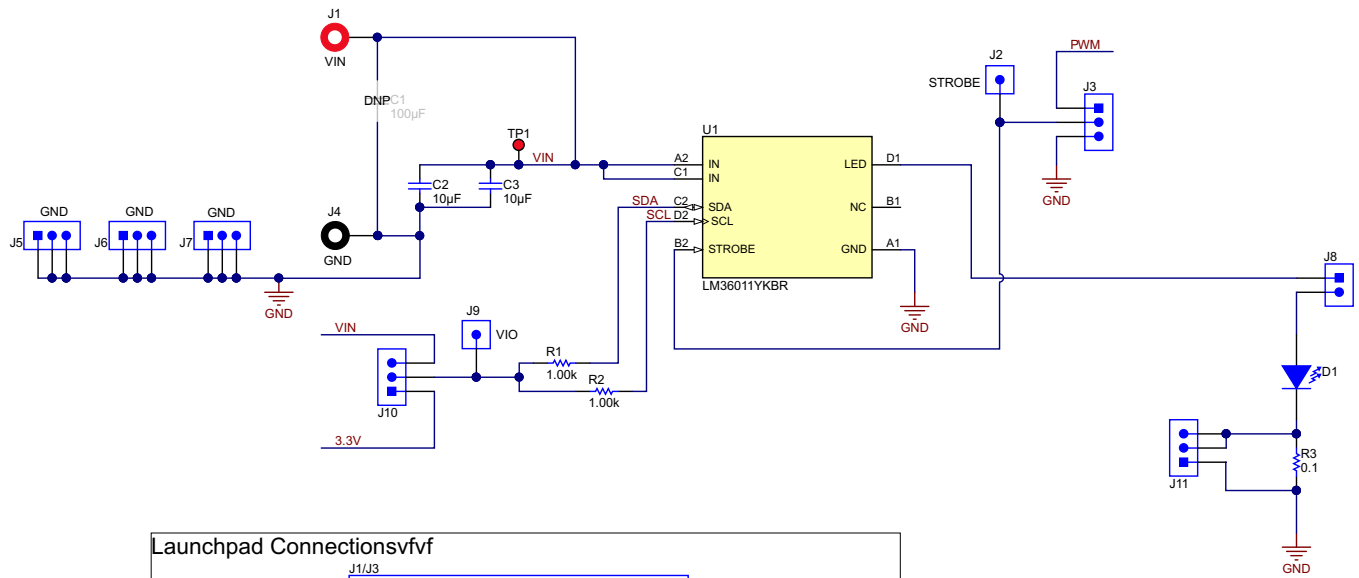

Copyright © 2017, Texas Instruments Incorporated

Figure 46. LM36011EVM Schematic

5 Board Layout

Figure 47, Figure 48, and Figure 49 show the board layout for the LM36011EVM. The EVM offers resistors, capacitors, and jumpers to enable the device and to configure it as desired.

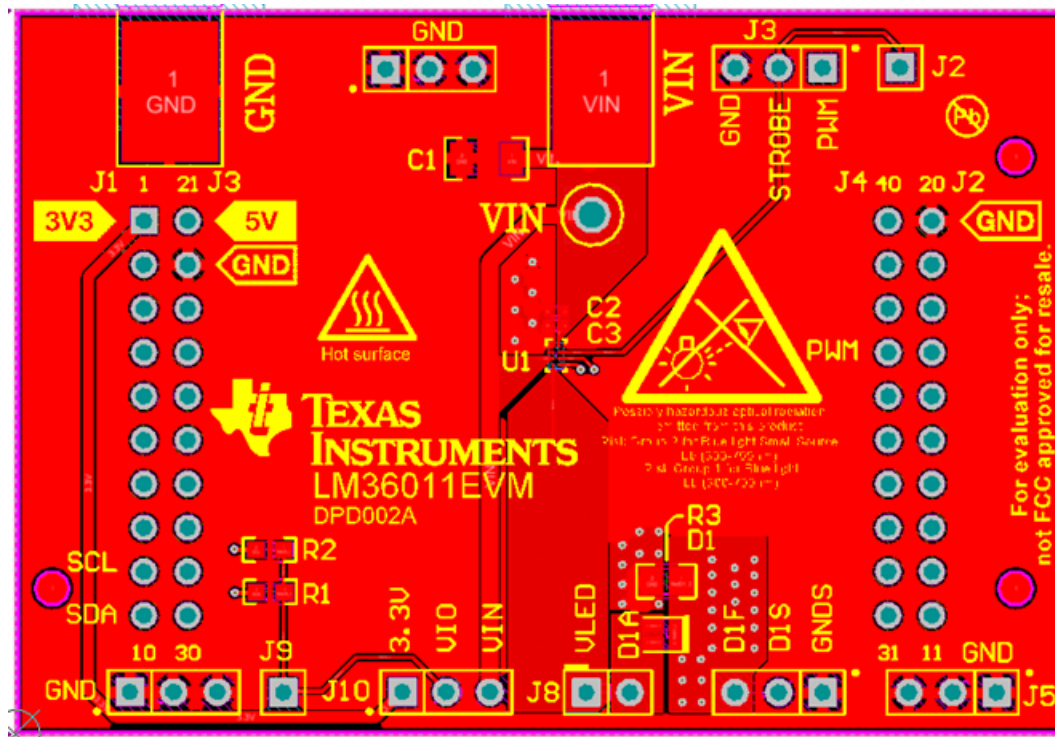

Figure 47. Top Assembly Layer

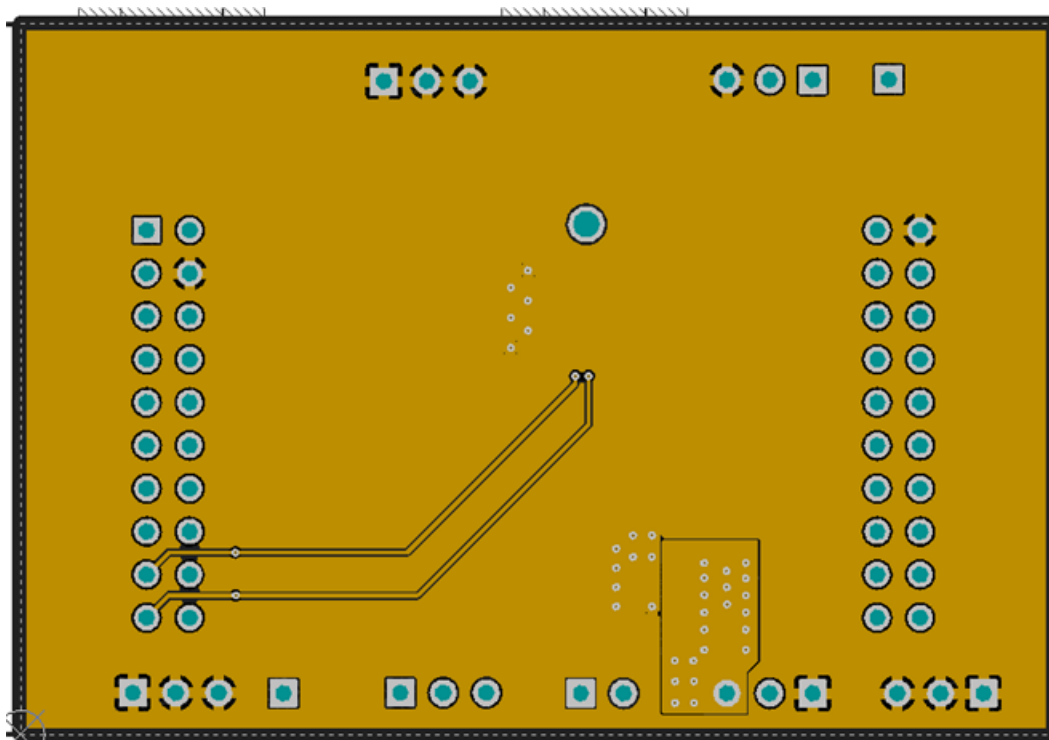

Figure 48. Middle Layer 1 Routing

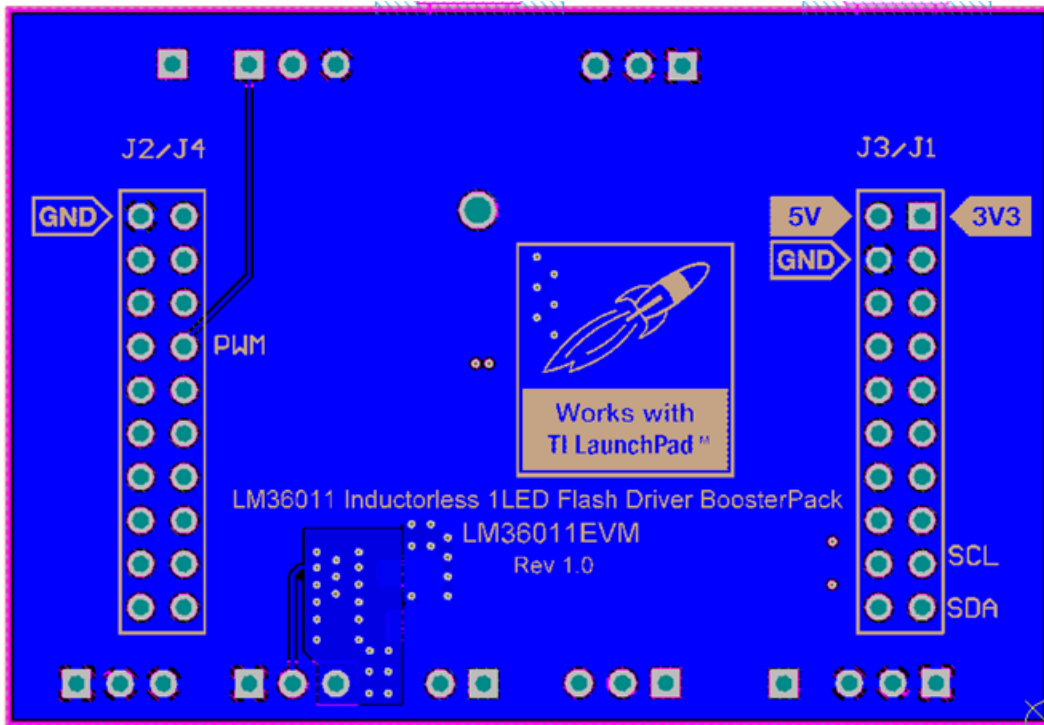

Figure 49. Bottom Assembly Layer (UNMIRRORED)

6 LM36011EVM Bill of Materials
Table 2. Bill of Materials

Designator	Qty.	Value	Description	Package Reference	Part Number	Manufacturer	Alternate Part Number	Alternate Manufacturer
!PCB1	1		Printed Circuit Board		DPD002	Any	-	-
C2, C3	2	10uF	CAP, CERM, 10uF, 6.3V, +/-20%, X5R, 0402	402	CL05A106MQ5NUNC	Samsung		
D1	1	Cool White	LED, Cool White, SMD	2.04x0.7x1.64 mm	LXCL-EYW4	Philips Lumileds		
J1	1		Standard Banana Jack, Insulated, Red	6091	6091	Keystone		
J1/J3, J2/J4	2		Receptacle, 2.54mm, 10x2, Tin, TH	10x2 Receptacle	SSQ-110-03-T-D	Samtec	CRD-081413-A-G	Major League Electronics
J2, J9	2		Header, 100mil, 1pos, Gold, TH	Testpoint	TSW-101-07-G-S	Samtec		
J3, J5, J6, J7, J10, J11	6		Header, 100mil, 3x1, Gold, TH	Header, 100mil, 3x1, TH	HTSW-103-07-G-S	Samtec		
J4	1		Standard Banana Jack, Insulated, Black	6092	6092	Keystone		
J8	1		Header, 100mil, 2x1, Gold, TH	2x1 Header	TSW-102-07-G-S	Samtec		
R1, R2	2	1.00k	RES, 1.00 k, 1%, 0.1 W, 0603	603	CRCW06031K00FKEA	Vishay-Dale		
R3	1	0.1	RES, 0.1 ohm, 5%, 0.125W, 0805	805	ERJ-6RSJR10V	Panasonic	-	-
SH-J1, SH-J2, SH-J3	3	1x2	Shunt, 100mil, Flash Gold, Black	Closed Top 100mil Shunt	SPC02SYAN	Sullins Connector Solutions		
TP1	1		Test Point, Compact, Red, TH	Red Compact Testpoint	5005	Keystone		
U1	1		Synchronous Boost LED Flash Driver with 1.5-A High-Side Current Source, YKB0008AGAG (DSBGA-8)	YKB0008AGAG	LM36011YKBR	Texas Instruments		Texas Instruments
C1	0	100uF	CAP, CERM, 100uF, 6.3V, +/-20%, X5R, 1206	1206	GRM31CR60J107ME39L	MuRata	-	-
FID1, FID2, FID3	0		Fiducial mark. There is nothing to buy or mount.	Fiducial	N/A	N/A		

IMPORTANT NOTICE FOR TI DESIGN INFORMATION AND RESOURCES

Texas Instruments Incorporated ("TI") technical, application or other design advice, services or information, including, but not limited to, reference designs and materials relating to evaluation modules, (collectively, "TI Resources") are intended to assist designers who are developing applications that incorporate TI products; by downloading, accessing or using any particular TI Resource in any way, you (individually or, if you are acting on behalf of a company, your company) agree to use it solely for this purpose and subject to the terms of this Notice.

TI's provision of TI Resources does not expand or otherwise alter TI's applicable published warranties or warranty disclaimers for TI products, and no additional obligations or liabilities arise from TI providing such TI Resources. TI reserves the right to make corrections, enhancements, improvements and other changes to its TI Resources.

You understand and agree that you remain responsible for using your independent analysis, evaluation and judgment in designing your applications and that you have full and exclusive responsibility to assure the safety of your applications and compliance of your applications (and of all TI products used in or for your applications) with all applicable regulations, laws and other applicable requirements. You represent that, with respect to your applications, you have all the necessary expertise to create and implement safeguards that (1) anticipate dangerous consequences of failures, (2) monitor failures and their consequences, and (3) lessen the likelihood of failures that might cause harm and take appropriate actions. You agree that prior to using or distributing any applications that include TI products, you will thoroughly test such applications and the functionality of such TI products as used in such applications. TI has not conducted any testing other than that specifically described in the published documentation for a particular TI Resource.

You are authorized to use, copy and modify any individual TI Resource only in connection with the development of applications that include the TI product(s) identified in such TI Resource. NO OTHER LICENSE, EXPRESS OR IMPLIED, BY ESTOPPEL OR OTHERWISE TO ANY OTHER TI INTELLECTUAL PROPERTY RIGHT, AND NO LICENSE TO ANY TECHNOLOGY OR INTELLECTUAL PROPERTY RIGHT OF TI OR ANY THIRD PARTY IS GRANTED HEREIN, including but not limited to any patent right, copyright, mask work right, or other intellectual property right relating to any combination, machine, or process in which TI products or services are used. Information regarding or referencing third-party products or services does not constitute a license to use such products or services, or a warranty or endorsement thereof. Use of TI Resources may require a license from a third party under the patents or other intellectual property of the third party, or a license from TI under the patents or other intellectual property of TI.

TI RESOURCES ARE PROVIDED "AS IS" AND WITH ALL FAULTS. TI DISCLAIMS ALL OTHER WARRANTIES OR REPRESENTATIONS, EXPRESS OR IMPLIED, REGARDING TI RESOURCES OR USE THEREOF, INCLUDING BUT NOT LIMITED TO ACCURACY OR COMPLETENESS, TITLE, ANY EPIDEMIC FAILURE WARRANTY AND ANY IMPLIED WARRANTIES OF MERCHANTABILITY, FITNESS FOR A PARTICULAR PURPOSE, AND NON-INFRINGEMENT OF ANY THIRD PARTY INTELLECTUAL PROPERTY RIGHTS.

TI SHALL NOT BE LIABLE FOR AND SHALL NOT DEFEND OR INDEMNIFY YOU AGAINST ANY CLAIM, INCLUDING BUT NOT LIMITED TO ANY INFRINGEMENT CLAIM THAT RELATES TO OR IS BASED ON ANY COMBINATION OF PRODUCTS EVEN IF DESCRIBED IN TI RESOURCES OR OTHERWISE. IN NO EVENT SHALL TI BE LIABLE FOR ANY ACTUAL, DIRECT, SPECIAL, COLLATERAL, INDIRECT, PUNITIVE, INCIDENTAL, CONSEQUENTIAL OR EXEMPLARY DAMAGES IN CONNECTION WITH OR ARISING OUT OF TI RESOURCES OR USE THEREOF, AND REGARDLESS OF WHETHER TI HAS BEEN ADVISED OF THE POSSIBILITY OF SUCH DAMAGES.

You agree to fully indemnify TI and its representatives against any damages, costs, losses, and/or liabilities arising out of your non-compliance with the terms and provisions of this Notice.

This Notice applies to TI Resources. Additional terms apply to the use and purchase of certain types of materials, TI products and services. These include; without limitation, TI's standard terms for semiconductor products (<http://www.ti.com/sc/docs/stdterms.htm>), [evaluation modules](#), and [samples](http://www.ti.com/sc/docs/sampterm.htm) (<http://www.ti.com/sc/docs/sampterm.htm>).

Mailing Address: Texas Instruments, Post Office Box 655303, Dallas, Texas 75265
Copyright © 2017, Texas Instruments Incorporated