

High-Performance Miniature 1.5-A Step-Down DC-DC Converter for Handheld Applications

Check for Samples: [LM3678](#)

FEATURES

- $V_{OUT} = 0.8\text{ V}$ or 1.2 V
- $V_{IN} = 2.5\text{ V}$ to 5.5 V
- **1.5-A Maximum Load Capability**
- **3.3-MHz (Typical) PWM Fixed Switching Frequency Allows Use of 1- μH Inductor**
- **$\pm 3\%$ DC Output Voltage Precision**
- **0.01- μA (Typical) Shutdown Current**
- **Internal Synchronous Rectification for High Efficiency**
- **Internal Soft Start**
- **Current Overload and Thermal Shutdown Protection**

APPLICATIONS

- PDAs and Smart Phones
- Personal Media Players
- W-LAN
- USB Modem Applications
- Digital Still Cameras
- Portable Hard Disk Drives

DESCRIPTION

The LM3678 step-down DC-DC converter is optimized for powering low-voltage circuits from a single Li-Ion cell battery and input voltage rails from 2.5 V to 5.5 V. It provides up to 1.5-A load current, over the entire input voltage range. LM3678 offers a 0.8V or 1.2V option. One of the pair of voltages is set through the VSELECT pin.

LM3678 operates in PWM mode with a fixed frequency of 3.3 MHz. Internal synchronous rectification provides high efficiency during PWM mode operation. In shutdown mode, the device turns off and reduces battery consumption to 0.01 μA (typical).

The LM3678 is available in a 3mm x 3mm DSC-10 package. A high switching frequency of 3.3 MHz (typical) allows use of tiny surface-mount components. Only three external surface-mount components, an inductor and two ceramic capacitors, are required (solution size less than 33 mm²). For voltages other than the voltage shown, contact TI or your distributor.

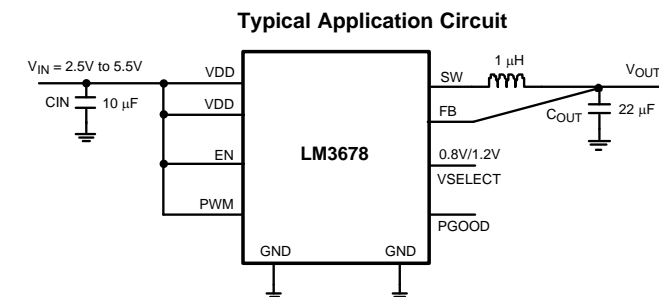
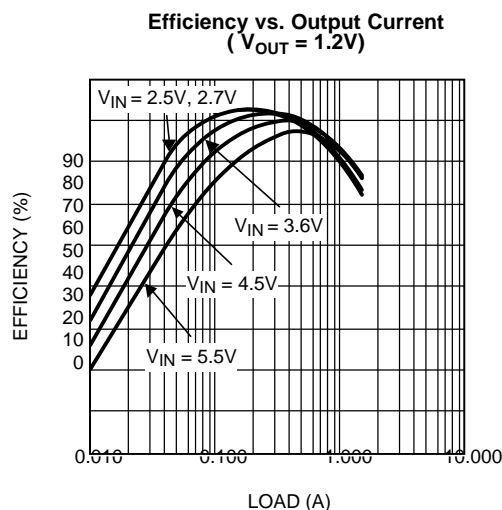
NOTE: $V_{SEL\ H} = 1.2\text{V}$, $V_{SEL\ L} = 0.8\text{V}$
Figure 1.

Figure 2.

Please be aware that an important notice concerning availability, standard warranty, and use in critical applications of Texas Instruments semiconductor products and disclaimers thereto appears at the end of this data sheet.

All trademarks are the property of their respective owners.

Functional Block Diagram

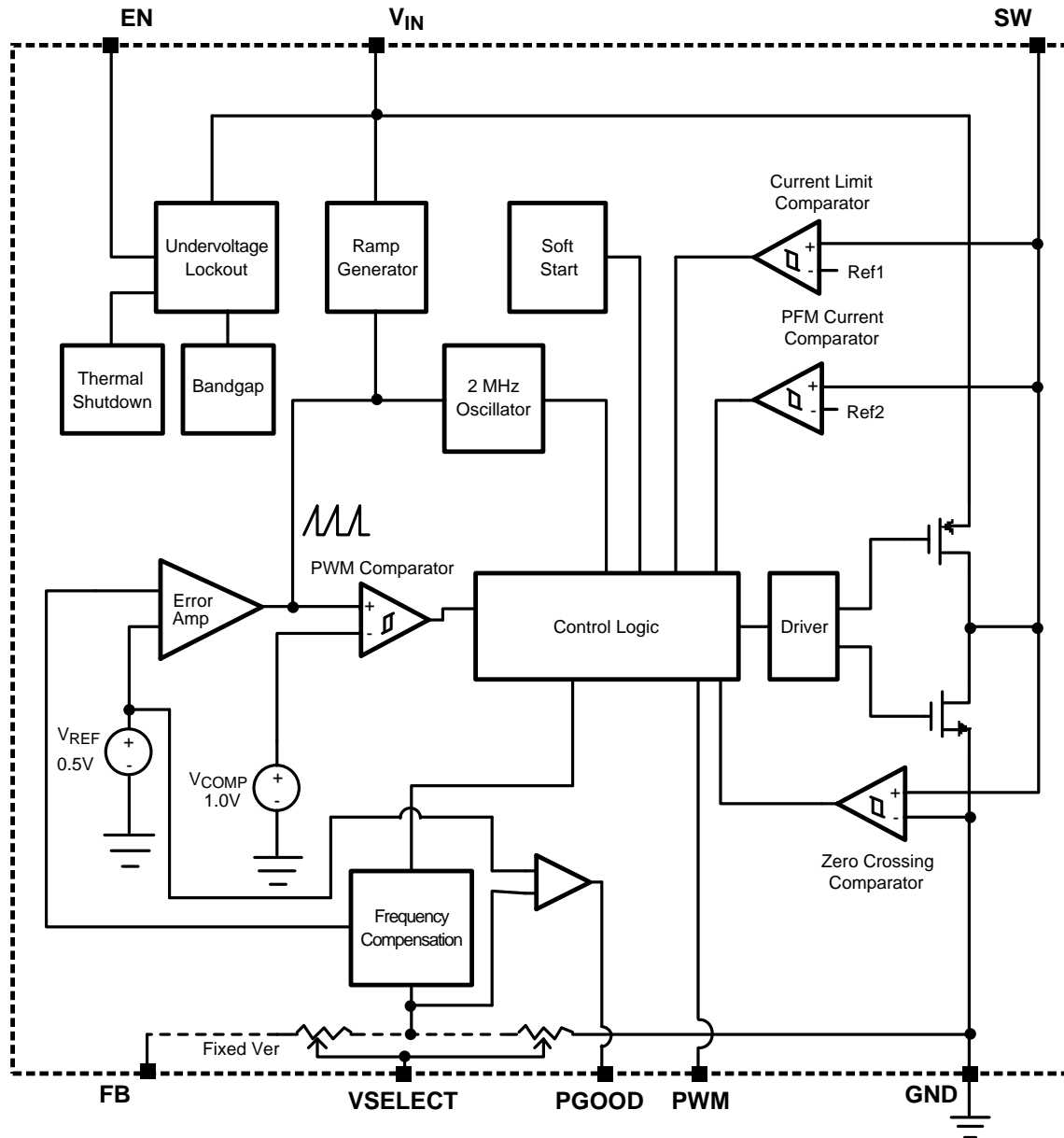
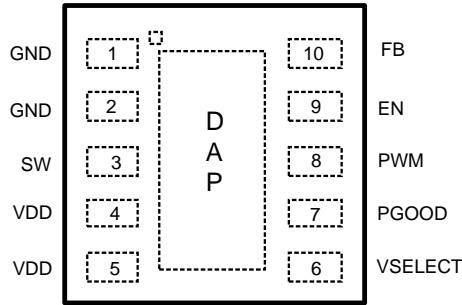
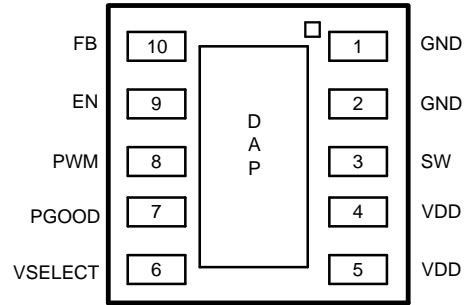

Figure 3. LM3678 Block Diagram

Connection Diagram and Package Mark Information

Figure 4. Top View

Figure 5. Bottom View
Table 1. Pin Descriptions

Pin No.	Name	Description
1	GND	Power Ground pin.
2	GND	Analog Ground Pin
3	SW	Switching node connection to the internal PFET switch and NFET synchronous rectifier
4	VDD	Analog supply input. Connect to the input filter capacitor (see Figure 1).
5	VDD	Power supply Input. Connect to the input filter capacitor (see Figure 1).
6	VSELECT	Output voltage select (For example) VSELECT = LOW, $V_{OUT} = 0.8V$ VSELECT = HIGH, $V_{OUT} = 1.2V$
7	PGOOD	Power Good Flag. This common drain logic output is pulled to ground when the output voltage is not within $\pm 7.5\%$ of regulation.
8	PWM	Connect PWM pin to VIN.
9	EN	Enable pin. The device is in shutdown mode when voltage to this pin is $< 0.4V$ and enabled when $> 1.0V$. Do not leave this pin floating.
10	FB	Feedback analog input. Connect directly to the output filter capacitor for fixed voltage versions.
DAP	DAP	Die Attach Pad, connect the DAP to GND on PCB layout to enhance thermal performance. It should not be used as a primary ground connection.



These devices have limited built-in ESD protection. The leads should be shorted together or the device placed in conductive foam during storage or handling to prevent electrostatic damage to the MOS gates.

Absolute Maximum Ratings⁽¹⁾

V_{IN} Pin: Voltage to GND	-0.2V to 6.0V
EN Pin	-0.2V to 6.0V
FB, SW Pin	(GND-0.2V) to ($V_{IN} + 0.2V$)
Continuous Power Dissipation ⁽²⁾	Internally Limited
Junction Temperature (T_{J-MAX})	+150°C
Storage Temperature Range	-65°C to +150°C
Maximum Lead Temperature (Soldering, 10 seconds)	260°C

- (1) Absolute Maximum Ratings indicate limits beyond which damage to the device may occur. Operating Ratings are conditions under which the device operates. Operating Ratings do not imply specified performance limits. For specified performance limits and associated test conditions, see the Electrical Characteristics.
- (2) Internal thermal shutdown circuitry protects the device from permanent damage. Thermal shutdown engages at $T_J = 150^\circ\text{C}$ (typ) and disengages at $T_J = 130^\circ\text{C}$ (typ).

Operating Ratings⁽¹⁾⁽²⁾

Input Voltage Range	2.5V to 5.5V
Recommended Load Current	0mA to 1.5A
Junction Temperature (T _J) Range	-30°C to +125°C
Ambient Temperature (T _A) Range ⁽³⁾	-30°C to +85°C

- (1) Absolute Maximum Ratings indicate limits beyond which damage to the device may occur. Operating Ratings are conditions under which the device operates. Operating Ratings do not imply specified performance limits. For specified performance limits and associated test conditions, see the Electrical Characteristics.
- (2) All voltages are with respect to the potential at the GND pin.
- (3) In applications with high power dissipation or poor package resistance, the maximum ambient temperature may need to be derated. Maximum ambient temperature (T_{A-MAX}) is dependent on the maximum operating junction temperature (T_{J-MAX}), the maximum power dissipation of the device in the application (P_{D-MAX}) and the junction to ambient thermal resistance of the package (θ_{JA}) in the application, as given by the following equation: $T_{A-MAX} = T_{J-MAX} - (\theta_{JA} \times P_{D-MAX})$.

Thermal Properties

Junction-to-Ambient Thermal Resistance (θ _{JA}) (DSC-10) for 4-layer board ⁽¹⁾	49.8°C/W
---	----------

- (1) Junction-to-ambient thermal resistance is highly application and board layout dependent. In applications where high power dissipation exists, special care must be given to thermal dissipation issues in board design.

Electrical Characteristics⁽¹⁾⁽²⁾⁽³⁾⁽⁴⁾

Limits in standard typeface are for T_J = 25°C. Limits in **boldface** type apply over the full operating ambient temperature range (-30°C ≤ T_A ≤ +85°C). Unless otherwise noted, specifications apply to the LM3678 Typical Application Circuit (see [Figure 1](#)) with V_{IN} = EN = 3.6V

Symbol	Parameter	Test Conditions	Min	Typ	Max	Unit
V _{FB}	Feedback voltage	VSELECT = Low and High	-3		+3	%
V _{REF}	Internal reference voltage			0.5		V
R _{DS(on) (P)}	Pin-to-pin resistance for PFET	V _{IN} = V _{GS} = 3.6V		150	200	mΩ
R _{DS(on) (N)}	Pin-to-pin resistance for NFET	V _{IN} = V _{GS} = 3.6V		110	150	mΩ
I _{LIM}	Switch peak current limit	Open loop	1.9	2.15	2.4	A
I _{SHDN}	Shutdown supply current	EN = 0V			1	μA
V _{IH}	Logic high input for EN and VSELECT	V _{IN} = 3.6V	1.2			V
V _{IL}	Logic low input for EN and VSELECT	V _{IN} = 3.6V			0.4	V
I _{EN}	Enable (EN) input current			0.01	1	μA
F _{OSC}	Internal oscillator frequency	PWM Mode	2.7	3.3	3.6	MHz

- (1) All voltages are with respect to the potential at the GND pin.
- (2) Refer to [Typical Performance Characteristics](#) for closed loop data and its variation with regards to supply voltage and temperature. Electrical Characteristics reflects open loop data (FB=0V and current drawn from SW pin ramped up until cycle by cycle current limit is activated). Closed loop current limit is the peak inductor current measured in the application circuit by increasing output current until output voltage drops by 10%.
- (3) The parameters in the electrical characteristic table are tested at V_{IN} = 3.6V unless otherwise specified. For performance over the input voltage range, see [Typical Performance Characteristics](#).
- (4) Min and Max limits are specified by design, test or statistical analysis. Typical numbers represent the most likely norm.

Typical Performance Characteristics

LM3678SD, Circuit of Figure 1, $V_{IN} = 3.6V$, $V_{OUT} = 1.2V$, $C_{IN} = 10\mu F$, $C_{OUT} = 22\mu F$, and $T_A = 25^\circ C$, unless otherwise noted.

Quiescent Supply Current vs. Temperature

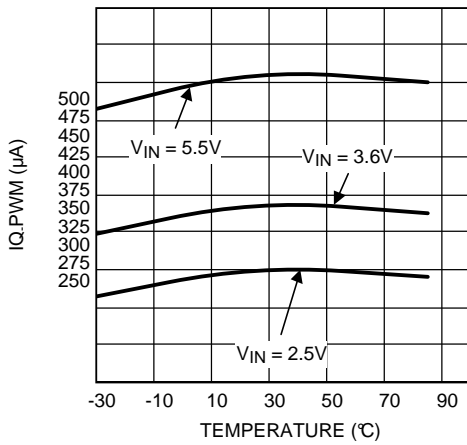

Figure 6.

Switching Frequency vs. Temperature

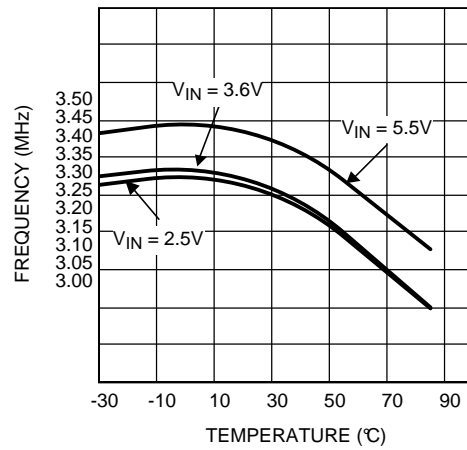

Figure 7.

NFET $R_{DS(ON)}$ vs. Temperature

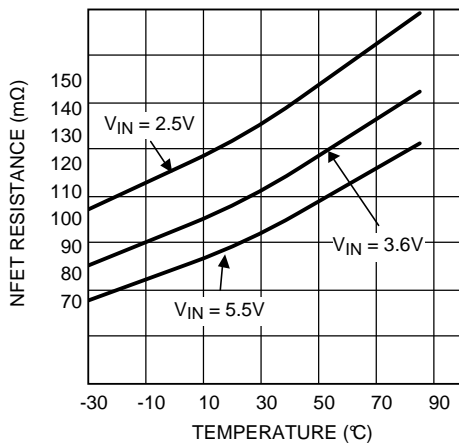

Figure 8.

PFET $R_{DS(ON)}$ vs. Temperature

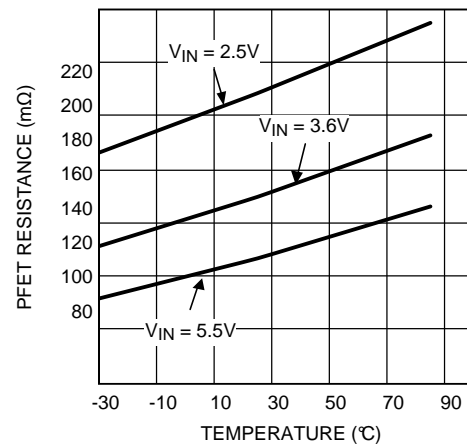

Figure 9.

I_{LIMIT} vs. Temperature (Open Loop)

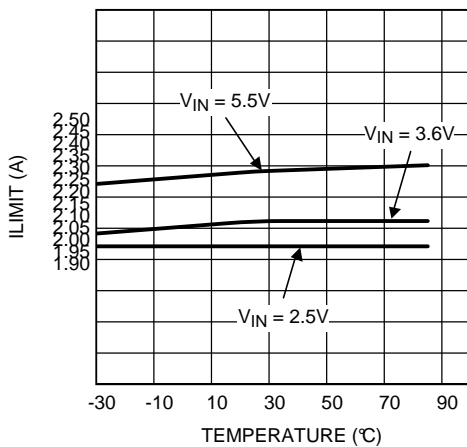

Figure 10.

Efficiency PWM Mode vs. I_{LOAD} (0.8V)

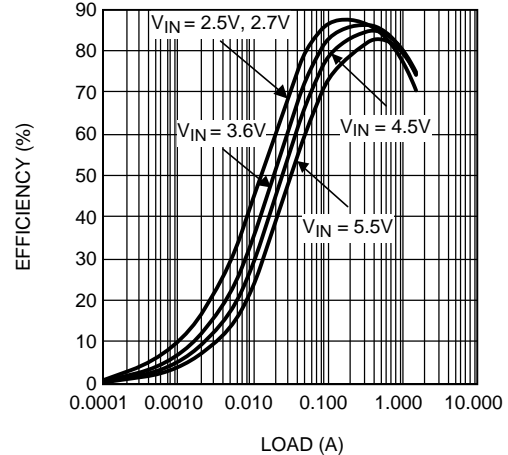

Figure 11.

Typical Performance Characteristics (continued)

LM3678SD, Circuit of Figure 1, $V_{IN} = 3.6V$, $V_{OUT} = 1.2V$, $C_{IN} = 10\mu F$, $C_{OUT} = 22\mu F$, and $T_A = 25^\circ C$, unless otherwise noted.

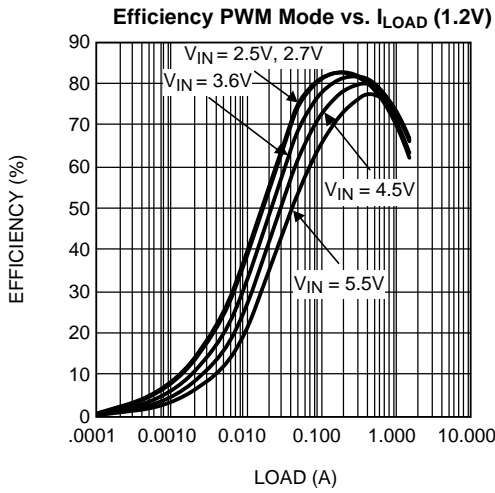

Figure 12.

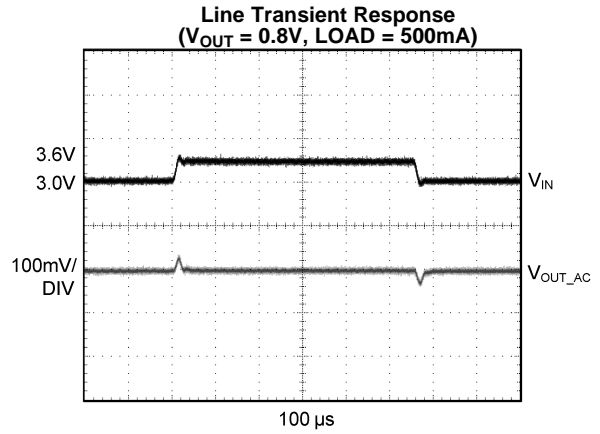

Figure 13.

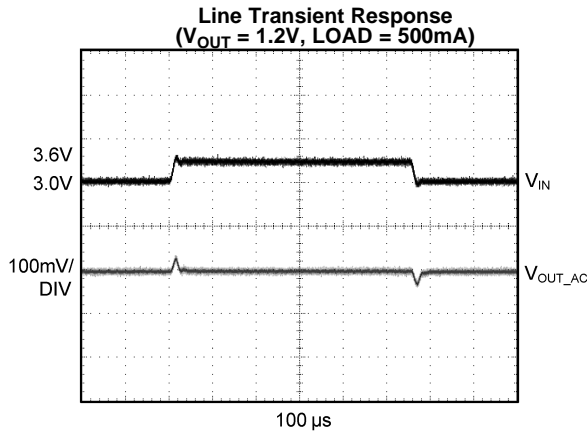

Figure 14.

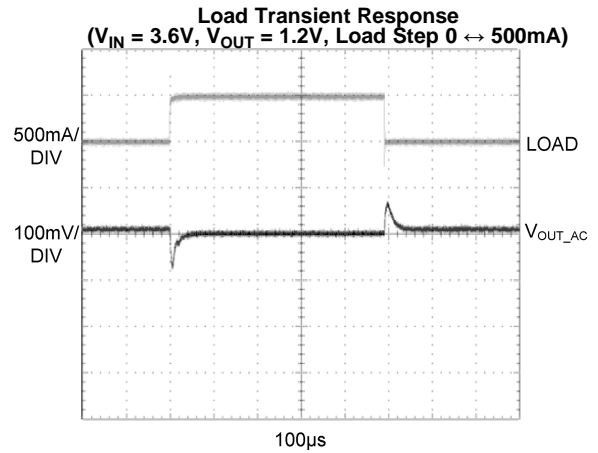

Figure 15.

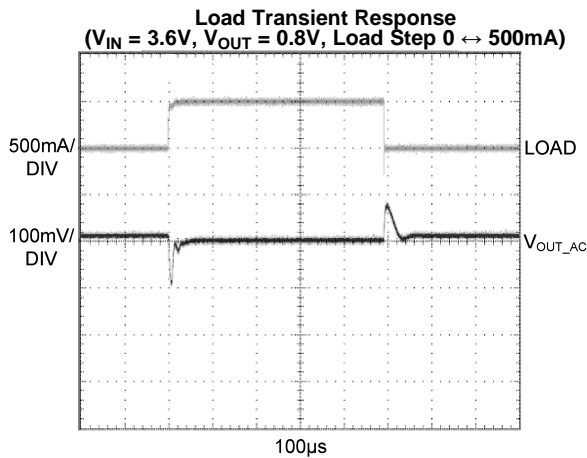

Figure 16.

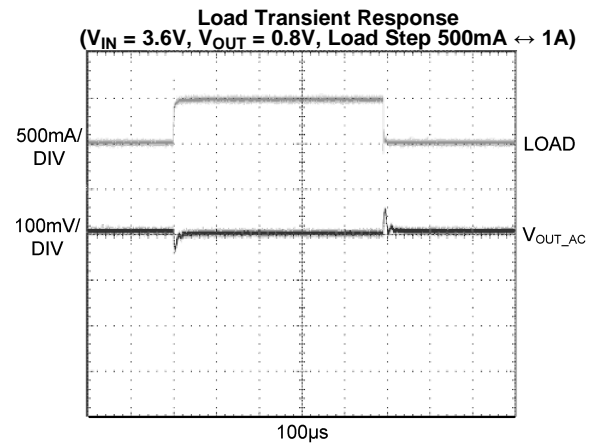

Figure 17.

Typical Performance Characteristics (continued)

LM3678SD, Circuit of Figure 1, $V_{IN} = 3.6V$, $V_{OUT} = 1.2V$, $C_{IN} = 10\mu F$, $C_{OUT} = 22\mu F$, and $T_A = 25^\circ C$, unless otherwise noted.

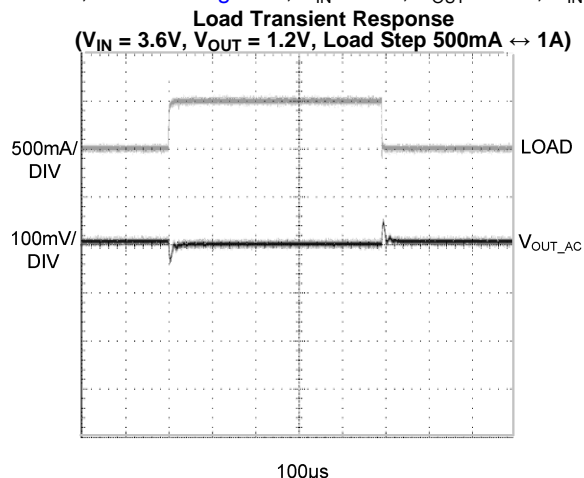

Figure 18.

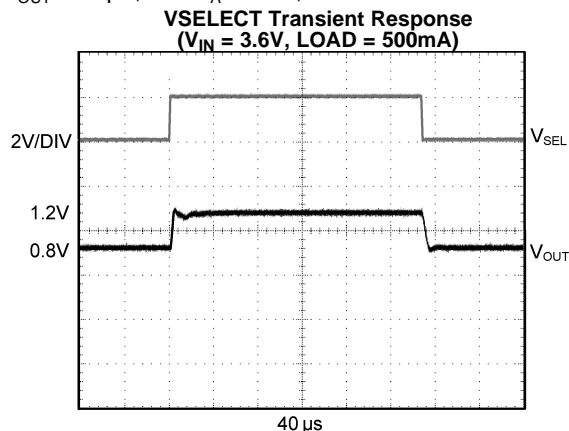

Figure 19.

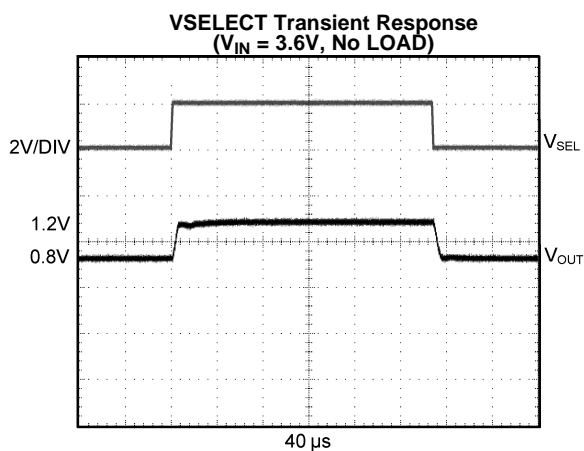

Figure 20.

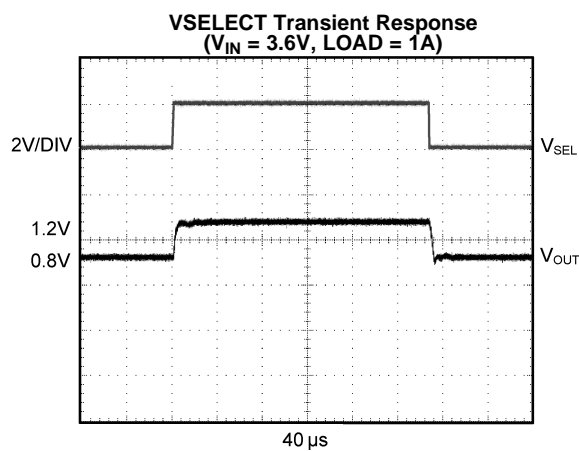

Figure 21.

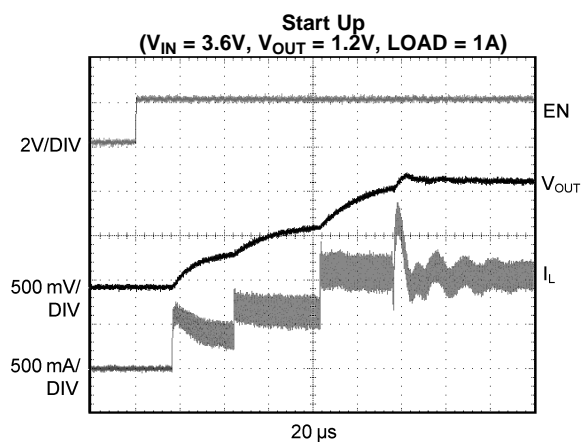

Figure 22.

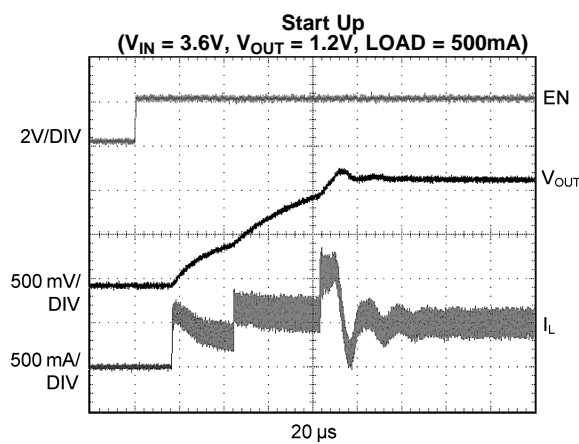
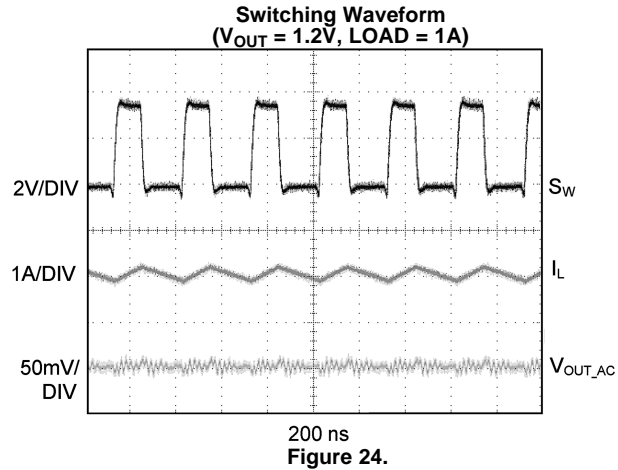

Figure 23.

Typical Performance Characteristics (continued)

LM3678SD, Circuit of [Figure 1](#), $V_{IN} = 3.6V$, $V_{OUT} = 1.2V$, $C_{IN} = 10\mu F$, $C_{OUT} = 22\mu F$, and $T_A = 25^\circ C$, unless otherwise noted.



OPERATION DESCRIPTION

DEVICE INFORMATION

The LM3678, a high-efficiency step-down DC-DC switching buck converter, delivers a constant voltage from a single Li-Ion battery and input voltage rails from 2.5 V to 5.5 V to portable devices such as cell phones and PDAs. Using a voltage mode architecture with synchronous rectification, the LM3678 has the ability to deliver up to 1.5 A, depending on the input voltage, output voltage, ambient temperature and the inductor chosen.

Additional features include soft start, undervoltage protection, current overload protection, and thermal shutdown protection. As shown in [Figure 1](#), only three external power components are required for implementation.

The part uses an internal reference voltage of 0.5 V. It is recommended to keep the part in shutdown until the input voltage is 2.5 V or higher.

CIRCUIT OPERATION

During the first portion of each switching cycle, the control block in the LM3678 turns on the internal PFET switch. This allows current to flow from the input through the inductor to the output filter capacitor and load. The inductor limits the current to a ramp with a slope of $(V_{IN}-V_{OUT})/L$, by storing energy in a magnetic field.

During the second portion of each cycle, the controller turns the PFET switch off, blocking current flow from the input, and then turns the NFET synchronous rectifier on. The inductor draws current from ground through the NFET to the output filter capacitor and load, which ramps the inductor current down with a slope of $-V_{OUT}/L$.

The output filter stores charge when the inductor current is high, and releases it when inductor current is low, smoothing the voltage across the load.

The output voltage is regulated by modulating the PFET switch on time to control the average current sent to the load. The effect is identical to sending a duty-cycle modulated rectangular wave formed by the switch and synchronous rectifier at the SW pin to a low-pass filter formed by the inductor and output filter capacitor. The output voltage is equal to the average voltage at the SW pin.

PWM OPERATION

During device operation the converter operates as a voltage-mode controller with input voltage feed forward. This allows the converter to achieve good load and line regulation. The DC gain of the power stage is proportional to the input voltage. To eliminate this dependence, feed forward inversely proportional to the input voltage is introduced.

The output voltage is regulated by switching at a constant frequency and then modulating the energy per cycle to control power to the load. At the beginning of each clock cycle the PFET switch is turned on and the inductor current ramps up until the comparator trips and the control logic turns off the switch. The current limit comparator can also turn off the switch in case the current limit of the PFET is exceeded. Then the NFET switch is turned on and the inductor current ramps down. The next cycle is initiated by the clock turning off the NFET and turning on the PFET.

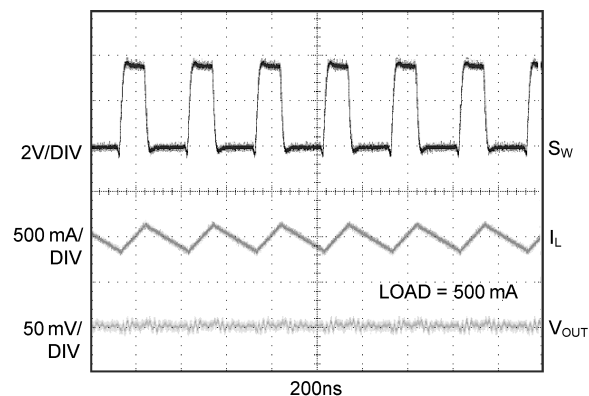

Figure 25. Typical PWM Operation

INTERNAL SYNCHRONOUS RECTIFICATION

The LM3678 uses an internal NFET as a synchronous rectifier to reduce rectifier forward voltage drop and associated power loss. Synchronous rectification provides a significant improvement in efficiency whenever the output voltage is relatively low compared to the voltage drop across an ordinary rectifier diode.

CURRENT LIMITING

A current limit feature allows the LM3678 to protect itself and external components during overload conditions by implementing current limiting with an internal comparator that trips at 2.15A (typ). If the output is shorted to ground the device enters a timed current limit mode where the NFET is turned on for a longer duration until the inductor current falls below a low threshold. This allows the inductor current more time to decay, thereby preventing runaway.

SHUTDOWN MODE

Setting the EN input pin low (<0.4V) places the LM3678 in shutdown mode. During shutdown the PFET switch, NFET switch, reference, control and bias circuitry of the LM3678 are turned off. Setting EN high (>1.0V) enables normal operation. It is recommended to set EN pin low to turn off the LM3678 during system power up and undervoltage conditions when the supply is less than 2.5V. Do not leave the EN pin floating.

SOFT START

The LM3678 has a soft-start circuit that limits in-rush current during start-up. During start-up the switch current limit is increased in steps. Soft start is activated only if EN goes from logic low to logic high after V_{IN} reaches 2.5V. Soft start is implemented by increasing switch current limit in steps of 250mA, 500mA, 1A and 2A (typical switch current limit). The start-up time thereby depends on the output capacitor and load current demanded at start-up.

Inductor Selection

There are two main considerations when choosing an inductor; the inductor should not saturate, and the inductor current ripple should be small enough to achieve the desired output voltage ripple. Different saturation current rating specifications are followed by different manufacturers so attention must be given to details. Saturation current ratings are typically specified at 25°C. However, ratings at the maximum ambient temperature of application should be requested from the manufacturer. Shielded inductors radiate less noise and should be preferred.

There are two methods to choose the inductor saturation current rating.

Method 1:

The saturation current should be greater than the sum of the maximum load current and the worst case average to peak inductor current. This can be written as

$$I_{SAT} > I_{OUTMAX} + I_{RIPPLE}$$

$$\text{where } I_{RIPPLE} = \left(\frac{V_{IN} - V_{OUT}}{2 * L} \right) * \left(\frac{V_{OUT}}{V_{IN}} \right) * \left(\frac{1}{f} \right) \quad (1)$$

- I_{RIPPLE} : average to peak inductor current
- I_{OUTMAX} : maximum load current (1.5A)
- V_{IN} : maximum input voltage in application
- L : minimum inductor value including worst case tolerances (30% drop can be considered for method 1)
- f : minimum switching frequency (2.7Mhz)
- V_{OUT} : output voltage

For a more conservative approach, a 1µH inductor with a saturation current rating of at least 2.5A is recommended for most applications.

Input Capacitor Selection

A ceramic input capacitor of 10 μ F, 6.3V is sufficient for most applications. Place the input capacitor as close as possible to the V_{IN} pin of the device. A larger value may be used for improved input voltage filtering. Use X7R or X5R types; do not use Y5V. DC bias characteristics of ceramic capacitors must be considered when selecting case sizes like 0805 and 0603. The input filter capacitor supplies current to the PFET switch of the LM3678 in the first half of each cycle and reduces voltage ripple imposed on the input power source. A ceramic capacitor's low ESR provides the best noise filtering of the input voltage spikes due to this rapidly changing current. Select a capacitor with sufficient ripple current rating. The input current ripple can be calculated as:

$$I_{RMS} = I_{OUTMAX} * \sqrt{\frac{V_{OUT}}{V_{IN}} * \left(1 - \frac{V_{OUT}}{V_{IN}} + \frac{r^2}{12}\right)}$$

$$r = \frac{(V_{IN} - V_{OUT}) * V_{OUT}}{L * f * I_{OUTMAX} * V_{IN}}$$

The worst case is when $V_{IN} = 2 * V_{OUT}$ (2)

Table 2. Suggest Inductors and Their Suppliers

Model	Vendor	Dimensions LxWxH (mm)	D.C.R (max)	I_{SAT}
NR4012T1R0N	Taiyo Yuden	4 x 4 x 1.2	60m Ω	2.5A
LPS4012-102L	Coilcraft	3.9 x 3.9 x 1.2	100m Ω	2.5A
LPS4012-102L	Coilcraft	3.9 x 3.9 x 1.8	40m Ω	3.4A

Output Capacitor Selection

A ceramic output capacitor of 22 μ F, 6.3V is sufficient for most applications. Use X7R or X5R types; do not use Y5V. DC bias characteristics of ceramic capacitors must be considered when selecting case sizes like 0805 and 0603. DC bias characteristics vary from manufacturer to manufacturer and dc bias curves should be requested from them as part of the capacitor selection process.

The output filter capacitor smooths out current flow from the inductor to the load, helps maintain a steady output voltage during transient load changes and reduces output voltage ripple. These capacitors must be selected with sufficient capacitance and sufficiently low ESR to perform these functions.

The output voltage ripple is caused by the charging and discharging of the output capacitor and by the R_{ESR} and can be calculated as:

Voltage peak-to-peak ripple due to capacitance can be expressed as follow:

$$V_{PP-C} = \frac{I_{RIPPLE}}{4 * f * C} \quad (3)$$

Voltage peak-to-peak ripple due to ESR can be expressed as follow:

$$V_{PP-ESR} = (2 * I_{RIPPLE}) * R_{ESR}$$

Because these two components are out of phase the RMS (root mean squared) value can be used to get an approximate value of peak-to-peak ripple.

The peak-to-peak ripple voltage RMS value can be expressed as follow:

$$V_{PP-RMS} = \sqrt{V_{PP-C}^2 + V_{PP-ESR}^2} \quad (4)$$

Note that the output voltage ripple is dependent on the inductor current ripple and the equivalent series resistance of the output capacitor (R_{ESR}).

The R_{ESR} is frequency dependent (as well as temperature dependent); make sure the value used for calculations is at the switching frequency of the part.

Table 3. Suggested Capacitors and Their Suppliers

Model	Type	Vendor	Voltage Rating	Case Size Inch (mm)
10μF for C_{IN}				
GRM21BR60J106K	Ceramic, X5R	Murata	6.3V	0805 (2012)
JMK212BJ106K	Ceramic, X5R	Taiyo-Yuden	6.3V	0805 (2012)
C2012X5R0J106K	Ceramic, X5R	TDK	6.3V	0805 (2012)
22μF for C_{OUT}				
JMK212BJ226MG	Ceramic, X5R	Taiyo-Yuden	6.3V	0805 (2012)

Board Layout Considerations

PC board layout is an important part of DC-DC converter design. Poor board layout can disrupt the performance of a DC-DC converter and surrounding circuitry by contributing to EMI, ground bounce, and resistive voltage loss in the traces. These can send erroneous signals to the DC-DC converter IC, resulting in poor regulation or instability.

Good layout for the LM3678 can be implemented by following a few simple design rules below.

1. *Place the LM3678, inductor and filter capacitors close together and make the traces short.* The traces between these components carry relatively high switching currents and act as antennas. Following this rule reduces radiated noise. Special care must be given to place the input filter capacitor very close to the V_{IN} and GND pin.
2. *Arrange the components so that the switching current loops curl in the same direction.* During the first half of each cycle, current flows from the input filter capacitor through the LM3678 and inductor to the output filter capacitor and back through ground, forming a current loop. In the second half of each cycle, current is pulled up from ground through the LM3678 by the inductor to the output filter capacitor and then back through ground forming a second current loop. Routing these loops so the current curls in the same direction prevents magnetic field reversal between the two half-cycles and reduces radiated noise.
3. *Connect the ground pins of the LM3678 and filter capacitors together using generous component-side copper fill as a pseudo-ground plane. Then, connect this to the ground-plane (if one is used) with several vias.* This reduces ground-plane noise by preventing the switching currents from circulating through the ground plane. It also reduces ground bounce at the LM3678 by giving it a low-impedance ground connection.
4. *Use wide traces between the power components and for power connections to the DC-DC converter circuit.* This reduces voltage errors caused by resistive losses across the traces.
5. *Route noise sensitive traces, such as the voltage feedback path, away from noisy traces between the power components.* The voltage feedback trace must remain close to the LM3678 circuit and should be direct but should be routed opposite to noisy components. This reduces EMI radiated onto the DC-DC converter's own voltage feedback trace. A good approach is to route the feedback trace on another layer and to have a ground plane between the top layer and layer on which the feedback trace is routed. In the same manner for the adjustable part it is desired to have the feedback dividers on the bottom layer.
6. *Place noise sensitive circuitry, such as radio IF blocks, away from the DC-DC converter, CMOS digital blocks and other noisy circuitry.* Interference with noise-sensitive circuitry in the system can be reduced through distance.

For detailed layout information, refer to Application Note 1722 *LM3678 Evaluation Board* [SNVA289](#).

In mobile phones, for example, a common practice is to place the DC-DC converter on one corner of the board, arrange the CMOS digital circuitry around it (since this also generates noise), and then place sensitive preamplifiers and IF stages on the diagonally opposing corner. Often, the sensitive circuitry is shielded with a metal pan and power to it is post-regulated to reduce conducted noise, using low-dropout linear regulators.

REVISION HISTORY

Changes from Revision B (April 2013) to Revision C	Page
• Changed layout of National Data Sheet to TI format	12

PACKAGING INFORMATION

Orderable Device	Status (1)	Package Type	Package Drawing	Pins	Package Qty	Eco Plan (2)	Lead/Ball Finish (6)	MSL Peak Temp (3)	Op Temp (°C)	Device Marking (4/5)	Samples
LM3678SD-1.2/NOPB	ACTIVE	WSON	DSC	10	1000	Green (RoHS & no Sb/Br)	SN	Level-1-260C-UNLIM	-30 to 85	S021B	Samples
LM3678SDE-1.2/NOPB	ACTIVE	WSON	DSC	10	250	Green (RoHS & no Sb/Br)	SN	Level-1-260C-UNLIM	-30 to 85	S021B	Samples

(1) The marketing status values are defined as follows:

ACTIVE: Product device recommended for new designs.

LIFEBUY: TI has announced that the device will be discontinued, and a lifetime-buy period is in effect.

NRND: Not recommended for new designs. Device is in production to support existing customers, but TI does not recommend using this part in a new design.

PREVIEW: Device has been announced but is not in production. Samples may or may not be available.

OBSELETE: TI has discontinued the production of the device.

(2) **RoHS:** TI defines "RoHS" to mean semiconductor products that are compliant with the current EU RoHS requirements for all 10 RoHS substances, including the requirement that RoHS substance do not exceed 0.1% by weight in homogeneous materials. Where designed to be soldered at high temperatures, "RoHS" products are suitable for use in specified lead-free processes. TI may reference these types of products as "Pb-Free".

RoHS Exempt: TI defines "RoHS Exempt" to mean products that contain lead but are compliant with EU RoHS pursuant to a specific EU RoHS exemption.

Green: TI defines "Green" to mean the content of Chlorine (Cl) and Bromine (Br) based flame retardants meet JS709B low halogen requirements of <=1000ppm threshold. Antimony trioxide based flame retardants must also meet the <=1000ppm threshold requirement.

(3) MSL, Peak Temp. - The Moisture Sensitivity Level rating according to the JEDEC industry standard classifications, and peak solder temperature.

(4) There may be additional marking, which relates to the logo, the lot trace code information, or the environmental category on the device.

(5) Multiple Device Markings will be inside parentheses. Only one Device Marking contained in parentheses and separated by a "-" will appear on a device. If a line is indented then it is a continuation of the previous line and the two combined represent the entire Device Marking for that device.

(6) Lead/Ball Finish - Orderable Devices may have multiple material finish options. Finish options are separated by a vertical ruled line. Lead/Ball Finish values may wrap to two lines if the finish value exceeds the maximum column width.

Important Information and Disclaimer:The information provided on this page represents TI's knowledge and belief as of the date that it is provided. TI bases its knowledge and belief on information provided by third parties, and makes no representation or warranty as to the accuracy of such information. Efforts are underway to better integrate information from third parties. TI has taken and continues to take reasonable steps to provide representative and accurate information but may not have conducted destructive testing or chemical analysis on incoming materials and chemicals. TI and TI suppliers consider certain information to be proprietary, and thus CAS numbers and other limited information may not be available for release.

In no event shall TI's liability arising out of such information exceed the total purchase price of the TI part(s) at issue in this document sold by TI to Customer on an annual basis.

TAPE AND REEL INFORMATION

QUADRANT ASSIGNMENTS FOR PIN 1 ORIENTATION IN TAPE

*All dimensions are nominal

Device	Package Type	Package Drawing	Pins	SPQ	Reel Diameter (mm)	Reel Width W1 (mm)	A0 (mm)	B0 (mm)	K0 (mm)	P1 (mm)	W (mm)	Pin1 Quadrant
LM3678SD-1.2/NOPB	WSON	DSC	10	1000	178.0	12.4	3.3	3.3	1.0	8.0	12.0	Q1
LM3678SDE-1.2/NOPB	WSON	DSC	10	250	178.0	12.4	3.3	3.3	1.0	8.0	12.0	Q1

TAPE AND REEL BOX DIMENSIONS



*All dimensions are nominal

Device	Package Type	Package Drawing	Pins	SPQ	Length (mm)	Width (mm)	Height (mm)
LM3678SD-1.2/NOPB	WSON	DSC	10	1000	210.0	185.0	35.0
LM3678SDE-1.2/NOPB	WSON	DSC	10	250	210.0	185.0	35.0

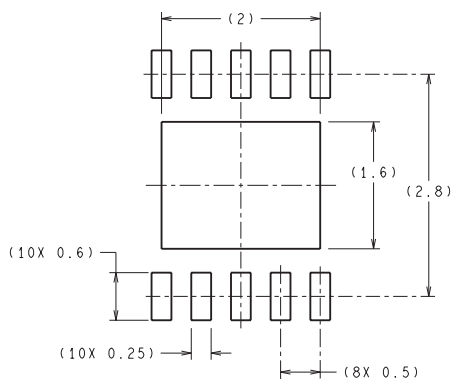
DSC0010A

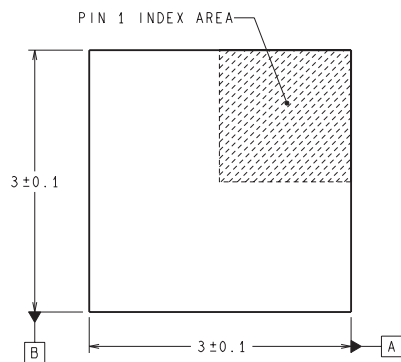

RECOMMENDED LAND PATTERN



DIMENSIONS ARE IN MILLIMETERS
DIMENSIONS IN () FOR REFERENCE ONLY

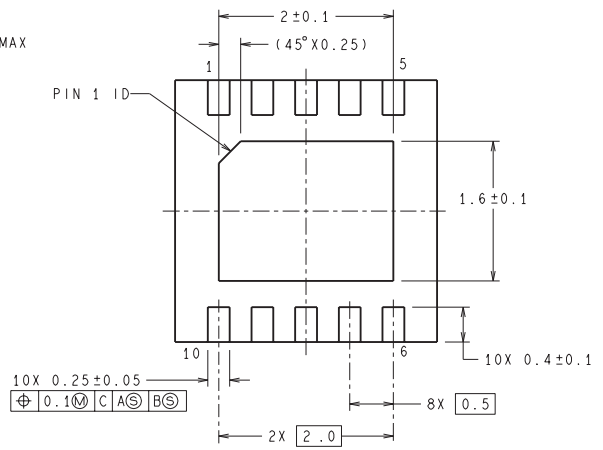
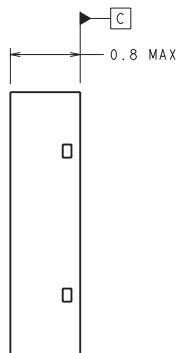
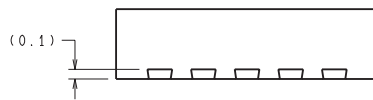

SDA10A (Rev A)

IMPORTANT NOTICE AND DISCLAIMER

TI PROVIDES TECHNICAL AND RELIABILITY DATA (INCLUDING DATASHEETS), DESIGN RESOURCES (INCLUDING REFERENCE DESIGNS), APPLICATION OR OTHER DESIGN ADVICE, WEB TOOLS, SAFETY INFORMATION, AND OTHER RESOURCES "AS IS" AND WITH ALL FAULTS, AND DISCLAIMS ALL WARRANTIES, EXPRESS AND IMPLIED, INCLUDING WITHOUT LIMITATION ANY IMPLIED WARRANTIES OF MERCHANTABILITY, FITNESS FOR A PARTICULAR PURPOSE OR NON-INFRINGEMENT OF THIRD PARTY INTELLECTUAL PROPERTY RIGHTS.

These resources are intended for skilled developers designing with TI products. You are solely responsible for (1) selecting the appropriate TI products for your application, (2) designing, validating and testing your application, and (3) ensuring your application meets applicable standards, and any other safety, security, or other requirements. These resources are subject to change without notice. TI grants you permission to use these resources only for development of an application that uses the TI products described in the resource. Other reproduction and display of these resources is prohibited. No license is granted to any other TI intellectual property right or to any third party intellectual property right. TI disclaims responsibility for, and you will fully indemnify TI and its representatives against, any claims, damages, costs, losses, and liabilities arising out of your use of these resources.

TI's products are provided subject to TI's Terms of Sale (www.ti.com/legal/termsofsale.html) or other applicable terms available either on ti.com or provided in conjunction with such TI products. TI's provision of these resources does not expand or otherwise alter TI's applicable warranties or warranty disclaimers for TI products.

Mailing Address: Texas Instruments, Post Office Box 655303, Dallas, Texas 75265
Copyright © 2020, Texas Instruments Incorporated