

LMH6583 16x8 550 MHz Analog Crosspoint Switch, Gain of 2

Check for Samples: [LMH6583](#)

FEATURES

- 16 Inputs and 8 Outputs
- 64-pin Exposed Pad HTQFP Package
 - -3 dB Bandwidth ($V_{OUT} = 2 V_{PP}$, $R_L = 1 k\Omega$) 550 MHz
 - -3 dB Bandwidth ($V_{OUT} = 2 V_{PP}$, $R_L = 150\Omega$) 450 MHz
- Fast Slew Rate 1800 V/ μ s
- Channel to Channel Crosstalk (10/ 100 MHz) -70/ -52 dBc
- All Hostile Crosstalk (10/ 100 MHz) -55/-45 dBc
- Easy to Use Serial Programming 4 Wire Bus
- Two Programming Modes Serial & Addressed Modes
- Symmetrical Pinout Facilitates Expansion.
- Output Current ± 60 mA
- Gain of 1 Version also Available LMH6582

APPLICATIONS

- Studio Monitoring/Production Video Systems
- Conference Room Multimedia Video Systems
- KVM (Keyboard Video Mouse) Systems
- Security/Surveillance Systems
- Multi Antenna Diversity Radio
- Video Test Equipment
- Medical Imaging
- Wide-Band Routers & Switches

DESCRIPTION

The LMH™ family of products is joined by the LMH6583, a high speed, non-blocking, analog, crosspoint switch. The LMH6583 is designed for high speed, DC coupled, analog signals like high resolution video (UXGA and higher). The LMH6583 has 16 inputs and 8 outputs. The non-blocking architecture allows an output to be connected to any input, including an input that is already selected. With fully buffered inputs the LMH6583 can be impedance matched to nearly any source impedance. The buffered outputs of the LMH6583 can drive up to two back terminated video loads (75 Ω load). The outputs and inputs also feature high impedance inactive states allowing high performance input and output expansion for array sizes such as 16 x 16 or 32 x 8 by combining two devices. The LMH6583 is controlled with a 4 pin serial interface. Both single serial mode and addressed chain modes are available.

The LMH6583 comes in a 64-pin thermally enhanced HTQFP package. It also has diagonally symmetrical pin assignments to facilitate double sided board layouts and easy pin connections for expansion.



Please be aware that an important notice concerning availability, standard warranty, and use in critical applications of Texas Instruments semiconductor products and disclaimers thereto appears at the end of this data sheet.

LMH is a trademark of Texas Instruments.

All other trademarks are the property of their respective owners.

Connection Diagram

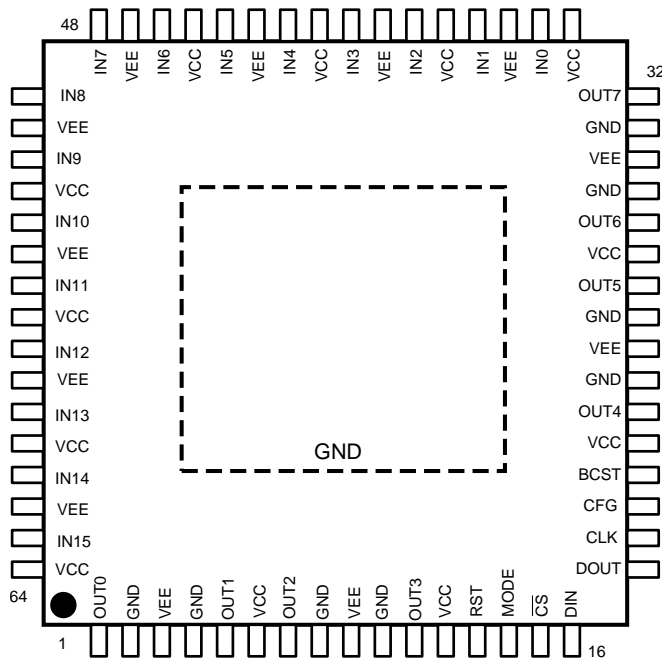

Figure 1. 64-Pin Exposed Pad HTQFP
See Package Number PAP0064A

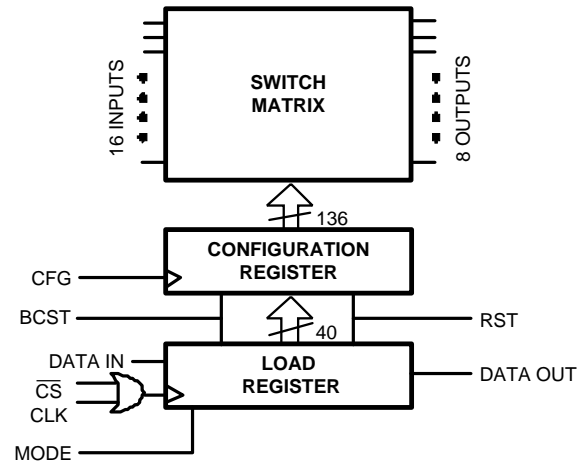

Figure 2. Block Diagram



These devices have limited built-in ESD protection. The leads should be shorted together or the device placed in conductive foam during storage or handling to prevent electrostatic damage to the MOS gates.

Absolute Maximum Ratings ⁽¹⁾⁽²⁾

ESD Tolerance ⁽³⁾	
Human Body Model	2000V
Machine Model	200V
V _S	±6V
I _{IN} (Input Pins)	±20 mA
I _{OUT}	⁽⁴⁾
Input Voltage Range	V ⁻ to V ⁺
Maximum Junction Temperature	+150°C
Storage Temperature Range	-65°C to +150°C
Soldering Information	
Infrared or Convection (20 sec.)	235°C
Wave Soldering (10 sec.)	260°C

- (1) Absolute Maximum Ratings indicate limits beyond which damage to the device may occur. Operating Ratings indicate conditions for which the device is intended to be functional, but specific performance is not ensured. For ensured specifications, see [±3.3V Electrical Characteristics](#) and [±5V Electrical Characteristics](#).
- (2) If Military/Aerospace specified devices are required, please contact the Texas Instruments Sales Office/ Distributors for availability and specifications.
- (3) Human Body Model, applicable std. MIL-STD-883, Method 3015.7. Machine Model, applicable std. JESD22-A115-A (ESD MM std. of JEDEC) Field-Induced Charge-Device Model, applicable std. JESD22-C101-C (ESD FICDM std. of JEDEC).
- (4) The maximum output current (I_{OUT}) is determined by device power dissipation limitations.

Operating Ratings ⁽¹⁾

Temperature Range ⁽²⁾	-40°C to +85°C	
Supply Voltage Range	±3V to ±5.5V	
Thermal Resistance	θ_{JA}	θ_{JC}
64-Pin Exposed Pad HTQFP	27°C/W	0.82°C/W

- (1) Absolute Maximum Ratings indicate limits beyond which damage to the device may occur. Operating Ratings indicate conditions for which the device is intended to be functional, but specific performance is not ensured. For ensured specifications, see [±3.3V Electrical Characteristics](#) and [±5V Electrical Characteristics](#).
- (2) The maximum power dissipation is a function of $T_{J(MAX)}$ and θ_{JA} . The maximum allowable power dissipation at any ambient temperature is $P_D = (T_{J(MAX)} - T_A) / \theta_{JA}$. All numbers apply for packages soldered directly onto a PC Board.

±3.3V Electrical Characteristics ⁽¹⁾

Unless otherwise specified, typical conditions are: $T_A = 25^\circ\text{C}$, $A_V = +2$, $V_S = \pm 3.3\text{V}$, $R_L = 100\Omega$; **Boldface** limits apply at the temperature extremes.

Symbol	Parameter	Conditions	Min ⁽²⁾	Typ ⁽³⁾	Max ⁽²⁾	Units
Frequency Domain Performance						
SSBW	-3 dB Bandwidth	$V_{OUT} = 0.5 V_{PP}$		425		MHz
LSBW		$V_{OUT} = 2 V_{PP}$, $R_L = 1\text{ k}\Omega$		500		
		$V_{OUT} = 2 V_{PP}$, $R_L = 150\Omega$		450		
GF	0.1 dB Gain Flatness	$V_{OUT} = 2 V_{PP}$, $R_L = 150\Omega$		80		MHz
DG	Differential Gain	$R_L = 150\Omega$, 3.58 MHz/ 4.43 MHz		0.05		%
DP	Differential Phase	$R_L = 150\Omega$, 3.58 MHz/ 4.43 MHz		0.05		deg
Time Domain Response						
t_r	Rise Time	2V Step, 10% to 90%		1.7		ns
t_f	Fall Time	2V Step, 10% to 90%		1.4		ns
OS	Overshoot	2V Step		4		%
SR	Slew Rate	4 V_{PP} , 40% to 60% ⁽⁴⁾		1700		V/ μs
t_s	Settling Time	2V Step, V_{OUT} within 0.5%		9		ns
Distortion And Noise Response						
HD2	2 nd Harmonic Distortion	2 V_{PP} , 10 MHz		-76		dBc
HD3	3 rd Harmonic Distortion	2 V_{PP} , 10 MHz		-76		dBc
e_n	Input Referred Voltage Noise	>1 MHz		12		nV/ $\sqrt{\text{Hz}}$
i_n	Input Referred Noise Current	>1 MHz		2		pA/ $\sqrt{\text{Hz}}$
	Switching Time			16		ns
XTLK	Crosstalk	All Hostile, $f = 100\text{ MHz}$		-45		dBc
ISOL	Off Isolation	$f = 100\text{ MHz}$		-60		dBc
Static, DC Performance						
A_V	Gain		1.986	2.00	2.014	
V_{OS}	Output Offset Voltage			±3	±17	mV
TCV_{OS}	Output Offset Voltage Average Drift	⁽⁵⁾		38		$\mu\text{V}/^\circ\text{C}$
I_B	Input Bias Current	Non-Inverting ⁽⁶⁾		-5		μA
TCI_B	Input Bias Current Average Drift	Non-Inverting ⁽⁵⁾		-12		nA/ $^\circ\text{C}$
V_O	Output Voltage Range	$R_L = 100\Omega$	±1.75	±2.1		V

- (1) Electrical Table values apply only for factory testing conditions at the temperature indicated. No ensurance of parametric performance is indicated in the electrical tables under conditions different than those tested.
- (2) Room Temperature limits are 100% production tested at 25°C. Device self heating results in $T_J \geq T_A$, however, test time is insufficient for T_J to reach steady state conditions. Limits over the operating temperature range are ensured through correlation using Statistical Quality Control (SQC) methods.
- (3) Typical values represent the most likely parametric norm as determined at the time of characterization. Actual typical values may vary over time and will also depend on the application and configuration. The typical values are not tested and are not ensured on shipped production material.
- (4) Slew Rate is the average of the rising and falling edges.
- (5) Drift determined by dividing the change in parameter at temperature extremes by the total temperature change.
- (6) Negative input current implies current flowing out of the device.

±3.3V Electrical Characteristics ⁽¹⁾ (continued)

Unless otherwise specified, typical conditions are: $T_A = 25^\circ\text{C}$, $A_V = +2$, $V_S = \pm 3.3\text{V}$, $R_L = 100\Omega$; **Boldface** limits apply at the temperature extremes.

Symbol	Parameter	Conditions	Min ⁽²⁾	Typ ⁽³⁾	Max ⁽²⁾	Units
V_O	Output Voltage Range	$R_L = \infty$ ⁽⁷⁾	+2.1 -2.05	± 2.2		V
PSRR	Power Supply Rejection Ratio			45		dB
I_{CC}	Positive Supply Current	$R_L = \infty$		98	120	mA
I_{EE}	Negative Supply Current	$R_L = \infty$		92	115	mA
	Tri State Supply Current	RST Pin > 2.0V		17	25	mA
Miscellaneous Performance						
R_{IN}	Input Resistance	Non-Inverting		100		k Ω
C_{IN}	Input Capacitance	Non-Inverting		1		pF
R_O	Output Resistance Enabled	Closed Loop, Enabled		300		m Ω
R_O	Output Resistance Disabled	Disabled	1100	1300	1450	Ω
CMVR	Input Common Mode Voltage Range			± 1.3		V
I_O	Output Current	Sourcing, $V_O = 0\text{V}$		± 50		mA
Digital Control						
V_{IH}	Input Voltage High		2.0			V
V_{IL}	Input Voltage Low				0.8	V
V_{OH}	Output Voltage High			>2.2		V
V_{OL}	Output Voltage Low			<0.4		V
T_S	Setup Time			7		ns
T_H	Hold Time			7		ns

(7) This parameter is ensured by design and/or characterization and is not tested in production.

±5V Electrical Characteristics ⁽¹⁾

Unless otherwise specified, typical conditions are: $T_A = 25^\circ\text{C}$, $A_V = +2$, $V_S = \pm 5\text{V}$, $R_L = 100\Omega$; **Boldface** limits apply at the temperature extremes.

Symbol	Parameter	Conditions	Min ⁽²⁾	Typ ⁽³⁾	Max ⁽²⁾	Units
Frequency Domain Performance						
SSBW	-3 dB Bandwidth	$V_{OUT} = 0.5 V_{PP}$		475		MHz
LSBW		$V_{OUT} = 2 V_{PP}$, $R_L = 1\text{k}\Omega$		550		
		$V_{OUT} = 2 V_{PP}$, $R_L = 150\Omega$		450		
GF	0.1 dB Gain Flatness	$V_{OUT} = 2 V_{PP}$, $R_L = 150\Omega$		100		MHz
DG	Differential Gain	$R_L = 150\Omega$, 3.58 MHz/ 4.43 MHz		0.04		%
DP	Differential Phase	$R_L = 150\Omega$, 3.58 MHz/ 4.43 MHz		0.04		deg
Time Domain Response						
t_r	Rise Time	2V Step, 10% to 90%		1.4		ns
t_f	Fall Time	2V Step, 10% to 90%		1.3		ns
OS	Overshoot	2V Step		2		%
SR	Slew Rate	6 V_{PP} , 40% to 60% ⁽⁴⁾		1800		V/ μs
t_s	Settling Time	2V Step, V_{OUT} Within 0.5%		7		ns

- (1) Electrical Table values apply only for factory testing conditions at the temperature indicated. No assurance of parametric performance is indicated in the electrical tables under conditions different than those tested.
- (2) Room Temperature limits are 100% production tested at 25°C . Device self heating results in $T_J \geq T_A$, however, test time is insufficient for T_J to reach steady state conditions. Limits over the operating temperature range are ensured through correlation using Statistical Quality Control (SQC) methods.
- (3) Typical values represent the most likely parametric norm as determined at the time of characterization. Actual typical values may vary over time and will also depend on the application and configuration. The typical values are not tested and are not ensured on shipped production material.
- (4) Slew Rate is the average of the rising and falling edges.

±5V Electrical Characteristics ⁽¹⁾ (continued)

Unless otherwise specified, typical conditions are: $T_A = 25^\circ\text{C}$, $A_V = +2$, $V_S = \pm 5\text{V}$, $R_L = 100\Omega$; **Boldface** limits apply at the temperature extremes.

Symbol	Parameter	Conditions	Min ⁽²⁾	Typ ⁽³⁾	Max ⁽²⁾	Units
Distortion And Noise Response						
HD2	2 nd Harmonic Distortion	2 V_{PP} , 5 MHz		-80		dBc
HD3	3 rd Harmonic Distortion	2 V_{PP} , 5 MHz		-70		dBc
e_n	Input Referred Voltage Noise	>1 MHz		12		nV/ $\sqrt{\text{Hz}}$
i_n	Input Referred Noise Current	>1 MHz		2		pA/ $\sqrt{\text{Hz}}$
	Switching Time			15		ns
XTLK	Cross Talk	All Hostile, $f = 100\text{ MHz}$		-45		dBc
		Channel to Channel, $f = 100\text{ MHz}$		-52		dBc
ISOL	Off Isolation	$f = 100\text{ MHz}$		-65		dBc
Static, DC Performance						
A_V	Gain	LMH6583	1.986	2.00	2.014	
V_{OS}	Offset Voltage	Input Referred		±2	±17	mV
TCV_{OS}	Output Offset Voltage Average Drift	⁽⁵⁾		38		$\mu\text{V}/^\circ\text{C}$
I_B	Input Bias Current	Non-Inverting ⁽⁶⁾		-5	-12	μA
TCI_B	Input Bias Current Average Drift	Non-Inverting ⁽⁵⁾		-12		nA/ $^\circ\text{C}$
V_O	Output Voltage Range	$R_L = 100\Omega$	+3.3 -3.4	±3.6		V
V_O	Output Voltage Range	$R_L = \infty$	±3.7	±3.9		V
PSRR	Power Supply Rejection Ratio	DC	42	45		dB
XTLK	DC Crosstalk	DC, Channel to Channel	-58	-90		dB
ISOL	DC Off Isolation	DC	-60	-90		dB
I_{CC}	Positive Supply Current	$R_L = \infty$		110	130	mA
I_{EE}	Negative Supply Current	$R_L = \infty$		104	124	mA
	Tri State Supply Current	RST Pin > 2.0V		22	30	mA
Miscellaneous Performance						
R_{IN}	Input Resistance	Non-Inverting		100		k Ω
C_{IN}	Input Capacitance	Non-Inverting		1		pF
R_O	Output Resistance Enabled	Closed Loop, Enabled		300		m Ω
R_O	Output Resistance Disabled	Disabled, Resistance to Ground	1100	1300	1450	Ω
CMVR	Input Common Mode Voltage Range			±3.0		V
I_O	Output Current	Sourcing, $V_O = 0\text{ V}$	±60	±70		mA
Digital Control						
V_{IH}	Input Voltage High		2.0			V
V_{IL}	Input Voltage Low				0.8	V
V_{OH}	Output Voltage High			>2.4		V
V_{OL}	Output Voltage Low			<0.4		V
T_S	Setup Time			5		ns
T_H	Hold Time			5		ns

(5) Drift determined by dividing the change in parameter at temperature extremes by the total temperature change.

(6) Negative input current implies current flowing out of the device.

Typical Performance Characteristics

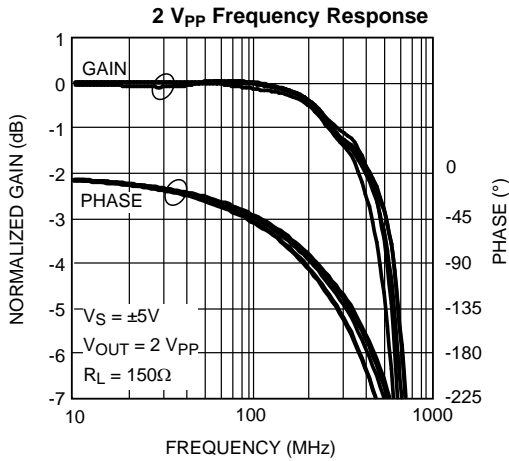

Figure 3.

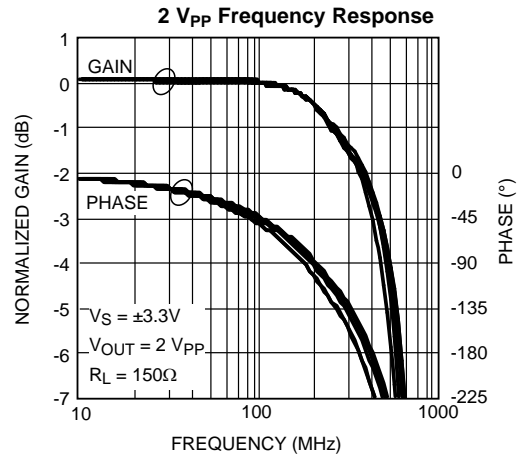

Figure 4.

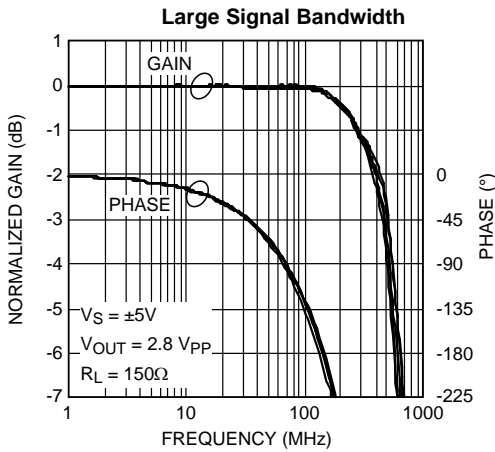

Figure 5.

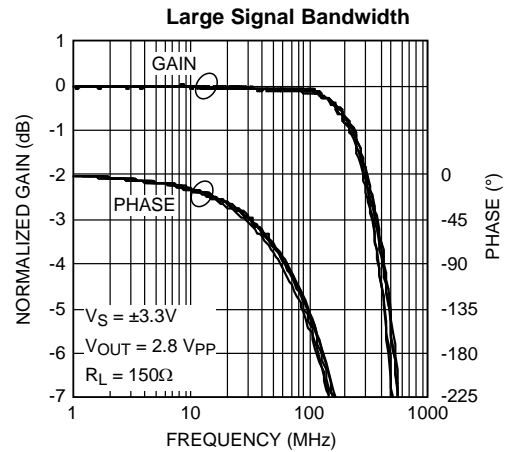

Figure 6.

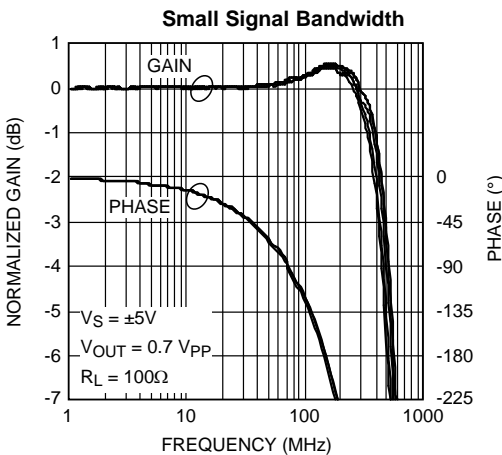

Figure 7.

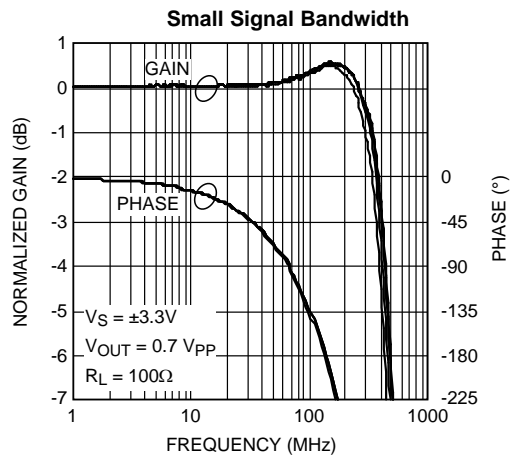

Figure 8.

Typical Performance Characteristics (continued)

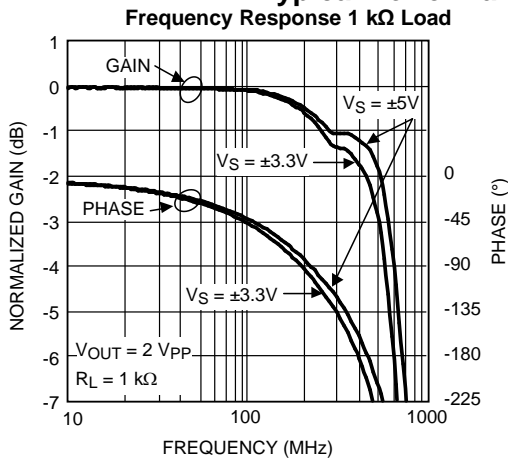

Figure 9.

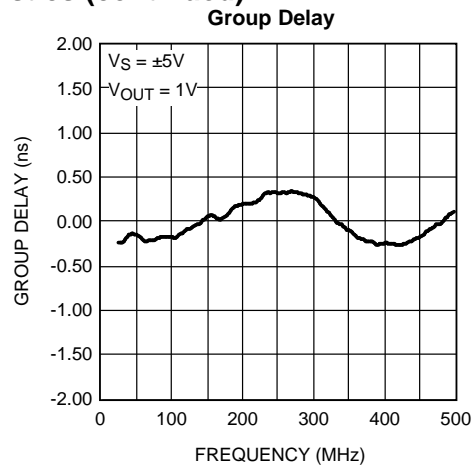

Figure 10.

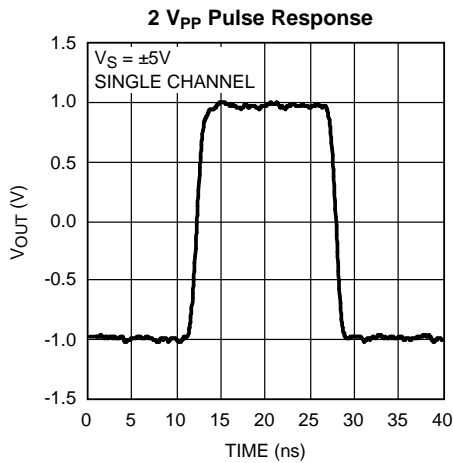

Figure 11.

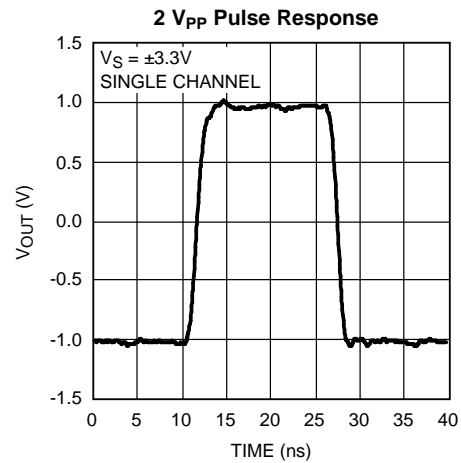

Figure 12.

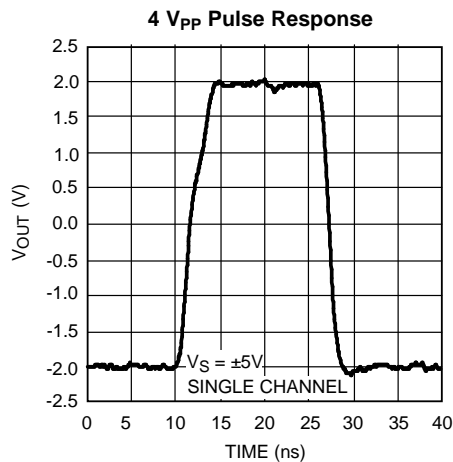

Figure 13.

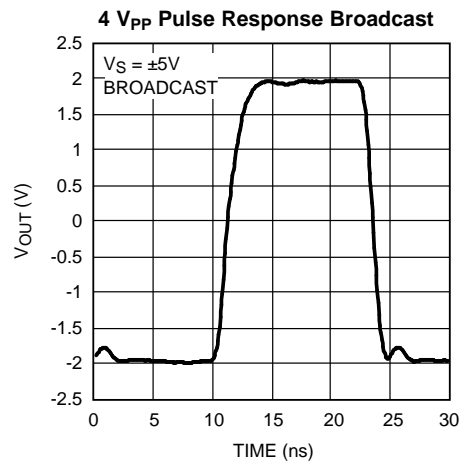

Figure 14.

Typical Performance Characteristics (continued)

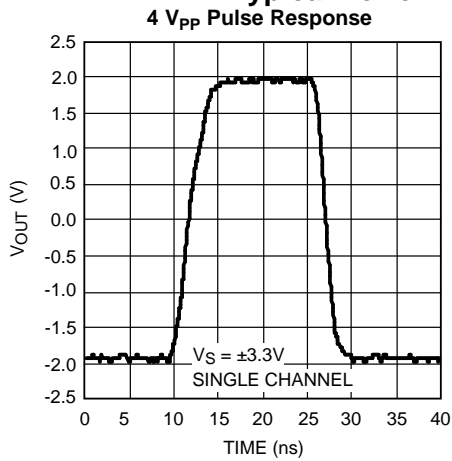

Figure 15.

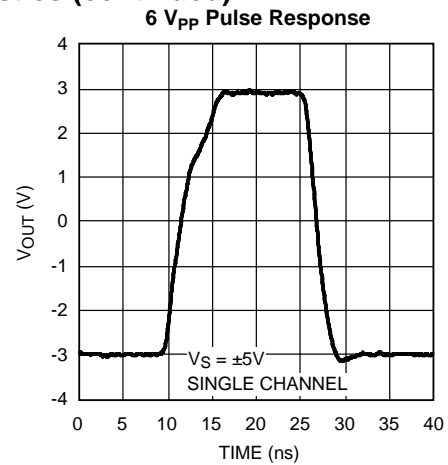

Figure 16.

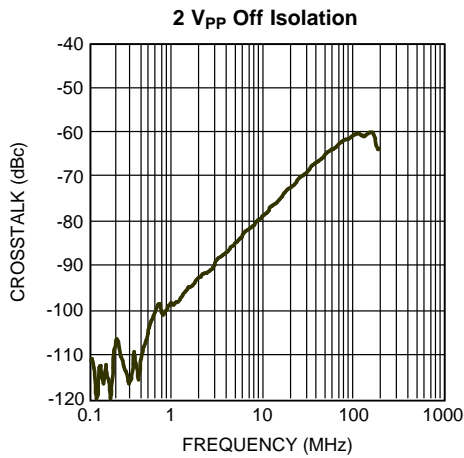

Figure 17.

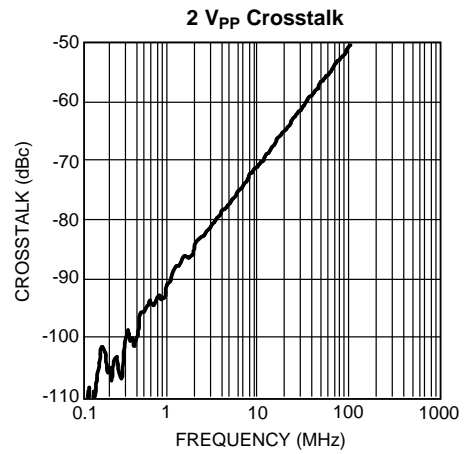

Figure 18.

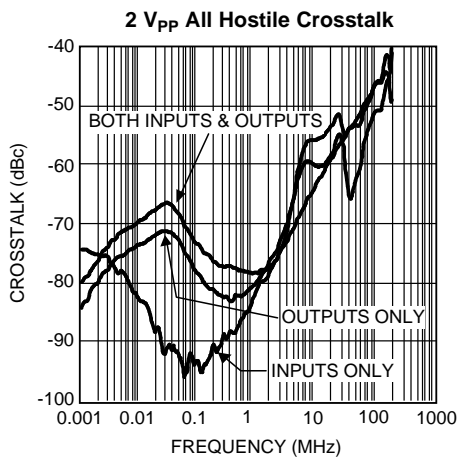

Figure 19.

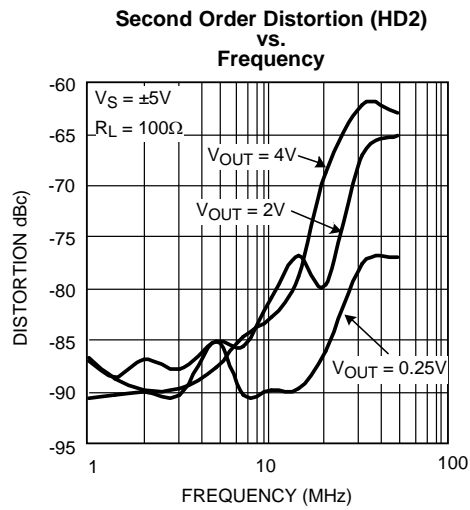

Figure 20.

Typical Performance Characteristics (continued)

Third Order Distortion (HD3) vs. Frequency

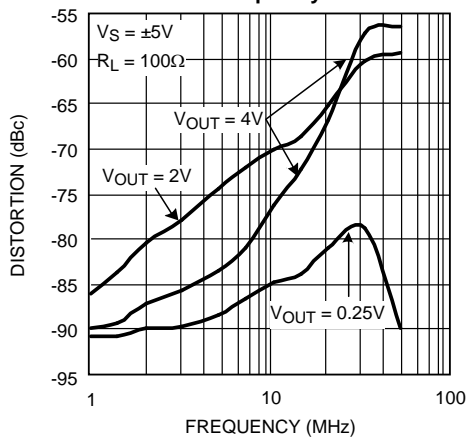

Figure 21.

Second Order Distortion vs. Frequency

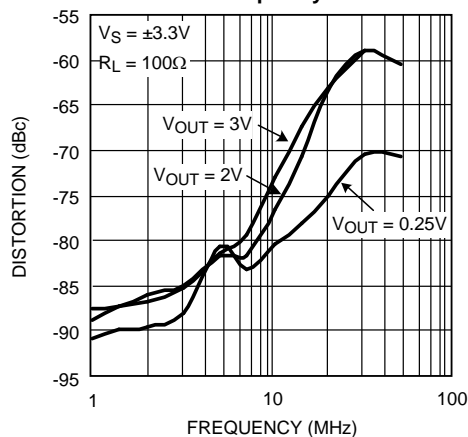

Figure 22.

Third Order Distortion vs. Frequency

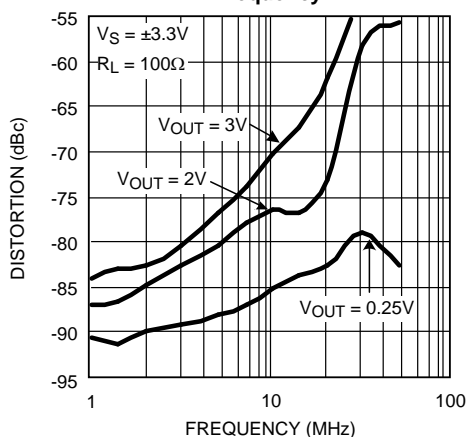

Figure 23.

No Load Output Swing

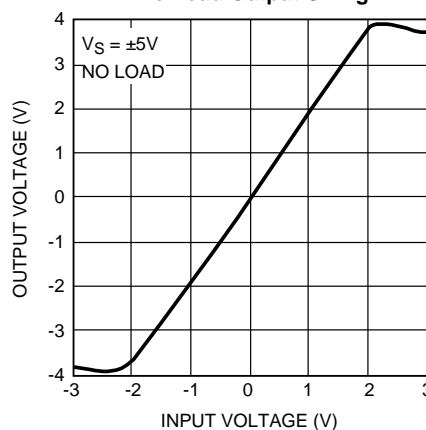

Figure 24.

Positive Swing over Temperature

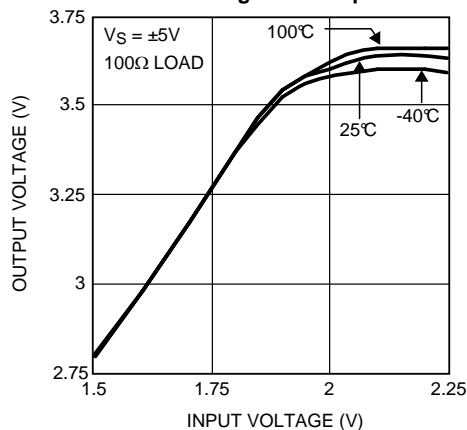

Figure 25.

Negative Swing Over Temperature

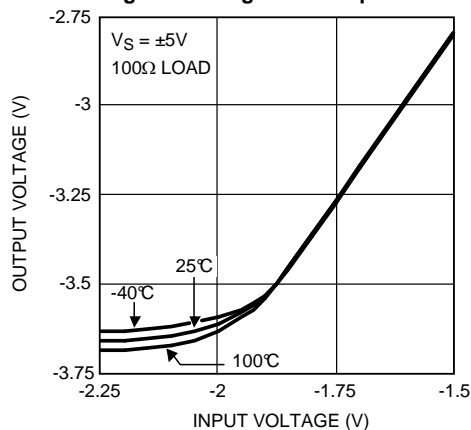

Figure 26.

Typical Performance Characteristics (continued)

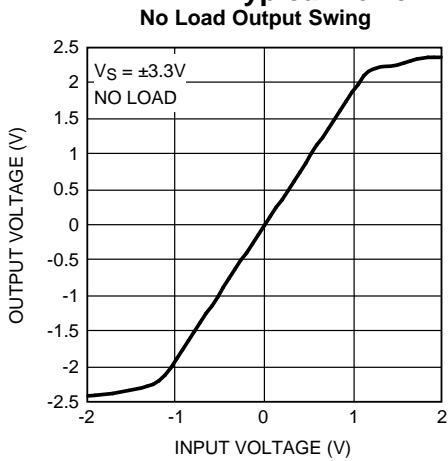

Figure 27.

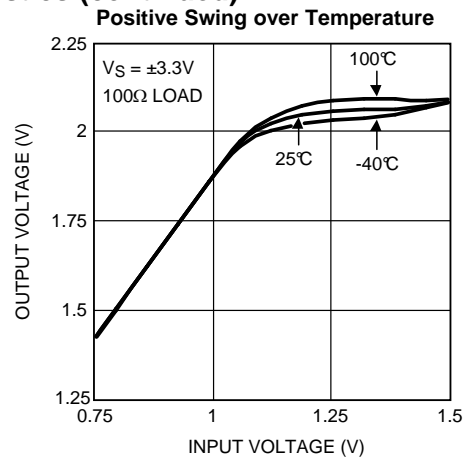

Figure 28.

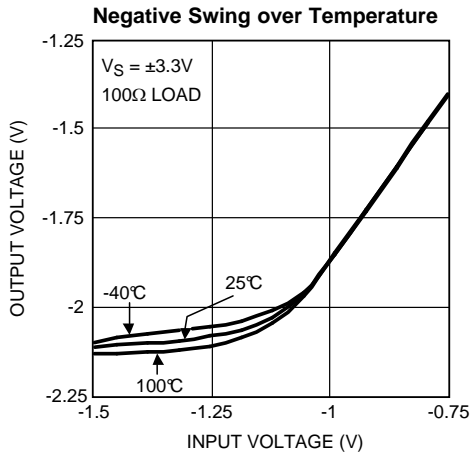

Figure 29.

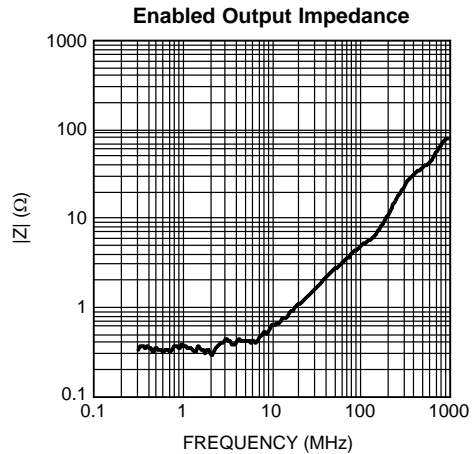

Figure 30.

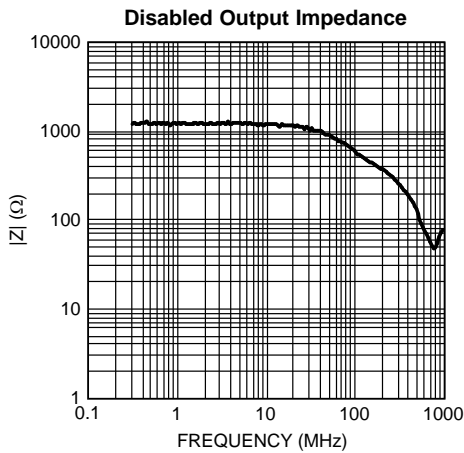

Figure 31.

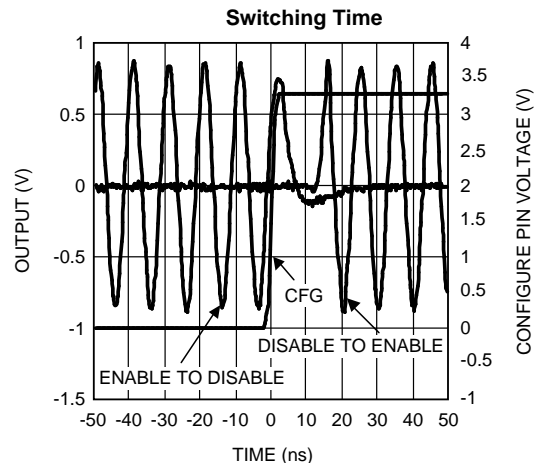

Figure 32.

APPLICATION INFORMATION

INTRODUCTION

The LMH6583 is a high speed, fully buffered, non blocking, analog crosspoint switch. Having fully buffered inputs allows the LMH6583 to accept signals from low or high impedance sources without the worry of loading the signal source. The fully buffered outputs will drive 75Ω or 50Ω back terminated transmission lines with no external components other than the termination resistor. When disabled, the outputs are in a high impedance state. The LMH6583 can have any input connected to any (or all) output(s). Conversely, a given output can have only one associated input.

INPUT AND OUTPUT EXPANSION

The LMH6583 has high impedance inactive states for both inputs and outputs allowing maximum flexibility for Crosspoint expansion. In addition the LMH6583 employs diagonal symmetry in pin assignments. The diagonal symmetry makes it easy to use direct pin to pin vias when the parts are mounted on opposite sides of a board. As an example two LMH6583 chips can be combined on one board to form either a 16 x 16 crosspoint or a 32 x 8 crosspoint. To make a 16 x 16 cross-point all 16 input pins would be tied together (Input 0 on side 1 to input 15 on side 2 and so on) while the 8 output pins on each chip would be left separate. To make the 32 x 8 crosspoint, the 8 outputs would be tied together while all 32 inputs would remain independent. In the 32 x 8 configuration it is important not to have 2 connected outputs active at the same time. With the 16 x 16 configuration, on the other hand, having two connected inputs active is a valid state. Crosspoint expansion as detailed above has the advantage that the signal path has only one crosspoint in it at a time. Expansion methods that have cascaded stages will suffer bandwidth loss far greater than the small loading effect of parallel expansion.

Output expansion is very straight forward. Connecting the inputs of two crosspoint switches has a very minor impact on performance. Input expansion requires more planning. As shown in Figure 34 and Figure 35 there are two ways to connect the outputs of the crosspoint switches. In Figure 34 the crosspoint switch outputs are connected directly together and share one termination resistor. This is the easiest configuration to implement and has only one drawback. Because the disabled output of the unused crosspoint (only one output can be active at a time) has a small amount of capacitance the frequency response of the active crosspoint will show peaking. This is illustrated in Figure 36 and Figure 37. In most cases this small amount of peaking is not a problem.

As illustrated in Figure 35 each crosspoint output can be given its own termination resistor. This results in a frequency response nearly identical to the non expansion case. There is one drawback for the gain of 2 crosspoint, and that is gain error. With a 75Ω termination resistor the 1250Ω resistance of the disabled crosspoint output will cause a gain error. In order to counter act this the termination resistors of both crosspoints should be adjusted to approximately 71Ω. This will provide very good matching, but the gain accuracy of the system will now be dependent on the process variations of the crosspoint resistors which have a variability of approximately ±20%.

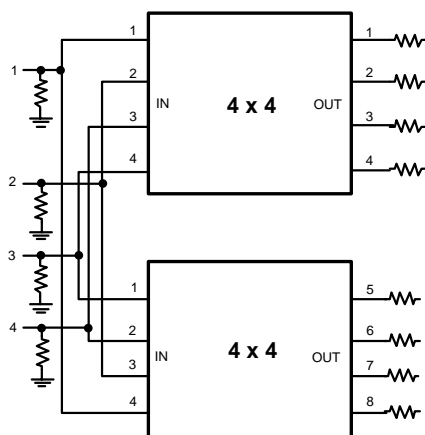

Figure 33. Output Expansion

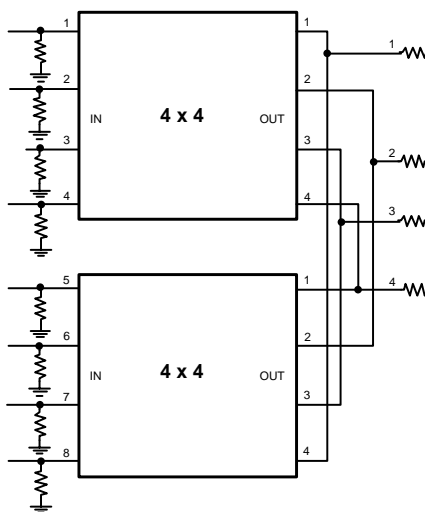

Figure 34. Input Expansion with Shared Termination Resistors

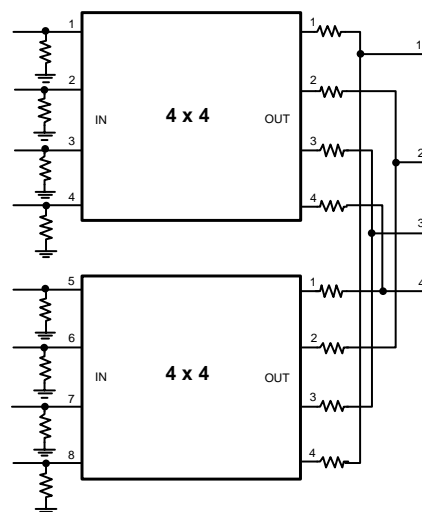

Figure 35. Input Expansion with Separate Termination Resistors

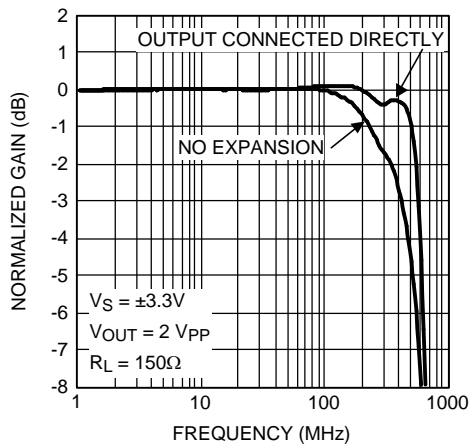

Figure 36. Input Expansion Frequency Response

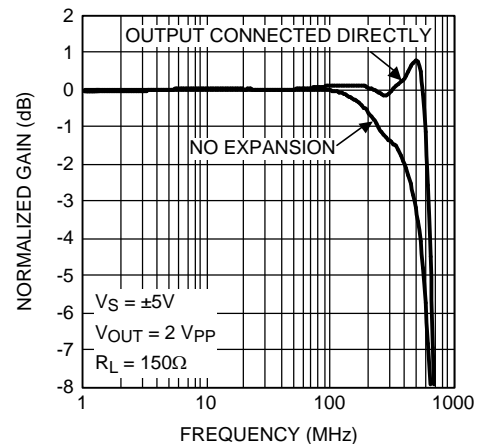

Figure 37. Input Expansion Frequency Response

DRIVING CAPACITIVE LOADS

Capacitive output loading applications will benefit from the use of a series output resistor R_{OUT} . Capacitive loads of 5 pF to 120 pF are the most critical, causing ringing, frequency response peaking and possible oscillation. For applications where maximum frequency response is needed and some peaking is tolerable, the value of R_{OUT} can be reduced slightly from the recommended values. When driving transmission lines the 50Ω or 75Ω matching resistor makes the series output resistor unnecessary.

USING OUTPUT BUFFERING TO ENHANCE BANDWIDTH AND INCREASE RELIABILITY

The LMH6583 crosspoint switch can offer enhanced bandwidth and reliability with the use of external buffers on the outputs. The bandwidth is increased by unloading the outputs and driving a higher impedance. The 1 kΩ load resistor was chosen to provide the best performance on our evaluation board. See [Figure 9](#) in [Typical Performance Characteristics](#) for an example of bandwidth achieved with less loading on the outputs. For this technique to provide maximum benefit a very high speed amplifier such as the LMH6703 should be used, as shown in [Figure 38](#).

Besides offering enhanced bandwidth performance using an external buffer provides for greater system reliability. The first advantage is to reduce thermal loading on the crosspoint switch. This reduced die temperature will increase the life of the crosspoint. The second advantage is enhanced ESD reliability. It is very difficult to build high speed devices that can withstand all possible ESD events. With external buffers the crosspoint switch is isolated from ESD events on the external system connectors.

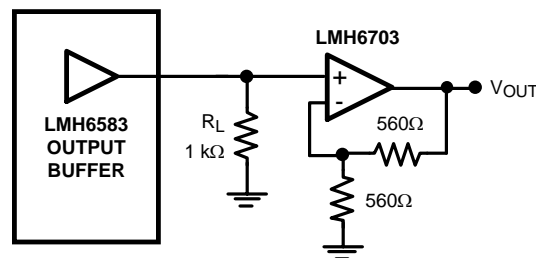

Figure 38. Buffered Output

In the example in [Figure 38](#), the resistor R_L is required to provide a load for the crosspoint output buffer. Without R_L excessive frequency response peaking is likely and settling times of transient signals will be poor. As the value of R_L is reduced the bandwidth will also go down. The amplifier shown in the example is an LMH6703 this amplifier offers high speed and flat bandwidth. Another suitable amplifiers is the LMH6702. The LMH6702 is a faster amplifier that can be used to generate high frequency peaking in order to equalize longer cable lengths. If board space is at a premium the LMH6739 or the LMH6734 are triple, selectable gain buffers which require no external resistors.

CROSSTALK

When designing a large system such as a video router crosstalk can be a very serious problem. Extensive testing in our lab has shown that most crosstalk is related to board layout rather than occurring in the crosspoint switch. There are many ways to reduce board related crosstalk. Using controlled impedance lines is an important step. Using well decoupled power and ground planes will help as well. When crosstalk does occur within the crosspoint switch itself it is often due to signals coupling into the power supply pins. Using appropriate supply bypassing will help to reduce this mode of coupling. Another suggestion is to place as much grounded copper as possible between input and output signal traces. Care must be taken, though, not to influence the signal trace impedances by placing shielding copper too closely. One other caveat to consider is that as shielding materials come closer to the signal trace the trace needs to be smaller to keep the impedance from falling too low. Using thin signal traces will result in unacceptable losses due to trace resistance. This effect becomes even more pronounced at higher frequencies due to the skin effect. The skin effect reduces the effective thickness of the trace as frequency increases. Resistive losses make crosstalk worse because as the desired signal is attenuated with higher frequencies crosstalk increases at higher frequencies.

DIGITAL CONTROL

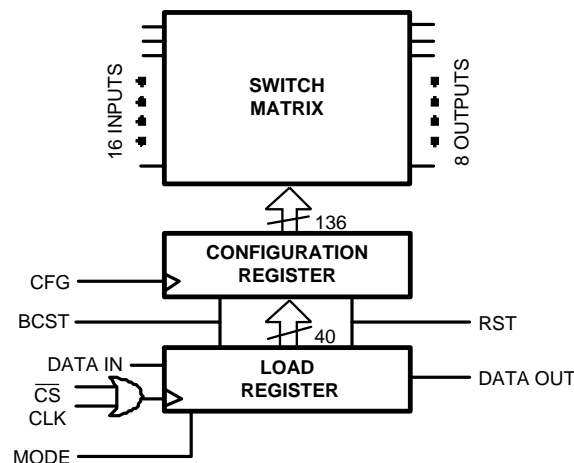

Figure 39. Block Diagram

The LMH6583 has internal control registers that store the programming states of the crosspoint switch. The logic is two staged to allow for maximum programming flexibility. The first stage of the control logic is tied directly to the crosspoint switching matrix. This logic consists of one register for each output that stores the on/off state and the address of which input to connect to. These registers are not directly accessible by the user. The second level of logic is another bank of registers identical to the first, but set up as shift registers. These registers are accessed by the user via the serial input bus. As described further below, there are two modes for programming the LMH6582, [SERIAL PROGRAMMING MODE](#) and [ADDRESSED PROGRAMMING MODE](#).

The LMH6583 is programmed via a serial input bus with the support of 4 other digital control pins. The Serial bus consists of a clock pin (CLK), a serial data in pin (DIN), and a serial data out pin (D_{OUT}). The serial bus is gated by a chip select pin (CS). The chip select pin is active low. While the chip select pin is high all data on the serial input pin and clock pins is ignored. When the chip select pin is brought low the internal logic is set to begin receiving data by the first positive transition (0 to 1) of the clock signal. The chip select pin must be brought low at least 5 ns before the first rising edge of the clock signal. The first data bit is clocked in on the next negative

transition (1 to 0) of the clock signal. All input data is read from the bus on the negative edge of the clock signal. Once the last valid data has been clocked in, the chip select pin must go high then the clock signal must make at least one more low to high transition. Otherwise invalid data will be clocked into the chip. The data clocked into the chip is not transferred to the crosspoint matrix until the CFG pin is pulsed high. This is the case regardless of the state of the Mode pin. The CFG pin is not dependent on the state of the Chip select pin. If no new data is clocked into the chip subsequent pulses on the CFG pin will have no effect on device operation.

The programming format of the incoming serial data is selected by the MODE pin. When the mode pin is HIGH the crosspoint can be programmed one output at a time by entering a string of data that contains the address of the output that is going to be changed (Addressed Mode). When the mode pin is LOW the crosspoint is in Serial Mode. In this mode the crosspoint accepts a 40 bit array of data that programs all of the outputs. In both modes the data fed into the chip does not change the chip operation until the Configure pin is pulsed high. The configure and mode pins are independent of the chip select pin.

THREE WIRE VS. FOUR WIRE CONTROL

There are two ways to connect the serial data pins. The first way is to control all 4 pins separately, and the second option is to connect the CFG and the CS pins together for a 3 wire interface. The benefit of the 4 wire interface is that the chip can be configured independently of the CS pin. This would be an advantage in a system with multiple crosspoint chips where all of them could be programmed ahead of time and then configured simultaneously. The 4 wire solution is also helpful in a system that has a free running clock on the CLK pin. In this case, the CS pin needs to be brought high after the last valid data bit to prevent invalid data from being clocked into the chip.

The three wire option provides the advantage of one less pin to control at the expense of having less flexibility with the configure pin. One way around this loss of flexibility would be if the clock signal is generated by an FPGA or microcontroller where the clock signal can be stopped after the data is clocked in. In this case the Chip select function is provided by the presence or absence of the clock signal.

SERIAL PROGRAMMING MODE

Serial programming mode is the mode selected by bringing the MODE pin low. In this mode a stream of 40 bits programs all 8 outputs of the crosspoint. The data is fed to the chip as shown in [Table 1](#) through [Table 4](#) (4 tables are required to show the entire data frame). The table is arranged such that the first bit clocked into the crosspoint register is labeled bit number 0. The register labeled Load Register in [Figure 39](#) is a shift register. If the chip select pin is left low after the valid data is shifted into the chip and if the clock signal keeps running then additional data will be shifted into the register, and the desired data will be shifted out.

Also illustrated is the timing relationships for the digital pins in [Figure 40](#). It is important to note that all the pin timing relationships are important, not just the data and clock pins. One example is that the Chip Select pin (CS) must transition low before the first rising edge of the clock signal. This allows the internal timing circuits to synchronize to allow data to be accepted on the next falling edge. After the final data bit has been clocked in, the chip select pin must go high, then the clock signal must make at least one more low to high transition. As shown in [Figure 40](#), the chip select pin state should always occur while the clock signal is low. The configure (CFG) pin timing is not so critical, but it does need to be kept low until all data has been shifted into the crosspoint registers.

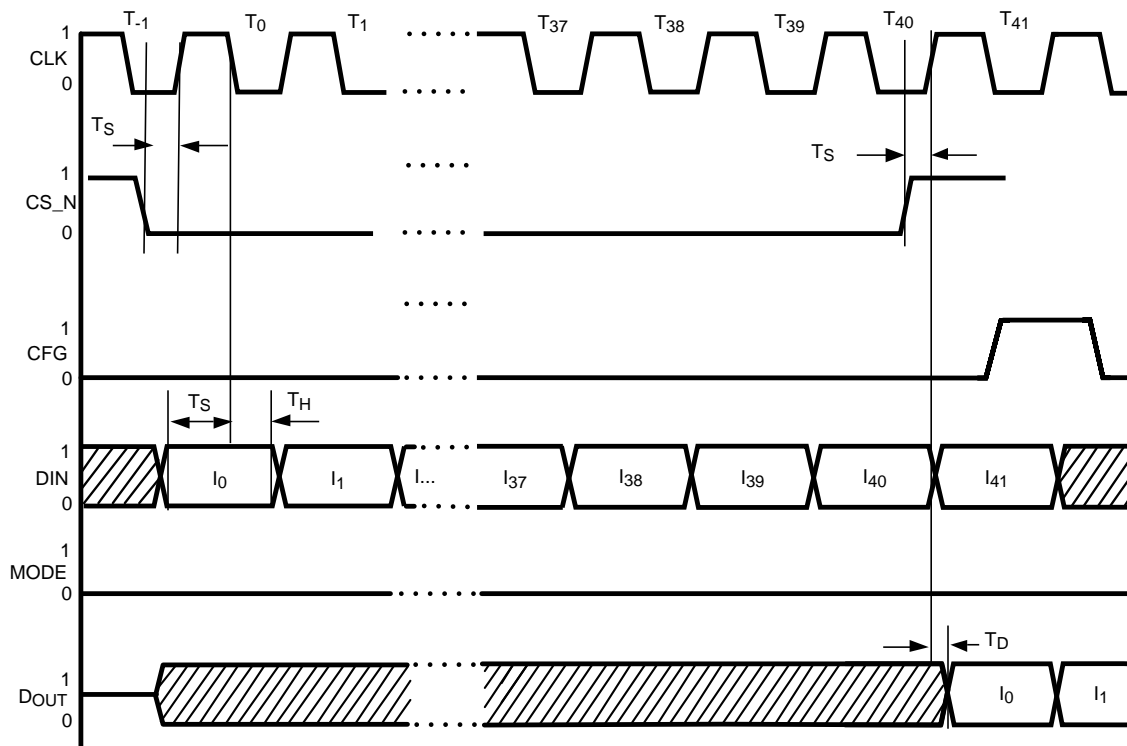

Figure 40. Timing Diagram for Serial Mode

Table 1. Serial Mode Data Frame (First 2 Words)⁽¹⁾

Output 0				Output 1					
Input Address				On = 0	Input Address				On = 0
LSB			MSB	Off = 1	LSB			MSB	Off = 1
0	1	2	3	4	5	6	7	8	9

(1) Off = TRI-STATE, Bit 0 is first bit clocked into device.

Table 2. Serial Mode Data Frame (Continued)

Output 2				Output 3					
Input Address				On = 0	Input Address				On = 0
LSB			MSB	Off = 1	LSB			MSB	Off = 1
10	11	12	13	14	15	16	17	18	19

Table 3. Serial Mode Data Frame (Continued)

Output 4				Output 5					
Input Address				On = 0	Input Address				On = 0
LSB			MSB	Off = 1	LSB			MSB	Off = 1
20	21	22	23	24	25	26	27	28	29

Table 4. Serial Mode Data Frame (Last 2 Words)⁽¹⁾

Output 6				Output 7					
Input Address				On = 0	Input Address				On = 0
LSB			MSB	Off = 1	LSB			MSB	Off = 1
30	31	32	33	34	35	36	37	38	39

(1) Bit 39 is last bit clocked into device.

ADDRESSED PROGRAMMING MODE

Addressed programming mode makes it possible to change only one output register at a time. To utilize this mode the mode pin must be High. All other pins function the same as in serial programming mode except that the word clocked in is 8 bits and is directed only at the output specified. In addressed mode the data format is shown in Table 5.

Also illustrated is the timing relationships for the digital pins in Figure 41. It is important to note that all the pin timing relationships are important, not just the data and clock pins. One example is that the Chip Select pin (CS) must transition low before the first rising edge of the clock signal. This allows the internal timing circuits to synchronize to allow data to be accepted on the next falling edge. After the final data bit has been clocked in, the chip select pin must go high, then the clock signal must make at least one more low to high transition. As shown in Figure 41, the chip select pin state should always occur while the clock signal is low. The configure (CFG) pin timing is not so critical, but it does need to be kept low until all data has been shifted into the crosspoint registers.

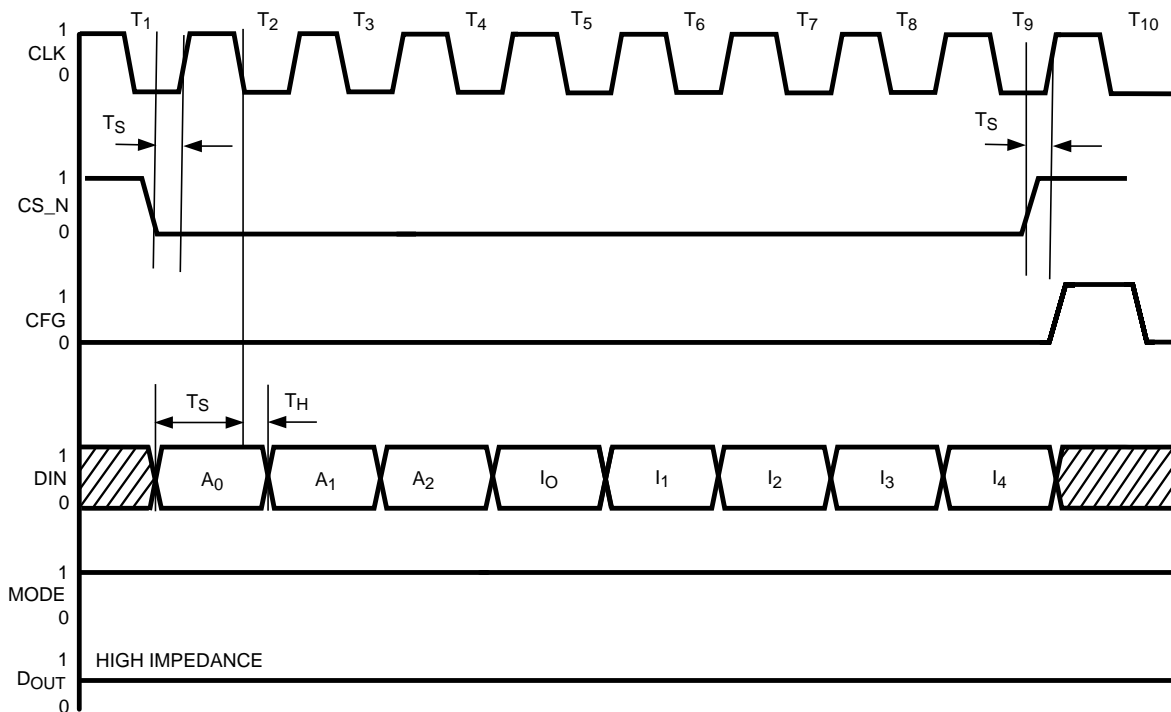

Figure 41. Timing Diagram for Addressed Mode

Table 5. Addressed Mode Word Format⁽¹⁾

Output Address			Input Address				TRI-STATE
LSB		MSB	LSB			MSB	1 = TRI-STATE 0 = On
0	1	2	3	4	5	6	7

(1) Bit 0 is first bit clocked into device.

DAISY CHAIN OPTION IN SERIAL MODE

The LMH6583 supports daisy chaining of the serial data stream between multiple chips. This feature is available only in the Serial programming mode. To use this feature serial data is clocked into the first chip DIN pin, and the next chip DIN pin is connected to the DOUT pin of the first chip. Both chips may share a chip select signal, or the second chip can be enabled separately. When the chip select pin goes low on both chips a double length word is clocked into the first chip. As the first word is clocking into the first chip the second chip is receiving the data that was originally in the shift register of the first chip (invalid data). When a full 40 bits have been clocked into the first chip the next clock cycle begins moving the first frame of the new configuration data into the second chip. With a full 80 clock cycles both chips have valid data and the chip select pin of both chips should be brought high to prevent the data from overshooting. A configure pulse will activate the new configuration on both chips simultaneously, or each chip can be configured separately. The mode, chip select, configure and clock pins of both chips can be tied together and driven from the same sources.

SPECIAL CONTROL PINS

The LMH6583 has two special control pins that function independent of the serial control bus. One of these pins is the reset (RST) pin. The RST pin is active high meaning that a logic 1 level the chip is configured with all outputs disabled and in a high impedance state. The RST pin programs all the registers with input address 0 and all the outputs are turned off. In this configuration the device draws only 20 mA. The reset pin can be used as a shutdown function to reduce power consumption. The other special control pin is the broadcast (BCST) pin. The BCST pin is also active high and sets all the outputs to the on state connected to input 0. Both of these pins are level sensitive and require no clock signal. The two special control pins overwrite the contents of the configuration register.

THERMAL MANAGEMENT

The LMH6583 is packaged in a thermally enhanced Quad Flat Pack package. Even so, it is a high performance device that produces a significant amount of heat. With a $\pm 5V$ supply, the LMH6583 will dissipate approximately 1.1W of idling power with all outputs enabled. Idling power is calculated based on the typical supply current of 110 mA and a 10V supply voltage. This power dissipation will vary within the range of 800 mW to 1.4W due to process variations. In addition, each equivalent video load (150Ω) connected to the outputs should be budgeted 30 mW of power. For a typical application with one video load for each output this would be a total power of 1.14 W. With a typical θ_{JA} of 27°C/W this will result in the silicon being 31°C over the ambient temperature. A more aggressive application would be two video loads per output which would result in 1.38 W of power dissipation. This would result in a 37°C temperature rise. For heavier loading, the HTQFP package thermal performance can be significantly enhanced with an external heat sink and by providing for moving air ventilation. Also, be sure to calculate the increase in ambient temperature from all devices operating in the system case. Because of the high power output of this device, thermal management should be considered very early in the design process. Generous passive venting and vertical board orientation may avoid the need for fan cooling or heat sinks. Also, the LMH6583 can be operated with a $\pm 3.3V$ power supply. This will cut power dissipation substantially while only reducing bandwidth by about 10% ($2 V_{PP}$ output). The LMH6583 is fully characterized and factory tested at the $\pm 3.3V$ power supply condition for applications where reduced power is desired.

If a heat sink is desired AAVD/Thermalloy part # 375324B00035G is the proper size for the LMH6583 package. This heat sink comes with adhesive tape for ease in assembly. With natural convection the heat sink will reduce the θ_{JA} from 27°C/W to approximately 21°C/W . Using a fan will increase the effectiveness of the heat sink considerably. When doing thermal design it is important to note that everything from board layout to case material will impact the actual θ_{JA} of the device. The θ_{JA} specified in the datasheet is for a typical board layout.

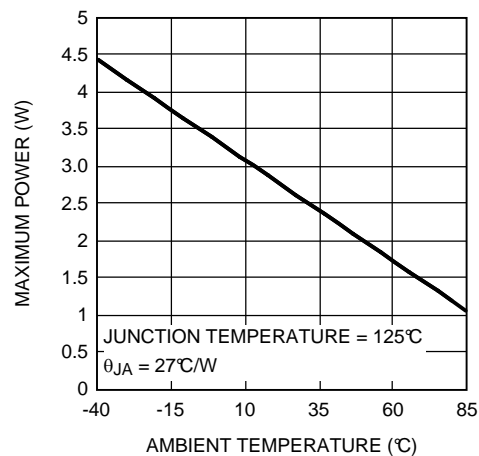

Figure 42. Maximum Dissipation vs. Ambient Temperature

PRINTED CIRCUIT LAYOUT

Generally, a good high frequency layout will keep power supply and ground traces away from the input and output pins. Parasitic capacitances on these nodes to ground will cause frequency response peaking and possible circuit oscillations (see [Application Note OA-15](#) for more information). If digital control lines must cross analog signal lines (particularly inputs) it is best if they cross perpendicularly. TI suggests the following evaluation boards as a guide for high frequency layout and as an aid in device testing and characterization:

Device	Package	Evaluation Board Part Number
LMH6583	64-Pin HTQFP	LMH730156

REVISION HISTORY

Changes from Revision D (March 2013) to Revision E	Page
<hr/> <ul style="list-style-type: none">• Changed layout of National Data Sheet to TI format	<hr/> 18

PACKAGING INFORMATION

Orderable Device	Status (1)	Package Type	Package Drawing	Pins	Package Qty	Eco Plan (2)	Lead/Ball Finish (6)	MSL Peak Temp (3)	Op Temp (°C)	Device Marking (4/5)	Samples
LMH6583YA/NOPB	ACTIVE	HTQFP	PAP	64	160	Green (RoHS & no Sb/Br)	NIPDAU	Level-3-260C-168 HR	-40 to 85	LMH6583YA	Samples

(1) The marketing status values are defined as follows:

ACTIVE: Product device recommended for new designs.

LIFEBUY: TI has announced that the device will be discontinued, and a lifetime-buy period is in effect.

NRND: Not recommended for new designs. Device is in production to support existing customers, but TI does not recommend using this part in a new design.

PREVIEW: Device has been announced but is not in production. Samples may or may not be available.

OBSELETE: TI has discontinued the production of the device.

(2) **RoHS:** TI defines "RoHS" to mean semiconductor products that are compliant with the current EU RoHS requirements for all 10 RoHS substances, including the requirement that RoHS substance do not exceed 0.1% by weight in homogeneous materials. Where designed to be soldered at high temperatures, "RoHS" products are suitable for use in specified lead-free processes. TI may reference these types of products as "Pb-Free".

RoHS Exempt: TI defines "RoHS Exempt" to mean products that contain lead but are compliant with EU RoHS pursuant to a specific EU RoHS exemption.

Green: TI defines "Green" to mean the content of Chlorine (Cl) and Bromine (Br) based flame retardants meet JS709B low halogen requirements of <=1000ppm threshold. Antimony trioxide based flame retardants must also meet the <=1000ppm threshold requirement.

(3) MSL, Peak Temp. - The Moisture Sensitivity Level rating according to the JEDEC industry standard classifications, and peak solder temperature.

(4) There may be additional marking, which relates to the logo, the lot trace code information, or the environmental category on the device.

(5) Multiple Device Markings will be inside parentheses. Only one Device Marking contained in parentheses and separated by a "~" will appear on a device. If a line is indented then it is a continuation of the previous line and the two combined represent the entire Device Marking for that device.

(6) Lead/Ball Finish - Orderable Devices may have multiple material finish options. Finish options are separated by a vertical ruled line. Lead/Ball Finish values may wrap to two lines if the finish value exceeds the maximum column width.

Important Information and Disclaimer:The information provided on this page represents TI's knowledge and belief as of the date that it is provided. TI bases its knowledge and belief on information provided by third parties, and makes no representation or warranty as to the accuracy of such information. Efforts are underway to better integrate information from third parties. TI has taken and continues to take reasonable steps to provide representative and accurate information but may not have conducted destructive testing or chemical analysis on incoming materials and chemicals. TI and TI suppliers consider certain information to be proprietary, and thus CAS numbers and other limited information may not be available for release.

In no event shall TI's liability arising out of such information exceed the total purchase price of the TI part(s) at issue in this document sold by TI to Customer on an annual basis.

THERMAL PAD MECHANICAL DATA

PAP (S-PQFP-G64)

PowerPAD™ PLASTIC QUAD FLATPACK

THERMAL INFORMATION

This PowerPAD™ package incorporates an exposed thermal pad that is designed to be attached to a printed circuit board (PCB). The thermal pad must be soldered directly to the PCB. After soldering, the PCB can be used as a heatsink. In addition, through the use of thermal vias, the thermal pad can be attached directly to the appropriate copper plane shown in the electrical schematic for the device, or alternatively, can be attached to a special heatsink structure designed into the PCB. This design optimizes the heat transfer from the integrated circuit (IC).

For additional information on the PowerPAD package and how to take advantage of its heat dissipating abilities, refer to Technical Brief, PowerPAD Thermally Enhanced Package, Texas Instruments Literature No. SLMA002 and Application Brief, PowerPAD Made Easy, Texas Instruments Literature No. SLMA004. Both documents are available at www.ti.com.

The exposed thermal pad dimensions for this package are shown in the following illustration.

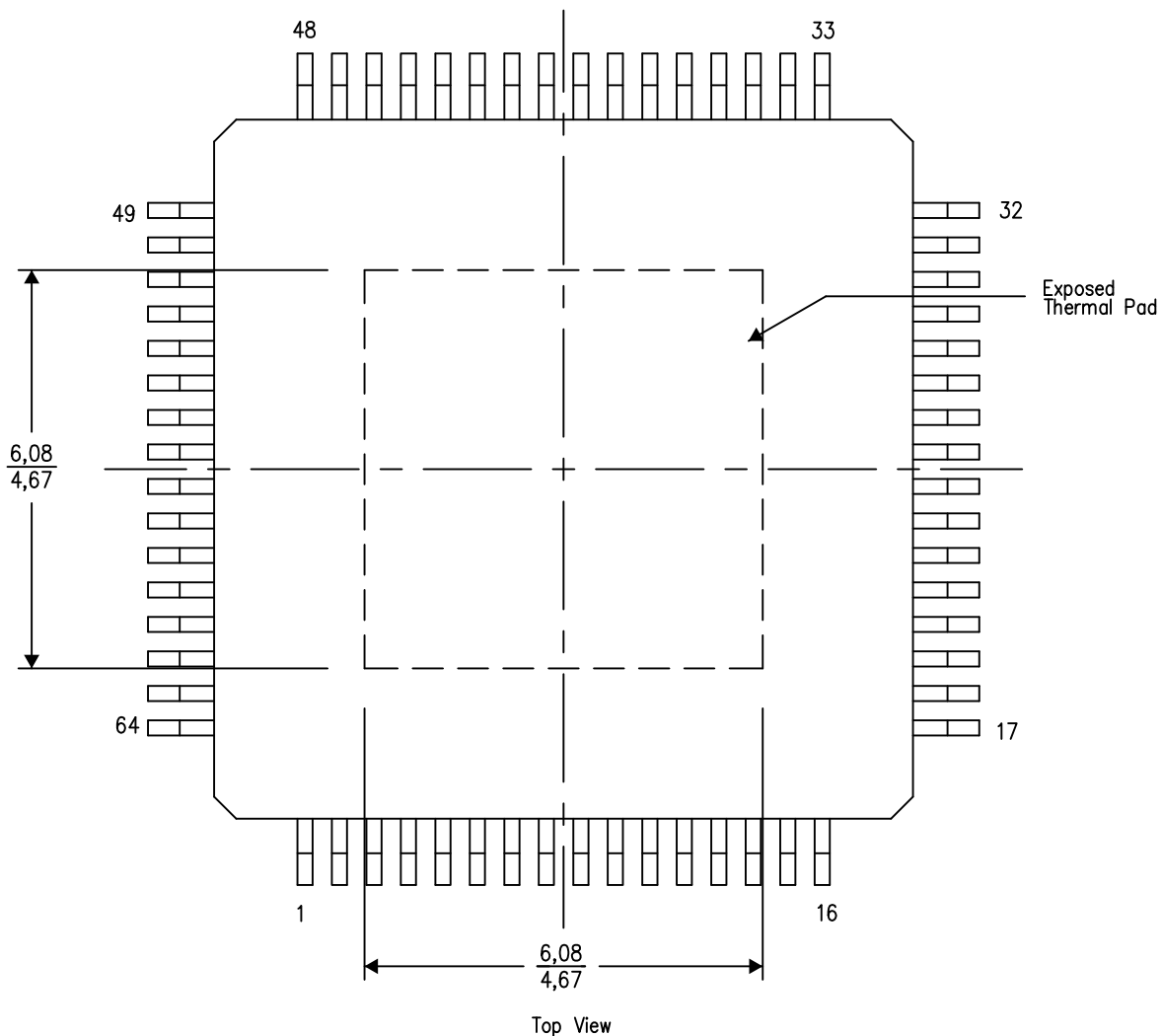

Exposed Thermal Pad Dimensions

4206326-6/P 05/14

NOTES: A. All linear dimensions are in millimeters

PowerPAD is a trademark of Texas Instruments

LAND PATTERN DATA

PAP (S-PQFP-G64)

PowerPAD™ PLASTIC QUAD FLATPACK

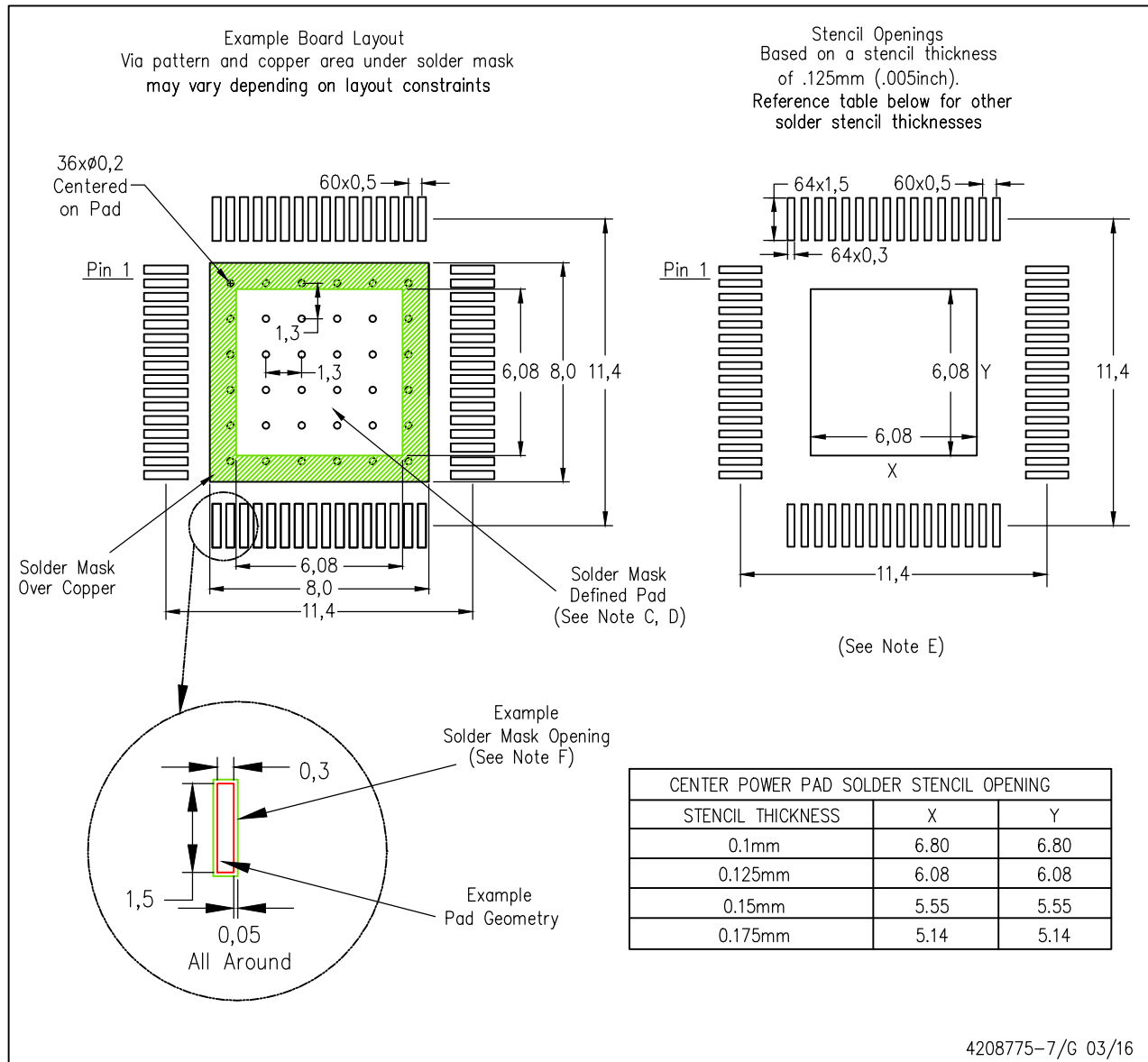

- NOTES:
- All linear dimensions are in millimeters.
 - This drawing is subject to change without notice.
 - Customers should place a note on the circuit board fabrication drawing not to alter the center solder mask defined pad.
 - This package is designed to be soldered to a thermal pad on the board. Refer to Technical Brief, PowerPad Thermally Enhanced Package, Texas Instruments Literature No. SLMA002, SLMA004, and also the Product Data Sheets for specific thermal information, via requirements, and recommended board layout. These documents are available at www.ti.com <<http://www.ti.com>>. Publication IPC-7351 is recommended for alternate designs.
 - Laser cutting apertures with trapezoidal walls and also rounding corners will offer better paste release. Customers should contact their board assembly site for stencil design recommendations. Example stencil design based on a 50% volumetric metal load solder paste. Refer to IPC-7525 for other stencil recommendations.
 - Customers should contact their board fabrication site for solder mask tolerances between and around signal pads.
- PowerPAD is a trademark of Texas Instruments**

IMPORTANT NOTICE AND DISCLAIMER

TI PROVIDES TECHNICAL AND RELIABILITY DATA (INCLUDING DATASHEETS), DESIGN RESOURCES (INCLUDING REFERENCE DESIGNS), APPLICATION OR OTHER DESIGN ADVICE, WEB TOOLS, SAFETY INFORMATION, AND OTHER RESOURCES "AS IS" AND WITH ALL FAULTS, AND DISCLAIMS ALL WARRANTIES, EXPRESS AND IMPLIED, INCLUDING WITHOUT LIMITATION ANY IMPLIED WARRANTIES OF MERCHANTABILITY, FITNESS FOR A PARTICULAR PURPOSE OR NON-INFRINGEMENT OF THIRD PARTY INTELLECTUAL PROPERTY RIGHTS.

These resources are intended for skilled developers designing with TI products. You are solely responsible for (1) selecting the appropriate TI products for your application, (2) designing, validating and testing your application, and (3) ensuring your application meets applicable standards, and any other safety, security, or other requirements. These resources are subject to change without notice. TI grants you permission to use these resources only for development of an application that uses the TI products described in the resource. Other reproduction and display of these resources is prohibited. No license is granted to any other TI intellectual property right or to any third party intellectual property right. TI disclaims responsibility for, and you will fully indemnify TI and its representatives against, any claims, damages, costs, losses, and liabilities arising out of your use of these resources.

TI's products are provided subject to TI's Terms of Sale (www.ti.com/legal/termsofsale.html) or other applicable terms available either on ti.com or provided in conjunction with such TI products. TI's provision of these resources does not expand or otherwise alter TI's applicable warranties or warranty disclaimers for TI products.

Mailing Address: Texas Instruments, Post Office Box 655303, Dallas, Texas 75265
Copyright © 2020, Texas Instruments Incorporated