

TPD2E009 2-Channel ESD Solution for High-Speed (6-Gbps) Differential Interface

1 Features

- Supports Data Rates up to 6 Gbps
- IEC 61000-4-2 ESD Protection
 - ± 8 -kV Contact Discharge
 - ± 8 -kV Air-Gap Discharge
- IEC 61000-4-5 Surge Protection
 - 5 A (8/20 μ s)
- Low Capacitance
 - DRT: 0.7-pF (Typ)
 - DBZ: 0.9-pF (Typ)
- 0.05-pF Matching Capacitance Between the Differential Signal Pair
- Dual-Matching TVS Diodes to Protect the Differential Data and Clock Lines of HDMI, LVDS, SATA, Ethernet, or USB Interfaces
- Space-Saving DRT and DBZ Package Options
- Flow-Through Pin Mapping for the High-Speed Lines Ensures Zero Additional Skew Due to Board Layout While Placing the ESD-Protection Chip Near the Connector

2 Applications

- End Equipment:
 - Notebooks
 - Set-Top Boxes
 - Portable Computers
 - DVD Players
 - Media Players
- Interfaces:
 - HDMI 2.0
 - USB 3.0
 - eSATA
 - Ethernet

3 Description

The TPD2E009 device provides two ESD protection diodes with flow-through pin mapping for ease of board layout. This device has been designed to protect sensitive components which are connected to ultra high-speed data and transmission lines. The TPD2E009 offers transient voltage suppression for Level 4 of IEC 61000-4-2 Contact ESD protection. TVS protection up to a 5-A (8/20 μ s) peak pulse-current rating per the IEC 61000-4-5 (lightning) specification is also provided.

The monolithic silicon technology allows matching between the differential signal pairs. The less than 0.05-pF differential capacitance ensures that the differential signal distortion due to added ESD circuit protection remains minimal. The low capacitance (0.7-pF) is suitable for high-speed data rates up to 6 Gbps.

The TPD2E009 TVS diode is offered in a DRT (1 mm \times 0.8 mm) package for space-saving portable applications. The industry standard DBZ (2.92 mm \times 1.3 mm) package offers additional flexibility in the board layout for the system designer.

Typical applications for the TPD2E009 line of ESD protection products are: HDMI, USB, eSATA, and ethernet interfaces in notebooks, DVD and media players, set-top boxes, and portable computers.

Device Information⁽¹⁾

PART NUMBER	PACKAGE	BODY SIZE (NOM)
TPD2E009	SOT (3)	2.92 mm \times 1.30 mm
		1.00 mm \times 0.80 mm

(1) For all available packages, see the orderable addendum at the end of the data sheet.

TPD2E009 Circuit

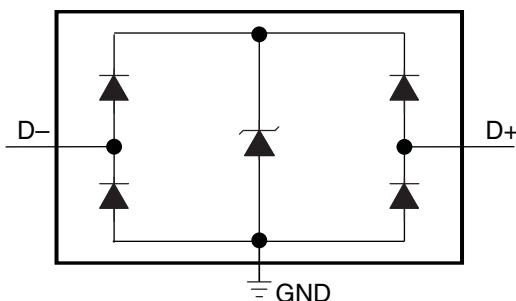

TPD2E009 Application Curve

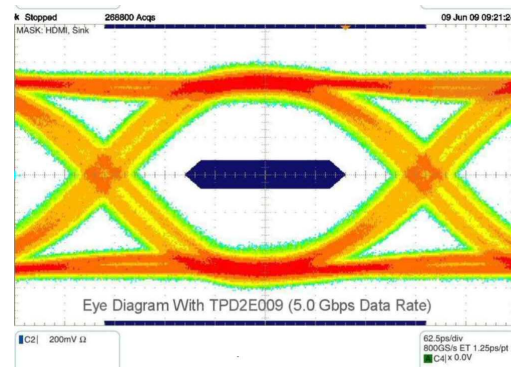

Table of Contents

1 Features	1	7.3 Feature Description	6
2 Applications	1	7.4 Device Functional Modes	6
3 Description	1	8 Application and Implementation	7
4 Revision History	2	8.1 Application Information	7
5 Pin Configuration and Functions	3	8.2 Typical Application	7
6 Specifications	3	9 Power Supply Recommendations	9
6.1 Absolute Maximum Ratings	3	10 Layout	9
6.2 ESD Ratings	3	10.1 Layout Guidelines	9
6.3 Recommended Operating Conditions	3	10.2 Layout Examples	9
6.4 Thermal Information	4	11 Device and Documentation Support	11
6.5 Electrical Characteristics	4	11.1 Community Resources	11
6.6 Typical Characteristics	5	11.2 Trademarks	11
7 Detailed Description	6	11.3 Electrostatic Discharge Caution	11
7.1 Overview	6	11.4 Glossary	11
7.2 Functional Block Diagram	6	12 Mechanical, Packaging, and Orderable Information	11

4 Revision History

NOTE: Page numbers for previous revisions may differ from page numbers in the current version.

Changes from Revision A (June 2009) to Revision B

Page

- Added *Pin Configuration and Functions* section, *ESD Ratings* table, *Feature Description* section, *Device Functional Modes*, *Application and Implementation* section, *Power Supply Recommendations* section, *Layout* section, *Device and Documentation Support* section, and *Mechanical, Packaging, and Orderable Information* section **1**

5 Pin Configuration and Functions

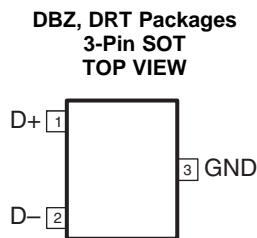

Pin Functions

PIN		TYPE	DESCRIPTION
NAME	NO.		
D+	1	ESD port	High-speed ESD clamp provides ESD protection to the high-speed differential data lines
D-	2		
GND	3	GND	Ground

6 Specifications

6.1 Absolute Maximum Ratings⁽¹⁾

over operating free-air temperature range (unless otherwise noted)

	MIN	MAX	UNIT
Operating temperature	-40	85	°C
I/O voltage tolerance	0	6	V
Peak pulse current ($t_p = 8/20 \mu\text{s}$)		5	A
Peak pulse power ($t_p = 8/20 \mu\text{s}$)		45	W
Storage temperature, T_{stg}	-65	125	°C

(1) Stresses beyond those listed under *Absolute Maximum Ratings* may cause permanent damage to the device. These are stress ratings only, and functional operation of the device at these or any other conditions beyond those indicated in the operational sections of the specifications is not implied. Exposure to absolute maximum-rated conditions for extended periods may affect device reliability.

6.2 ESD Ratings

	VALUE	UNIT
$V_{\text{(ESD)}}$ Electrostatic discharge	Human body model (HBM), per ANSI/ESDA/JEDEC JS-001 ⁽¹⁾	±15000
	Charged-device model (CDM), per JEDEC specification JESD22-C101 ⁽²⁾	±1000
	IEC 61000-4-2 contact discharge	D+, D- pins ±8000
	IEC 61000-4-2 air-gap discharge	D+, D- pins ±8000

(1) JEDEC document JEP155 states that 500-V HBM allows safe manufacturing with a standard ESD control process.

(2) JEDEC document JEP157 states that 250-V CDM allows safe manufacturing with a standard ESD control process.

6.3 Recommended Operating Conditions

over operating free-air temperature range (unless otherwise noted)

	MIN	NOM	MAX	UNIT
Operating free-air temperature, T_A	-40		85	°C
Operating voltage	0		5.5	V

6.4 Thermal Information

THERMAL METRIC ⁽¹⁾		TPD2E009		UNIT
		DBZ (SOT)	DRT (SOT)	
		3 PINS	3 PINS	
$R_{\theta JA}$	Junction-to-ambient thermal resistance	461.8	610	°C/W
$R_{\theta JC(top)}$	Junction-to-case (top) thermal resistance	216.2	288	°C/W
$R_{\theta JB}$	Junction-to-board thermal resistance	195.6	118.4	°C/W
ψ_{JT}	Junction-to-top characterization parameter	70.1	20.2	°C/W
ψ_{JB}	Junction-to-board characterization parameter	193.7	116.4	°C/W

(1) For more information about traditional and new thermal metrics, see the *Semiconductor and IC Package Thermal Metrics* application report, [SPRA953](#).

6.5 Electrical Characteristics

over operating free-air temperature range (unless otherwise noted)

PARAMETER		TEST CONDITIONS		MIN	TYP	MAX	UNIT
V_{RWM}	Reverse stand-off voltage	D+, D– pins to ground				5.5	V
V_{CLAMP}	Clamp voltage	D+, D– pins to ground, $I_{IO} = 1$ A				8	V
I_{IO}	Current from I/O port to supply pins	$V_{IO} = 2.5$ V			0.01	0.1	μA
V_D	Diode forward voltage	D+, D– pins, lower clamp diode,	$V_{IO} = 2.5$ V, $I_D = 8$ mA	0.6	0.8	0.95	V
		D+, D– pins, upper clamp diode, DRY package	$V_{CC} = 0$ V, $I_D = -8$ mA	0.6	0.8	0.95	
R_{DYN}	Dynamic resistance	D+, D– pins,	$I = 1$ A		1		Ω
C_{IO}	I/O capacitance	D+, D– pins, DBZ Package	$V_{IO} = 2.5$ V, $f = 10$ MHz		0.9		pF
		D+, D– pins, DRT Package	$V_{IO} = 2.5$ V, $f = 10$ MHz		0.7		pF
V_{BR}	Break-down voltage	$I_{IO} = 1$ mA		7			V

6.6 Typical Characteristics

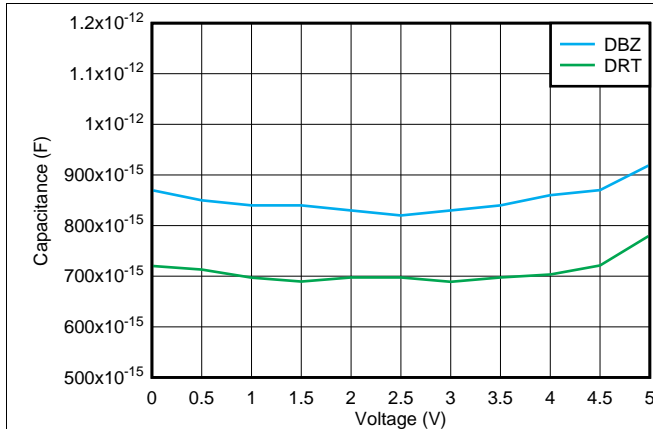

Figure 1. I/O Capacitance vs I/O Voltage ($T_A = 25^\circ\text{C}$)

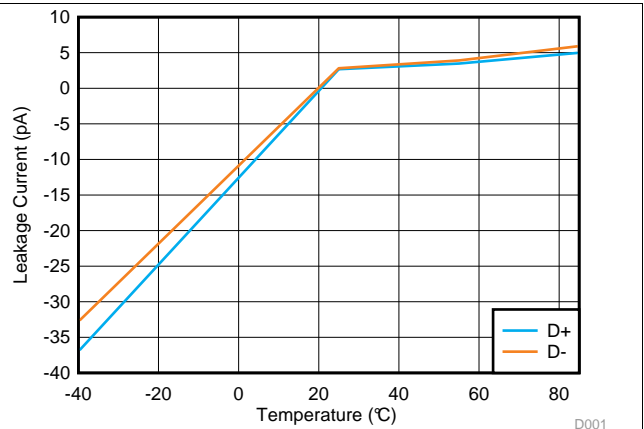

Figure 2. Leakage Current vs Temperature ($V_{IO} = 2.5\text{ V}$)

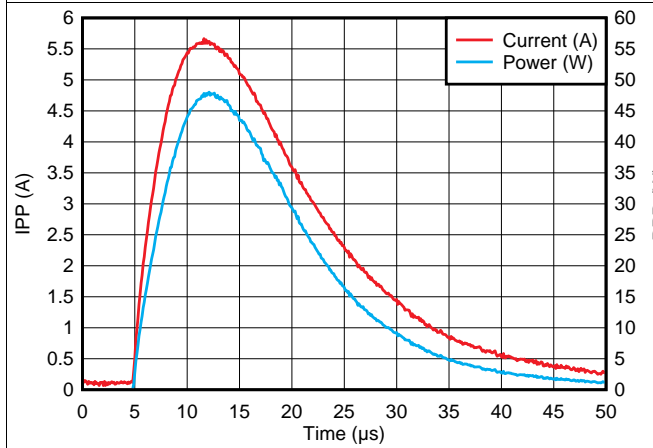

Figure 3. Peak Pulse Waveforms, (Measured at One I/O, With the Other I/O Open)

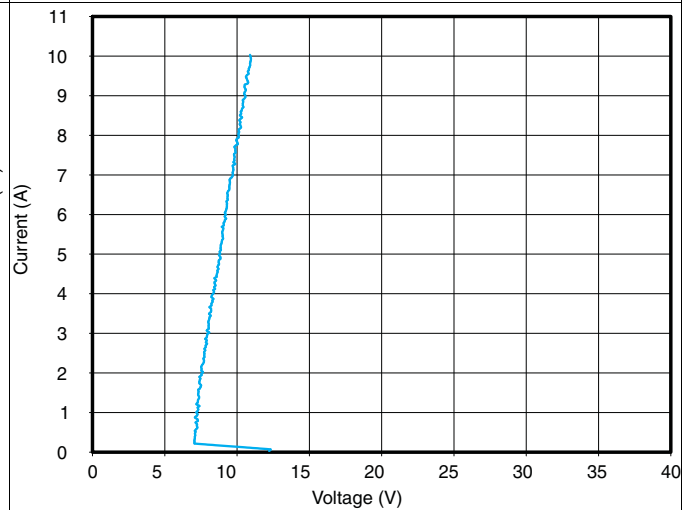

Figure 4. D+, D- Transmission Line Pulser Plot (100-ns Pulse, 10-ns Rise Time)

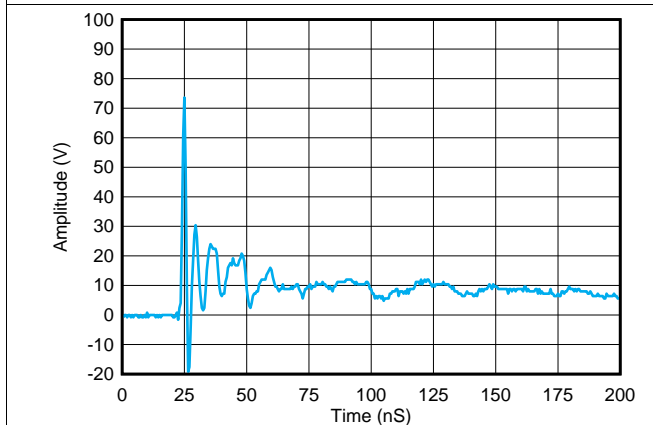

Figure 5. IEC Clamping Waveforms (8-kV Contact)

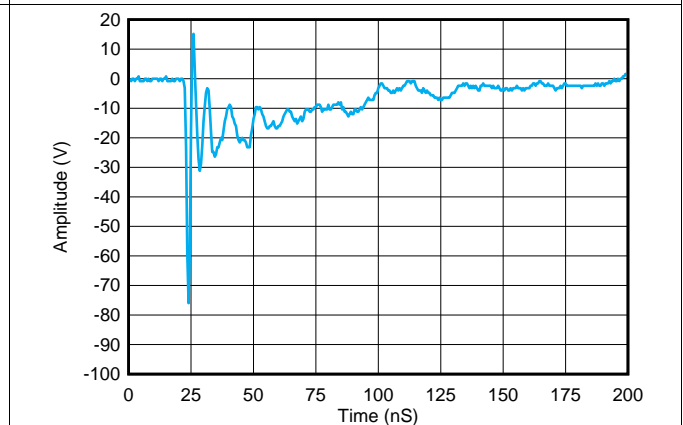

Figure 6. IEC Clamping Waveforms (-8-kV Contact)

7 Detailed Description

7.1 Overview

TPD2E009 is a two-channel ESD TVS that provides ± 8 -kV IEC 61000-4-2 contact and air-gap ESD protection. The 0.7-pF unidirectional diode architecture is suitable for signals that range from 0 V to 5.5 V and can support data rates up to 6 Gbps. The industry-standard packages are convenient for placement in applications with limited space.

7.2 Functional Block Diagram

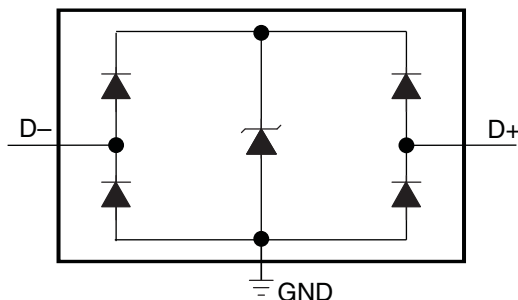

7.3 Feature Description

TPD2E009 is a unidirectional TVS offering IEC 61000-4-2 Level 4 Contact ESD protection. This device protects circuits from ESD strikes up to ± 8 -kV contact and ± 8 -kV air-gap. The device can also handle up to 5-A surge current (IEC 61000-4-5 8/20 μ s). The low capacitance of 0.7 pF supports a data rate up to 6 Gbps. TPD2E009 has a small dynamic resistance of 1 Ω , which makes the clamping voltage low when the device is actively protecting other circuits. For example, the clamping voltage is only 8 V when the device is taking a 1-A transient current. Low leakage allows the diode to conserve power when working below the V_{RWM} .

7.4 Device Functional Modes

The TPD2E009 device is a passive clamp that has low leakage during normal operation when the voltage between an I/O pin and GND is below V_{RWM} . The device activates when the voltage is between an I/O pin and GND goes above V_{BR} . During ESD events, transient voltages as high as ± 8 kV can be clamped between the protected line and ground. When the voltages on the protected lines fall below the trigger voltage, the device reverts back to the low-leakage passive state.

8 Application and Implementation

NOTE

Information in the following applications sections is not part of the TI component specification, and TI does not warrant its accuracy or completeness. TI's customers are responsible for determining suitability of components for their purposes. Customers should validate and test their design implementation to confirm system functionality.

8.1 Application Information

The TPD2E009 device is a diode-array type TVS typically used to provide a path to ground for dissipating ESD events on high-speed signal lines between a human-interface connector and a system. As the current from ESD passes through the TVS, only a small voltage drop is present across the diode. This is the voltage presented to the protected IC. The low R_{DYN} of the triggered TVS holds this voltage, V_{CLAMP} , to a tolerable level to the protected IC.

8.2 Typical Application

The TPD2E009 device is typically used to protect a single high-speed differential pair. Multiple TPD2E009 devices can be used to provide protection for connectors with multiple differential data lanes. This example is applicable to many interface types including:

- HDMI
- USB
- eSATA
- ethernet interfaces

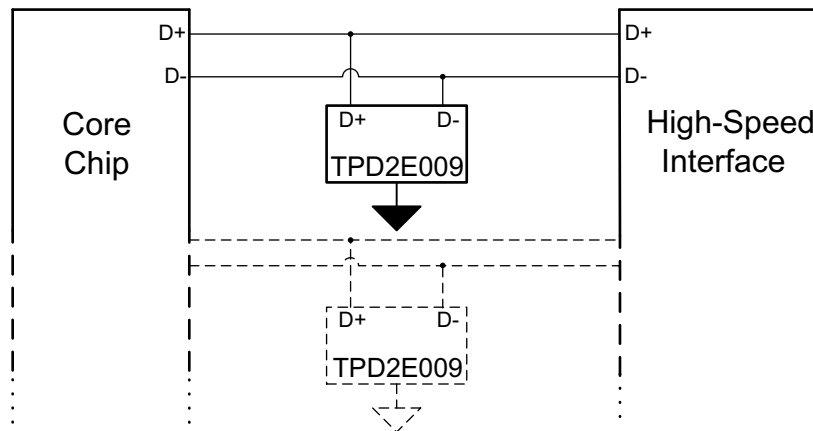

Figure 7. TPD2E009 in a High-Speed Interface

8.2.1 Design Requirements

For this design example, TPD2E009 is used to protect any differential data pair meeting the design requirements shown in the following table.

DESIGN PARAMETER	VALUE
Maximum signal range on D+ and D-	0 V to 5.5 V
Maximum Operating Frequency	3 GHz

8.2.2 Detailed Design Procedure

To begin the design process, some parameters must be decided upon; the designer must know the following:

- The signal voltage range on the protected lines
- The maximum operating frequency

8.2.3 Application Curves

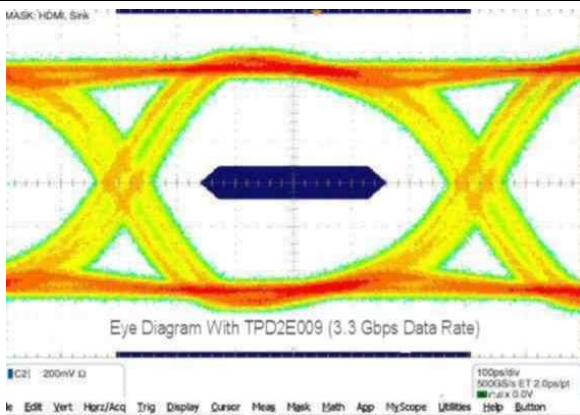

Figure 8. Eye Diagram With TPD2E009 (3.3-Gbps Data Rate) (3-Pin DBZ Package)

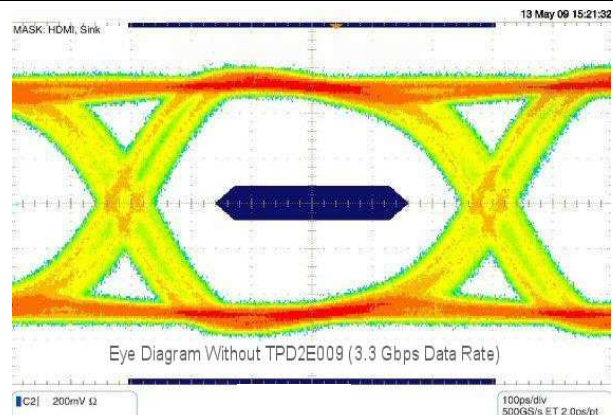

Figure 9. Eye Diagram Without TPD2E009 (3.3-Gbps Data Rate) (3-Pin DBZ Package)

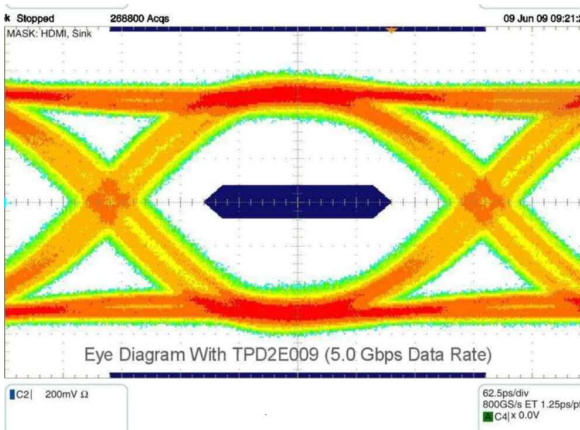

Figure 10. Eye Diagram With TPD2E009 (5-Gbps Data Rate) (3-Pin DBZ Package)

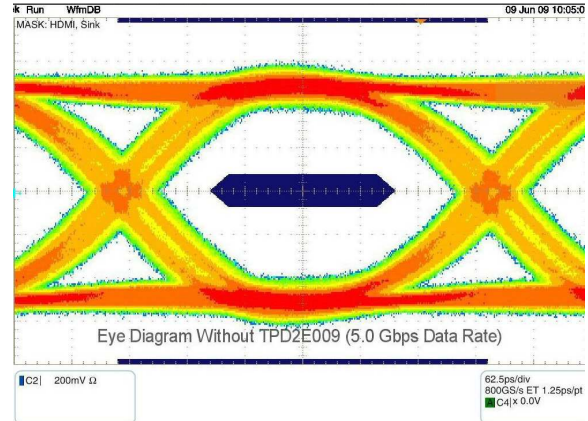

Figure 11. Eye Diagram Without TPD2E009 (5-Gbps Data Rate) (3-Pin DBZ Package)

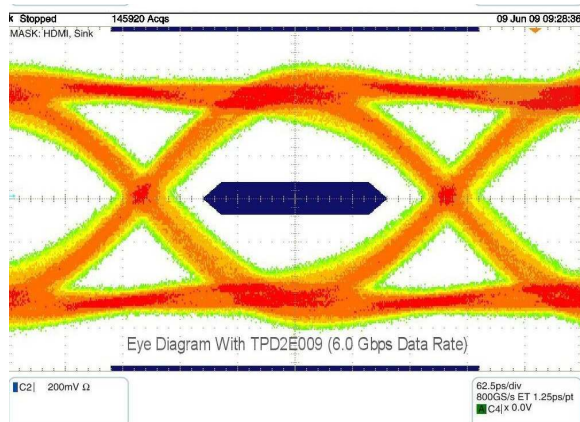

Figure 12. Eye Diagram With TPD2E009 (6-Gbps Data Rate) (3-Pin DBZ Package)

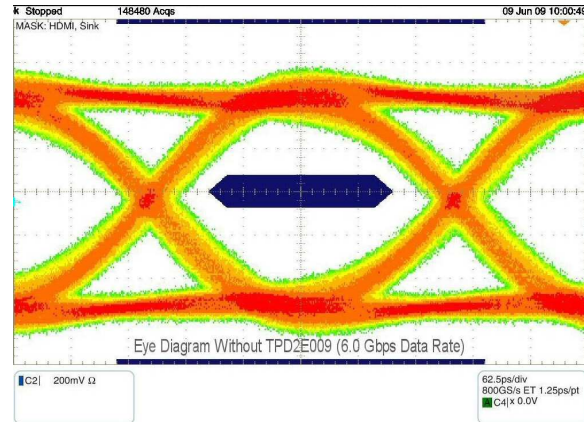

Figure 13. Eye Diagram Without TPD2E009 (6-Gbps Data Rate) (3-Pin DBZ Package)

9 Power Supply Recommendations

The TPD2E009 device is a passive ESD-protection device, and therefore, does not require a power supply. Care must be taken to avoid violating the maximum-voltage specification to ensure that the device functions properly. The D+ and D– lines share a TVS diode that can tolerate up to 5.5 V.

10 Layout

10.1 Layout Guidelines

Layout considerations such as package selection, trace routing, and so forth, must be accounted for while designing the ESD clamp circuit for a high-speed interface. Difficult routing can lead the designer to use vias or stubs in the board traces, which creates significant disruption in the line impedance in the high-speed signal path. Poor package choice can force the designer to route differential traces with unequal lengths and add the skew in the signals. TI recommends coupling the differential traces closely to reduce the EMI interference.

The TPD2E009 can provide system-level ESD protection to the high-speed differential ports (up to 6-Gbps data rate). The flow-through package offers flexibility for board routing with traces up to 15 mils (0.38 mm) wide. [Figure 14](#) and [Figure 15](#) show the board layout scheme for the D+ and D– lines of a single differential pair, which allows the differential signal pairs to couple together right after they touch the ESD ports (pin 1 and pin 2) of the TPD2E009.

10.2 Layout Examples

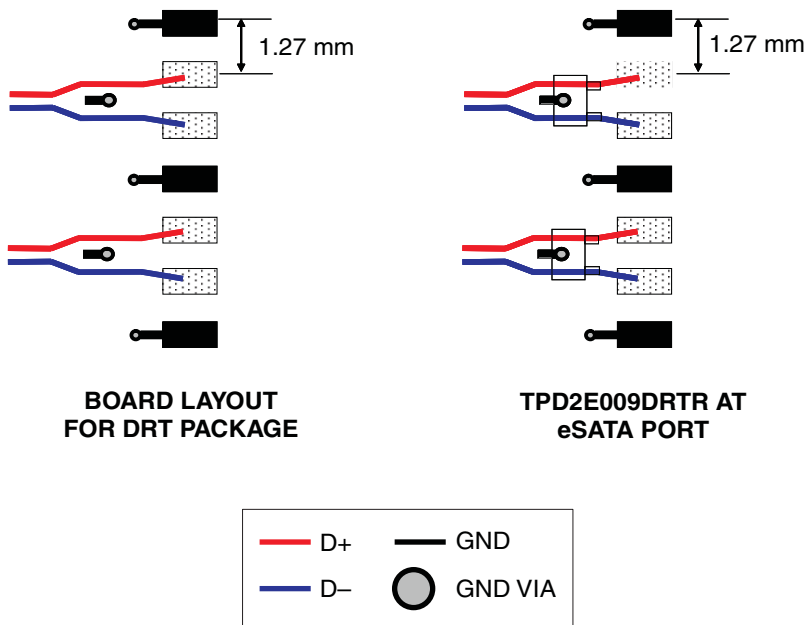

Figure 14. TPD2E009DRTR at eSATA Connector Interface

Layout Examples (continued)

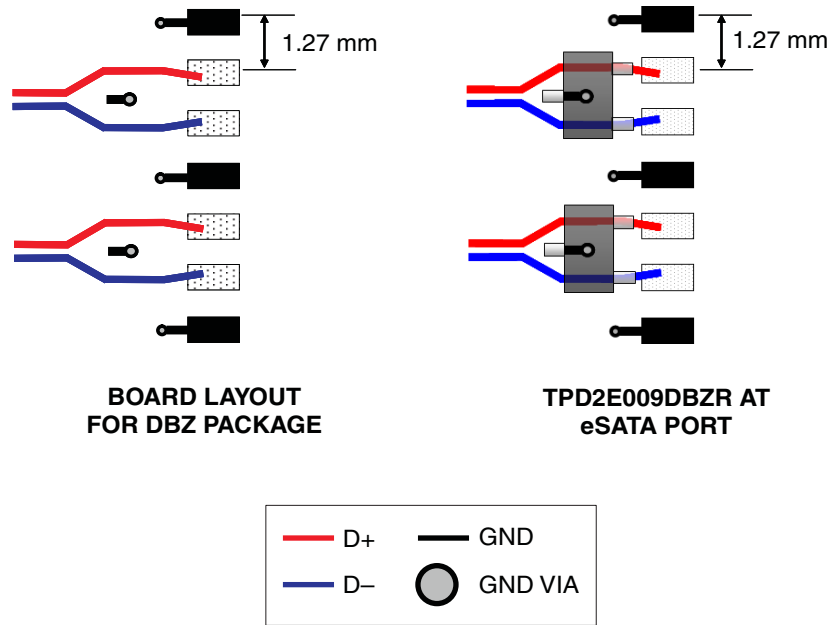

Figure 15. TPD2E009DBZR at eSATA Connector Interface

11 Device and Documentation Support

11.1 Community Resources

The following links connect to TI community resources. Linked contents are provided "AS IS" by the respective contributors. They do not constitute TI specifications and do not necessarily reflect TI's views; see TI's [Terms of Use](#).

TI E2E™ Online Community *TI's Engineer-to-Engineer (E2E) Community*. Created to foster collaboration among engineers. At e2e.ti.com, you can ask questions, share knowledge, explore ideas and help solve problems with fellow engineers.

Design Support *TI's Design Support* Quickly find helpful E2E forums along with design support tools and contact information for technical support.

11.2 Trademarks

E2E is a trademark of Texas Instruments.
All other trademarks are the property of their respective owners.

11.3 Electrostatic Discharge Caution



These devices have limited built-in ESD protection. The leads should be shorted together or the device placed in conductive foam during storage or handling to prevent electrostatic damage to the MOS gates.

11.4 Glossary

[SLYZ022](#) — *TI Glossary*.

This glossary lists and explains terms, acronyms, and definitions.

12 Mechanical, Packaging, and Orderable Information

The following pages include mechanical, packaging, and orderable information. This information is the most current data available for the designated devices. This data is subject to change without notice and revision of this document. For browser-based versions of this data sheet, refer to the left-hand navigation.

PACKAGING INFORMATION

Orderable Device	Status (1)	Package Type	Package Drawing	Pins	Package Qty	Eco Plan (2)	Lead/Ball Finish (6)	MSL Peak Temp (3)	Op Temp (°C)	Device Marking (4/5)	Samples
TPD2E009DBZR	ACTIVE	SOT-23	DBZ	3	3000	Green (RoHS & no Sb/Br)	NIPDAU NIPDAUAG	Level-1-260C-UNLIM	-40 to 85	(NFLO, NFLR)	Samples
TPD2E009DRTR	ACTIVE	SOT-9X3	DRT	3	3000	Green (RoHS & no Sb/Br)	NIPDAU	Level-1-260C-UNLIM	-40 to 85	4T	Samples

(1) The marketing status values are defined as follows:

ACTIVE: Product device recommended for new designs.

LIFEBUY: TI has announced that the device will be discontinued, and a lifetime-buy period is in effect.

NRND: Not recommended for new designs. Device is in production to support existing customers, but TI does not recommend using this part in a new design.

PREVIEW: Device has been announced but is not in production. Samples may or may not be available.

OBSELETE: TI has discontinued the production of the device.

(2) **RoHS:** TI defines "RoHS" to mean semiconductor products that are compliant with the current EU RoHS requirements for all 10 RoHS substances, including the requirement that RoHS substance do not exceed 0.1% by weight in homogeneous materials. Where designed to be soldered at high temperatures, "RoHS" products are suitable for use in specified lead-free processes. TI may reference these types of products as "Pb-Free".

RoHS Exempt: TI defines "RoHS Exempt" to mean products that contain lead but are compliant with EU RoHS pursuant to a specific EU RoHS exemption.

Green: TI defines "Green" to mean the content of Chlorine (Cl) and Bromine (Br) based flame retardants meet JS709B low halogen requirements of <=1000ppm threshold. Antimony trioxide based flame retardants must also meet the <=1000ppm threshold requirement.

(3) MSL, Peak Temp. - The Moisture Sensitivity Level rating according to the JEDEC industry standard classifications, and peak solder temperature.

(4) There may be additional marking, which relates to the logo, the lot trace code information, or the environmental category on the device.

(5) Multiple Device Markings will be inside parentheses. Only one Device Marking contained in parentheses and separated by a "-" will appear on a device. If a line is indented then it is a continuation of the previous line and the two combined represent the entire Device Marking for that device.

(6) Lead/Ball Finish - Orderable Devices may have multiple material finish options. Finish options are separated by a vertical ruled line. Lead/Ball Finish values may wrap to two lines if the finish value exceeds the maximum column width.

Important Information and Disclaimer:The information provided on this page represents TI's knowledge and belief as of the date that it is provided. TI bases its knowledge and belief on information provided by third parties, and makes no representation or warranty as to the accuracy of such information. Efforts are underway to better integrate information from third parties. TI has taken and continues to take reasonable steps to provide representative and accurate information but may not have conducted destructive testing or chemical analysis on incoming materials and chemicals. TI and TI suppliers consider certain information to be proprietary, and thus CAS numbers and other limited information may not be available for release.

In no event shall TI's liability arising out of such information exceed the total purchase price of the TI part(s) at issue in this document sold by TI to Customer on an annual basis.

TAPE AND REEL INFORMATION



QUADRANT ASSIGNMENTS FOR PIN 1 ORIENTATION IN TAPE



*All dimensions are nominal

Device	Package Type	Package Drawing	Pins	SPQ	Reel Diameter (mm)	Reel Width W1 (mm)	A0 (mm)	B0 (mm)	K0 (mm)	P1 (mm)	W (mm)	Pin1 Quadrant
TPD2E009DBZR	SOT-23	DBZ	3	3000	180.0	8.4	3.15	2.77	1.22	4.0	8.0	Q3
TPD2E009DRTR	SOT-9X3	DRT	3	3000	180.0	8.4	1.16	1.16	0.63	4.0	8.0	Q3

TAPE AND REEL BOX DIMENSIONS

*All dimensions are nominal

Device	Package Type	Package Drawing	Pins	SPQ	Length (mm)	Width (mm)	Height (mm)
TPD2E009DBZR	SOT-23	DBZ	3	3000	183.0	183.0	20.0
TPD2E009DRTR	SOT-9X3	DRT	3	3000	202.0	201.0	85.0

GENERIC PACKAGE VIEW

DBZ 3

SOT-23 - 1.12 mm max height

SMALL OUTLINE TRANSISTOR



Images above are just a representation of the package family, actual package may vary.
Refer to the product data sheet for package details.

4203227/C

DBZ0003A



PACKAGE OUTLINE

SOT-23 - 1.12 mm max height

SMALL OUTLINE TRANSISTOR

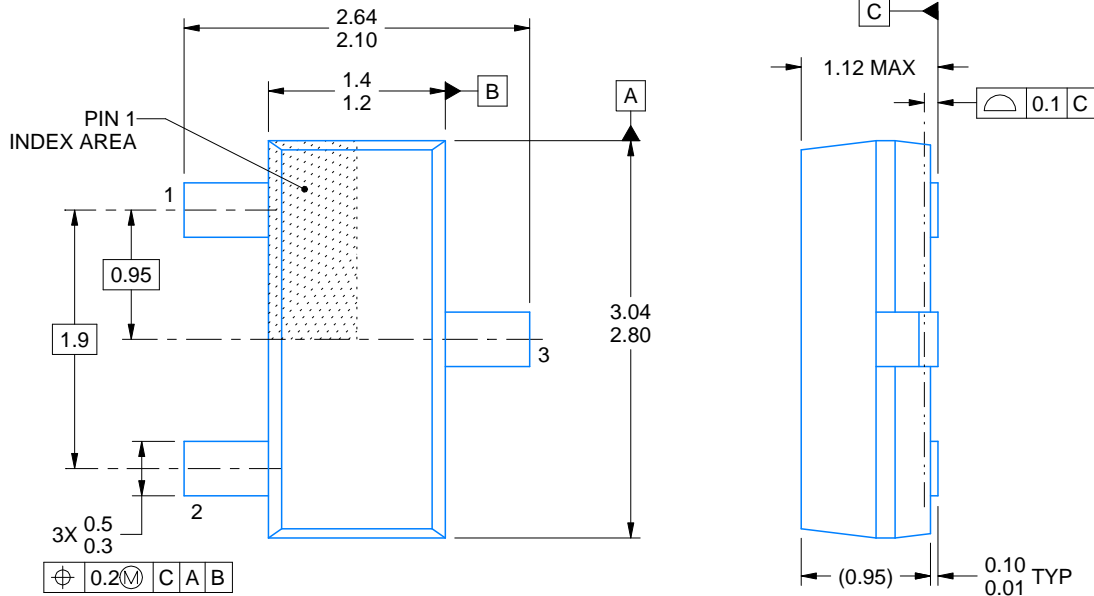

4214838/C 04/2017

NOTES:

1. All linear dimensions are in millimeters. Any dimensions in parenthesis are for reference only. Dimensioning and tolerancing per ASME Y14.5M.
2. This drawing is subject to change without notice.
3. Reference JEDEC registration TO-236, except minimum foot length.

EXAMPLE BOARD LAYOUT

DBZ0003A

SOT-23 - 1.12 mm max height

SMALL OUTLINE TRANSISTOR

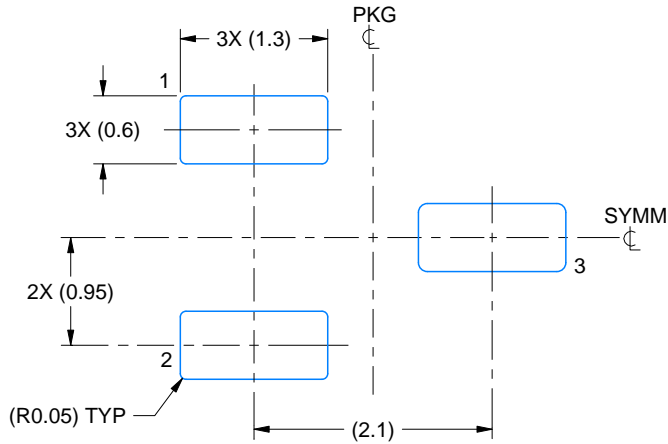

LAND PATTERN EXAMPLE
SCALE:15X

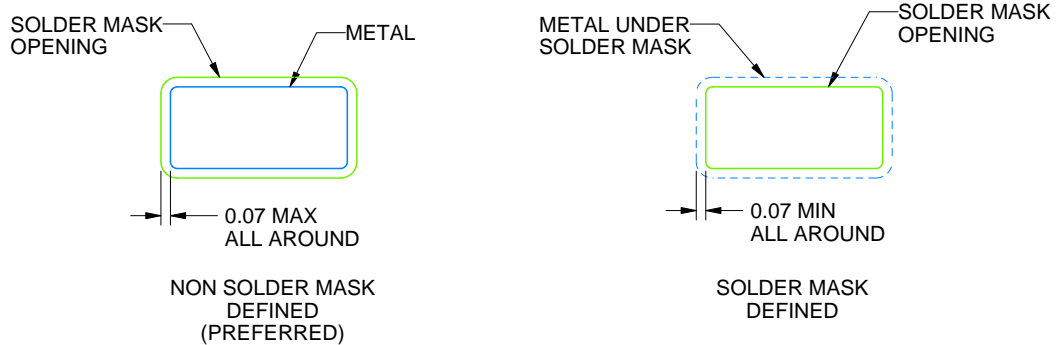

SOLDER MASK DETAILS

4214838/C 04/2017

NOTES: (continued)

4. Publication IPC-7351 may have alternate designs.
5. Solder mask tolerances between and around signal pads can vary based on board fabrication site.

EXAMPLE STENCIL DESIGN

DBZ0003A

SOT-23 - 1.12 mm max height

SMALL OUTLINE TRANSISTOR

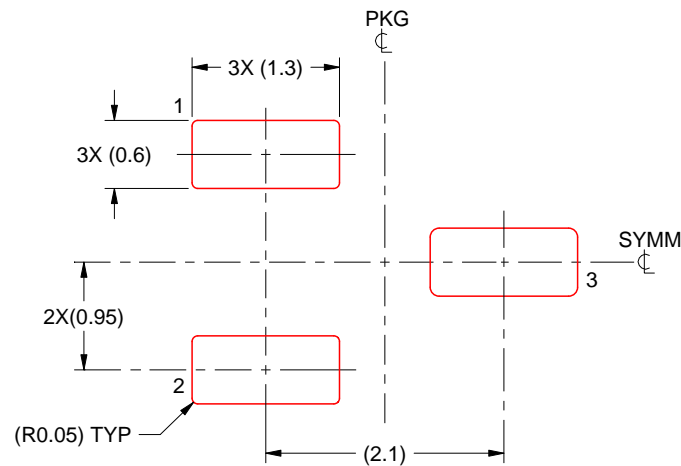

SOLDER PASTE EXAMPLE
BASED ON 0.125 THICK STENCIL
SCALE:15X

4214838/C 04/2017

NOTES: (continued)

6. Laser cutting apertures with trapezoidal walls and rounded corners may offer better paste release. IPC-7525 may have alternate design recommendations.
7. Board assembly site may have different recommendations for stencil design.

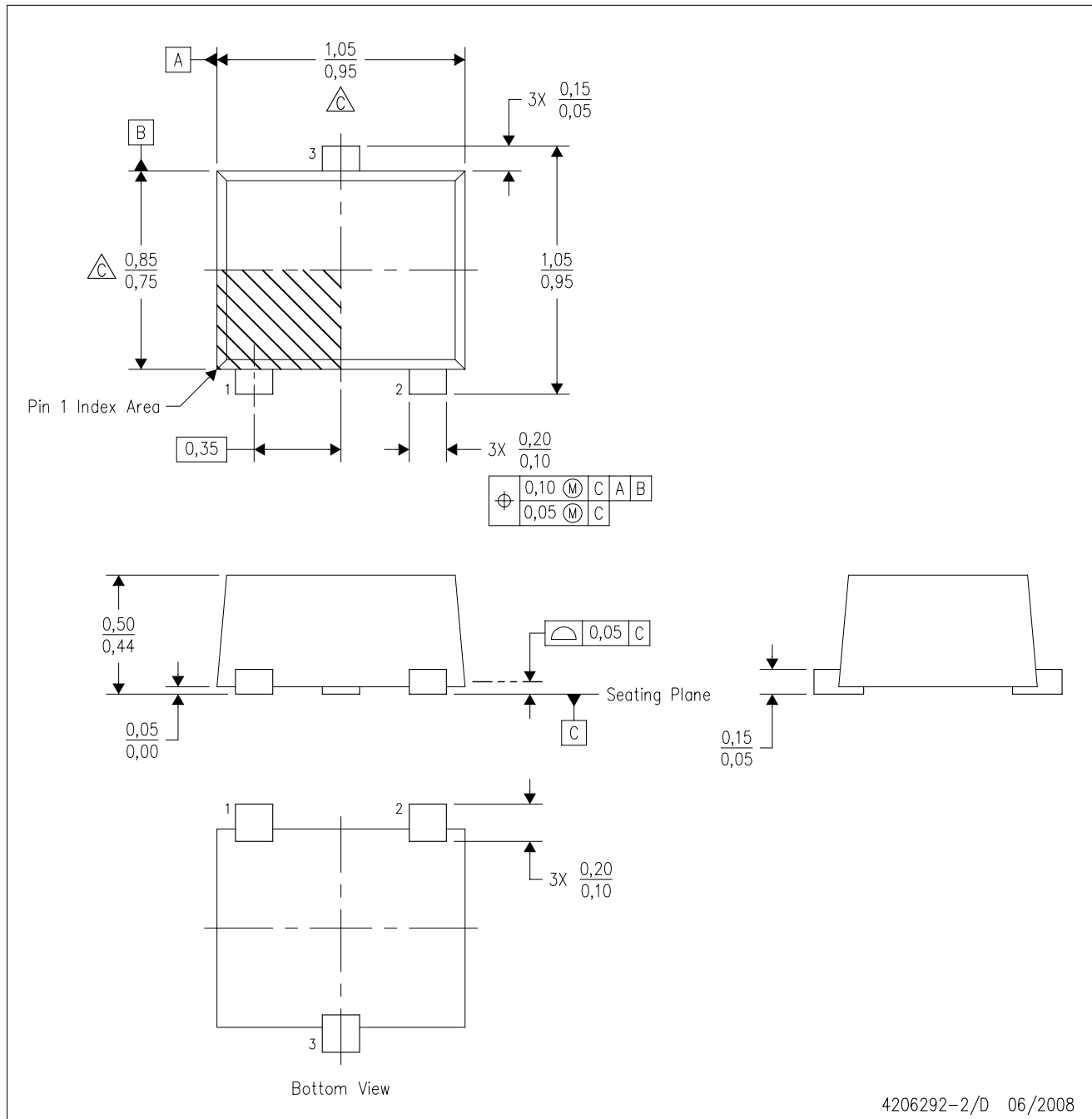

- NOTES:
- A. All linear dimensions are in millimeters. Dimensioning and tolerancing per ASME Y14.5M-1994.
 - B. This drawing is subject to change without notice.
 - C. Body dimensions do not include mold flash, interlead flash, protrusions, or gate burrs. Mold flash, interlead flash, protrusions, or gate burrs shall not exceed 0,10 per end or side.
 - D. JEDEC package registration is pending.

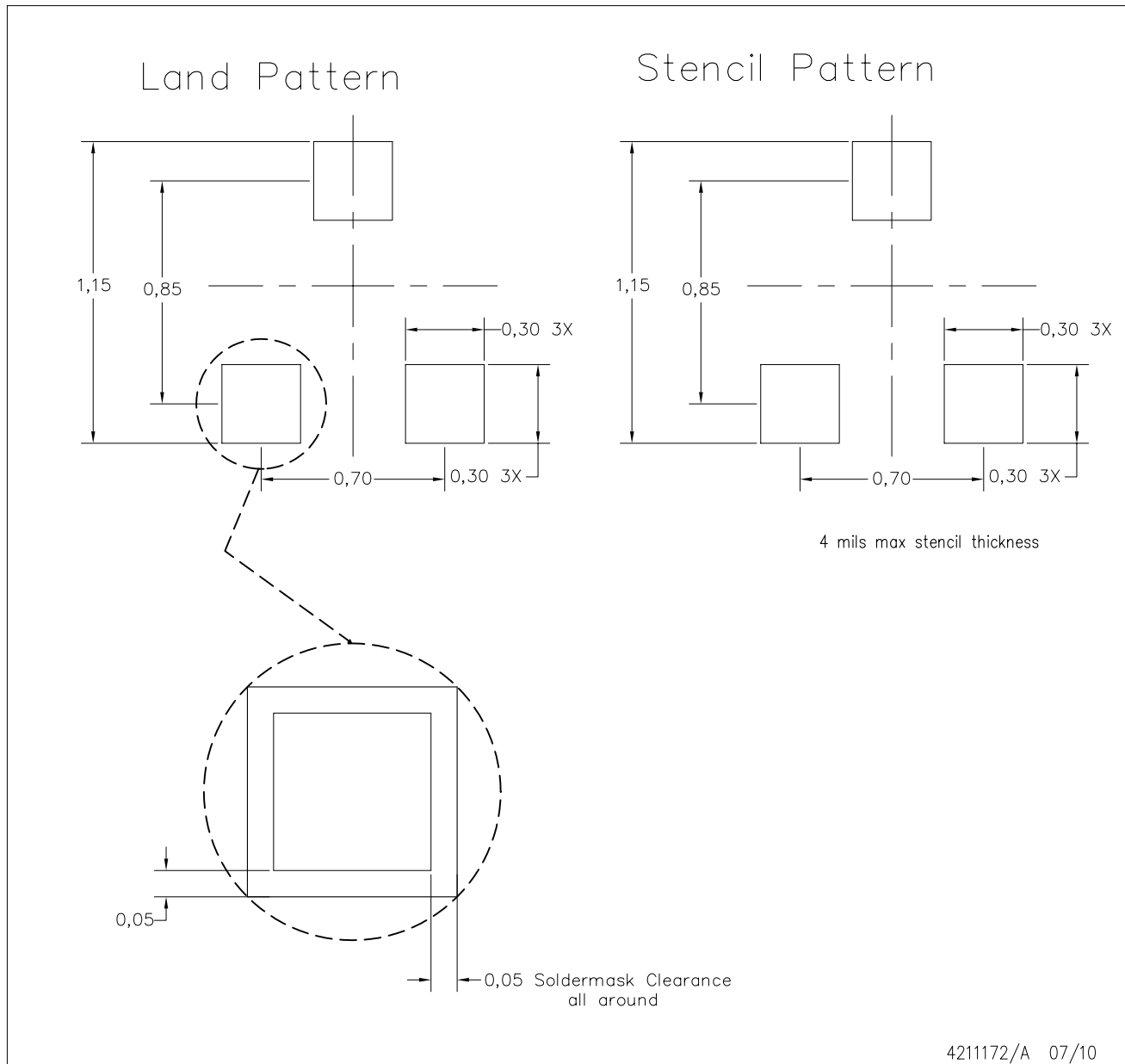

- NOTES:
- A. All linear dimensions are in millimeters.
 - B. This drawing is subject to change without notice.
 - C. Publication IPC-7351 is recommended for alternate designs.
 - D. Customers should contact their board fabrication site for minimum solder mask web tolerances between signal pads.
 - E. Maximum stencil thickness 0,1016 mm (4 mils). All linear dimensions are in millimeters.
 - F. Laser cutting apertures with trapezoidal walls and also rounding corners will offer better paste release. Customers should contact their board assembly site for stencil design recommendations. Refer to IPC 7525 for stencil design considerations.
 - G. Side aperture dimensions over-print land for acceptable area ratio > 0.66. Customer may reduce side aperture dimensions if stencil manufacturing process allows for sufficient release at smaller opening.

IMPORTANT NOTICE AND DISCLAIMER

TI PROVIDES TECHNICAL AND RELIABILITY DATA (INCLUDING DATASHEETS), DESIGN RESOURCES (INCLUDING REFERENCE DESIGNS), APPLICATION OR OTHER DESIGN ADVICE, WEB TOOLS, SAFETY INFORMATION, AND OTHER RESOURCES "AS IS" AND WITH ALL FAULTS, AND DISCLAIMS ALL WARRANTIES, EXPRESS AND IMPLIED, INCLUDING WITHOUT LIMITATION ANY IMPLIED WARRANTIES OF MERCHANTABILITY, FITNESS FOR A PARTICULAR PURPOSE OR NON-INFRINGEMENT OF THIRD PARTY INTELLECTUAL PROPERTY RIGHTS.

These resources are intended for skilled developers designing with TI products. You are solely responsible for (1) selecting the appropriate TI products for your application, (2) designing, validating and testing your application, and (3) ensuring your application meets applicable standards, and any other safety, security, or other requirements. These resources are subject to change without notice. TI grants you permission to use these resources only for development of an application that uses the TI products described in the resource. Other reproduction and display of these resources is prohibited. No license is granted to any other TI intellectual property right or to any third party intellectual property right. TI disclaims responsibility for, and you will fully indemnify TI and its representatives against, any claims, damages, costs, losses, and liabilities arising out of your use of these resources.

TI's products are provided subject to TI's Terms of Sale (www.ti.com/legal/termsofsale.html) or other applicable terms available either on ti.com or provided in conjunction with such TI products. TI's provision of these resources does not expand or otherwise alter TI's applicable warranties or warranty disclaimers for TI products.

Mailing Address: Texas Instruments, Post Office Box 655303, Dallas, Texas 75265
Copyright © 2020, Texas Instruments Incorporated