

FEATURES

- ±4000 V human body model (HBM) ESD**
- High common-mode voltage range**
 - 2 V to +65 V operating
 - 3 V to +68 V survival
- Buffered output voltage**
- Wide operating temperature range**
 - 8-Lead SOIC: –40°C to +125°C
- Excellent ac and dc performance**
 - 6 $\mu\text{V}/^\circ\text{C}$ typical offset drift
 - 8 ppm/ $^\circ\text{C}$ typical gain drift
 - 120 dB typical CMRR at dc
- Qualified for automotive applications**

APPLICATIONS

- High-side current sensing**
 - Motor controls
 - Transmission controls
 - Engine management
 - Suspension controls
 - Vehicle dynamic controls
 - DC to dc converters

GENERAL DESCRIPTION

The **AD8215** is a high voltage, precision current shunt monitor. It features a set gain of 20 V/V, with a maximum $\pm 0.3\%$ gain error over the entire temperature range. The buffered output voltage directly interfaces with any typical converter. Excellent common-mode rejection from –2 V to +65 V is independent of the 5 V supply. The **AD8215** performs unidirectional current measurements across a shunt resistor in a variety of industrial and automotive applications, such as motor controls, solenoid controls, or battery management.

FUNCTIONAL BLOCK DIAGRAM



Figure 1.

07203-001

Special circuitry is devoted to output linearity being maintained throughout the input differential voltage range of 0 mV to 250 mV, regardless of the common-mode voltage present. The **AD8215** has an operating temperature range of –40°C to +125°C and is offered in a small 8-lead SOIC package.

TABLE OF CONTENTS

Features	1	Application Notes	11
Applications	1	Output Linearity	11
Functional Block Diagram	1	Applications Information	12
General Description	1	High-Side Current Sensing with a Low-Side Switch	12
Revision History	2	High-Side Current Sensing	12
Specifications	3	Low-Side Current Sensing	12
Absolute Maximum Ratings	4	Outline Dimensions	13
ESD Caution	4	Ordering Guide	13
Pin Configuration and Function Descriptions	5	Automotive Products	13
Typical Performance Characteristics	6		
Theory of Operation	10		

REVISION HISTORY

12/2016—Rev. A to Rev. B

Changes to Features Section and Applications Section	1
Changes to Figure 30	12

10/2011—Rev. 0 to Rev. A

Change to Applications Section	1
Updated Outline Dimensions	13
Changes to Ordering Guide	13
Added Automotive Products Section	13

1/2008—Revision 0: Initial Version

SPECIFICATIONS

Operating temperature range (T_{OPR}) = -40°C to $+125^{\circ}\text{C}$, ambient temperature (T_A) = 25°C , $V_S = 5\text{ V}$, $R_L = 25\text{ k}\Omega$ (R_L is the output load resistor), unless otherwise noted.

Table 1.

Parameter	Min	Typ	Max	Unit	Test Conditions/Comments
GAIN					
Initial		20		V/V	
Accuracy			± 0.15	%	Output voltage (V_O) $\geq 0.1\text{ V dc}$, T_A
Accuracy Over Temperature			± 0.3	%	T_{OPR}
Drift	0	-8	-15	ppm/ $^{\circ}\text{C}$	T_{OPR}
VOLTAGE OFFSET					
Offset Voltage, Referred to Input (RTI)			± 1	mV	T_A
Over Temperature (RTI)			± 2.5	mV	T_{OPR}
Drift	-15	+6	+18	$\mu\text{V}/^{\circ}\text{C}$	T_{OPR}
INPUT					
Input Impedance					
Differential		5		k Ω	
Common Mode		5		M Ω	Common-mode voltage $> 5\text{ V}$
		3.5		k Ω	Common-mode voltage $< 5\text{ V}$
Common-Mode Input Voltage Range	-2		+65	V	Common-mode continuous
Differential Input Voltage Range		250		mV	Differential input voltage
Common-Mode Rejection Ratio	100	120		dB	T_{OPR} , $f = \text{dc to } 50\text{ kHz}$, $V_{CM} > 5\text{ V}$
	80	90		dB	T_{OPR} , $f = \text{dc to } 40\text{ kHz}$, $V_{CM} < 5\text{ V}$
OUTPUT					
Output Voltage Range Low		0.03		V	T_A
	0.10			V	T_{OPR}
Output Voltage Range High		4.95		V	T_A
			4.90	V	T_{OPR}
Output Impedance		2		Ω	
DYNAMIC RESPONSE					
Small Signal -3 dB Bandwidth		450		kHz	T_{OPR}
Slew Rate		4.5		V/ μs	T_A
NOISE					
0.1 Hz to 10 Hz, RTI		7		$\mu\text{V p-p}$	
Spectral Density, 1 kHz, RTI		70		nV/ $\sqrt{\text{Hz}}$	
POWER SUPPLY					
Operating Range	4.5		5.5	V	
Quiescent Current Over Temperature		1.3	2.2	mA	$V_{CM} > 5\text{ V}^1$, T_{OPR}
Power Supply Rejection Ratio	75			dB	T_{OPR}
TEMPERATURE RANGE					
For Specified Performance	-40		+125	$^{\circ}\text{C}$	

¹ When the common-mode input voltage is less than 5 V, the supply current increases, which can be calculated by $I_S = -0.275 (V_{CM}) + 2.5$.

ABSOLUTE MAXIMUM RATINGS

Table 2.

Parameter	Rating
Supply Voltage	12.5 V
Continuous Input Voltage (Survival)	-3 V to +68 V
Continuous Differential Input Voltage	0.5 V
Reverse Supply Voltage	-0.3 V
ESD Rating	
HBM	±4000 V
Charged Device Model (CDM)	±1000 V
Operating Temperature Range	-40°C to +125°C
Storage Temperature Range	-65°C to +150°C
Output Short-Circuit Duration	Indefinite

Stresses at or above those listed under Absolute Maximum Ratings may cause permanent damage to the product. This is a stress rating only; functional operation of the product at these or any other conditions above those indicated in the operational section of this specification is not implied. Operation beyond the maximum operating conditions for extended periods may affect product reliability.

ESD CAUTION



ESD (electrostatic discharge) sensitive device. Charged devices and circuit boards can discharge without detection. Although this product features patented or proprietary protection circuitry, damage may occur on devices subjected to high energy ESD. Therefore, proper ESD precautions should be taken to avoid performance degradation or loss of functionality.

PIN CONFIGURATION AND FUNCTION DESCRIPTIONS

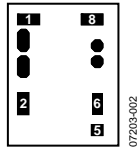

Figure 2. Metallization Diagram



Figure 3. Pin Configuration

Table 3. Pin Function Descriptions

Pin No.	Mnemonic	X	Y	Description
1	-IN	-228	+519	Inverting Input
2	GND	-273	-251	Ground
3, 4, 7	NC	Not applicable	Not applicable	No Connect
5	OUT	+265	-466	Buffered Output
6	V+	+273	-266	Supply
8	+IN	+229	+519	Noninverting Input

TYPICAL PERFORMANCE CHARACTERISTICS

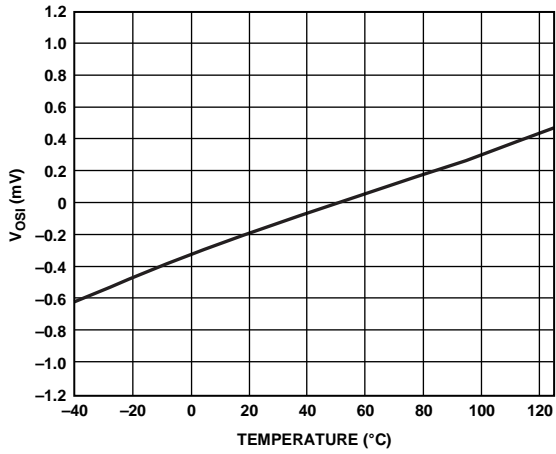

Figure 4. Typical Offset Drift (V_{OS}) vs. Temperature

07203-017

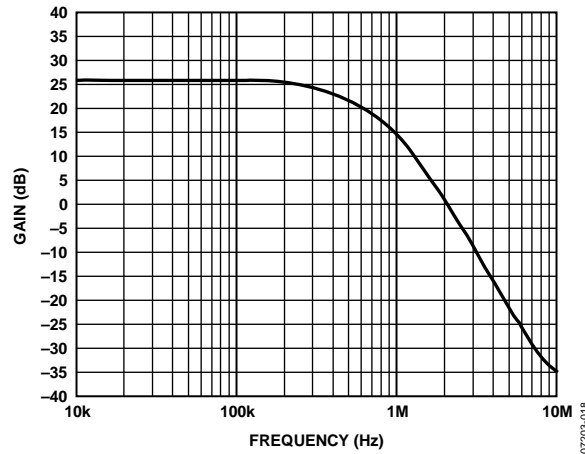

Figure 7. Typical Small Signal Bandwidth ($V_{OUT} = 200 \text{ mV p-p}$)

07203-018

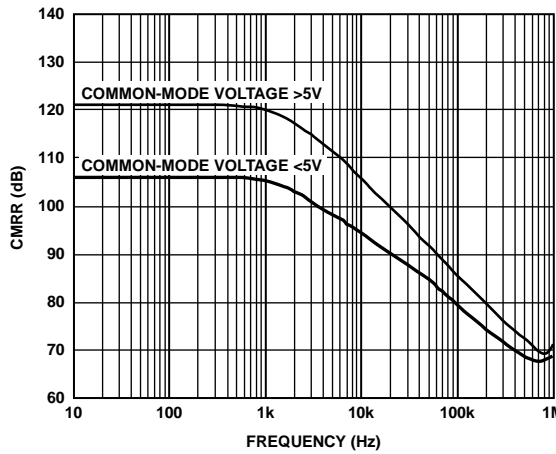

Figure 5. Typical CMRR vs. Frequency

07203-024

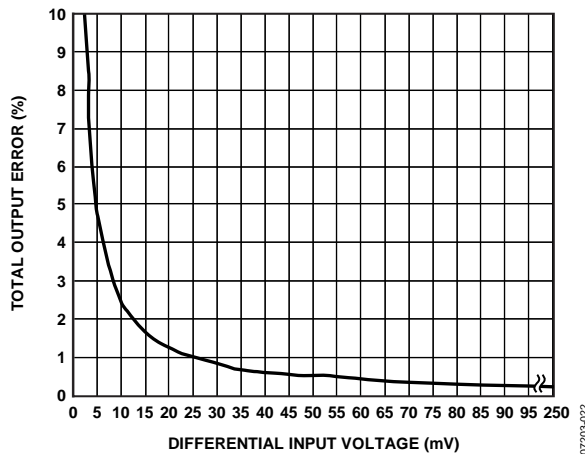

Figure 8. Total Output Error vs. Differential Input Voltage

07203-022

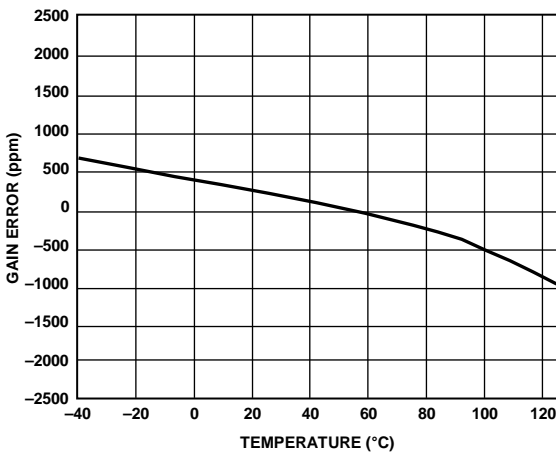

Figure 6. Typical Gain Error vs. Temperature

07203-016

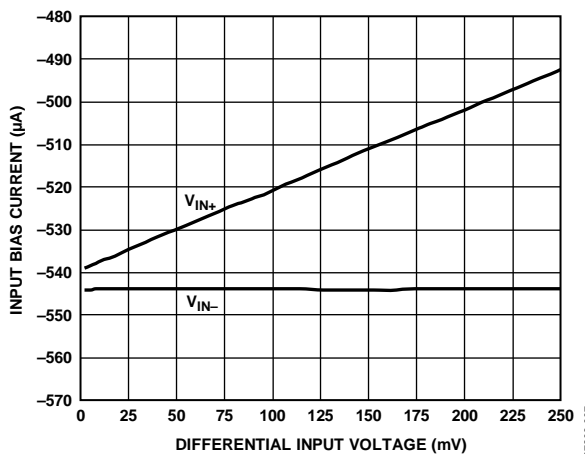

Figure 9. Input Bias Current vs. Differential Input Voltage, $V_{CM} = 0 \text{ V}$

07203-007



Figure 10. Input Bias Current vs. Differential Input Voltage, $V_{CM} = 5V$

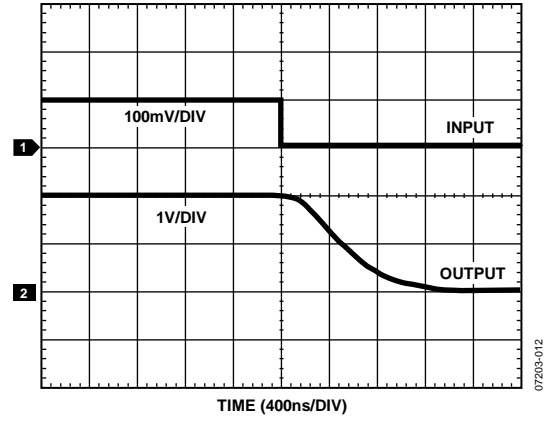

Figure 13. Fall Time

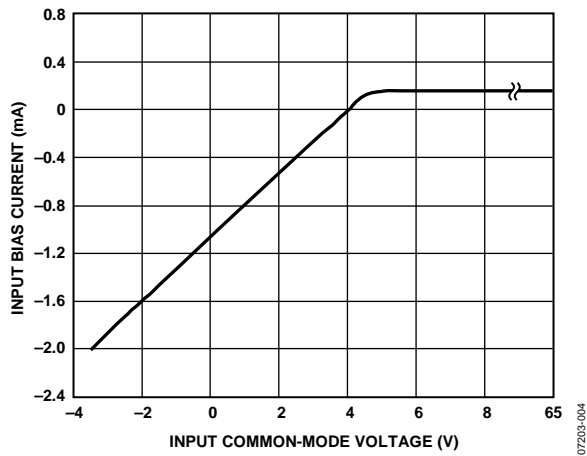

Figure 11. Input Bias Current vs. Input Common-Mode Voltage

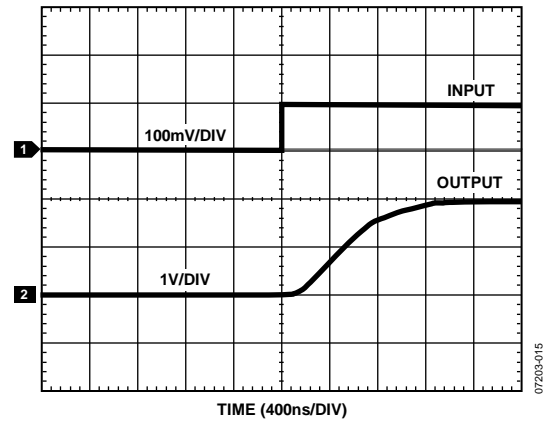

Figure 14. Rise Time

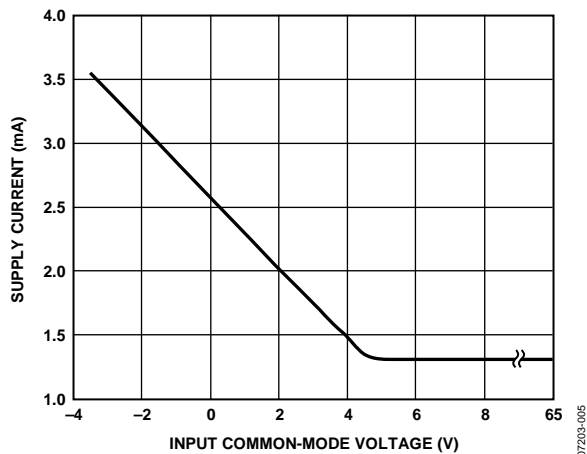

Figure 12. Supply Current vs. Input Common-Mode Voltage

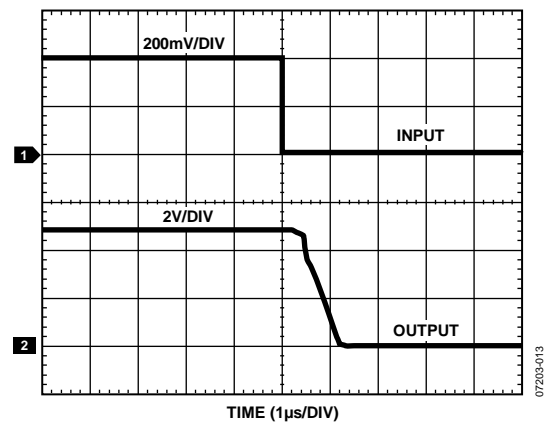

Figure 15. Differential Overload Recovery (Falling)

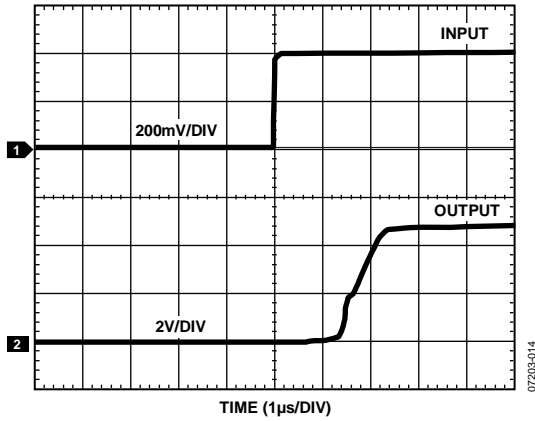

Figure 16. Differential Overload Recovery (Rising)

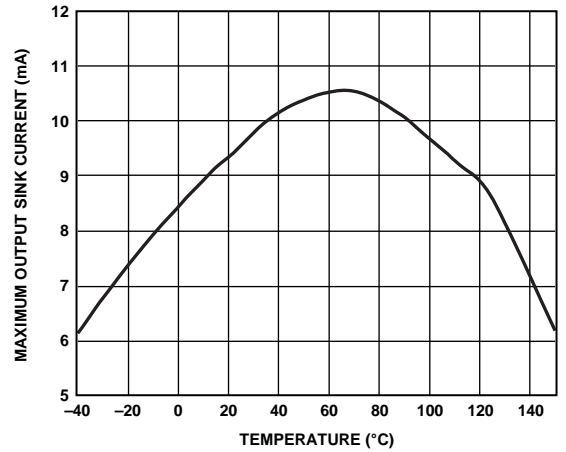

Figure 19. Maximum Output Sink Current vs. Temperature

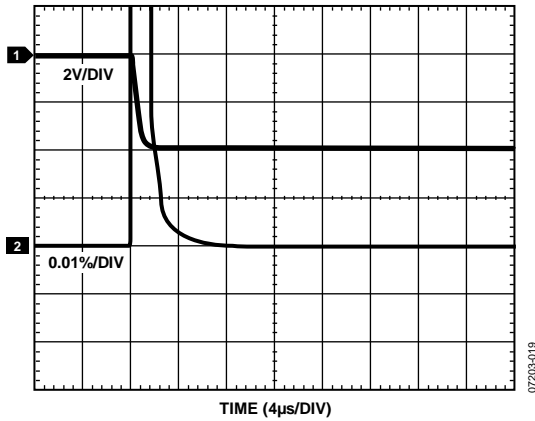

Figure 17. Settling Time (Falling)

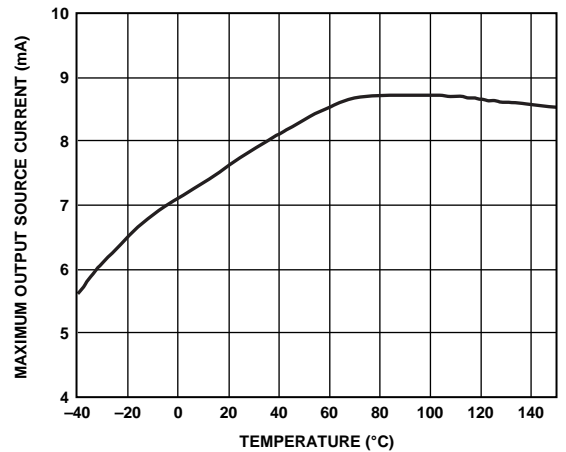

Figure 20. Maximum Output Source Current vs. Temperature

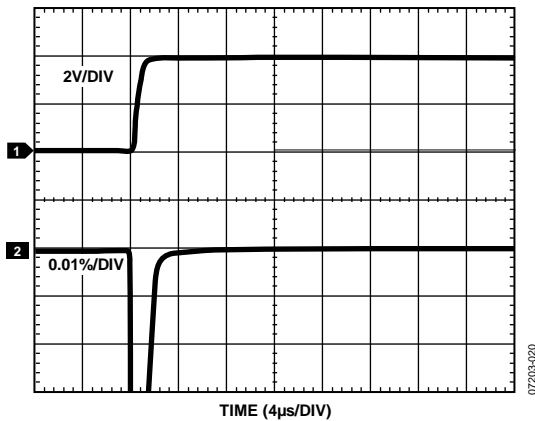

Figure 18. Settling Time (Rising)

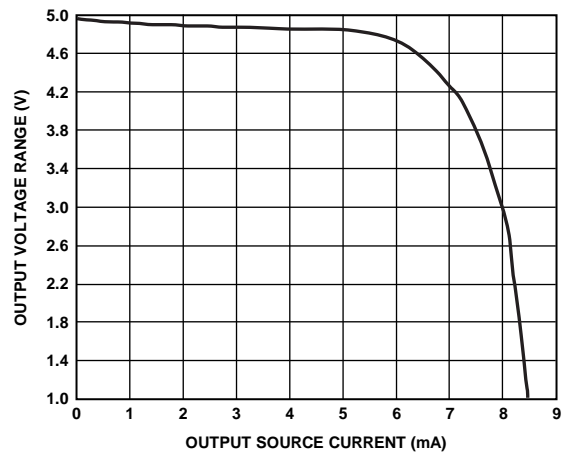

Figure 21. Output Voltage Range vs. Output Source Current

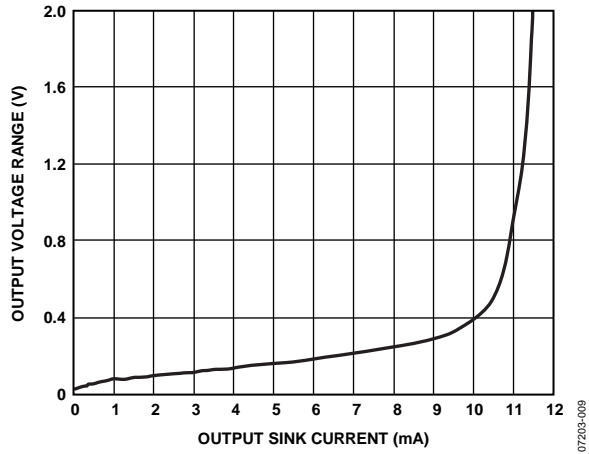

Figure 22. Output Voltage Range from GND vs. Output Sink Current

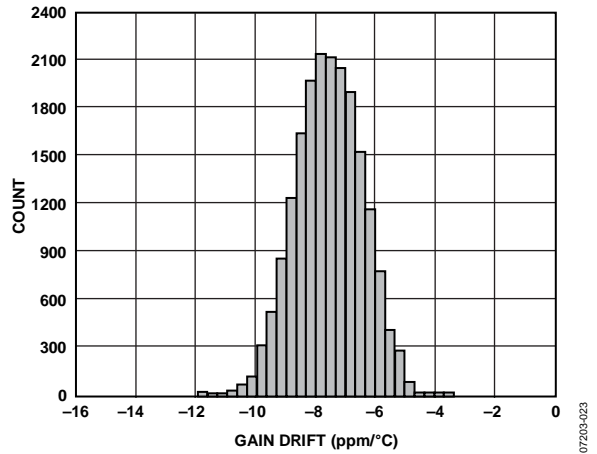

Figure 24. Gain Drift Distribution

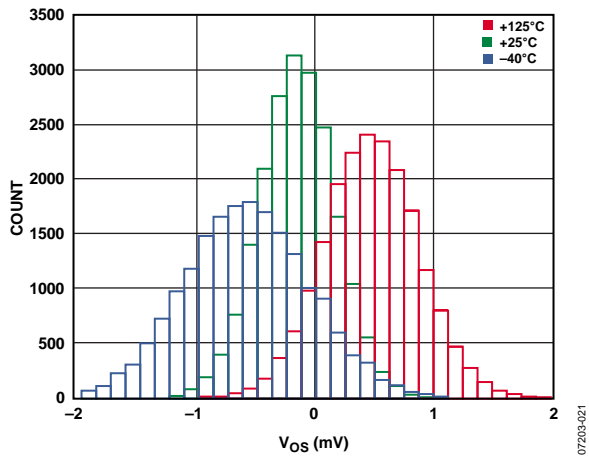

Figure 23. Offset Distribution (V_{OS})

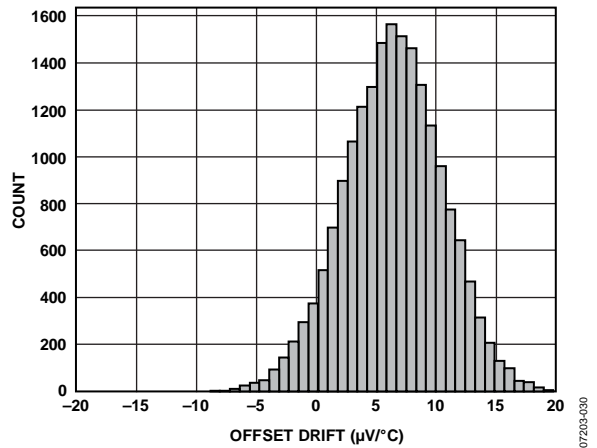

Figure 25. Offset Drift

THEORY OF OPERATION

In typical applications, the AD8215 amplifies a small differential input voltage generated by the load current flowing through a shunt resistor. The AD8215 rejects high common-mode voltages (up to 65 V) and provides a ground-referenced, buffered output that interfaces with an analog-to-digital converter (ADC). Figure 26 shows a simplified schematic of the AD8215.



Figure 26. Simplified Schematic

07203-025

A load current flowing through the external shunt resistor produces a voltage at the input terminals of the AD8215. R and R1 connect the input terminals to A1. The inverting terminal, which has very high input impedance, is held to

$$(V_{CM}) - (I_{SHUNT} \times R_{SHUNT})$$

because negligible current flows through R. A1 forces the noninverting input to the same potential. Therefore, the current that flows through R1 is equal to

$$I_{IN} = (I_{SHUNT} \times R_{SHUNT})/R1$$

This current (I_{IN}) is converted back to a voltage via R_{OUT} . The output buffer amplifier has a gain of 20 V/V and offers excellent accuracy as the internal gain setting resistors are precision trimmed to within 0.01% matching. The resulting output voltage is equal to

$$OUT = (I_{SHUNT} \times R_{SHUNT}) \times 20$$

APPLICATION NOTES

OUTPUT LINEARITY

In all current sensing applications, and especially in automotive and industrial environments where the common-mode voltage can vary significantly, it is important that the current sensor maintain the specified output linearity, regardless of the input differential or common-mode voltage. The AD8215 contains specific circuitry on the input stage, which ensures that even when the differential input voltage is very small and the common-mode voltage is also low (below the 5 V supply), the input-to-output linearity is maintained. Figure 27 shows the differential input voltage vs. the corresponding output voltage at different common modes.



Figure 27. Gain Linearity due to Differential and Common-Mode Voltage

Regardless of the common mode, the AD8215 provides a correct output voltage when the differential input is at least 2 mV, which is due to the voltage range of the output amplifier that can go as low as 33 mV typical. The specified minimum output amplifier voltage is 100 mV to provide sufficient guard-bands. The ability of the AD8215 to work with very small differential inputs, regardless of the common-mode voltage, allows more dynamic range, accuracy, and flexibility in any current sensing application.

APPLICATIONS INFORMATION

HIGH-SIDE CURRENT SENSING WITH A LOW-SIDE SWITCH

In such load control configurations, the PWM-controlled switch is ground referenced. An inductive load (solenoid) is tied to a power supply. A resistive shunt is placed between the switch and the load (see Figure 28). An advantage of placing the shunt on the high side is that the entire current, including the recirculation current, can be measured because the shunt remains in the loop when the switch is off. In addition, diagnostics can be enhanced because shorts to ground can be detected with the shunt on the high side. In this circuit configuration, when the switch is closed, the common-mode voltage moves down to near the negative rail. When the switch is opened, the voltage reversal across the inductive load causes the common-mode voltage to be held one diode drop above the battery by the clamp diode.



Figure 28. Low-Side Switch

HIGH-SIDE CURRENT SENSING

In this configuration, the shunt resistor is referenced to the battery. High voltage is present at the inputs of the current sense amplifier. In this mode, the recirculation current is again measured and shorts to ground can be detected. When the shunt is battery referenced, the AD8215 produces a linear ground-referenced analog output. An AD8214 can also provide an overcurrent detection signal in as little as 100 ns (see Figure 29). This feature is useful in high current systems where fast shutdown in over-current conditions is essential.



Figure 29. Battery-Referenced Shunt Resistor

LOW-SIDE CURRENT SENSING

In systems where low-side current sensing is preferred, the AD8215 provides an integrated solution with great accuracy. Ground noise is rejected, CMRR is typically higher than 90 dB, and output linearity is not compromised, regardless of the input differential voltage.

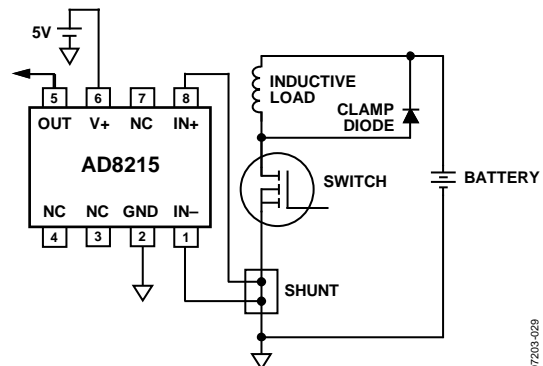

Figure 30. Ground-Referenced Shunt Resistor

OUTLINE DIMENSIONS



COMPLIANT TO JEDEC STANDARDS MS-012-AA
 CONTROLLING DIMENSIONS ARE IN MILLIMETERS; INCH DIMENSIONS
 (IN PARENTHESES) ARE ROUNDED-OFF MILLIMETER EQUIVALENTS FOR
 REFERENCE ONLY AND ARE NOT APPROPRIATE FOR USE IN DESIGN.

012407-A

Figure 31. 8-Lead Standard Small Outline Package [SOIC_N]
 Narrow Body
 (R-8)
 Dimensions shown in millimeters and (inches)

ORDERING GUIDE

Model ^{1,2}	Temperature Range	Package Description	Package Option
AD8215YRZ	-40°C to +125°C	8-Lead Standard Small Outline Package [SOIC_N]	R-8
AD8215YRZ-RL	-40°C to +125°C	8-Lead Standard Small Outline Package [SOIC_N], 13" Tape and Reel	R-8
AD8215YRZ-R7	-40°C to +125°C	8-Lead Standard Small Outline Package [SOIC_N], 7" Tape and Reel	R-8
AD8215WYRZ	-40°C to +125°C	8-Lead Standard Small Outline Package [SOIC_N]	R-8
AD8215WYRZ-R7	-40°C to +125°C	8-Lead Standard Small Outline Package [SOIC_N], 7" Tape and Reel	R-8
AD8215WYRZ-RL	-40°C to +125°C	8-Lead Standard Small Outline Package [SOIC_N], 13" Tape and Reel	R-8

¹ Z = RoHS Compliant Part.
² W = Qualified for Automotive Applications.

AUTOMOTIVE PRODUCTS

The [AD8215WYRZ](#) models are available with controlled manufacturing to support the quality and reliability requirements of automotive applications. Note that these automotive models may have specifications that differ from the commercial models; therefore designers should review the Specifications section of this data sheet carefully. Only the automotive grade products shown are available for use in automotive applications. Contact your local Analog Devices account representative for specific product ordering information and to obtain the specific Automotive Reliability reports for these models.