



Gecko[®] MCUs

Energy-friendly microcontrollers for the IoT

PRODUCT SELECTOR GUIDE



32

Gecko MCUs

Complete portfolio of energy-friendly 32-bit microcontrollers

Everything you need to create a more connected world.

Based on ARM® Cortex® -M0+, Cortex-M3 and Cortex-M4 cores, Gecko MCUs also include the most energy-friendly peripherals and energy modes to enable design of highly functional low power systems.

“Our portfolio was designed to help you innovate. Gecko MCUs and Wireless Geckos are built on the same architecture so you can leverage a single set of software, tools, and experience and focus on what really matters.”

Alessandro Piovaccari | Senior Vice President and Chief Technology Officer



Sense

Intelligent sensor solutions with superb reliability, compact size, high levels of integration and unmatched ease of use for a variety of applications.

Temperature | Humidity | Optical | Touch | Proximity



Compute

The computing power you need with power efficiency you didn't know was possible.

Autonomous | Low Power | Signal Processing | Mixed Signal | Easy to Use



Communicate

Connectivity is at the heart of the IoT, and our wireless portfolio is how you achieve it.

Zigbee | Thread | WiFi | Bluetooth® Smart | Proprietary



Simplify

Get up and running quickly with precompiled demos, application notes and examples. Use advanced tools including energy profiling and network analysis to optimize your MCU and wireless systems.

Simplicity Studio® | Energy Profiler™ | Network Analyzer | Rich Software Ecosystem

Low Power. No Compromise.



The Gecko is excellent at conserving energy. Even in a full resting state it can still maintain awareness of its environment.



Built using Gecko Technology Gecko MCUs can perform a number of tasks while in deep sleep optimizing battery life for your application

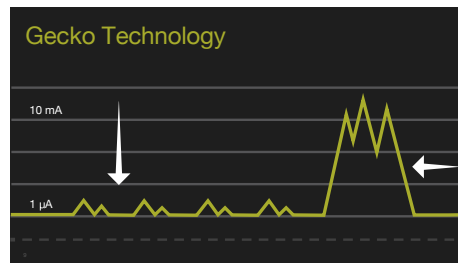
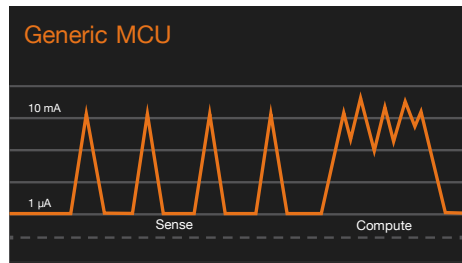

Usable Sleep Modes

- Fast 2 µs wakeup
- Autonomous communication and sense
- Optimize sleep with the Energy Profiler
- More sleep gives significant savings

Highly Functional Low Power

- Down to 80 µA/MHz code execution
- DSP and floating point up to 72 MHz
- Highly flexible DMA offloads CPU
- Cryptography for secure communication

Interfacing with the World

- Broad set of communication peripherals
- Integrated ADCs, DACs, OPAMPs
- Ultra-low energy Sensor Interfaces
- Easy path to radio integration

Human Interaction

- TFT display engine, up to 320 x 240 pixels
- Low energy segment LCD driver
- Low energy capacitive touch solution

Small Form Factor

- High integration – few external components
- WLCSP packages for minimum footprint
- Gecko Technology minimizes battery size

Highly Scalable

- Broad software and pin compatibility
- Same architecture for MCUs and RF SoCs
- Small Cortex M0+ to large Cortex M3 and M4

Enabling Software

- Commercial grade Micrium OS
- Solid RF and communication stacks
- Security through accelerated mbedTLS

Development Flow

- Centered around the developer
- Intuitive workflow
- Support for your favorite tool

Technical Overview

Gecko MCUs were designed for innovation. The diagram below shows an overview of the wide range of functionality available in these MCUs. The color coding represents the lowest energy mode the functions are available down to. The ability for peripherals to operate during deep sleep and below allows significant energy savings in low power applications.

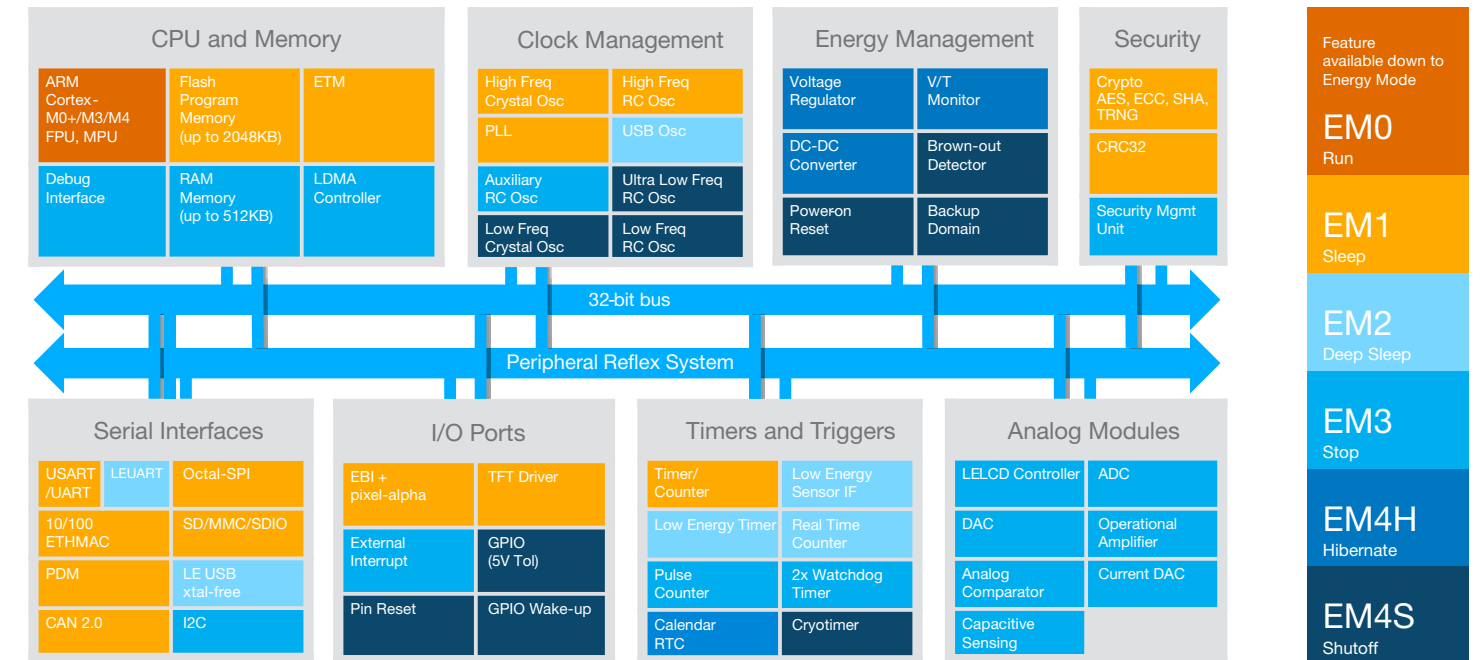

	EM0	EM1	EM2	EM3	EM4H	EM4S
Current consumption	40 - 225 uA/MHz	30 - 80 uA/MHz	0.9 - 2.1 uA	0.5 - 2.4 uA	0.15 - 0.94 uA	20 - 130 nA
Wake-up time	-	0	2 µs	2 µs	88 us	282 us
CPU	On	-	-	-	-	-
High frequency peripherals	Available	Available	-	-	-	-
Low frequency peripherals	Available	Available	Available	-	Calendar RTC	Cryotimer
Asynchronous peripherals	Available	Available	Available	Available	-	-
Full CPU and SRAM retention	On	On	On	On	-	-
Wake-up events	Any	Any	32 kHz peripherals and all EM3 wake-ups	Async IRQ, I2C slave, Analog comparators Voltage comparators	Reset, GPIO rising / falling edge	Reset, GPIO rising / falling edge

PRODUCT LINE	BASE PART NUMBER	PACKAGES	ARM CORTEX CPU	ACTIVE CURRENT (µA/MHz)	DEEP SLEEP CURRENT (µA)	FLASH (KB)	RAM (KB)	GPIO (PINS)	CRYPTOGRAPHY	USB	LCD (SEGMENTS)	ETH	SDIO	OSPI	USART/SPI (I2S)	UART/LEUART	I2C	CAN	TIMER (PWM)	LETIMER	RTC	PCNT	WATCHDOG	ADC (PINS)	DAC (PINS)	ACMP (PINS)	IDAC (PINS)	OPAMP	EBI	TFT	LESENSE
Zero Gecko	EFM32ZG	QFN24, QFN32, QFP48	M0+	114	0.9	4, 8, 16, 32	2, 4	17-37	AES128	-	-	-	-	-	1 (1)	- / 1	1	-	2 (6)	-	1	1	1	1 (4)	-	1 (5)	1	-	-	-	
Happy Gecko	EFM32HG	QFN24, QFN32, QFP48, CSP36	M0+	132	0.9	32, 64	4, 8	15-37	AES128	D	-	-	-	-	2 (1)	- / 1	1	-	3 (9)	-	1	1	1 (4)	-	1 (5)	1	-	-	-		
Tiny Gecko	EFM32TG	QFN24, QFN32, QFN64, QFP48, QFP64, BGA48	M3	150	1	4, 8, 16, 32	2, 4	17-56	AES128 / 256	-	1-8 x 11-24	-	-	-	2 (1)	- / 1	1	-	2 (6)	1	1	1	1 (8)	2 (2)	2 (16)	-	3	-	-	Y	
Gecko	EFM32G	QFN32, QFN64, QFP48, QFP64, QFP100, BGA112	M3	180	0.9	16, 32, 64, 128	8, 16	24-90	AES128 / 256	-	1-4 x 22-40	-	-	-	3	1 / 2	1	-	3 (9)	1	1	3	1	1 (8)	2 (2)	2 (16)	-	-	Y	-	
Leopard Gecko	EFM32LG	QFN64, QFP64, QFP100, BGA112, BGA120, CSP81	M3	211	0.95	64, 128, 256	32	50-93	AES128 / 256	D/H/O	1-8 x 16-36	-	-	-	3 (2)	2 / 2	2	-	4 (12)	1	1	3	1	1 (8)	2 (2)	2 (16)	-	3	Y	Y	Y
Giant Gecko	EFM32GG	QFN64, QFP64, QFP100, BGA112, BGA120	M3	219	1.1	512, 1024	128	50-93	AES128 / 256	D/H/O	1-8 x 16-36	-	-	-	3 (2)	2 / 2	2	-	4 (12)	1	1	2	1	1 (8)	2 (2)	2 (16)	-	3	Y	Y	Y
Wonder Gecko	EFM32WG	QFN64, QFP64, QFP100, BGA112, BGA120, CSP81	M4	225	0.95	64, 128, 256	32	50-93	AES128 / 256	D/H/O	1-8 x 16-36	-	-	-	3 (2)	2 / 2	2	-	4 (12)	1	1	3	1	1 (8)	2 (2)	2 (16)	-	3	Y	Y	Y
Jade Gecko	EFM32JG	QFN32, QFN48, BGA125	M3	64	1.5 - 2.5	128, 256, 1024	32, 256	20 - 65	FULL	-	-	-	-	-	4 / 4 (2)	- / 1	2	-	7 (3)	2	1	3	2	1 (58)	2 (56)	2 (56)	1 (26)	3	-	-	Y
Pearl Gecko	EFM32PG	QFN32, QFN48, BGA125	M4	64	1.5 - 2.5	128, 256, 1024	32, 256	20 - 65	FULL	-	-	-	-	-	4 / 4 (2)	- / 1	2	-	7 (3)	2	1	3	2	1 (58)	2 (56)	2 (56)	1 (26)	3	-	-	Y
Tiny Gecko S1	EFM32TG11B	QFN32, QFP48, QFN64, QFP64, QFN80, QFP80	M0+	40	1.3	64, 128	32	24 - 67	FULL	D/H/O	4-8 x 32-36	-	-	-	4 / 4 (2)	1 / 1	1	-	6 (4)	1	1	1	1	1 (46)	2 (24)	2 (46)	-	4	-	-	Y
Giant Gecko S1	EFM32GG11B EFM32GG12B	QFN64, QFP64, QFP100, BGA112, BGA120, BGA156, BGA192	M4	80	2.1	512, 1024, 2048	192, 384, 512	50 - 144	FULL	D/H/O	4-8 x 36-40	1 (10/100)	1	2	6 / 6 (3)	2 / 2	2	-	11 (4)	2	1	3	2	2 (68)	2 (24)	4 (68)	1 (30)	4	Y	Y	Y

To see our portfolio of wireless products visit silabs.com/wireless

Giant Gecko Series 1 32-bit Microcontrollers

For complex, battery-powered IoT applications, Silicon Labs' Giant Gecko Series 1 offers the most-integrated 32-bit MCU at the lowest energy level.

With a powerful Cortex-M4 at 72 MHz, up to 2MB of embedded flash and 512KB of RAM, and advanced peripherals like 10/100 Ethernet, Quad-SPI, LCD control, security accelerators, and more, the Giant Gecko 11 can help overcome challenging requirements of low-power sensing, controlling, and computing.

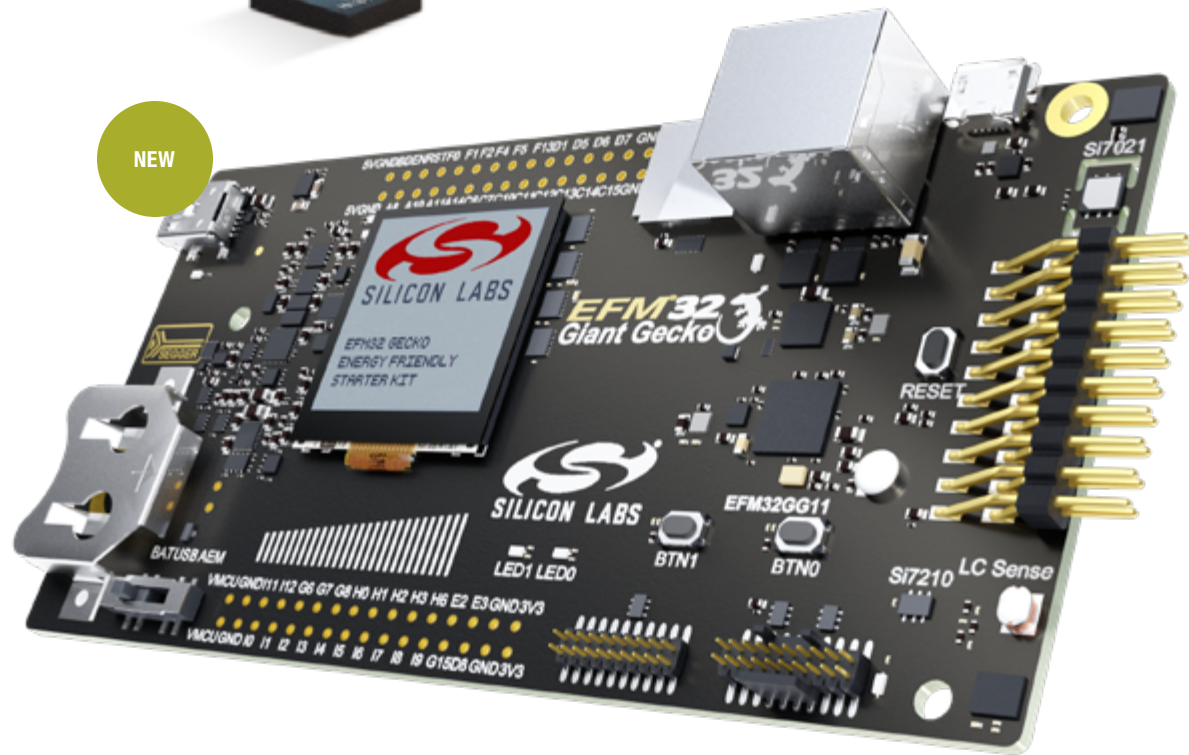

Minimize Energy Consumption

- Integrated high efficiency DC-DC
- 200 mA for both MCU and application
- Code execution at 80 μ A/MHz
- Sample sensors with ADC from deep sleep

Secure your IoT device

- Advanced built-in cryptography
- ECC / AES / RSA / SHA / CRC
- True Random Number Generator T (RNG)
- Unique Device Identifier

Maximize Capability

- Up to 2MB/512KB memory
- Advanced peripherals — QSPI/SDIO/Eth
- Display control of segment LCD and TFT
- Ready to use with Micrium OS

Efficient Integrated DC-DC Regulator

The Gecko MCUs include a highly efficient integrated DC-DC buck regulator, capable of supplying up to 200 mA to the MCU and surrounding IoT application. The regulator maintains its efficiency even when the system is in deep sleep.

The figure below illustrates one possible DC-DC configuration, driving both MCU and system components, in order to maximize energy efficiency.

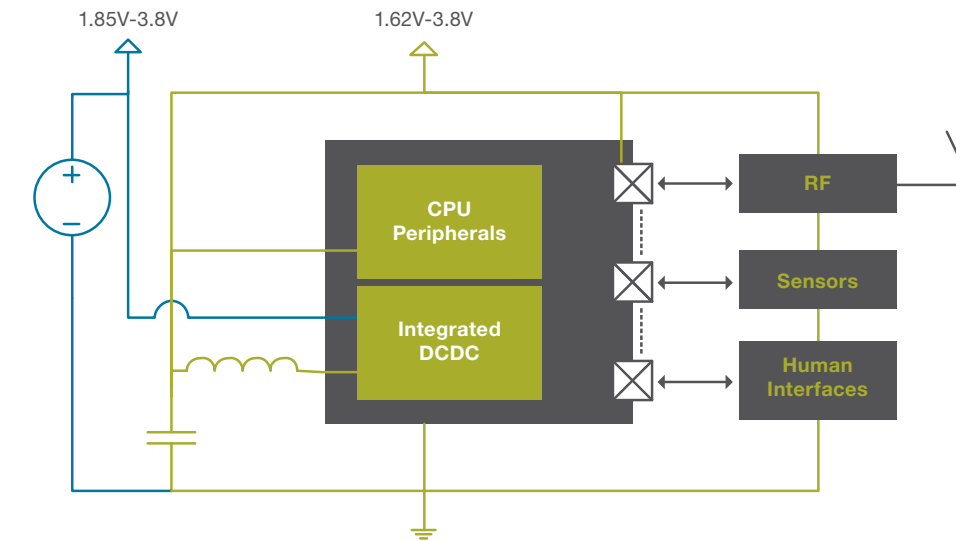

Typical DCDC Configurations

- Drive full system—maximum energy efficiency
- Drive MCU—IO and system at higher voltage
- Disabled—optimize BOM

Supply Ranges

- Efficient buck operation down to 2.4 V
- Seamless bypass from 2.4 V to 1.85 V
- MCU internals and IO range 1.62 V to 3.8 V

Flexibility

- Work with 1.8 V or 3.3 V system components
- Optimize for BOM or maximum efficiency
- Superior ease of use



IoT
Sensor nodes / Wireless modules



Industrial
Factory automation gateways

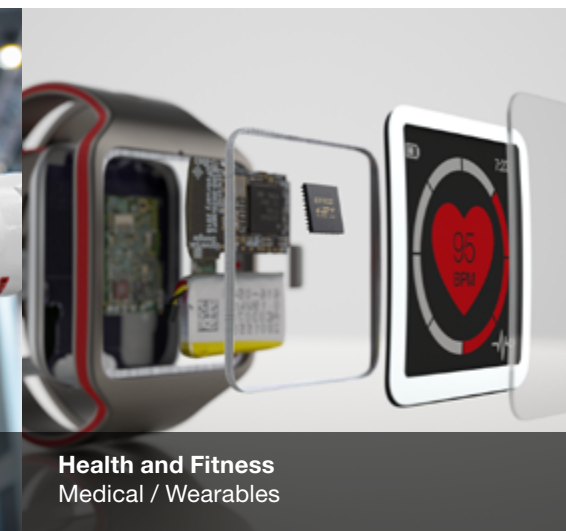

Health and Fitness
Medical / Wearables

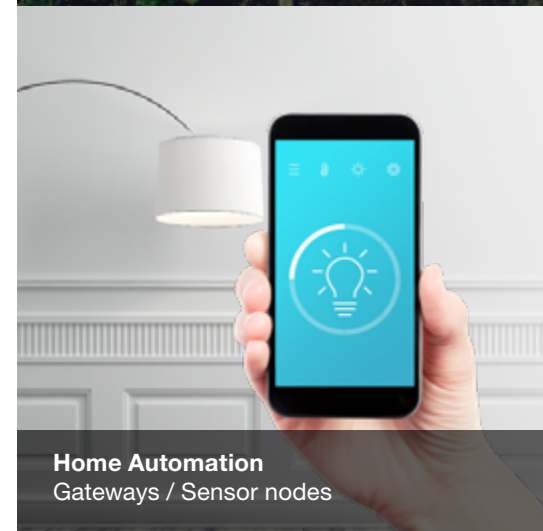

Home Automation
Gateways / Sensor nodes



Security
Smart door locks / Home security systems



Point of Sale
Mobile POS / Smart credit cards

Simplicity Studio

Simplicity Studio provides one-click access to design tools, documentation, software and support and resources for Gecko MCUs, EFM8™, 8051, Wireless Gecko MCUs and SoCs. Simplicity Studio 3.2 now features an enhanced real-time Energy Profiler, 3x faster execution speed and an easier, faster installation process.

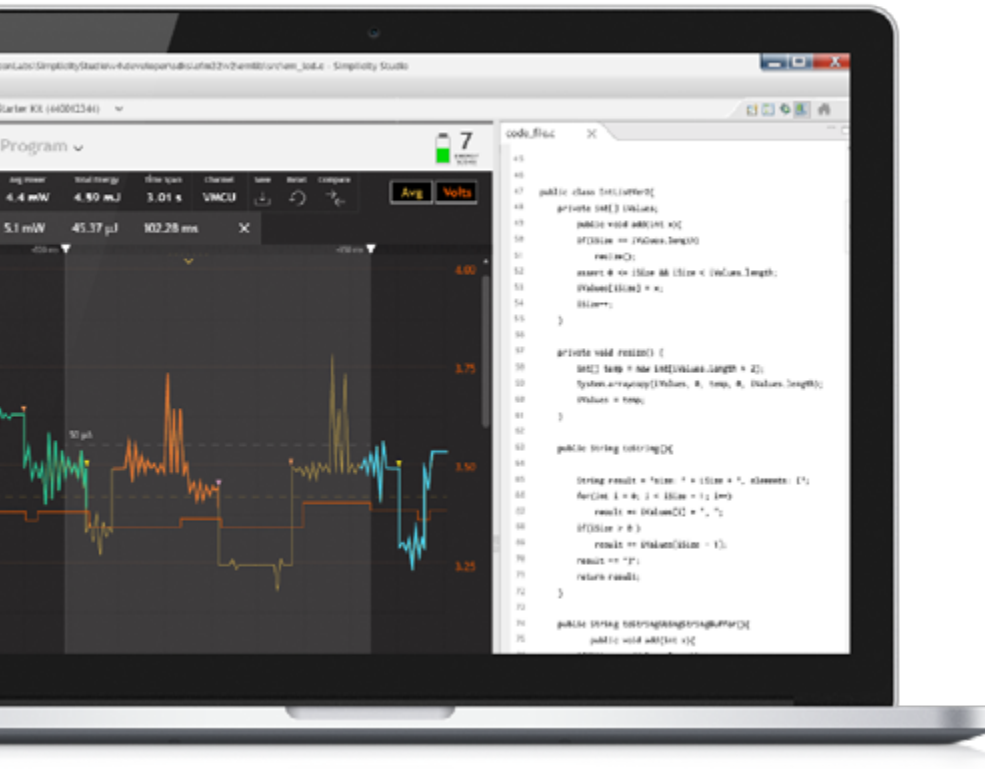

Energy Profiler

- Real-time analysis of energy consumption
- Correlate current consumption to code

Part Configurator

- Graphical configuration of peripherals and IO
- Automatic validation and code generation

IDE

- Eclipse framework
- Build tools: Keil®, IAR®, GCC
- 3rd party IDEs also supported

Documentation

- One-stop destination for all product documentation

Network Analyzer

- Advanced network debug for wireless products

Getting Started is Easy

1

Buy a Starter Kit

The easiest way to begin development

silabs.com/efm32

2

Download Simplicity Studio

Get up and running quickly with precompiled demos, application notes and examples.

silabs.com/simplicity

3

Connect with our Community

Explore, learn and share.

community.silabs.com



SILICON LABS

To buy or sample online, or find your nearest distributor, see details at silabs.com/efm32