

GaAs pHEMT MMIC LOW NOISE AMPLIFIER, DC - 20 GHz

Typical Applications

The HMC460LC5 is ideal for:

- Telecom Infrastructure
- Microwave Radio & VSAT
- Military & Space
- Test Instrumentation

Features

- Noise Figure: 2.5 dB @ 10 GHz
- Gain: 14 dB @ 10 GHz
- P1dB Output Power: +16.5 dBm @ 10 GHz
- Supply Voltage: +8V @ 75 mA
- 50 Ohm Matched Input/Output
- 32 Lead Ceramic 5 x 5 mm SMT Package: 25 mm²

Functional Diagram

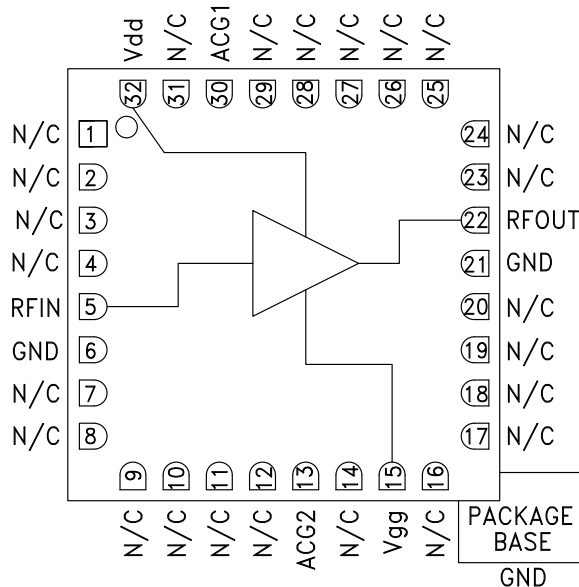

General Description

The HMC460LC5 is a GaAs MMIC pHEMT Low Noise Distributed Amplifier in a leadless 5 x 5 mm ceramic surface mount package which operates from DC to 20 GHz. The amplifier provides 14 dB of gain, 2.5 dB noise figure and +16.5 dBm of output power at 1 dB gain compression while requiring only 75 mA from a Vdd = 8V supply. Gain flatness is excellent from DC to 20 GHz making the HMC460LC5 ideal for EW, ECM, Radar and test equipment applications. The wideband amplifier I/Os are internally matched to 50 Ohms.

Electrical Specifications, $T_A = +25\text{ }^\circ\text{C}$, Vdd= 8V, Idd= 75 mA*

Parameter	Min.	Typ.	Max.	Min.	Typ.	Max.	Min.	Typ.	Max.	Units
Frequency Range		DC - 6.0		6.0 - 18.0			18.0 - 20.0			GHz
Gain	11	14		11	14		10	13		dB
Gain Flatness		± 0.5			± 0.15			± 0.25		dB
Gain Variation Over Temperature		0.008			0.01			0.01		dB/ °C
Noise Figure		3.5	5.0		2.5	4.0		3.5	5	dB
Input Return Loss		17			18			12		dB
Output Return Loss		17			15			15		dB
Output Power for 1 dB Compression (P1dB)	14	17		13	16		12	15		dBm
Saturated Output Power (Psat)		18			18			17		dBm
Output Third Order Intercept (IP3)		29.5			29			28.5		dBm
Supply Current (Idd) (Vdd= 8V, Vgg= -0.9V Typ.)		75			75			75		mA

*Adjust Vgg between -2 to 0V to achieve Idd= 75 mA typical.

**GaAs pHEMT MMIC LOW NOISE
AMPLIFIER, DC - 20 GHz**

Broadband Gain & Return Loss

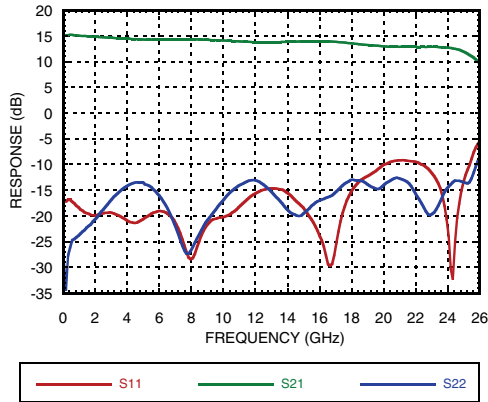

Gain vs. Temperature

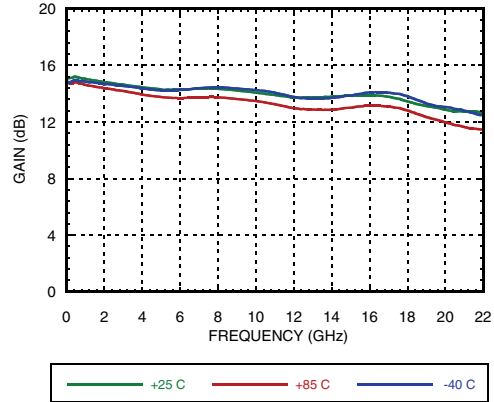

Input Return Loss vs. Temperature

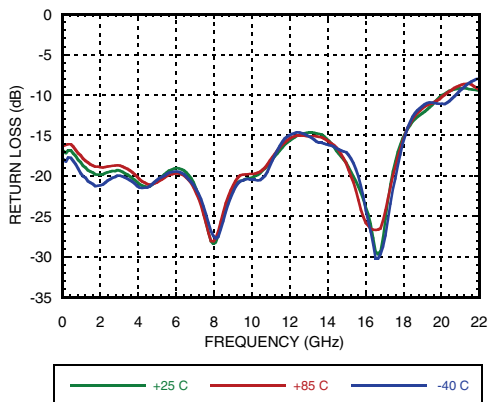

Output Return Loss vs. Temperature

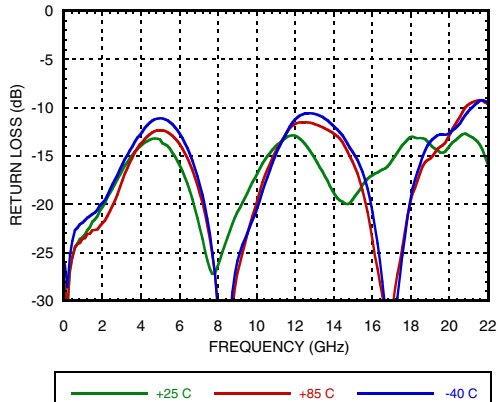

Low Frequency Gain & Return Loss

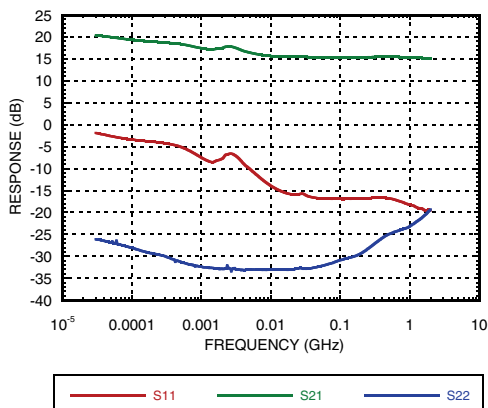

Noise Figure vs. Temperature

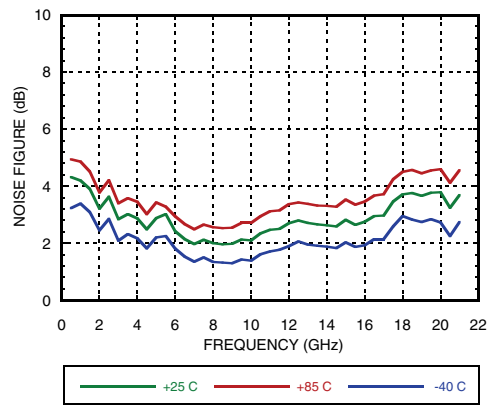

GaAs pHEMT MMIC LOW NOISE AMPLIFIER, DC - 20 GHz

P1dB vs. Temperature

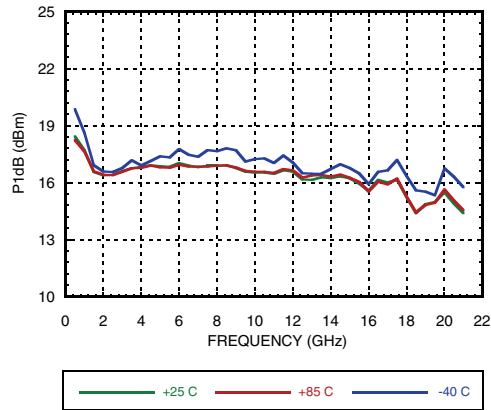

Psat vs. Temperature

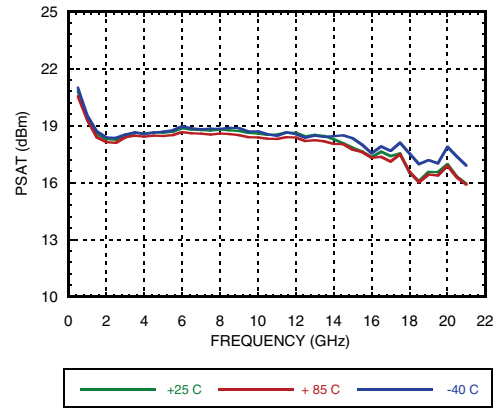

Output IP3 vs. Temperature

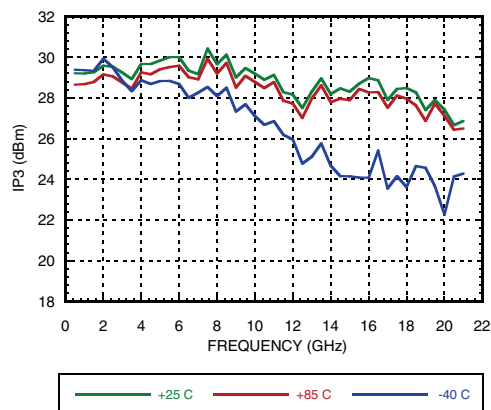

Gain, Power & Noise Figure vs. Supply Voltage @ 10 GHz, Fixed Vgg

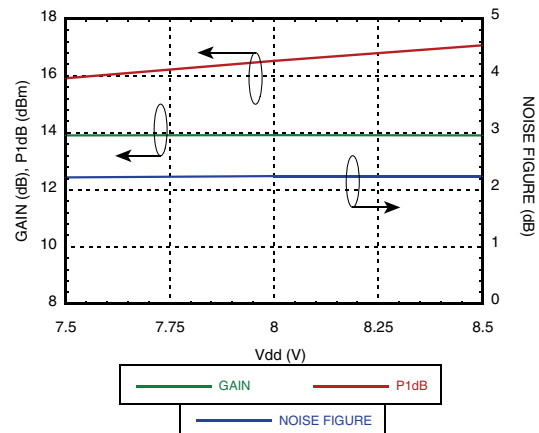

Reverse Isolation vs. Temperature

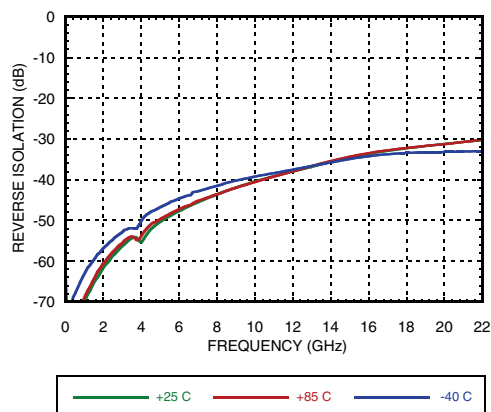

Additive Phase Noise Vs Offset Frequency, RF Frequency = 10 GHz, RF Input Power = 8 dBm (Psat)

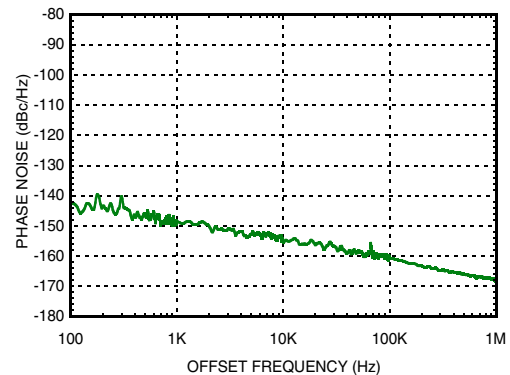

GaAs pHEMT MMIC LOW NOISE AMPLIFIER, DC - 20 GHz

Absolute Maximum Ratings

Drain Bias Voltage (Vdd)	+9 Vdc
Gate Bias Voltage (Vgg)	-2 to 0 Vdc
Gate Bias Voltage (Igg)	2.5 mA
RF Input Power (RFIN)(Vdd = +8 Vdc)	+18 dBm
Channel Temperature	175 °C
Continuous P _{diss} (T = 85 °C) (derate 23 mW/°C above 85 °C)	2 W
Thermal Resistance (channel to package bottom)	44.4 °C/W
Storage Temperature	-65 to +150 °C
Operating Temperature	-55 to +85 °C
ESD Sensitivity (HBM)	Class 1A

Typical Supply Current vs. Vdd

Vdd (V)	I _{dd} (mA)
+7.5	74
+8.0	75
+8.5	76



ELECTROSTATIC SENSITIVE DEVICE
OBSERVE HANDLING PRECAUTIONS

Outline Drawing

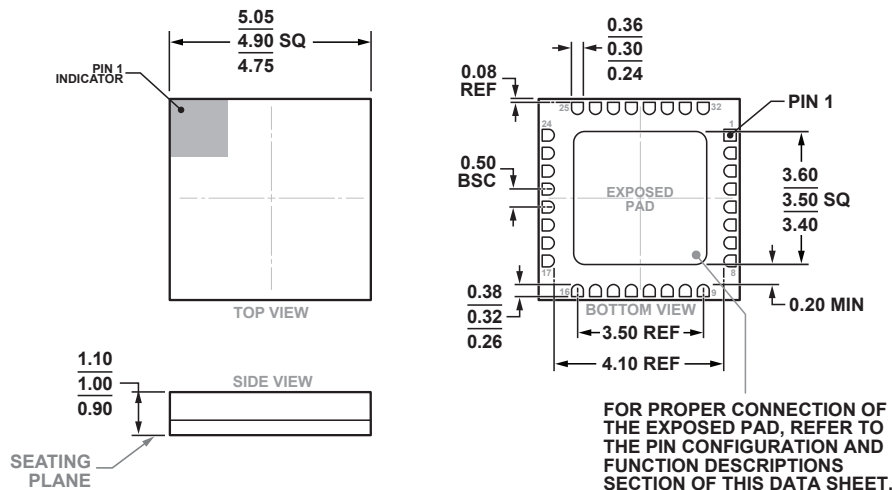

32-Terminal Ceramic Leadless Chip Carrier [LCC]
(E-32-1)

Dimensions shown in millimeters.

ORDERING GUIDE





Part Number	Package Material	Lead Finish	MSL Rating	Package Marking ^[2]
HMC460LC5	Alumina, White	Gold over Nickel	MSL3 ^[1]	H460 XXXX

[1] Max peak reflow temperature of 260 °C

[2] 4-Digit lot number XXXX

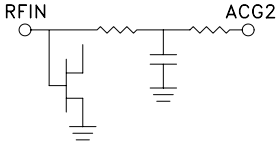
GaAs pHEMT MMIC LOW NOISE AMPLIFIER, DC - 20 GHz

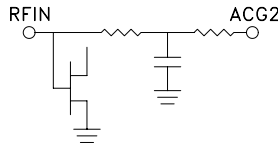
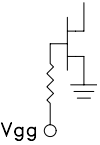
Pin Descriptions

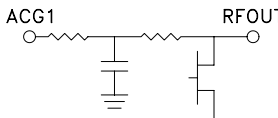
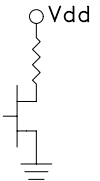
Pin Number	Function	Description	Interface Schematic
1 - 4, 7 - 12, 14, 16 - 20, 23 - 29, 31	N/C	No connection. These pins may be connected to RF ground. Performance will not be affected.	
5	RFIN	This pin is DC coupled and matched to 50 Ohms.	
6, 21	GND	Package bottom must be connected to RF/DC ground.	
13	ACG2	Low frequency termination. Attach bypass capacitor per application circuit herein.	
15	Vgg	Gate control for amplifier. Please follow "MMIC Amplifier Biasing Procedure" application note	
22	RFOUT	This pin is DC coupled and matched to 50 Ohms.	
30	ACG1	Low frequency termination. Attach bypass capacitor per application circuit herein.	
32	Vdd	Power supply voltage for the amplifier. External bypass capacitors are required	

**GaAs pHEMT MMIC LOW NOISE
AMPLIFIER, DC - 20 GHz**

Application Circuit

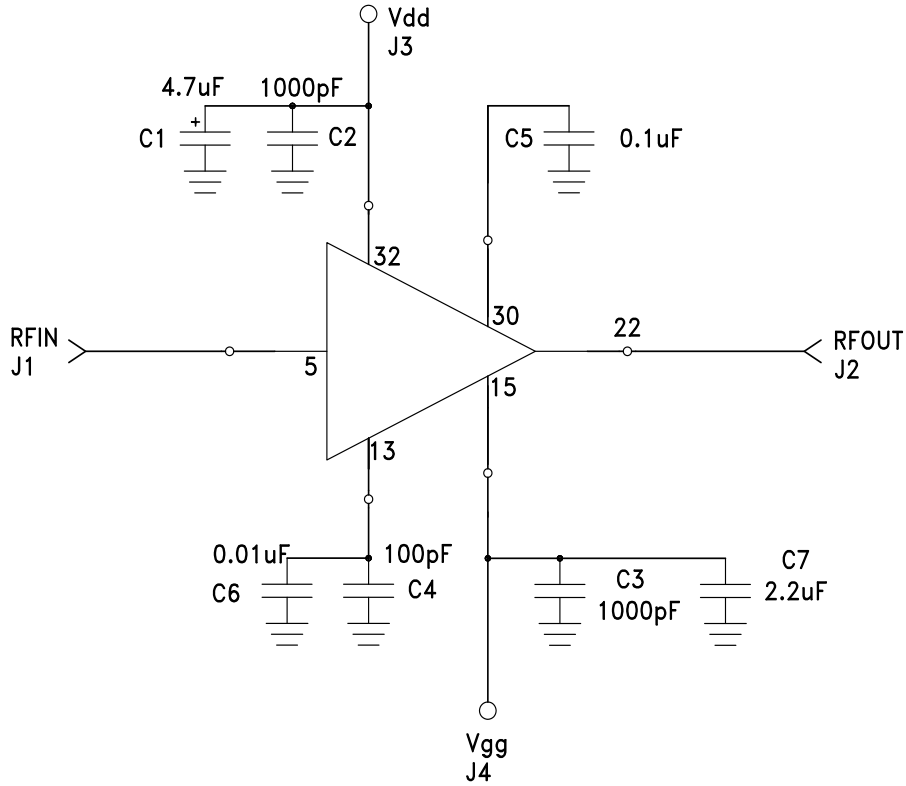

**GaAs pHEMT MMIC LOW NOISE
AMPLIFIER, DC - 20 GHz**

Evaluation PCB

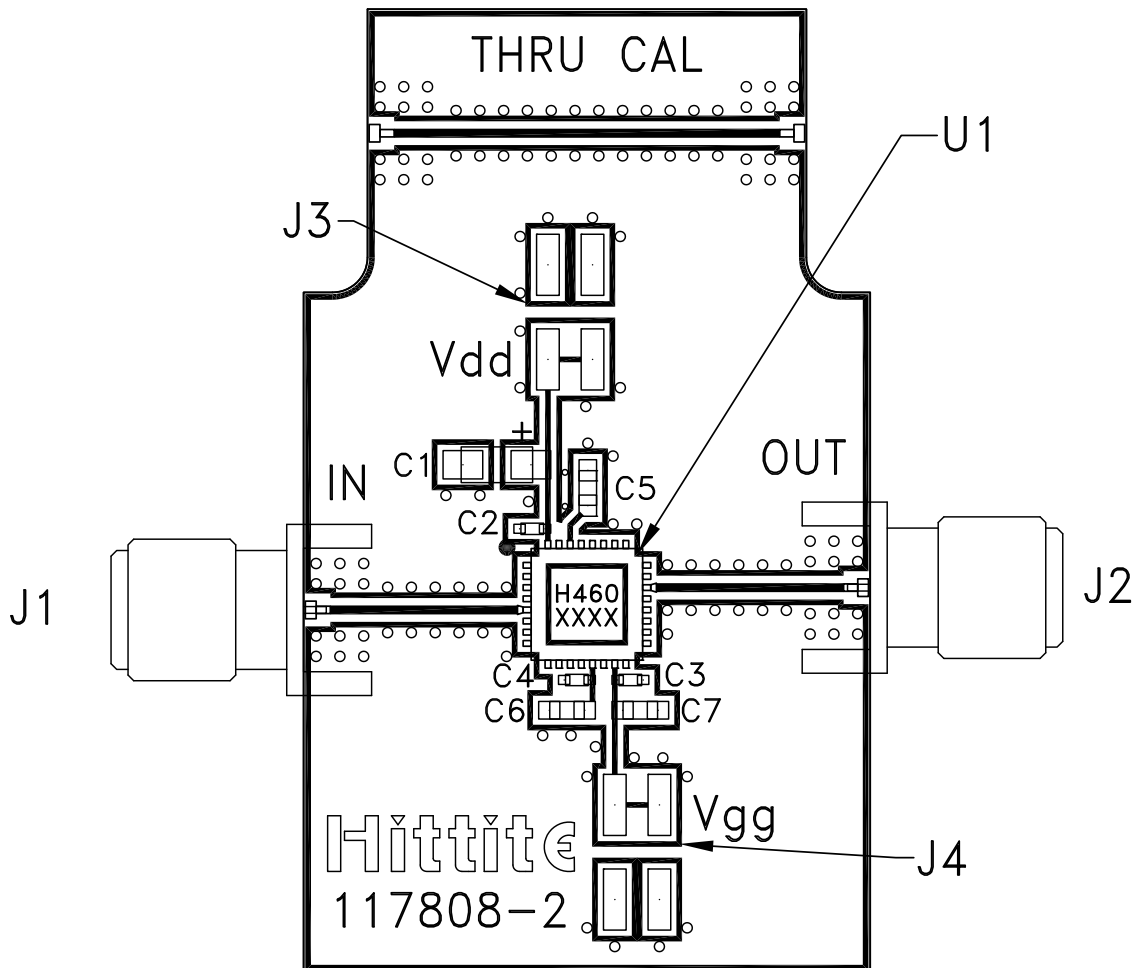

List of Materials for Evaluation PCB 117810 [1]

Item	Description
J1 - J2	PCB Mount SMA Connector
J3 - J4	2 mm Molex Header
C4	100 pF Capacitor, 0402 Pkg.
C2, C3	1000 pF Capacitor, 0402 Pkg.
C1	4.7 μ F Capacitor, Tantalum
C5	0.1 μ F Capacitor, 0603 Pkg.
C6	0.01 μ F Capacitor, 0603 Pkg.
C7	2.2 μ F Capacitor, 0603 Pkg.
U1	HMC460LC5
PCB [2]	117808 Evaluation PCB

[1] Reference this number when ordering complete evaluation PCB

[2] Circuit Board Material: Rogers 4350

The circuit board used in the application should use RF circuit design techniques. Signal lines should have 50 Ohm impedance while the package ground leads and package bottom should be connected directly to the ground plane similar to that shown. A sufficient number of via holes should be used to connect the top and bottom ground planes. The evaluation board should be mounted to an appropriate heat sink. The evaluation circuit board shown is available from Analog Devices upon request.