



# Standard Rectifier

$V_{RRM} = 2 \times 800 \text{ V}$

$I_{FAV} = 8 \text{ A}$

$V_F = 1.08 \text{ V}$

Phase leg

Part number

**DSP8-08AS**

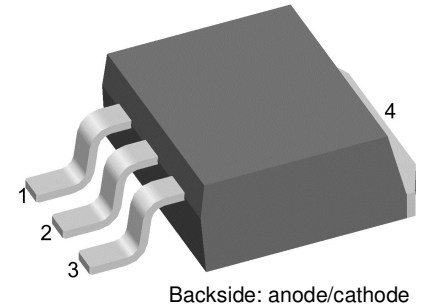

Backside: anode/cathode

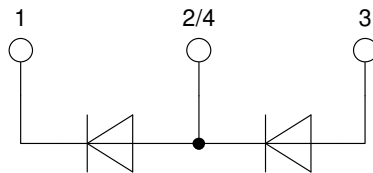

**Features / Advantages:**

- Planar passivated chips
- Very low leakage current
- Very low forward voltage drop
- Improved thermal behaviour

**Applications:**

- Diode for main rectification
- For single and three phase bridge configurations

**Package:** TO-263 (D2Pak)

- Industry standard outline
- RoHS compliant
- Epoxy meets UL 94V-0

**Disclaimer Notice**

Information furnished is believed to be accurate and reliable. However, users should independently evaluate the suitability of and test each product selected for their own applications. Littelfuse products are not designed for, and may not be used in, all applications. Read complete Disclaimer Notice at [www.littelfuse.com/disclaimer-electronics](http://www.littelfuse.com/disclaimer-electronics).



Rectifier				Ratings			
Symbol	Definition	Conditions		min.	typ.	max.	Unit
$V_{RSM}$	max. non-repetitive reverse blocking voltage					900	V
$V_{RRM}$	max. repetitive reverse blocking voltage					800	V
$I_R$	reverse current	$V_R = 800\text{ V}$		$T_{VJ} = 25^\circ\text{C}$		10	$\mu\text{A}$
		$V_R = 800\text{ V}$		$T_{VJ} = 150^\circ\text{C}$		0.2	mA
$V_F$	forward voltage drop	$I_F = 8\text{ A}$		$T_{VJ} = 25^\circ\text{C}$		1.16	V
		$I_F = 16\text{ A}$				1.35	V
		$I_F = 8\text{ A}$		$T_{VJ} = 150^\circ\text{C}$		1.08	V
		$I_F = 16\text{ A}$				1.34	V
$I_{FAV}$	average forward current	$T_C = 160^\circ\text{C}$		$T_{VJ} = 175^\circ\text{C}$		8	A
		rectangular	$d = 0.5$				
$V_{F0}$	threshold voltage			$T_{VJ} = 175^\circ\text{C}$		0.79	V
$r_F$	slope resistance					33	m $\Omega$
$R_{thJC}$	thermal resistance junction to case					1.5	K/W
$R_{thCH}$	thermal resistance case to heatsink				0.3		K/W
$P_{tot}$	total power dissipation			$T_C = 25^\circ\text{C}$		100	W
$I_{FSM}$	max. forward surge current	$t = 10\text{ ms}; (50\text{ Hz}), \text{ sine}$		$T_{VJ} = 45^\circ\text{C}$		120	A
		$t = 8,3\text{ ms}; (60\text{ Hz}), \text{ sine}$		$V_R = 0\text{ V}$		130	A
		$t = 10\text{ ms}; (50\text{ Hz}), \text{ sine}$		$T_{VJ} = 150^\circ\text{C}$		100	A
		$t = 8,3\text{ ms}; (60\text{ Hz}), \text{ sine}$		$V_R = 0\text{ V}$		110	A
$I^2t$	value for fusing	$t = 10\text{ ms}; (50\text{ Hz}), \text{ sine}$		$T_{VJ} = 45^\circ\text{C}$		72	A <sup>2</sup> s
		$t = 8,3\text{ ms}; (60\text{ Hz}), \text{ sine}$		$V_R = 0\text{ V}$		70	A <sup>2</sup> s
		$t = 10\text{ ms}; (50\text{ Hz}), \text{ sine}$		$T_{VJ} = 150^\circ\text{C}$		50	A <sup>2</sup> s
		$t = 8,3\text{ ms}; (60\text{ Hz}), \text{ sine}$		$V_R = 0\text{ V}$		50	A <sup>2</sup> s
$C_J$	junction capacitance	$V_R = 400\text{ V}; f = 1\text{ MHz}$		$T_{VJ} = 25^\circ\text{C}$		4	pF



Package TO-263 (D2Pak)			Ratings			
Symbol	Definition	Conditions	min.	typ.	max.	Unit
$I_{RMS}$	RMS current	per terminal			25	A
$T_{VJ}$	virtual junction temperature		-55		175	°C
$T_{op}$	operation temperature		-55		150	°C
$T_{stg}$	storage temperature		-55		150	°C
<b>Weight</b>				2		g
$F_C$	mounting force with clip		20		60	N

**Product Marking**

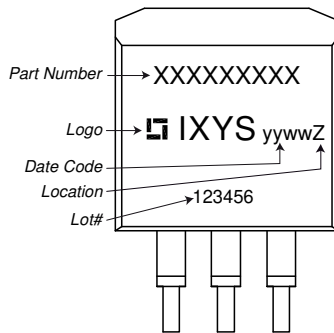

Ordering	Ordering Number	Marking on Product	Delivery Mode	Quantity	Code No.
Standard	DSP8-08AS-TRL	DSP8-08AS-TRL	Tape & Reel	800	504315
Alternative	DSP8-08AS-TUB	DSP8-08AS	Tube	50	465445

Similar Part	Package	Voltage class
DSP8-08S	TO-263AB (D2Pak) (2)	800
DSP8-08A	TO-220AB (3)	800
DSP8-12AS	TO-263AA (D2Pak) (3)	1200
DSP8-12S	TO-263AB (D2Pak) (2)	1200

DSP8-12A	TO-220AB (3)	1200
DSP8-12AC	ISOPLUS220AB (3)	1200

**Equivalent Circuits for Simulation**

\* on die level

$T_{VJ} = 175^{\circ}C$



**Rectifier**

$V_{0\ max}$	threshold voltage	0.79	V
$R_{0\ max}$	slope resistance *	30	mΩ



**Outlines TO-263 (D2Pak)**

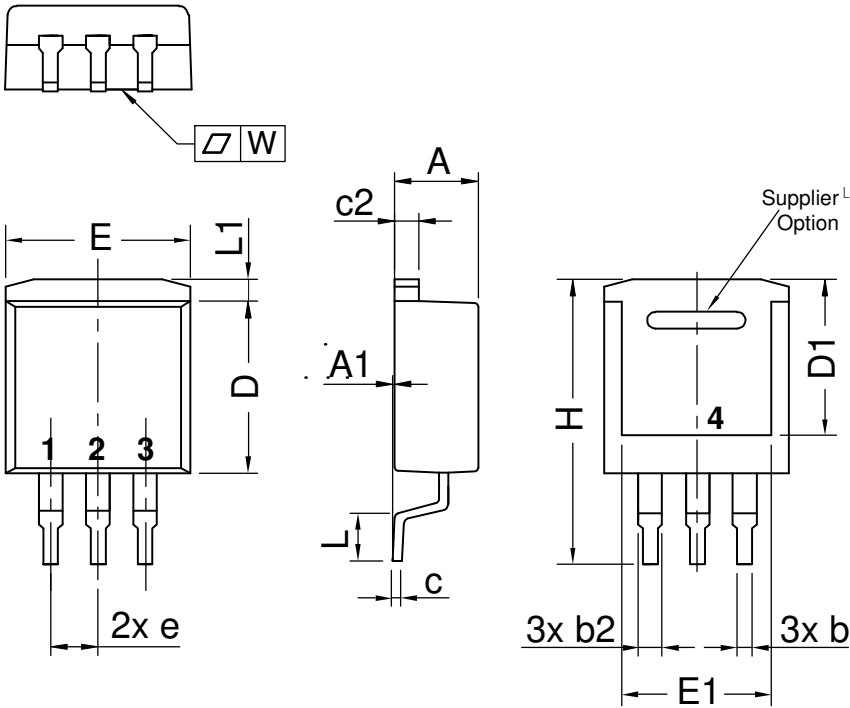

Dim.	Millimeter		Inches	
	min	max	min	max
A	4.06	4.83	0.160	0.190
A1	typ. 0.10		typ. 0.004	
A2	2.41		0.095	
b	0.51	0.99	0.020	0.039
b2	1.14	1.40	0.045	0.055
c	0.40	0.74	0.016	0.029
c2	1.14	1.40	0.045	0.055
D	8.38	9.40	0.330	0.370
D1	8.00	8.89	0.315	0.350
D2	2.5		0.098	
E	9.65	10.41	0.380	0.410
E1	6.22	8.50	0.245	0.335
e	2,54 BSC		0,100 BSC	
e1	4.28		0.169	
H	14.61	15.88	0.575	0.625
L	1.78	2.79	0.070	0.110
L1	1.02	1.68	0.040	0.066
W	typ. 0.02	0.040	typ. 0.0008	0.002

*All dimensions conform with and/or within JEDEC standard.*

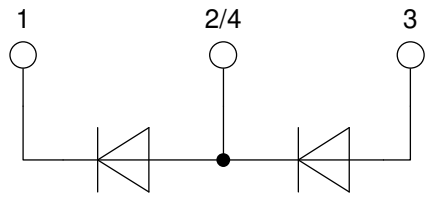

**Rectifier**

Fig. 1 Forward current versus voltage drop per diode

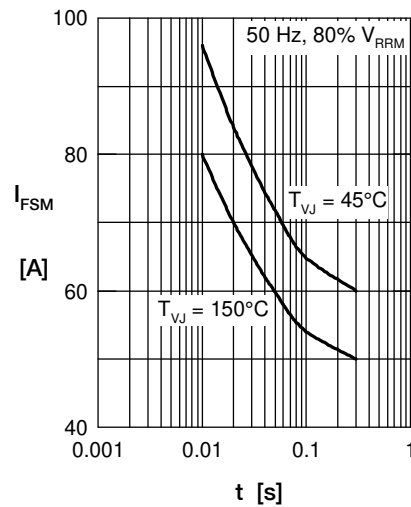

Fig. 2 Surge overload current

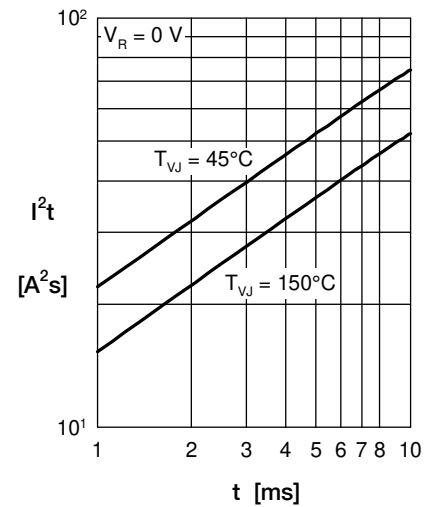
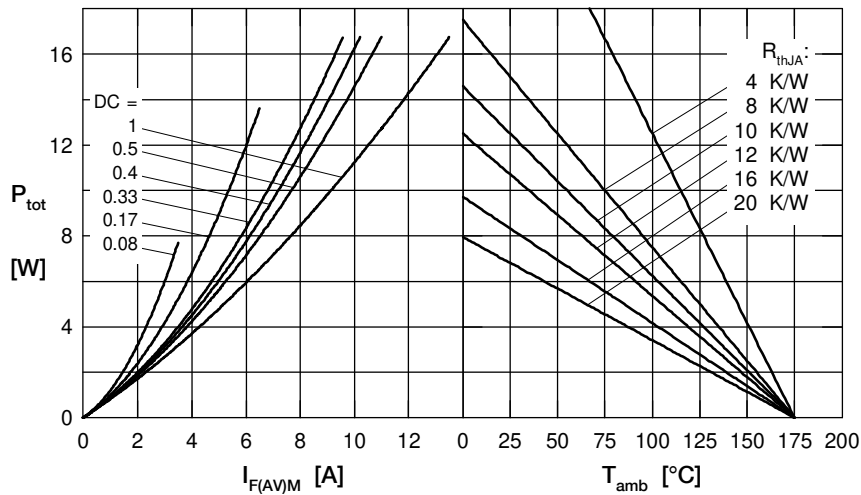

 Fig. 3  $I^2t$  versus time per diode

Fig. 4 Power dissipation vs. direct output current and ambient temperature

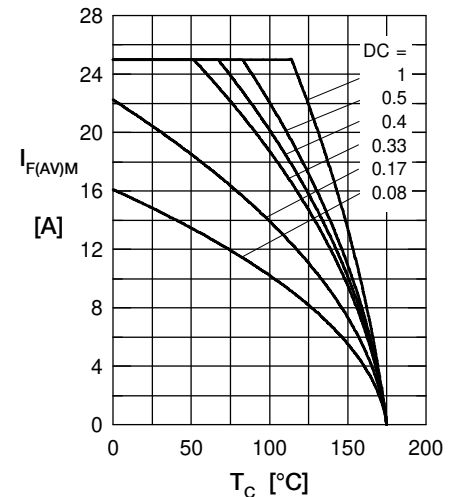

Fig. 5 Max. forward current vs. case temperature

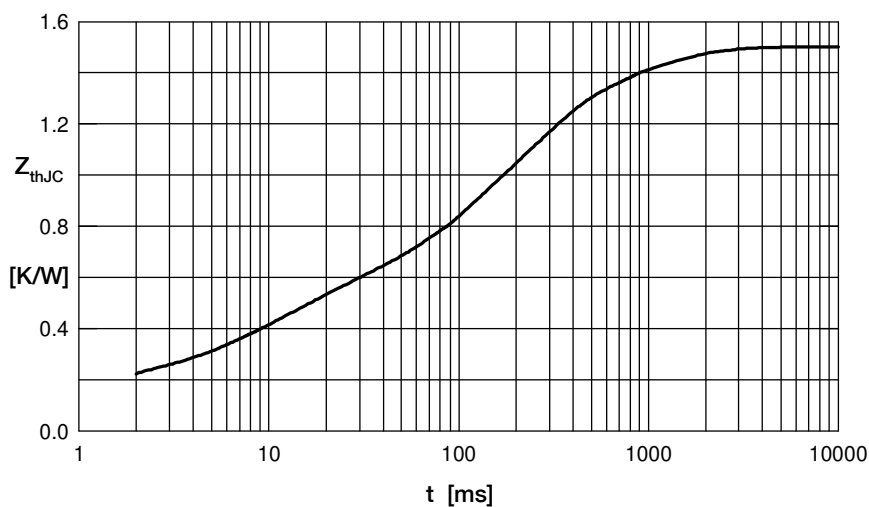

Fig. 6 Transient thermal impedance junction to case

 Constants for  $Z_{thJC}$  calculation:

i	$R_{thi}$ (K/W)	$t_i$ (s)
1	0.155	0.0005
2	0.332	0.0095
3	0.713	0.17
4	0.3	0.8
5	0.00001	0.00001