



**SPECIFICATION  
FOR  
LCD MODULE**

**MODULE NO: AFY240320A0-2.8INTH  
REVISION NO: O**

Customer's Approval:

--

	SIGNATURE	DATE
PREPARED BY (RD ENGINEER)		
CHECKED BY		
APPROVED BY		



## CONTENTS

<b>1. GENERAL INFORMATION .....</b>	<b>3</b>
<b>2. ABSOLUTE MAXIMUM RATINGS.....</b>	<b>3</b>
<b>3. ELECTRICAL CHARACTERISTICS.....</b>	<b>3</b>
<b>4. BACKLIGHT CHARACTERISTICS .....</b>	<b>4</b>
<b>5. EXTERNAL DIMENSIONS .....</b>	<b>5</b>
<b>6. ELECTRO-OPTICAL CHARACTERISTICS.....</b>	<b>6</b>
<b>7. INTERFACE DESCRIPTION.....</b>	<b>8</b>
<b>8.AC CHARACTERISTICS .....</b>	<b>9</b>
<b>9. POWER SEQUENCE.....</b>	<b>14</b>
<b>10. RELIABILITY TEST CONDITIONS.....</b>	<b>15</b>
<b>11.INSPECTION CRITERION .....</b>	<b>16</b>
<b>12. HANDLING PRECAUTIONS .....</b>	<b>23</b>
<b>13. PRECAUTION FOR USE.....</b>	<b>24</b>
<b>14. PACKING SPECIFICATION.....</b>	<b>24</b>
<b>15. INITIALIZATION CODE .....</b>	<b>24</b>
<b>16. HSF COMPLIANCE .....</b>	<b>26</b>

## 1. GENERAL INFORMATION

No.	Item	Contents	Unit
1	LCD size	2.8 inch (Diagonal)	/
2	Display mode	Normally black/Transmissive/Anti-glare	/
3	Viewing direction(eye)	FREE	/
4	Gray scale inversion direction	-	/
5	Resolution(H*V)	240 *320 Pixels	/
6	Module size (L*W*H)	50.0*69.20*2.39	mm
7	Active area (L*W)	43.20*57.60	mm
8	Pixel pitch (L*W)	0.180*0.180	mm
9	Interface type	RGB interface	/
10	Color Depth	16.7M	/
11	Module power consumption	TBD	W
12	Back light type	LED	/
13	Driver IC	ST7789V or compatible	/
14	Weight	TBD	g

## 2. ABSOLUTE MAXIMUM RATINGS

Item	Symbol	Min.	Max.	Unit	Note
Power supply input voltage for TFT	VDD	-0.3	4.6	V	
Backlight current (normal temp.)	ILED	-	125	mA	
Operation temperature	Top	-20	+70	°C	Note1
Storage temperature	Tst	-30	+80	°C	Note1
Humidity	RH	-	90%(Max60 °C)	RH	Note1

Note1 :

- 1).The relative humidity and temperature range are as below sketch,90%RH Max.
- 2).The maximum wet bulb temperature  $\leq 40^{\circ}\text{C}$  and without dewing.

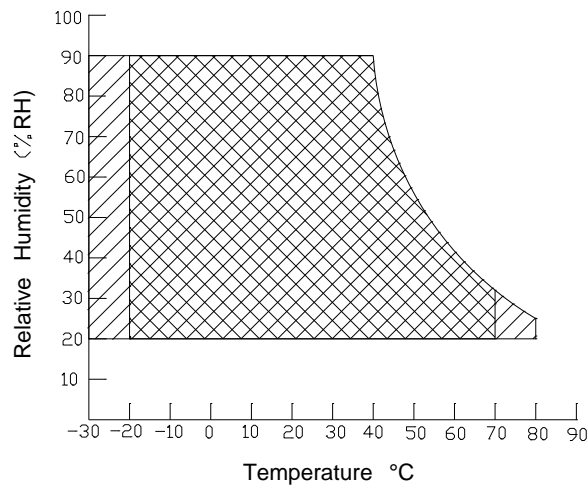

Operating Range  Storage Range  + 

## 3. ELECTRICAL CHARACTERISTICS

### DC CHARACTERISTICS(at Ta=25°C)

Item	Symbol	Min.	Typ.	Max.	Unit	Note
Power supply input voltage	VCC	2.65	2.8	3.3	V	
I/O logic voltage	VDDIO	-	1.8	-	V	=VCC
Input voltage 'H' level	VIH	0.7VDDIO	-	VDDIO	V	
Input voltage 'L' level	VIL	VSS	-	0.3VDDIO	V	
Power supply current	IVDD	-	9	-	mA	

## 4. BACKLIGHT CHARACTERISTICS

(at Ta=25°C,RH=60%)

Item	Symbol	Min.	Typ.	Max.	Unit	Note
LED forward voltage	VF	5.8	6.0	6.4	V	IF=20*4mA
LED forward current	IF	-	100	-	mA	
LED power consumption	PLED	-	0.60	-	W	Note1
Number of LED	-		5		PCS	
Connection mode	-	5 in parallel			/	
LED life-time	-	20000	-	-	Hrs	Note2

Note1 : Calculator value for reference :  $IF \cdot VF = PLED$

Note2 : The LED life-time define as the estimated time to 50% degradation of initial brightness at Ta=25°C and IF =100mA. The LED lifetime could be decreased if operating IF is larger than 80mA.



## 6. ELECTRO-OPTICAL CHARACTERISTICS

Item	Symbol	Condition	Min.	Typ.	Max.	Unit	Remark	Note
Response time	Tr+ Tf	-	-	35	45	ms	FIG.1	Note 1
Contrast ratio	Cr		600	800	-	-	FIG.2	Note 2
Surface luminance	Lv	$\theta=0^\circ$	800	1000	-	cd/m <sup>2</sup>	FIG.2	Note 3
Luminance uniformity	Yu	$\theta=0^\circ$	75	80	-	%	FIG.2	Note 4
NTSC	-	$\theta=0^\circ$	-	50	-	%	FIG.2	Note 5
Viewing angle	$\theta$	$\varnothing=90^\circ$	70	80	-	deg	FIG.3	Note 6
		$\varnothing=270^\circ$	70	80	-	deg	FIG.3	
		$\varnothing=0^\circ$	70	80	-	deg	FIG.3	
		$\varnothing=180^\circ$	70	80	-	deg	FIG.3	
CIE (x,y) chromaticity	Red x	$\theta=0^\circ$ $\varnothing=0^\circ$ $T_a=25^\circ\text{C}$	Typ -0.04	TBD	Typ +0.04	-	FIG.2 CIE1931	Note 5
	Red y			TBD		-		
	Green x			TBD		-		
	Green y			TBD		-		
	Blue x			TBD		-		
	Blue y			TBD		-		
	White x			TBD		-		
	White y			TBD		-		

### Note1. Definition of response time

The response time is defined as the LCD optical switching time interval between “White” state and “Black”state. Rise time ( $T_{ON}$ ) is the time between photo detector output intensity changed from 90% to 10%. And fall time ( $T_{OFF}$ ) is the time between photo detector output intensity changed from 10% to 90%. For additional information see FIG1.

### Note2. Definition of contrast ratio

Contrast ratio(Cr) is defined mathematically by the following formula. For more information see FIG.2.

$$\text{Contrast ratio} = \frac{\text{Luminance measured when LCD on the "White" state}}{\text{Luminance measured when LCD on the "Black" state}}$$

Measured at the center area of the LCD

### Note3. Definition of surface luminance

Surface luminance is the luminance with all pixels displaying white. For more information see FIG.2.

$$L_v = \text{Average Surface Luminance with all white pixels}(P_1, P_2, P_3, \dots, P_n)$$

### Note4. Definition of luminance uniformity

The luminance uniformity in surface luminance is determined by measuring luminance at each test position 1 through n, and then dividing the maximum luminance of n points luminance by minimum luminance of n points luminance. For more information see FIG.2.

$$Y_u = \frac{\text{Minimum surface luminance with all white pixels } (P_1, P_2, P_3, \dots, P_n)}{\text{Maximum surface luminance with all white pixels } (P_1, P_2, P_3, \dots, P_n)}$$

### Note5. Definition of color chromaticity (CIE1931)

CIE (x,y) chromaticity, The x,y value is determined by screen active area center position P5. For more information see FIG.2.

### Note6. Definition of viewing angle

Viewing angle is the angle at which the contrast ratio is greater than 10. angles are determined for the horizontal or x axis and the vertical or y axis with respect to the z axis which is normal to the LCD surface. For more information see FIG.3.

For viewing angle and response time testing, the testing data is base on Autronic-Melchers's ConoScope or DMS series Instruments or compatible. For contrast ratio, Surface Luminance, Luminance uniformity and CIE, the testing data is base on TOPCON's BM-5 or BM-7 photo detector or compatible.

**FIG.1. The definition of response Time**

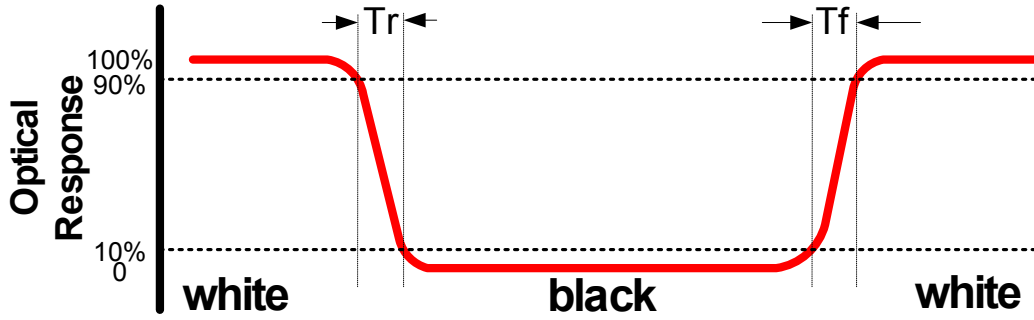

**FIG.2. Measuring method for contrast ratio, surface luminance, luminance uniformity, CIE (x,y) chromaticity**

H,V : Active area

Light spot size  $\varnothing=5\text{mm}$ (BM-5) or  $\varnothing=7.7\text{mm}$  (BM-7)50cm distance or compatible distance from the LCM surface to detector lens.

Test spot position : see Figure a.

measurement instrument : TOPCON's luminance meter BM-5 or BM-7 or compatible ,see Figure b.

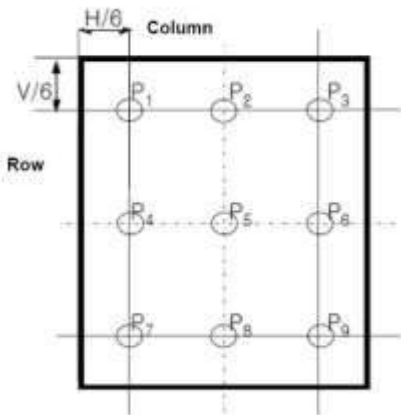

Figure a

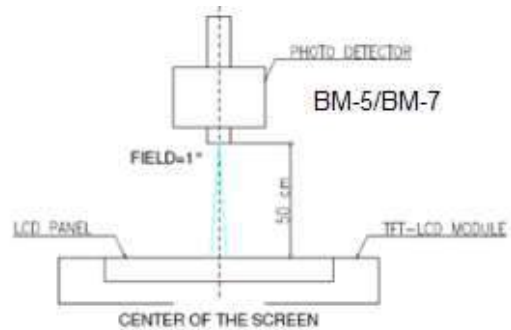
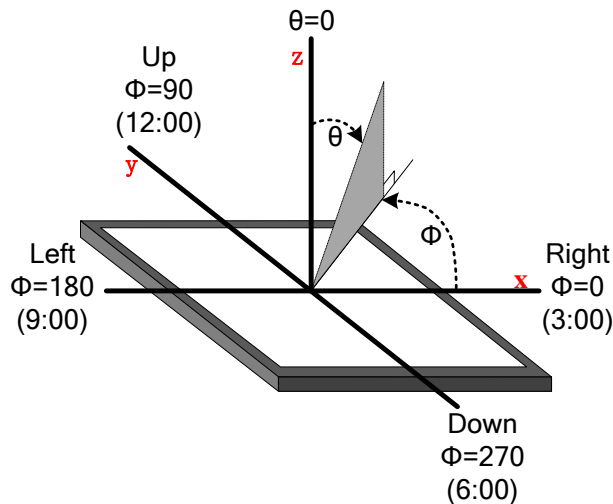

Figure b

**FIG.3. The definition of viewing angle**





## 7. INTERFACE DESCRIPTION

### Module Interface description

Interface No.	Name	I/O or connect to	Description
1	LEDK	P	Power for LED backlight(Cathode).
2	LEDA	P	Power for LED backlight(Anode).
3	GND	P	Power Ground.
4	NC	/	
5	NC	/	
6	NC	/	
7	SDA	I/O	SPI data input pin.
8	DOTCLK	I	Dot clock signal.
9	DE	I	Data enable.
10	VSYNC	I	Vertical sync input
11	HSYNC	I	Horizontal sync input
12	VCC	P	Power supply
13	RESET	I	Reset signal.
14	GND	P	Power Ground.
<b>15-32</b>	<b>DB17-DB0</b>	<b>I/O</b>	<b>Data bus (DB17--DB0).</b>
33	RD	I	RGB Interface.please fix this pin at VCC or DGND.
34	WR	I	RGB Interface.please fix this pin at VCC or GND.
35	RS	I	RGB Interface. serial interface clock.
36	CS	I	Chip selection pin. Low enable.
37	XR(NC)	/	X-Right
38	YD(NC)	/	Y-Up
39	XL(NC)	/	X-Left
40	YU(NC)	/	Y-Bottom

## 8. AC CHARACTERISTICS

### Display Parallel 18/16/9/8-bit Interface Timing Characteristics (8080)

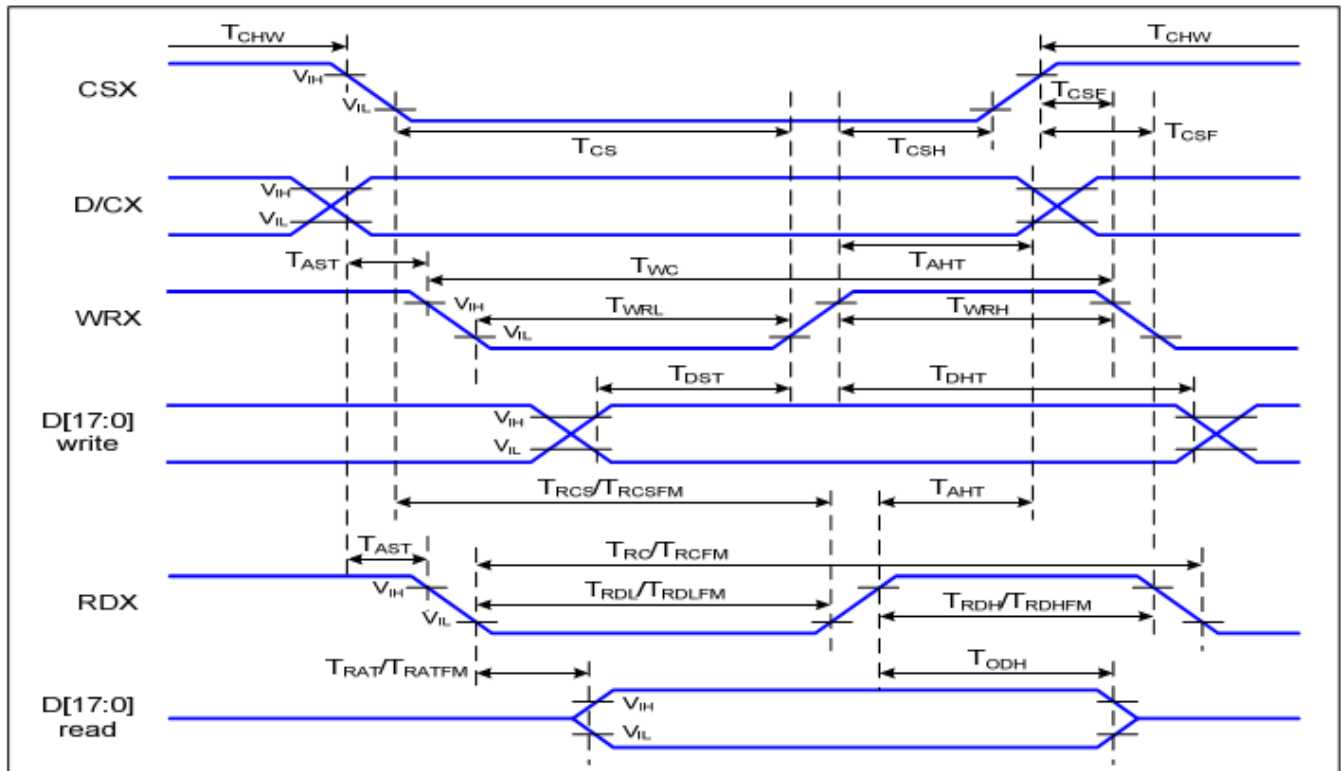

Figure 1 Parallel Interface Timing Characteristics (8080-Series MCU Interface)

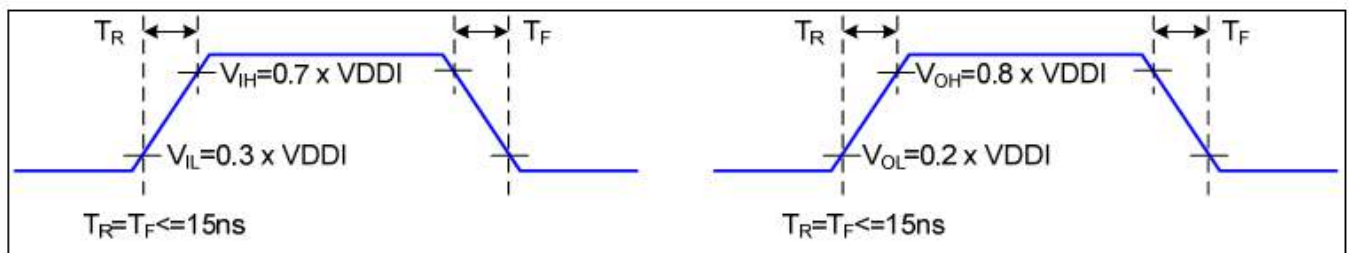

Figure 2 Rising and Falling Timing for I/O Signal

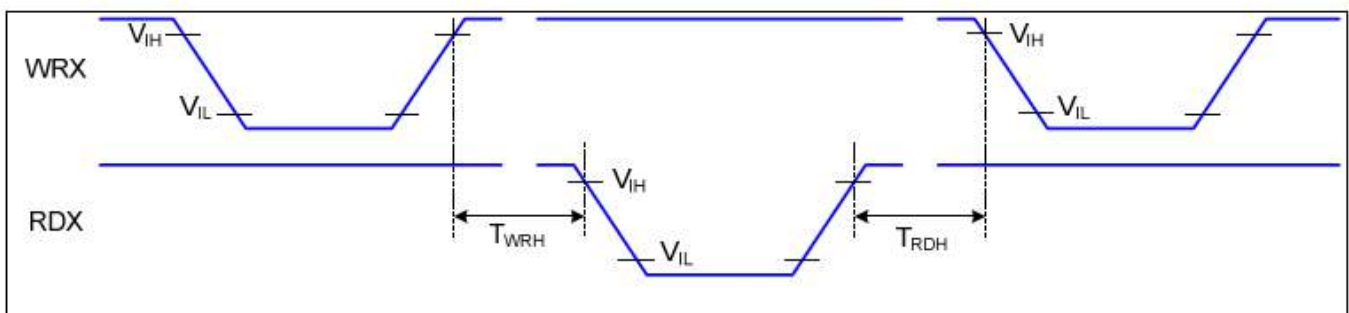

Figure 3 Write-to-Read and Read-to-Write Timing

Signal	Symbol	Parameter	Min	Max	Unit	Description
D/CX	T <sub>AST</sub>	Address setup time	0		ns	
	T <sub>AHT</sub>	Address hold time (Write/Read)	10		ns	
CSX	T <sub>CHW</sub>	Chip select "H" pulse width	0		ns	
	T <sub>CS</sub>	Chip select setup time (Write)	15		ns	
	T <sub>RCS</sub>	Chip select setup time (Read ID)	45		ns	
	T <sub>RCSFM</sub>	Chip select setup time (Read FM)	355		ns	
	T <sub>CSF</sub>	Chip select wait time (Write/Read)	10		ns	
	T <sub>CSH</sub>	Chip select hold time	10		ns	
WRX	T <sub>WC</sub>	Write cycle	66		ns	
	T <sub>WRH</sub>	Control pulse "H" duration	15		ns	
	T <sub>WRL</sub>	Control pulse "L" duration	15		ns	
RDX (ID)	T <sub>RC</sub>	Read cycle (ID)	160		ns	When read ID data
	T <sub>RDH</sub>	Control pulse "H" duration (ID)	90		ns	
	T <sub>RDL</sub>	Control pulse "L" duration (ID)	45		ns	
RDX (FM)	T <sub>RCFM</sub>	Read cycle (FM)	450		ns	When read from frame memory
	T <sub>RDHFM</sub>	Control pulse "H" duration (FM)	90		ns	
	T <sub>RDLFM</sub>	Control pulse "L" duration (FM)	355		ns	
D[17:0]	T <sub>DST</sub>	Data setup time	10		ns	For CL=30pF
	T <sub>DHT</sub>	Data hold time	10		ns	
	T <sub>RAT</sub>	Read access time (ID)		40	ns	
	T <sub>RATFM</sub>	Read access time (FM)		340	ns	
	T <sub>ODH</sub>	Output disable time	20	80	ns	

## Display Serial Interface Timing Characteristics (3-line SPI system)

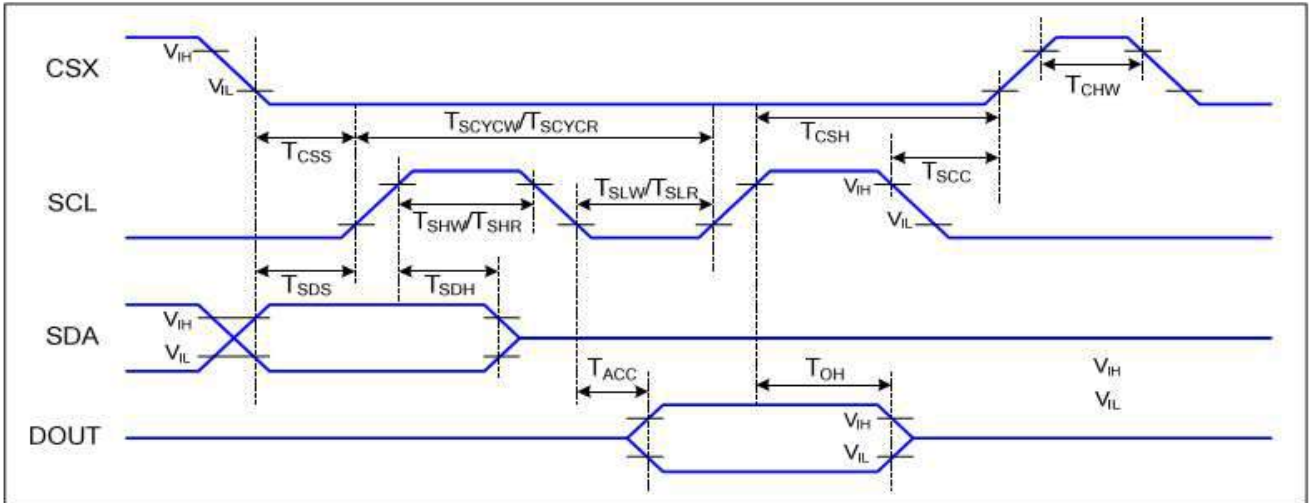

Figure 4 3-line serial Interface Timing Characteristics

VDDI=1.65 to 3.3V, VDD=2.4 to 3.3V, AGND=DGND=0V, Ta=-30 to 70 °C

Signal	Symbol	Parameter	Min	Max	Unit	Description
CSX	T <sub>CSS</sub>	Chip select setup time (write)	15		ns	
	T <sub>CSH</sub>	Chip select hold time (write)	15		ns	
	T <sub>CSS</sub>	Chip select setup time (read)	60		ns	
	T <sub>SCC</sub>	Chip select hold time (read)	65		ns	
	T <sub>CHW</sub>	Chip select "H" pulse width	40		ns	
SCL	T <sub>SCYCW</sub>	Serial clock cycle (Write)	66		ns	
	T <sub>SHW</sub>	SCL "H" pulse width (Write)	15		ns	
	T <sub>SLW</sub>	SCL "L" pulse width (Write)	15		ns	
	T <sub>SCYCR</sub>	Serial clock cycle (Read)	150		ns	
	T <sub>SHR</sub>	SCL "H" pulse width (Read)	60		ns	
	T <sub>SLR</sub>	SCL "L" pulse width (Read)	60		ns	
SDA (DIN)	T <sub>SDS</sub>	Data setup time	10		ns	
	T <sub>SDH</sub>	Data hold time	10		ns	
DOUT	T <sub>ACC</sub>	Access time	10	50	ns	For maximum CL=30pF
	T <sub>OH</sub>	Output disable time	15	50	ns	For minimum CL=8pF

Table 5 3-line serial Interface Characteristics

## Display Serial Interface Timing Characteristics (4-line SPI system)

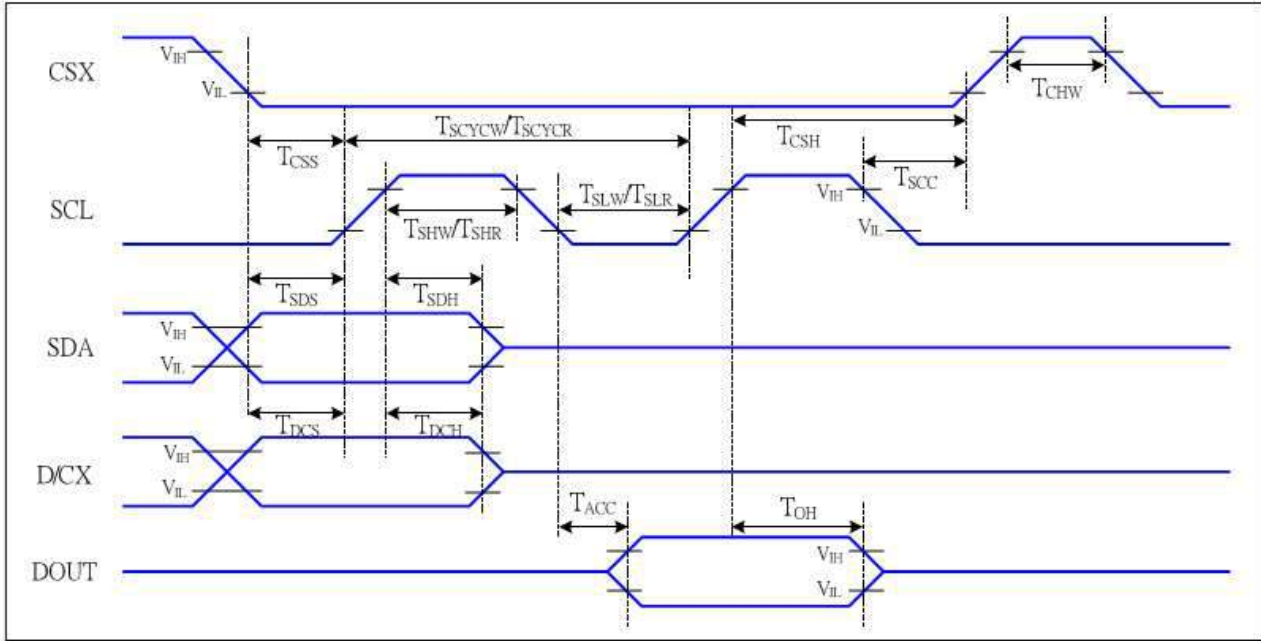

**Figure 5 4-line serial Interface Timing Characteristics**

VDDI=1.65 to 3.3V, VDD=2.4 to 3.3V, AGND=DGND=0V, Ta=-30 to 70 °C

Signal	Symbol	Parameter	MIN	MAX	Unit	Description
CSX	T <sub>CSS</sub>	Chip select setup time (write)	15		ns	
	T <sub>CSH</sub>	Chip select hold time (write)	15		ns	
	T <sub>CSS</sub>	Chip select setup time (read)	60		ns	
	T <sub>SCCR</sub>	Chip select hold time (read)	65		ns	
	T <sub>CHW</sub>	Chip select "H" pulse width	40		ns	
SCL	T <sub>SCYCW</sub>	Serial clock cycle (Write)	66		ns	-write command & data ram
	T <sub>SHW</sub>	SCL "H" pulse width (Write)	15		ns	
	T <sub>SLW</sub>	SCL "L" pulse width (Write)	15		ns	
	T <sub>SCYCR</sub>	Serial clock cycle (Read)	150		ns	-read command & data ram
	T <sub>SHR</sub>	SCL "H" pulse width (Read)	60		ns	
	T <sub>SLR</sub>	SCL "L" pulse width (Read)	60		ns	
D/CX	T <sub>DCS</sub>	D/CX setup time	10		ns	
	T <sub>DCH</sub>	D/CX hold time	10		ns	
SDA (DIN)	T <sub>SDS</sub>	Data setup time	10		ns	
	T <sub>SDH</sub>	Data hold time	10		ns	
DOUT	T <sub>ACC</sub>	Access time	10	50	ns	For maximum CL=30pF
	T <sub>OH</sub>	Output disable time	15	50	ns	For minimum CL=8pF

**Table 6 4-line serial Interface Characteristics**

### RGB Interface Characteristics:

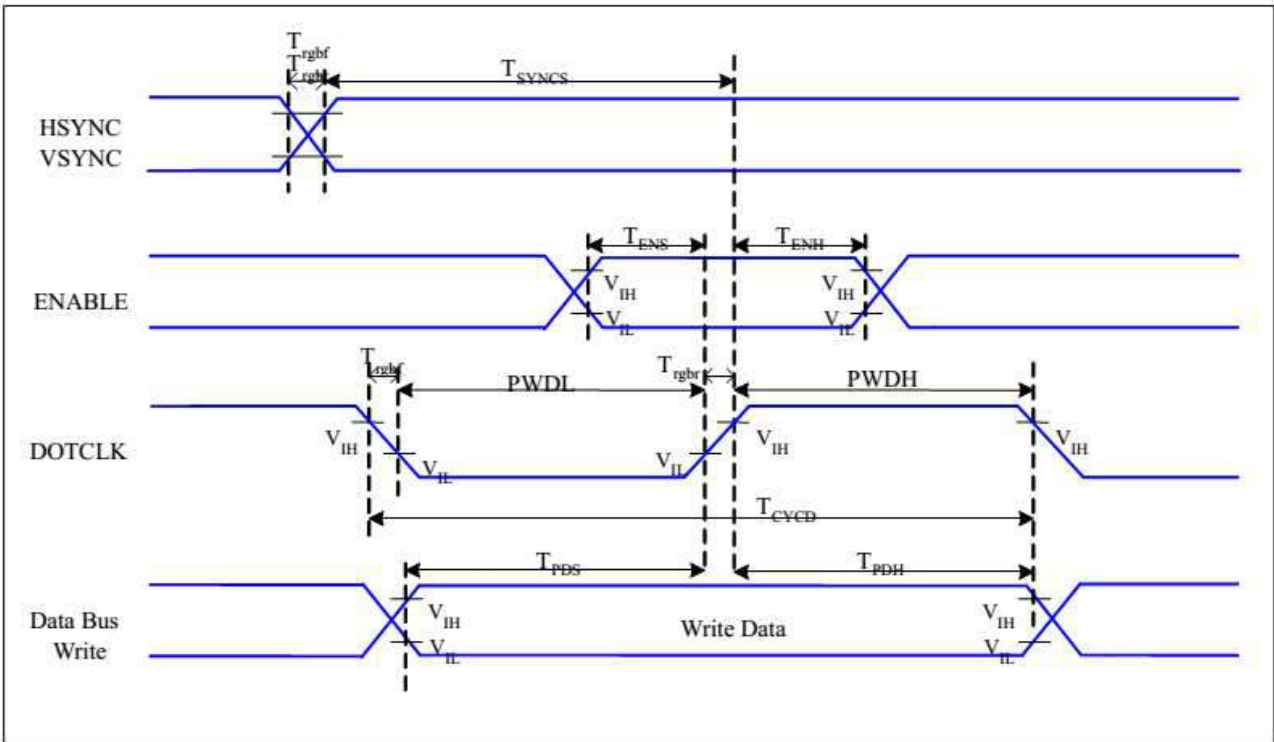

Figure 6 RGB Interface Timing Characteristics

VDDI=1.65 to 3.3V, VDD=2.4 to 3.3V, AGND=DGND=0V, Ta=-30 ~ 70 °C

Signal	Symbol	Parameter	MIN	MAX	Unit	Description
HSYNC, VSYNC	$T_{SYNCS}$	VSYNC, HSYNC Setup Time	30	-	ns	
ENABLE	$T_{ENS}$	Enable Setup Time	25	-	ns	
	$T_{ENH}$	Enable Hold Time	25	-	ns	
DOTCLK	PWDH	DOTCLK High-level Pulse Width	60	-	ns	
	PWDL	DOTCLK Low-level Pulse Width	60	-	ns	
	$T_{CYCD}$	DOTCLK Cycle Time	120	-	ns	
	$T_{rghr}, T_{rghf}$	DOTCLK Rise/Fall time	-	20	ns	
DB	$T_{PDS}$	PD Data Setup Time	50	-	ns	
	$T_{PDH}$	PD Data Hold Time	50	-	ns	

Table 7 18/16 Bits RGB Interface Timing Characteristics



# 9. POWER SEQUENCE

VDDI and VDD can be applied in any order.

VDD and VDDI can be power down in any order.

During power off, if LCD is in the Sleep Out mode, VDD and VDDI must be powered down minimum 120msec after RESX has been released.

During power off, if LCD is in the Sleep In mode, VDDI or VDD can be powered down minimum 0msec after RESX has been released.

CSX can be applied at any timing or can be permanently grounded. RESX has priority over CSX.

*Note 1: There will be no damage to the display module if the power sequences are not met.*

*Note 2: There will be no abnormal visible effects on the display panel during the Power On/Off Sequences.*

*Note 3: There will be no abnormal visible effects on the display between end of Power On Sequence and before receiving Sleep Out command. Also between receiving Sleep In command and Power Off Sequence.*

*Note 4: If RESX line is not held stable by host during Power On Sequence as defined in the sequence below, then it will be necessary to apply a Hardware Reset (RESX) after Host Power On Sequence is complete to ensure correct operation. Otherwise function is not guaranteed.*

The power on/off sequence is illustrated below

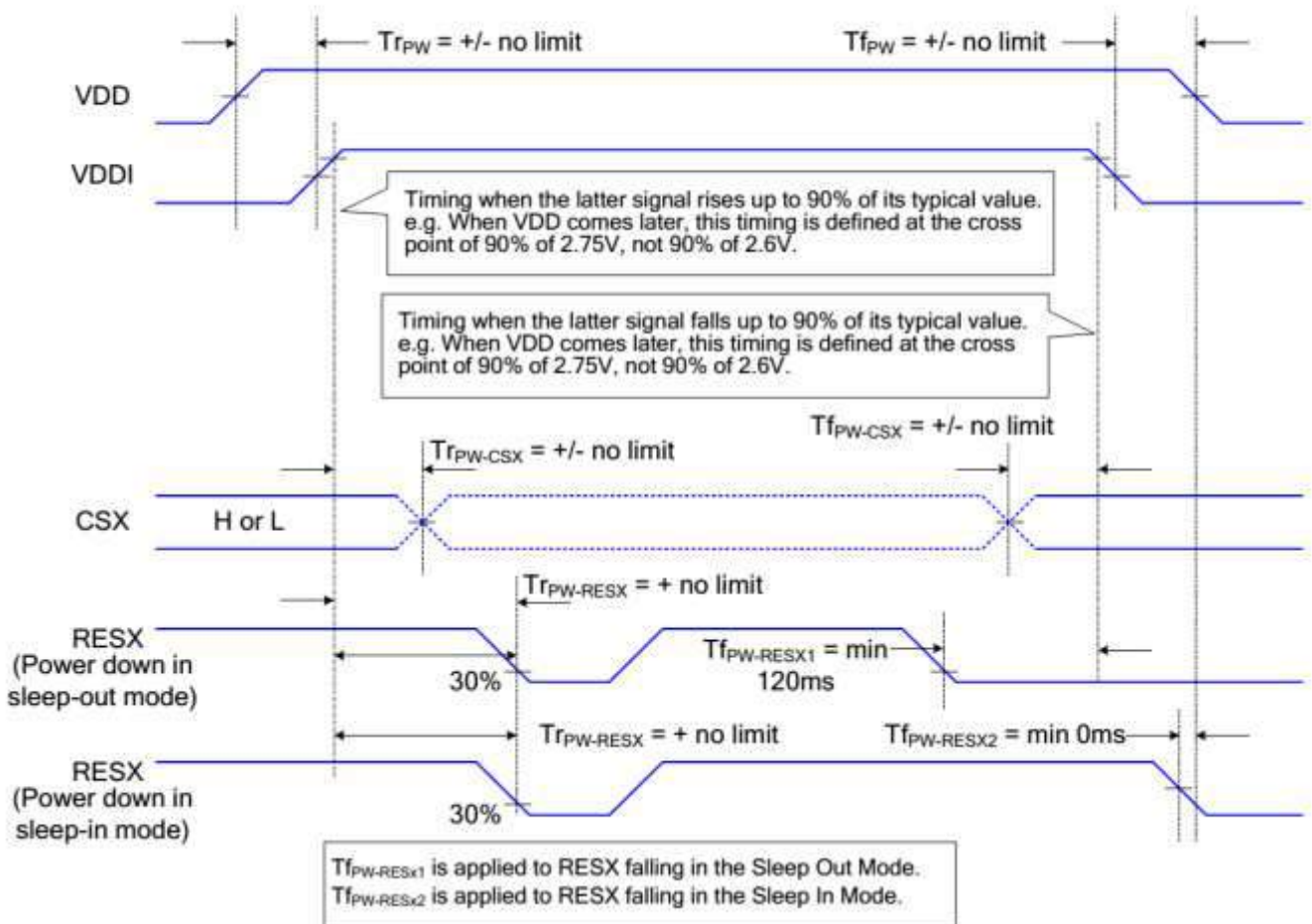

## 10. RELIABILITY TEST CONDITIONS

No.	Test item	Test condition	Inspection after test	
10.1	High temperature storage test	+80°C/240 hours	Inspection after 2~4hours storage at room temperature, the sample shall be free from defects : 1.Current changing value before test and after test is 50% larger; 2. Function defect : Non-display,abnormal-d isplay,missing lines, Short lines,I/O corrosion; 3.Visual defect : Air bubble in the LCD,Seal leak,Glass crack.	
10.2	Low temperature storage test	-30°C/240 hours		
10.3	High temperature operating test	+70°C/120 hours		
10.4	Low temperature operating test	-20°C/120 hours		
10.5	Temperature cycle storage test	-30°C ~ 25°C ~ +80°C/10cycles (30min.) (10min.) (30min.)		
10.6	High temperature high humidity test	+50°C*90% RH/120 hours		
10.7	Vibration test	Frequency : 250 r/min Amplitude : 1 inch Time: 45min		
10.8	Drop test	Drop direction: 1 corner/3 edges/6 sides 10 time		
		Packing weight(kg)		Drop height(cm)
		<11		80±1.6
		11≤G<21	60±1.2	
		21≤G<31	50±1.0	
		31≤G<40	40±0.8	
10.9	ESD test	Air discharge: ±8KV, 10time Contact discharge: ±4KV, 10time		
Remark : 1.The test samples should be applied to only one test item. 2.Sample size for each test item is 3~5pcs. 3.For High temperature high humidity test, Pure water(Resistance>10MΩ) should be used. 4.In case of malfunction defect caused by ESD damage, if it would be recovered to normal state after resetting, it would be judged as a good part. 5.B/L evaluation should be excepted from reliability test with humidity and temperature: Some defects such as black spot/blemish can happen by natural chemical reaction with humidity and Fluorescence B/L has. 6.Failure judgment criterion: Basic specification, Electrical characteristic, Mechanical characteristic, Optical characteristic.				



# 11.INSPECTION CRITERION

## 11.1. Objective

The TFT test criterion are set to formalize TFT quality standards for ODNA with reference to those of the customer for inspection, release and acceptance of finished TFT products in order to guarantee the quality of TFT products required by the customer.

## 11.2. Scope

The criterion is applicable to all the TFT products manufactured by ODNA.

## 11.3. Equipment for Inspection

Electrical tester, electrical testing machines, vernier calipers, microscopes, magnifiers, anti-static wrist straps, finger cots, labels, tri-phase cold and hot shock machine, constant temperature and humidity chamber, backlight table, ovens for high-low temperature experiments, refrigerators, constant voltage power supply (DC) ) , desk Lamps, etc.

## 11.4. Sampling Plan and Reference Standards

### 11.4.1.1 Sampling plan:

Refer to National Standard GB/T 2828.1---2012/ISO2859-1:1999, level II of normal levels:

Product Category	Consumer Electronics	Non-consumer Electronics	Industrial	Automobile	11.4.1.2 GB
AQL	MA=0.4 MI=1.5	MA=0.4 MI=1.0	MA=0.25 MI=0.65	MA=0.15 MI=0.40	

/T 2828.1---2012/ISO2859-1:1999 Sampling check procedure in count

11.4.1.3 GB/T 18910. Standard for LCM parts

11.4.1.4 GB/T24213-2008 Basic Environmental Test Procedures for Electrical and Electronic Products

11.4.1.5 IPC-A-610E Acceptability of Electronic Assemblies

## 11.5. Inspection Conditions and Inspection Reference

11.5.1 Cosmetic inspection: shall be done normally at  $23 \pm 5^{\circ}\text{C}$  of the ambient temperature and  $45\sim 75\%$  RH of relative humidity, under the ambient luminance between 500lux~1000lux and at the distance of 30cm apart between the inspector's eyes and the LCD panel and normally in reflected light. For backlight LCM, cosmetic inspection shall be done under the ambient luminance less than 100lux with the backlight on.

11.5.2 The TFT shall be tested at the angle of  $45^{\circ}$  left and right and  $0\sim 45^{\circ}$  top and bottom as the following picture showing:

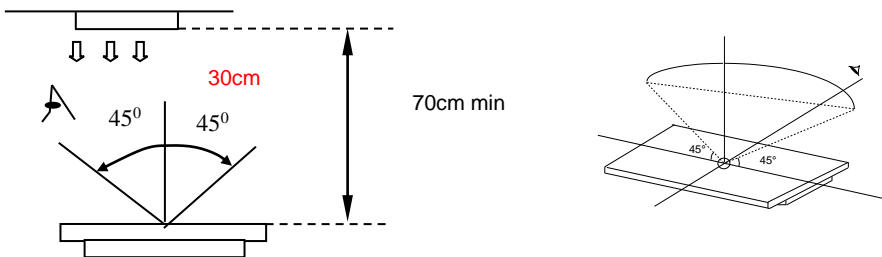

### 11.5.3 Definition of viewing area (VA)

A area: Active area (AA area)

B area: Viewing area (VA area)

C area: Non-viewing area (not viewing after customer assembly)

If there is any appearance viewing defect which do not affect product quality and customer assembly in C area, it's accepted in generally.

The criteria apply to A and B area except chipping and crack.

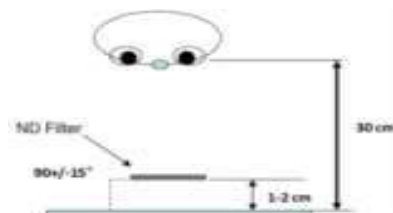
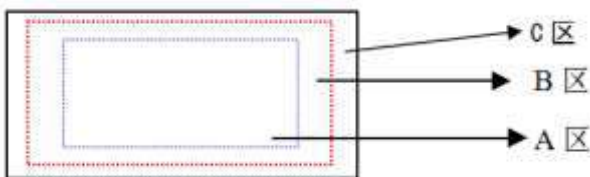

11.5.4 Inspection with naked eyes(exclusive of the inspection of the physical dimensions of defects carried out with magnifiers)

11.5.5 ND card use method(refer to right conner image ) and scope: Multi-bright dot; Mura(Black/Gray pattern uneven); dark line and so on.

11.5.6 Undefined items or other special items, refer to mutual agreement and limited sample. If criterion does not match product specifications/ technical requirement, both should be subject to special inspection criterion agreed by customer.







**11.6 Defects and Acceptance Standards**

11.6.1 Electrical properties test

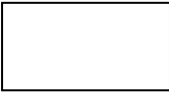
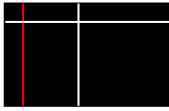
11.6.1.1 Test voltage(V): Refer to the instruction of testers and the product specification or drawing and the display content and parameters and display effects shall conform to the product specification and drawing.

11.6.1.2 Current Consumption(I): Refer to approved product specifications or drawings.

11.6.1.3 Function items(Defect category MA)

No.	Defects	Descriptions	Pictures	Inspection method/tools	Defect category
11.6.1.3.1	No display /reaction	shows no picture/display in normal connected situation.		Naked eyes/ testers	MA
11.6.1.3.2	Missing segment	Shows missing lines in normal display		Naked eyes/ testers	MA
11.6.1.3.3	Dark line	Only visible on gray pattern, 1 or more vertical/horizontal lines: 5%ND, not visible, OK	/	Naked eyes/ testers	MA
11.6.1.3.4	POL angle defect	Not accepted		Naked eyes/ testers	MA
11.6.1.3.5	Image retention (sticking)	Chess pattern stays for 30mins and change to 50% gray pattern, disappear in 10s, OK; if time>10s, NG		Naked eyes/ testers	MA
11.6.1.3.6	Flicker	Refer to Limit sample if essential or flicker value <-30dB (measured by CA310A); OK		Naked eyes/ CA310A	MA
11.6.1.3.7	Display abnormal	Not accepted		Naked eyes/ testers	MA
11.6.1.3.8	Cross-talk	Refer to limited sample		Naked eyes/ limited sample	MA
11.6.1.3.9	Display dim/bright	Refer to limited sample	/	Naked eyes/ limited sample	MA
11.6.1.3.10	Contrast	Refer to limited sample	/	Naked eyes/ limited sample	MA
11.6.1.3.11	Huge current	Out of spec, not accepted	/	Ammeter	MA
11.6.1.3.12	TP function defect	Not accepted	/	Naked eyes/ Touch/ test program	MA

11.6.2 LCD dot/line defect

11.6.2.1 LCD pixel dot defect(defect category: MI)

Item	Inspection criterion			
Size	S <5"	5≤S<10"	10≤S<15"	S≥15"

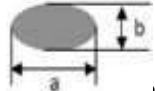
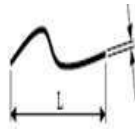
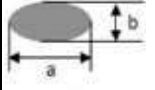

Item	Inspection criterion			
Color pixel dot defect(RGB dot)	1	2	2	3
2 connected bright dot	0	1	1	1
3 connected bright dot or more	0	0	1	0
Bright dot quantity	1	2	3	4
Random dark dot quantity	2	3	4	5
2 connected dark dot	1	1	2	2
3 connected dark dot or more	0	0	0	0
Dark dot quantity	3	4	5	6
Multi-bright dot	ND 5% hidden, OK			
Remark: 2 bright dots distance $DS \geq 15mm$ 2 dark dots distance $DS \geq 5mm$				
1) Bright dot: Power on TFT and RGB dot in black display				
2) Dark dot: Power on TFT and gray or black dot in RGB display				
3) Multi-bright dot: Power on TFT and fluorescent tiny dot in black display(only visible in black display)				

### 11.6.2.2 LCD appearance dot defect (defect category: MI)

No.	Item	Inspection criterion					Picture	Inspection method/tools	
		Size	S < 5"	5 ≤ S < 10"	10 ≤ S < 15"	S ≥ 15"			
11.6.2.2.1	Dot defect (black dot, white dot)	D ≤ 0.15	ignore	ignore	D ≤ 0.2; Not count	D ≤ 0.2; ignore		Naked eyes /film card /magnifier	
		0.15 < D ≤ 0.25	3	3					
		0.25 < D ≤ 0.30	1	2	0.2~0.35 Q'ty ≤ 4	0.2~0.35 Q'ty ≤ 5			
		0.30 < D ≤ 0.35	0	1					
		0.35 < D ≤ 0.50	0	0	1	2			
		D > 0.5	0	0	0	0			
Remark: D ≤ 0.15mm, not count. Multi-dot as bulk is not accepted. Count dot quantity ≤ 5; 2 round dots or linear dots in 1 cm is judged as multi-dot.									
11.6.2.2.2	Line defect (visible when power on)	Length (mm)	Width (mm)	S < 5"	5 ≤ S < 10"	10 ≤ S < 15"	S ≥ 15"		Naked eyes /film card /magnifier
		Not count	W ≤ 0.03	Ignored	Ignored	Ignored	Ignored		
		L ≤ 5	0.03 ≤ W < 0.05	3	3	Ignored	Ignored		
		L ≤ 5	0.05 ≤ W < 0.08	0	1	3	3		
		L ≤ 8	0.05 ≤ W < 0.08	0	0	1	2		
L > 8	W > 0.08	0	0	0	0				
Remark: Invisible when power on, only visible in special angle against light, show as watermark/folding/scratch but can not be touched, no control or refer to keeping sample.									
11.6.2.2.3	Polarizer convex-concave dot defect, polarizer bubble defect	Size(mm)	S < 5"	5 ≤ S < 10"	10 ≤ S < 15"	S ≥ 15"		Naked eyes /film card /magnifier	
		D ≤ 0.20	Ignored	Ignored	Ignored	Ignored			
		0.20 < D ≤ 0.5	2	2	3	5			
		0.50 < D ≤ 0.8	0	1	2	3			

	$0.8 < D \leq 1.5$	0	0	1	<u>2</u>
	$D > 1.5\text{mm}$	0	0	0	<u>0</u>

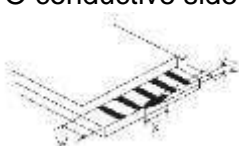
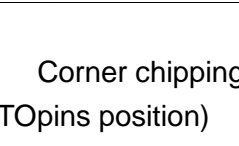
### 11.6.3 Chipping defect

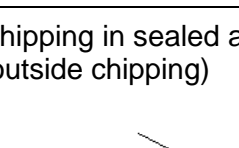
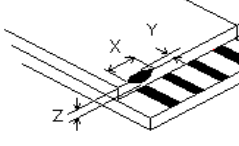
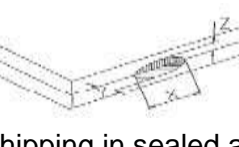
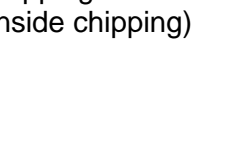
No.	Item	Accepted criterion(mm)				MAJ	MIN
11.6.3.1	ITO conductive side 	X	/	$\leq 1/8L$	/		√
		Y	$Y \leq 1/6W$	$1/6W < Y \leq 1/4W$	$1/4W < Y$		
		Accept	2	2	0		
11.6.3.2	Corner chipping (ITOpins position) 	X	/	$\leq 1/6L$	/		√
		Y	$Y \leq 1/2W$	$1/2W < Y \leq W$	$W < Y$		
		Accept	2	1	0		
		Corner chipping occurred in sealed edge position as per 6.3.3; at the same time it should not enter into black border of the frame and the corner chipping effect the electric connection position perform as per 6.3.1.					
11.6.3.3	Chipping in sealed area (outside chipping) 	X	/	$\leq 1/8L$	/		√
		Y (outside chipping)	Not enter into sealant	Enter $Y \leq H$	$H < Y$		
		Y (inside chipping)		Enter $Y \leq 1/2H$	$1/2H < Y$		
		Z	$\leq T$	$\leq 1/2T$	/		
		Accept	2	1	0		
Chipping in sealed area (inside chipping) 	The standards of inner and outer chipping on edge sealing area are same. When the chipping occurred in the opposite of stage, Y as per the chipping on the non-conduction side standard in 6.3.1						
11.6.3.4	conductive side (back side chipping) 	X	/	$\leq 1/6L$	/		√
		Y	$Y \leq 1/3W$	$1/3W < Y \leq 2/3W$	$2/3W < Y$		
		Accept	2	2	0		
		Chipping into ITO side ,refer to 6.3.1					
11.6.3.5	Protruding LCD poor cutting and LCD 	X	/	$\leq 1/8L$	/		√
		Y	$\leq 1/6W$	$1/6W$	$1/5W < Y$		

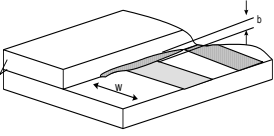
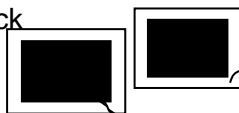
				$<Y \leq 1/5W$			
		Z	/	/	/		
		Accept	1	1	1		
		the outside protruding control as per the tolerance of drawing.					
11.6.3.6	Crack 	Not allow to occur cracks without direction; the crack expand to inside is NG, but to outside is OK (confirmed as per the damaged standard)					√
Remark:1)X means the length of chipping; Y means the width; Z means the thickness; W means the step width of the two glasses; H means the distance from the glass edge to the seal inner edge; t means glass thickness.							

#### 11.6.4 Backlight components

No.	Item	Description	Accepted criterion	MAJ	MIN
11.6.4.1	No backlight wrong Color	/	Rejected	√	
11.6.4.2	Color deviation	When powered on, the LCD color differs from its sample and found that the color not conforming to the drawing after testing.	Refer to sample and drawing.		√
11.6.4.3	Brightness deviation	When powered on, the LCD brightness differs from its sample and is found after testing not conforming to the drawing; or if it conforms to the drawing but the brightness over $\pm 40\%$ than its typical value.	Refer to sample and drawing.		√
11.6.4.4	Uneven brightness	Uneven on the same LCD and out of the specification of the drawing. The no specification evenness= (the max value-the min value)/ mean value $< 70\%$ .	Refer to sample and drawing.		√
11.6.4.5	Spot/line /scratch	When power on, it has dirty spot, scratches and so on spot and line defects.	Refer to 6.2.2		√

#### 11.6.5 Metal frame (Metal Bezel)

No.	Item	Description	Accepted criterion	MAJ	MIN
11.6.5.1	Material & surface treatment	Metal frame/surface treatment do not conform to the specifications.	Rejected	√	
11.6.5.2	Tab twist Unconformity/ Tab not twisted	Wrong twist method or direction and twist tabs are not twisted as required.	Rejected	√	
11.6.5.3	Bezel paint loss	1.Front surface: Paint peel off and scratch to the bottom	Rejected		√
11.6.5.4	Bezel scratch	Dot:D $\leq 0.5$ mm, exceeds 3; Line:L $\leq 3.0$ mm,W $\leq 0.05$ mm			√
11.6.5.5	Painting peel off, discoloration,	exceeds 2; 2.Front dent, air bubble and side			√

	dent, and scratch	with paint peeling off scratch to the bottom Dot: $D \leq 1.0\text{mm}$ , exceeds 3; Line: $L \leq 10.0\text{mm}$ , $W \leq 0.05\text{mm}$ , exceeds 2;			
11.6.5.6	Burr	Burr(s) on metal bezel is so long as to get into viewing area.	Rejected		√

#### 11.6.6 FPC



No.	Item	Description	Accepted criterion	MAJ	MIN
11.6.6.1	Model & P/N	Material model & P/N	Keep the same with drawing and technical requirement	√	
11.6.6.2	Dimension/ position	Dimension in drawing spec  Remark: H=ITO pin length f=FPC width W=ITO pin width	$f \leq 1/3w$ , $h \leq 1/3H$ , dimension in drawing spec-> OK Conductive material and ITO/PDA connective area must over than 1/2. Entire dimension must be in spec tolerance.		√
11.6.6.3	FPC appearance	Hot pressing material get broken, folding line open; FPC golden finger oxidate, broken ,scratch ,foreign material which cause line short	Broken length < 2mm; FPC line is OK -> Accepted Crack and line broken-> Rejected		√
11.6.6.4	FPC burr	Burr near FPC edge area	When cover line and burr length $\leq 1.0\text{mm}$ ->Accepted		√
11.6.6.5	FPC falling off	FPC bonding area falling off ; silica gel breaking	Rejected		√
11.6.6.6	Sealant missing ITO line	Sealant is not covered all ITO line	Rejected	√	
11.6.6.7	Missing sealant	No sealant	Rejected	√	
11.6.6.8	Sealant	Sealant height > product total height	Rejected	√	

#### 11.6.7 SMT

No.	Item	Description	Accepted criterion	MAJ	MIN
11.6.7.1	Soldering bridge	Solder between adjacent pads and components 	Rejected		√
11.6.7.2	Solder ball/splash	Solder ball/tin dross causing short circuit at the solder point. There are active solder ball and splash.	Rejected		√
11.6.7.3	Soldering excursion	Soldering slant > 1/3 soldering pad 	Rejected		√

11.6.7.4	Component wrong attaching	Component on PCB differs with drawing: wrong one, extra one, lack one, opposite polarity	Rejected	√	
		JUMP short circuit on PCB: extra soldering ,lack soldering.	Rejected	√	
11.6.7.5	Component falling off	Soldering but component is missing	Rejected	√	
11.6.7.6	Wrong component	Component model/spec differs from product specification	Rejected	√	

#### 11.6.8 General Appearance

No.	Item	Description	Accepted criterion	MAJ	MIN
11.6.8.1	Dimension	According to drawing	Accepted	√	
11.6.8.2	Surface stain	Defect mark or label are not removed residual glue, and finger print,etc;	Rejected		√
11.6.8.3	Assembly foreign material	Dot/linear stain after assembly backlight and diffuse film TP assembly foggy stain	Invisible when power on->OK Refer to 6.2.2 dot/line spec		√
11.6.8.4	Mixture	Different model product in the same shipment	Rejected	√	
11.6.8.5	Product mark	Missing, unclear, incorrect, or misplaced part	Rejected		√
11.6.8.6	Component mark	Silk screen mark clear, resistance measured value in spec	Accepted (Refer to customer special requirement)		√
11.6.8.7	Newton's rings	Area<1/6 screen area quantity≤1	Accepted		√
11.6.8.8	Mura	1.In black display ND 5% invisible ->OK; visible->NG 2.Naked eyes inspection RGB display invisible Black display, area<1/4 screen area	Refer to limited sample 		√
11.6.8.9	Light leak	1.LCD edge(near backlight) shadow by LCD lamps irregular illuminate 2.Judge in black/white/gray display (slight leaky is yellowish, greenish, bluefish ->NG) ;	Refer to limited sample 		√
11.6.8.10	Polarizer	1.Polarizer slant.Cover VA and not over LCD edge 2.No unmovable stain or finger print in polarizer VA 3.Bubble/warped but not enter VA	Accepted		√
11.6.8.11	TP defect	1.TP crack 2.TP stain(foggy&unremovable) 3.TP glue overflow to VA	Rejected		√

Remark: Anything which is not clearly defined in 6.5~6.8 should refer to IPC-A-610E.Consumer Electronics, Non-consumer Electronics refer to class 1 and Industrial, Automobile refer to Class 2.

## 11.7. Others

Items not specified in this document or released on compromise should be inspected with reference to mutual agreement and limit samples.

## 12. HANDLING PRECAUTIONS

### 12.1 Mounting method

The LCD module consists of two thin glass plates with polarizers which easily be damaged. And since the module is so constructed as to be fixed by utilizing fitting holes in the printed circuit board.

Extreme care should be needed when handling the LCD modules.

### 12.2 Caution of LCD handling and cleaning

When cleaning the display surface, Use soft cloth with solvent [recommended below] and wipe lightly :

- .Isopropyl alcohol
- .Ethyl alcohol

Do not wipe the display surface with dry or hard materials that will damage the polarizer surface.

Do not use the following solvent :

- .Water
- .Aromatics

Do not wipe ITO pad area with the dry or hard materials that will damage the ITO patterns

Do not use the following solvent on the pad or prevent it from being contaminated :

- .Soldering flux
- .Chlorine (Cl) , Sulfur (S)

If goods were sent without being silicon coated on the pad, ITO patterns could be damaged due to the corrosion as time goes on.

If ITO corrosion happens by miss-handling or using some materials such as Chlorine (Cl), Sulfur (S) from customer, Responsibility is on customer.

### 12.3 Caution against static charge

The LCD module uses C-MOS LSI drivers, so we recommend that you :

Connect any unused input terminal to Vdd or Vss, do not input any signals before power is turned on, and ground your body, work/assembly areas, assembly equipment to protect against static electricity.

### 12.4 Packing

Module employs LCD elements and must be treated as such.

- .Avoid intense shock and falls from a height.
- .To prevent modules from degradation, do not operate or store them exposed direct to sunshine or high temperature/humidity.

### 12.5 Caution for operation

- .It is an indispensable condition to drive LCD's within the specified voltage limit since the higher voltage than the limit causes the shorter LCD life.
- .An electrochemical reaction due to direct current causes LCD's undesirable deterioration, so that the use of direct current drive should be avoided.
- .Response time will be extremely delayed at lower temperature than the operating temperature range and on the other hand at higher temperature LCD's show dark color in them. However those phenomena do not mean malfunction or out of order with LCD's, which will come back in the specified operation temperature.
- .If the display area is pushed hard during operation, some font will be abnormally displayed but it resumes normal condition after turning off once.
- .A slight dew depositing on terminals is a cause for electro-chemical reaction resulting in terminal open circuit.
- .Usage under the maximum operating temperature, 50%Rh or less is required.
- .When fixed patterns are displayed for a long time, remnant image is likely to occur.

### 12.6 Storage

In the case of storing for a long period of time for instance, for years for the purpose or replacement use, the following ways are recommended.

- .Storing in an ambient temperature 10°C to 30°C, and in a relative humidity of 45% to 75%. Don't expose to sunlight or fluorescent light.
- .Storing in a polyethylene bag with the opening sealed so as not to enter fresh air outside in it . And with no desiccant.
- .Placing in a dark place where neither exposure to direct sunlight nor light's keeping the storage temperature range.
- .Storing with no touch on polarizer surface by anything else.

It is recommended to store them as they have been contained in the inner container at the time of delivery from us.



### **12.7 Safety**

- .It is recommendable to crash damaged or unnecessary LCD's into pieces and wash off liquid crystal by either of solvents such as acetone and ethanol, which should be burned up later.
- .When any liquid leaked out of a damaged glass cell comes in contact with your hands, please wash it off well with soap and water.

### **13. PRECAUTION FOR USE**

**13.1** A limit sample should be provided by the both parties on an occasion when the both parties agreed its necessity. Judgment by a limit sample shall take effect after the limit sample has been established and confirmed by the both parties.

**13.2** On the following occasions, the handing of problem should be decided through discussion and agreement between responsible of the both parties.

- .When a question is arisen in this specification.
- .When a new problem is arisen which is not specified in this specifications.
- .When an inspection specifications change or operating condition change in customer is reported to ODNA, and some problem is arisen in this specification due to the change.
- .When a new problem is arisen at the customer's operating set for sample evaluation in the customer site.

### **14. PACKING SPECIFICATION**

Please consult our technical department for detail information.

### **15. INITIALIZATION CODE**

```

WriteComm(0x11);
Delay(120); //Delay 120ms
//-----Display Setting-----//
WriteComm(0x36);
WriteData(0x80);
WriteComm(0x3a);
WriteData(0x05);
WriteComm(0x21);
WriteComm(0x2a);
WriteData(0x00);
WriteData(0x00);
WriteData(0x00);
WriteData(0xef);
WriteComm(0x2b);
WriteData(0x00);
WriteData(0x00);
WriteData(0x00);
WriteData(0xef);
//-----ST7789V Frame rate setting-----//
WriteComm(0xb2);
WriteData(0x0c);
WriteData(0x0c);
WriteData(0x00);
WriteData(0x33);
WriteData(0x33);
WriteComm(0xb7);
WriteData(0x35);
//-----ST7789V Power setting-----//
WriteComm(0xbb);
WriteData(0x18); //1F
WriteComm(0xc0);
WriteData(0x2c);
WriteComm(0xc2);
WriteData(0x01);
WriteComm(0xc3);
WriteData(0x20);// 12
WriteComm(0xc4);
WriteData(0x20);
WriteComm(0xc6);
WriteData(0x0f);
WriteComm(0xd0);
WriteData(0xa4);
WriteData(0xa1);
//-----ST7789V gamma setting-----//
WriteComm(0xe0);
WriteData(0xd0);
WriteData(0x08);
WriteData(0x11);
WriteData(0x08);
WriteData(0x0c);
WriteData(0x15);
WriteData(0x39);
WriteData(0x33);
WriteData(0x50);
WriteData(0x36);
WriteData(0x13);
WriteData(0x14);
WriteData(0x29);
WriteData(0x2d);

WriteComm(0xe1);
WriteData(0xd0);
WriteData(0x08);
WriteData(0x10);

```

**WriteData(0x08);**  
**WriteData(0x06);**  
**WriteData(0x06);**  
**WriteData(0x39);**  
**WriteData(0x44);**  
**WriteData(0x51);**  
**WriteData(0x0b);**  
**WriteData(0x16);**  
**WriteData(0x14);**  
**WriteData(0x2f);**  
**WriteData(0x31);**

WriteComm(0x29);

## **16. HSF COMPLIANCE**

•.This products complies with ROHS 2011/65/EU and 2015/863/EU、REACH 1907/2006/EC requirements, and the packaging complies with 94-62-EC.