

DESCRIPTION

Demonstration circuit DC465 is configured to easily interface the LTC[®]1955 dual smart card interface to a personal computer via an RS232 serial port. The demonstration package includes a compact disk containing a user-friendly graphical interface program. RS232 commands are interpreted by the MC68HC711E9CFN2 microcontroller and sent on to the LTC1955. A simple interface language

(ICCICL) is permanently programmed into the microcontroller and is summarized in Appendix A. The demonstration circuit operates on a 3V to 5.5V input supply. To begin evaluating the LTC1955 using demo circuit DC465 see Getting Started in the Quick Start Guide section.

 LTC and LT are registered trademarks of Linear Technology Corporation.

PERFORMANCE SUMMARY

PARAMETER	CONDITIONS	VALUE
V_{BATT} Input Voltage Range		2.7V to 5.5V
V_{BATT} Supply Current	$V_{BATT} = 3.6V$, $I_{CCA} = I_{CCB} = 0mA$, $V_{CCA} = V_{CCB} = 5V$	390 μ A
V_{BATT} Shutdown Current	$V_{BATT} = 3.6V$, $V_{CPO} = 0V$	1 μ A
DV_{CC} Input Voltage Range		3V to 5.5V
DV_{CC} Supply Current	$DV_{CC} = 3.6V$, Serial Port Unconnected	5mA

TYPICAL PERFORMANCE CHARACTERISTICS AND BOARD PHOTO

Deactivation Sequence

DC465 with Two Smart Cards

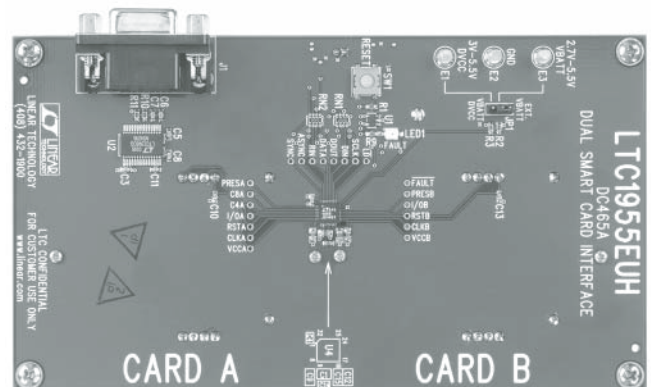

DEMO MANUAL DC465

RS232 DUAL SMART CARD INTERFACE

PACKAGE AND SCHEMATIC DIAGRAM

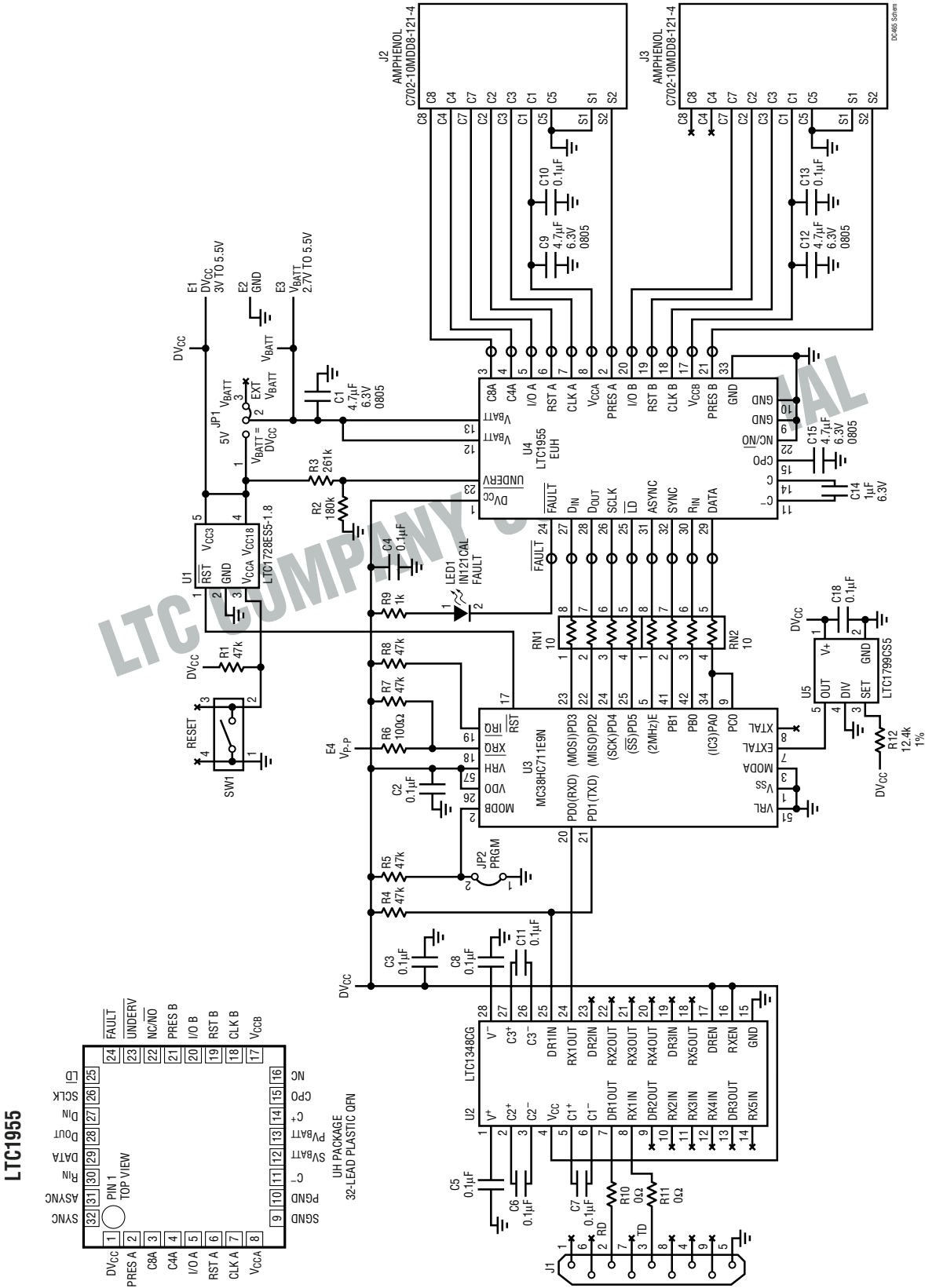

Figure 1

DEMO MANUAL DC465

RS232 DUAL SMART CARD INTERFACE

PARTS LIST

REFERENCE	QUANTITY	PART NUMBER	DESCRIPTION	VENDOR	TELEPHONE
C1, C15	2	JMK212BJ475MG	4.7 μ F 6.3V X5R Capacitor	Taiyo Yuden	(408) 573-4150
C2-C8, C10, C11, C13, C16	11	0603YC104MAT1A	0.1 μ F 16V C7R Capacitor	AVX	(843) 946-0362
C9, C12, C14	3	JMK107BJ105MA	1 μ F 6.3V X5R Capacitor	Taiyo Yuden	(408) 573-4150
E1, E2, E3	3	2501-2	0.094" Turret Testpoint	Mill-Max	(516) 922-6000
E4	1	2308-2	0.064" Turret Testpoint	Mill-Max	(516) 922-6000
JP1	1	2802S-03-G1	0.079cc 3-Pin 1-Row JMP	Comm-Con	(626) 301-4200
JP2	1	2802S-02-G1	0.079cc 2-Pin 1-Row JMP	Comm-Con	(626) 301-4200
Shunts for JP1, JP2	2	CC1J2MM-138G	0.079" Center Shunt	Comm-Con	(626) 301-4200
J1	1	DR-E9SB-NJ000-S0007	DB9F R-Angle Conn CON-DB9R	Signatron	(909) 464-1883
J2, J3	2	C702-10M008-121-4	10P Smart Card Connector	Amphenol	
LED1	1	LN1261CAL-(TR)	Bright Red LED	Panasonic	(201) 348-5217
RN1, RN2	2	CRN16-4V-100JAM	10 Ω Res 2x4 Array ISO Chip	AAC	(714) 255-9186
R1, R4, R5, R7, R8	5	CR16-473JM	47k 1/16W 5% Chip Resistor	AAC	(800) 508-1521
R2	1	CR16-184JM	180k 1/16W 5% Chip Resistor	AAC	(800) 508-1521
R3	1	CR16-244JM	240k 1/16W 5% Chip Resistor	AAC	(800) 508-1521
R6	1	CR16-101JM	100 Ω 1/16W 5% Chip Resistor	AAC	(800) 508-1521
R9	1	CR16-102JM	1k 1/16W 5% Chip Resistor	AAC	(800) 508-1521
R10, R11	2	CJ06-000M	0 Ω 1/16W 5% Chip Resistor	AAC	(800) 508-1521
R12	1	CR16-1242FM	12.4k 1/16W 1% Chip Resistor	AAC	(800) 508-1521
SW1	1	EVQ-QWS02W	Micropushbutton Switch	Panasonic	(201) 392-4511
U1	1	LTC1728ES5-1.8	IC SOT-23-5	LTC	
U2	1	LTC1348CG	IC SSOP-28G	LTC	
U3	1	MC68HC711E9CFN2	IC PLCC-52	Motorola	(800) 441-2447
U4	1	LTC1955EUH	IC 5x5 QFN-32	LTC	
U5	1	LTC1799CS5	IC SOT-23-5	LTC	
For MTGS at 4 Corners	4		#4-40 1/4" Screw	Any	
For MTGS at 4 Corners	4	14HTSP003	#4-40 1/2" Nylon Hex Standoff	Micro Plastics	(870) 453-8861

Notes: Unless otherwise specified

Note 1: All resistors are in ohms.

Note 2: Install shunts on JP1 Pin 1 and 2, JP2 Pin 2 and 3.

Note 3: Install four standoff components on bottom side.

QUICK START GUIDE

SYSTEM REQUIREMENTS

- PC with a 486 processor or higher and serial port mapped to COM1
- Microsoft Windows 95 or higher
- CD-ROM drive
- PC keyboard
- 9-pin male-female serial cable (straight through connection)
- A bench power supply or battery pack capable of producing 3V to 5.5V at up to 250mA of current.

GETTING STARTED

The software must be installed on a personal computer before the demonstration board can be evaluated. Follow the software installation instructions below.

Software Installation

- Insert the compact disk labeled LTC1955 into an appropriate CD-ROM drive on the PC.
- Access the CD-ROM drive, double click the link **SETUPRT.BAT** and follow the instructions until the HP VEE RUNTIME libraries are installed.
- Access the CD-ROM drive, double click the link **SETUPIO.BAT** and follow the instructions until the HP VEE IO libraries are installed.
- From the Start Menu of the personal computer select “Run...”. At the “Open:” prompt type: “veerun -ioconfig” and click the [OK] button.

When the dialog box appears, click the [Add Instrument...] button.

Ensure that the settings are:

Name: SERIAL1955

Interface: Serial

Address (eg 9) 1

Click on “Advanced IO Config...”

On the **General** tab change the settings to:

Timeout (sec) 0.1

Live Mode: ON

Byte Ordering MSB

On the Serial tab ensure that the settings are:

Baud Rate: 9600

Character Size: 8

Stop Bits: 1

Parity: None

Handshake: None

Receive Buffer Size: 4096

Click [OK]

Click [OK]

Click [SAVE CONFIG]

Hardware Connections

- Connect the 9 pin male-female serial cable from the PC serial port (COM1) to the demonstration board.
- Ensure that Jumper JP1 is in its $V_{BATT} = DV_{CC}$ position (connecting terminals E1 and E3).
- Apply 3.2V to 5.5V from “ V_{BATT} ” to “GND.”

Running the Program

- Access the CD-ROM drive and double click the program icon **LTC1955.vxe**. The demonstration program will appear on the screen. (See Figure 2.)
- Insert a credit card or smart card into smart card socket A. On the computer screen, the icon for smart card socket A should indicate the presence of a card.
- Using the software program, move the voltage slider for card A to the 3V position. Measure V_{CCA} with respect to GND on the demonstration board and observe that it is at approximately 3V.

QUICK START GUIDE



Figure 2

OPERATION

The graphical interface program, LTC1955.vxe, can be used to perform extensive evaluation of the LTC1955. It can be used to set the voltage on both card channels to 1.8V, 3V or 5V as well as the clock divider modes for both channels. By using the SELECT, DATA and RIN controls it can manipulate the I/O and RST pins of both smart card sockets. If an EMV compliant asynchronous smart card is inserted into one of the sockets, its answer to reset can be retrieved. Finally, it provides status indicators showing the state of each smart card channel. There are indicator icons for card detection, V_{CC} status, electrical fault status and ATR fault status. The program can be iterated in an infinite loop or it can be switched to single-step mode.

Looping vs Single-Stepping the Program

As mentioned above, the graphical interface program can be looped continuously or operated in single-step mode. For the following sections, the program should be left in LOOP mode unless otherwise noted (it will automatically start in this mode). The LOOP-STEP slider in the lower right corner of the program window controls the mode of the program. If the slider is switched to STEP mode then only a single read/write cycle to the LTC1955 is performed with each press of STEP/CONTINUE.

LOOP mode is indicated by the clockwise arrow to the left of the LOOP-STEP control slider. When in STEP mode, a pulse icon appears in this location.

Smart Card Detection

The smart card detection channels will indicate the presence of a card by changing the smart card icons in the program window. When no card is present, the icon will show "NO CARD." When a card is present it will show "CARD PRESENT."

Hint: It is important to have a card in the socket for the following sections. Setting a card voltage (other than 0V) on an empty card socket will result in an automatic card removal fault. Any standard credit card or even a reversed smart card can be used to activate the card detection switches.

Setting V_{CCA} and V_{CCB}

The V_{CC} settings of both channels can be set quickly by using the voltage sliders to the right of the smart card icons. Simply manipulate one of the sliders from 0V to 1.8V, 3.0V or 5.0V. Use a voltmeter to confirm that the V_{CCA}/V_{CCB} voltage at the smart card socket is correct.

Note: It is possible to change the slider from any setting to any other setting using the software. However, if the slider is moved from a lower voltage setting, (other than 0V) to a higher voltage setting, a fault on that channel will likely result. This is due to both an undervoltage and overcurrent condition on that channel. All settings should start from the 0V position. If a fault does occur, it can only be cleared by returning the slider to the 0V position. Changing from a higher voltage setting to a lower voltage setting will generally not result in a fault.

Setting the LTC1955 Clock Modes

Once a smart card socket is activated at one of the three V_{CC} levels its clock speed can be easily changed. Using an oscilloscope, observe the CLK A/CLK B pin of a given channel. With the clock setting slider set to CLK ÷ 1 mode, observe that the CLK A/CLK B pin is switching at precisely 2MHz. By moving the slider to CLK ÷ 2, CLK ÷ 4 and CLK ÷ 8 the clock frequency can be changed to 1MHz, 500kHz and 250kHz respectively. By moving the control slider to Stop Low or Stop High the CLK A/CLK B pins can be stopped in either state.

Setting RST A and RST B

The RST pins of both channels can be manipulated by first selecting a channel and then setting or clearing RIN. On the right side of the main program window set the center slider switch to either SELECT A or SELECT B. Above the selection switch manipulate the RIN slide control to HI. Observe with a voltmeter that the RST pin for the selected channel has gone to its V_{CC} level. Sliding the RIN control back to LO will force the RST pin back to 0V. The other channel can be manipulated similarly.

The RST latches on the LTC1955 can be demonstrated using these controls. Once a channel is selected, its RST pin follows the RIN slide control. If the other channel is

OPERATION

selected or neither channel is selected the RST pin will ignore changes on this control and will remain in its current state.

Asserting I/O A and I/O B

The I/O pins of both channels can also be easily manipulated. First a channel must be selected using the select switch at the center-right of the main program window. Once a channel is selected, its I/O pin will follow the state of the DATA slider control. Note that the I/O pin for an unselected channel will automatically return to the Z state (high).

Detecting Card Removal Faults

Once a channel has been powered to 1.8V, 3V or 5V it will indicate a card removal fault upon extraction of the card. This can be demonstrated by powering up either channel and simply removing the card. The fault will be cleared when the voltage slider is moved back to 0V. Note that a card removal fault is considered an electrical fault. It can be distinguished from other faults such as short circuits by observing both the fault status bit and the card detection bit in the LTC1955's status word.

Detecting ATR Faults

The LTC1955 has an answer to reset counter to detect ATR faults. An ATR fault can be detected by selecting an energized channel and setting the RIN slider to HI. Notice that without a real smart card in the socket the ATR STATUS indicator for that channel switches to red. The fault will be cleared in the LTC1955 by switching RIN back to LO.

Detecting Electrical Faults

Electrical faults can be demonstrated in a number of ways. Once a channel's V_{CC} is brought to 1.8V, 3V or 5V it can be shorted to GND. Furthermore, short circuits on the CLK and RST pins will result in an electrical fault. They can be induced by shorting the CLK or RST pins to the supply representing its opposite state ($V_{CCA/B}$ or GND) or by shorting to the same potential and changing the state of the pin using the software.

Retrieving an Answer to Reset

The demonstration board DC465 has the capability of retrieving the answer to reset from an asynchronous card. This is accomplished by the following steps:

1. Insert an asynchronous EMV or ISO7816 compliant smart card in either socket
2. Set the voltage slider to the appropriate level for the card
3. Select the smart card using the SELECT slider
4. Ensure that the clock slider is set to CLK ÷ 1
5. Move the LOOP-STEP slider to the STEP position
6. Move the GET ATR slider to the ON position
7. Push the STEP/CONTINUE button

The answer to reset will appear in the output box at the bottom left of the program window.

Separating V_{BATT} and DV_{CC}

For maximum flexibility the LTC1955 has two separate supply levels. V_{BATT} provides the main power to the chip and DV_{CC} is used as a reference level for the digital control inputs and outputs. On demonstration board DC465, DV_{CC} provides power to the microcontroller as well as the LTC1348 RS232 chip. While the LTC1955 will work with DV_{CC} levels as low as 1.6V these two chips need at least 3V to operate correctly.

Jumper JP1 connects DV_{CC} and V_{BATT} . To experiment with various V_{BATT} levels simply remove the shorting bar from JP1 and apply a separate supply to V_{BATT} . V_{BATT} is specified down to 2.7V but will typically work below that level if the LTC1955 is not asked to deliver significant power. The undervoltage detection set point has been set to approximately 2.93V and is detecting the DV_{CC} line.

Advanced Evaluation Using ICCICL

The onboard microcontroller contains a very simple LTC1955 control language known as ICCICL that can be used to access the LTC1955 directly. ICCICL (interface chip card interface command language) can be accessed by a simple dumb terminal or with a personal computer. With a personal computer, either a terminal emulation program could be used or a dedicated program could be

dc465f

DEMO MANUAL DC465

RS232 DUAL SMART CARD INTERFACE

OPERATION

written in a high level language such as BASIC to send commands to the LTC1955. The demonstration disk contains a shareware terminal emulation program known as Zebra103.

The RS232 port of the demonstration board is configured for 9600 8-N-1.

The ICCICL command structure is documented in Appendix A. The commands consist of a single character. Some commands will be followed by an argument of either 2 or 4 hexadecimal characters.

The simplest command is the question mark - ?. This command doesn't affect the LTC1955 but can be used to determine if the demonstration board is working properly and connected to the correct port of the personal computer. If all connections and settings are correct the demonstration board will return the string "ICCICL" in response to the ? command. No carriage or line feed will be returned and the ? will not be returned. The cursor will simply remain at the end of the ICCICL string.

The most commonly used command will be the serial port command (minus sign) -. The serial port command always needs to be followed by 4 hexadecimal characters. These characters are translated into binary and sent directly to the LTC1955's command register. For example, to configure the LTC1955 for $V_{CCA} = 3V$, card A selected, I/O A connected to DATA and CLK A set to ASYNC ÷ 2 the ICCICL command would be:

-BE00

To clear both ports of the LTC1955 the command would be:

-0000

Note: The command will not be echoed to the screen.

Upon entry of a serial port command, the LTC1955 status word will be immediately sent to the screen. For example if there is a card inserted into each socket and the command -0000 is given, the screen will show the following:

-00008080

8080 shows that bits D15 and D7 are both 1. These bits indicate the presence of the smart cards. Recall that the -0000 will not appear as it will not be echoed. Further-

more, as serial port commands are entered, the resulting status data will appear on the screen without a carriage return or linefeed.

As mentioned above, more sophisticated programs can be used to write command data and receive status data from the demonstration board using ICCICL. The program will need to be able to communicate with the correct serial port on the personal computer.

Using a Different Microcontroller

To experiment with different microcontrollers a separate board containing the microcontroller will be needed. It can be connected to DC465 by a ribbon cable or individual fly wires. The onboard microcontroller can be disconnected from the LTC1955 by removing resistor networks RN1 and RN2 from the demonstration board. This can be accomplished by either carefully clipping their pins or by melting their solder and carefully lifting them up. Their solder can be melted by locally heating the board with a temperature controlled heat gun set to approximately 600°F (351°C).

Troubleshooting

The most likely problem with DC465 will be getting proper communications with a host personal computer. Problems can arise from selecting the wrong port or having the wrong protocol settings for the correct port. Note that on most Windows based systems the physical serial port is mapped to a logical port. For the LTC1955 graphical user interface the port is COM1.

It is possible that the RS232 port of the computer is connected for null modem. In this configuration the output of the LTC1348 RS232 chip may be connected to the output of the serial port and likewise the inputs may be connected together. No damage will occur if the board is connected but of course it will not function properly. The simplest solution to this problem is to insert a null modem adapter in series with the serial cable. These adapters simply switch the TD and RD signals from the computer. Alternatively DC465 is configured with series resistors R10 and R11 that can be removed. Once they are carefully removed, two small jumper wires can be tack soldered to their pads to convert the board to the null modem configuration.

OPERATION

APPENDIX A THE ICCICL INTERFACE LANGUAGE

Integrated Circuit Card Interface Chip Language (ICCICL)

NAME	SYNTAX	ARGUMENTS	COMMENTS
IDENTIFICATION	?		Returns the String "ICCICL" for Identification and Functional Testing. There are no CR or LF Characters Transmitted.
SERIAL PORT COMMAND	-	abcd	Sends 4 Hex Characters to the LTC1955 Serial Port. "a" is the Most Significant Byte. Returns 4 Hex Characters from LTC1955 Serial Port. No Termination Character is Returned.
GET ATR	\		Calls "Set R _{IN} " Calls "Receive Block"
RECEIVE BLOCK	<		Polls Smart Card I/O Pin for Up to ~9600 ETU per Character. After the Last Character is Received the Entire Block is Returned Followed by a LF. Up to 32 Characters may be Received per Block.
SET R _{IN}	!		Sets the R _{IN} Pin of the LTC1955 High.
CLR R _{IN}	@		Sets the R _{IN} Pin of the LTC1955 Low.
SET SYNC	#		Sets the SYNC Pin of the LTC1955 High. For Use with Synchronous Memory Cards.
CLR SYNC	\$		Sets the SYNC Pin of the LTC1955 Low. This Will Only be Used on Synchronous Memory Cards.
WRITE PORT B	^	ab	Provides Direct Access to All of PORT B on the 68HC711e9. May be Used As General Purpose Output. "a" is the Most Significant Byte.
CHANGE ETU	+	abcd	Changes the ETU (Elementary Time Unit) Used by the RECEIVE BLOCK Commands. "a" is the Most Significant Byte. The Value is Assumed to be Hexadecimal.
READ DATA	=		Returns "1" if DATA is High and "0" if DATA is Low.
SET DATA TO 0	*		Forces the DATA Pin of the LTC1955 Low. For Use with Synchronous Memory Cards.
SET DATA TO 1	%		Forces the DATA Pin of the LTC1955 to High Impedance. For Use with Synchronous Memory Cards.

DEMO MANUAL DC465

RS232 DUAL SMART CARD INTERFACE

OPERATION

APPENDIX B THE LTC1955 SERIAL PORT COMMANDS

Table 1. Serial Port Commands

	STATUS OUTPUT	BIT	COMMAND INPUT
CARD B	0	D0	V _{CCB} Options
	0	D1	(See Table 2)
	0	D2	Card B Select/Deselect
	0	D3	Data Pull-Up Defeat
	Card B Electrical Fault	D4	Reserved (Always Set to "0")
	Card B ATR Fault	D5	Card B Clock Options
	Card B V _{CC} Ready	D6	(See Table 3)
	Card B Present	D7	
CARD A	0	D8	V _{CCA} Options
	0	D9	(See Table 2)
	0	D10	Card A Select/Deselect
	0	D11	Card A Communications Options (See Table 4)
	Card A Electrical Fault	D12	Card A Clock Options
	Card A ATR Fault	D13	(See Table 3)
	Card A V _{CC} Ready	D14	
	Card A Present	D15	

Table 2. V_{CC} and Shutdown Options

D9 D1	D8 D0	STATUS (CARD A) STATUS (CARD B)
0	0	V _{CC} = 0V (Shutdown)
0	1	V _{CC} = 1.8V
1	0	V _{CC} = 3V
1	1	V _{CC} = 5V

Table 3. Clock Options

D7 D15	D6 D14	D5 D13	CLOCK MODE CARD B CLOCK MODE CARD A
0	0	0	Synchronous Mode
0	0	1	Unused
0	1	0	Asynchronous Stop Low
0	1	1	Asynchronous Stop High
1	0	0	Asynchronous +1
1	0	1	Asynchronous +2
1	1	0	Asynchronous +4
1	1	1	Asynchronous +8

Table 4. Card A Communications Options

D12	D11	CARD A COMMUNICATION MODE
0	0	Nothing Selected
0	1	C4A Connected to DATA Pin
1	0	C8A Connected to DATA Pin
1	1	I/O A Connected to DATA Pin

PCB LAYOUT AND FILM

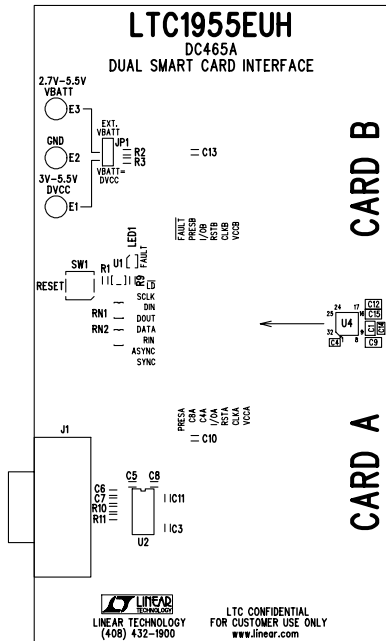

Top Silkscreen

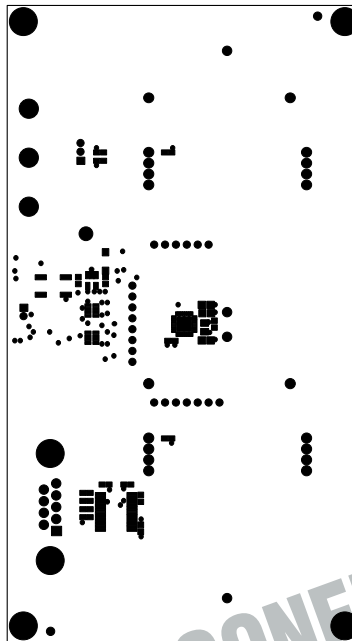

Top Solder Mask

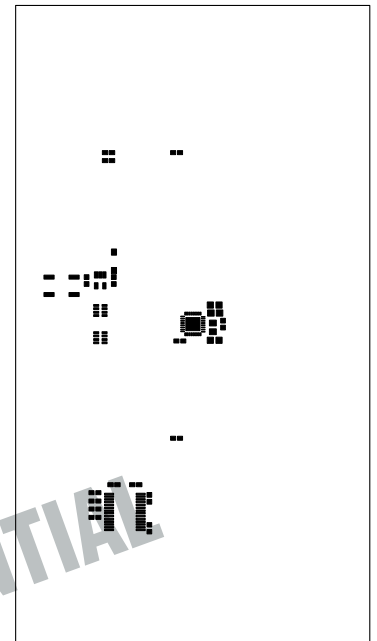

Top Solder Paste

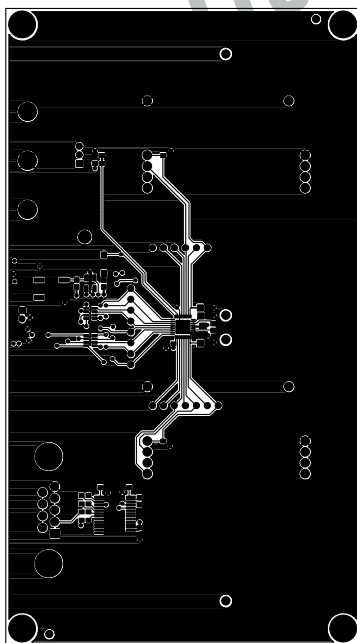

Layer 1 Top Layer

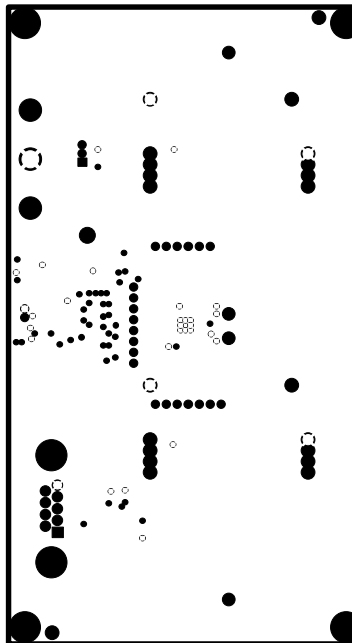

Layer 2 Ground Plane

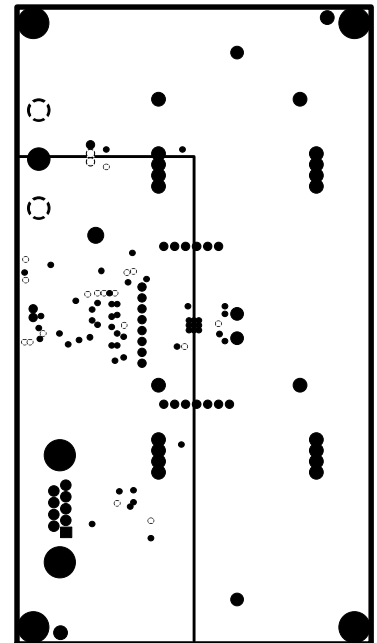

Layer 3 DV_{CC} V_{BATT} Plane

PCB LAYOUT AND FILM

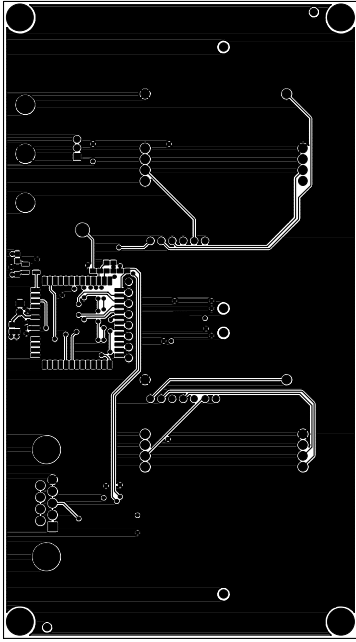

Layer 4 Bottom Layer

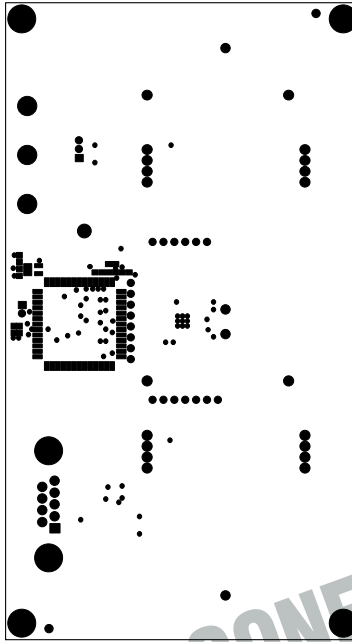

Bottom Solder Mask

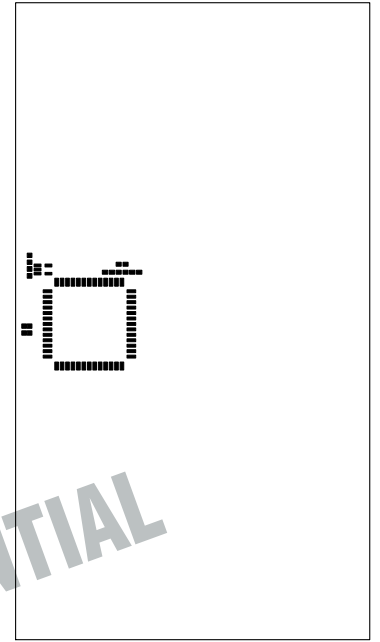

Bottom Solder Paste

LTC COMPANY CONFIDENTIAL

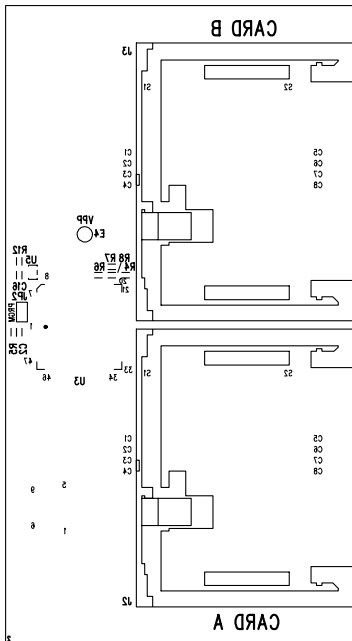

DEMO MANUAL DC465

RS232 DUAL SMART CARD INTERFACE

PC FAB DRAWING

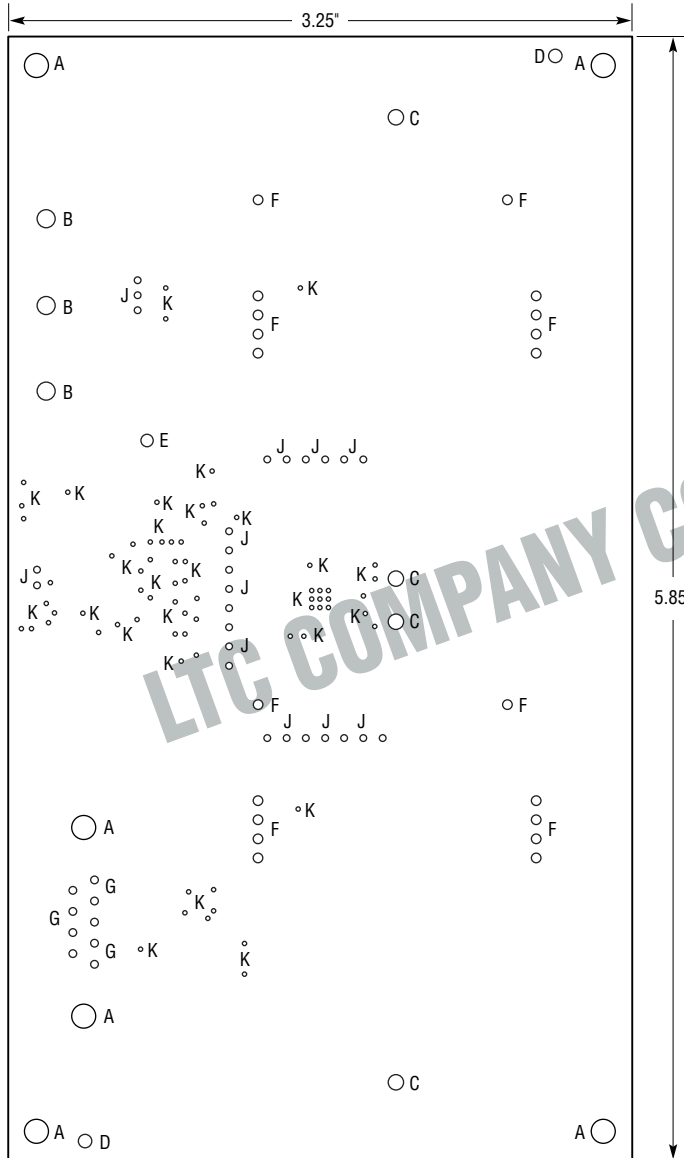

HOLE CHART

SYMBOL	DIAMETER	NUMBER OF HOLES	PLATED
A	0.125	6	YES
B	0.094	3	YES
C	0.080	4	YES
D	0.070	2	NO
E	0.064	1	YES
F	0.050	20	YES
G	0.040	9	YES
J	0.035	26	YES
K	0.015	71	
TOTAL HOLES		142	

NOTES: UNLESS OTHERWISE SPECIFIED

1. MATERIAL: FR4 OR EQUIVALENT EPOXY, 2 OZ COPPER CLAC THICKNESS 0.62 ±0.006 TOTAL OF 4 LAYERS
2. FINISH: ALL PLATED HOLES 0.001MIN/0.0015 MAX COPPER PLATE ELECTRODEPOSITED TIN-LEAD COMPOSITION BEFORE RELOW, SOLDER MASK OVER BARE COPPER (SM08C)
3. SOLDER MASK: BOTH SIDES USING LPI OR EQUIVALENT
4. SILKSCREEN: USING WHITE NONCONDUCTIVE EPOXY INK
5. UNUSED SMD COMPONENTS SHOULD BE FREE OF SODLER
6. FILL UP ALL VIAS WITH SOLDER
7. SCORING:

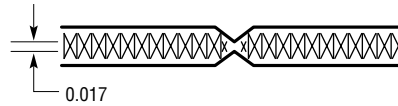

DC465 FAB DWG