

Application Note:

HFAN-04.5.3

Rev.1; 04/08

A Stressed Source for Testing 4Gbps 850nm FC Receivers

A Stressed Source for Testing 4Gbps 850nm FC Receivers

1 Overview

Error-free operation (with margin) of any fiber optic transmission link requires that the individual components of the link meet critical performance parameters. Given that many different vendors contribute various components to the link, it is important that they all interoperate with each other under worst-case conditions. This requirement becomes even more critical as the link data rates continue to increase while the cost demand per gigabit continues to decrease.

The fibre channel standard (among others such as gigabit Ethernet) has defined specifications and test methods to help insure interoperability of various vendors' components and to provide margin in the link for worst-case conditions. Jitter specifications have been allocated for each component in the link (serdes, transmitter, fiber, receiver, PWB etc). An important receiver test parameter often overlooked is the stressed-receiver sensitivity. Stressed testing is used to evaluate receiver performance under the estimated worst-case conditions of eye closure (also referred to as intersymbol interference or ISI). Examples of receivers have been seen by the author in which non-stressed (intrinsic) sensitivity performance appears satisfactory but upon performing a stress test, the receiver performance becomes unacceptable. A stressed test (time domain BER measurement) is more informative than just measuring the small signal bandwidth of the receiver.

Extensive link modeling in the standards committees over the years has come up with specifications for ISI and the required test power.

These values are primarily a function of the data rate, source edge speed, fiber characteristics and operating wavelength of the link. The largest ISI in 4Gbps FC is specified for 850nm 62µm(micron) fiber links (2.14 dB). This app note will focus on creating a stressed test source using a Maxim MAX3748 evaluation board, bias tee, Bessel Thompson (BT) filter and a 4Gbps 850nm VCSEL.

2 Requirements of the Stressed Eye.

The stressed eye is composed of both jitter and ISI components. Eye closure requirements are summarized as follows in Table 1 which are taken from the fiber channel specification. [1]

The Deterministic Jitter (DJ) specified in Table 1 is desired to be DJ due to duty cycle distortion or DCD. This form of DJ is considered the most demanding on a link since it introduces asymmetry in the vertical eye closure, effectively reducing the bandwidth of the system. One element in the link that might create DCD is the turn-on delay of the laser. This would result in a shorter ON duration and longer OFF duration.

Our interest here will focus on creating the 4.25Gbps stressed eye with worst-case closure for the 62-micron fiber. If the unit under test shows good performance under this condition, it should also work well for the 50-micron fiber. Figure 1 shows an "ideal" stressed eye that contains the ISI as well as about 0.085UI (20psec) of DJ due to DCD.

Table 1: Summary of Fiber Channel Jitter Requirements for Multimode Stressed Eye

MM Fiber Type	Vertical Eye Closure (dB) / DJ (psec) for Stressed Eye		
	100-M5 (1.06Gbps)	200-M5 (2.125Gbps)	400-M5 (4.25Gbps)
50 micron	0.96 / 80	1.26 / 40	1.67 / 20
62.5 micron	2.18 / 80	2.03 / 40	2.14 / 20

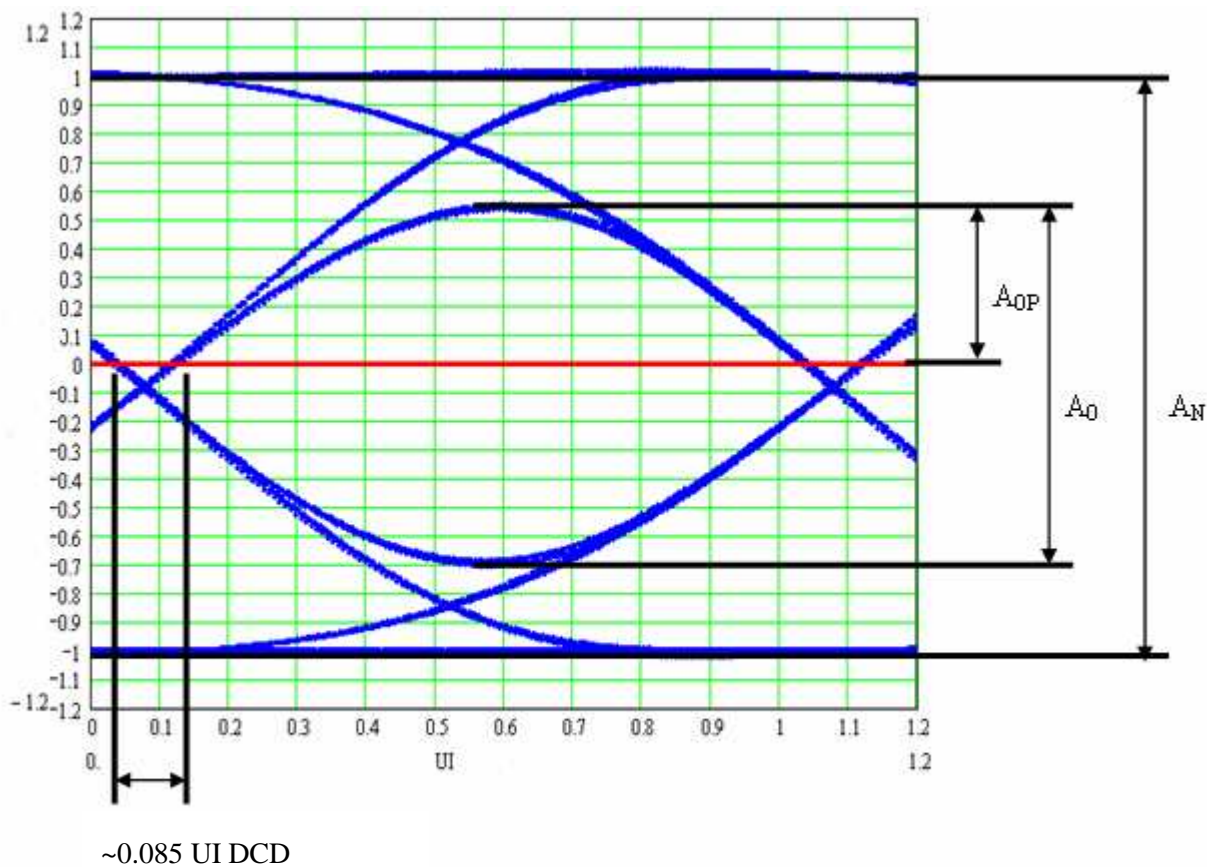

Figure 1: Simulated “ideal” stressed eye with both ISI and DCD DJ (horizontal axis scaled to Unit Intervals, UI) The ISI (closure) on logic one (A_{OP}) is noticeably greater than logic zero due to the DCD DJ.

The eye closure as defined in the standard_[1] is:

Vertical Eye Closure Penalty in dB

$$= -10 \times \log (A_0/A_N) \sim 2.1 \text{ dB} \quad (1)$$

Where A_0 and A_N are defined in Figure 1.

Constructing the above eye at 4.2Gbps using real components is challenging to say the least. A non-linear element (eg offset in a post amp) is required to generate the DCD. Plus it is unlikely one can generate pure DCD and not add any pattern jitter. A key characteristic of the above eye is that the vertical opening is asymmetrical with respect to the average value of zero. The effective eye closure including DCD is

Effective Vertical Closure [dB]

$$= -10 \times \log(2 \times A_{0P}/A_N) = 2.6 \text{ dB} \quad (2)$$

The bit error rate will be dominated by the closure that passes closest to the average value or slice threshold.

In the example in Figure 1 this closure is on the logic one level. The main requirement is to generate an eye that has a DJ component (may be pattern DJ), but that contains 2.6dB of effective vertical closure relative to average value on either the 1 level, 0 level or both.

Figure 2 shows the resulting simulated eye in which little or no DCD is present but there is about 0.09UI of pattern jitter. To obtain the same worst-case closure (2.6dB), when the DCD is present, it is necessary to slow the rise and fall times of the waveform down slightly, to add some additional closure to the eye.

Effective Vertical Closure (Fig 2)

$$= -10 \times \log(2 \times 0.55/2) = 2.6 \text{ dB} \quad (3)$$

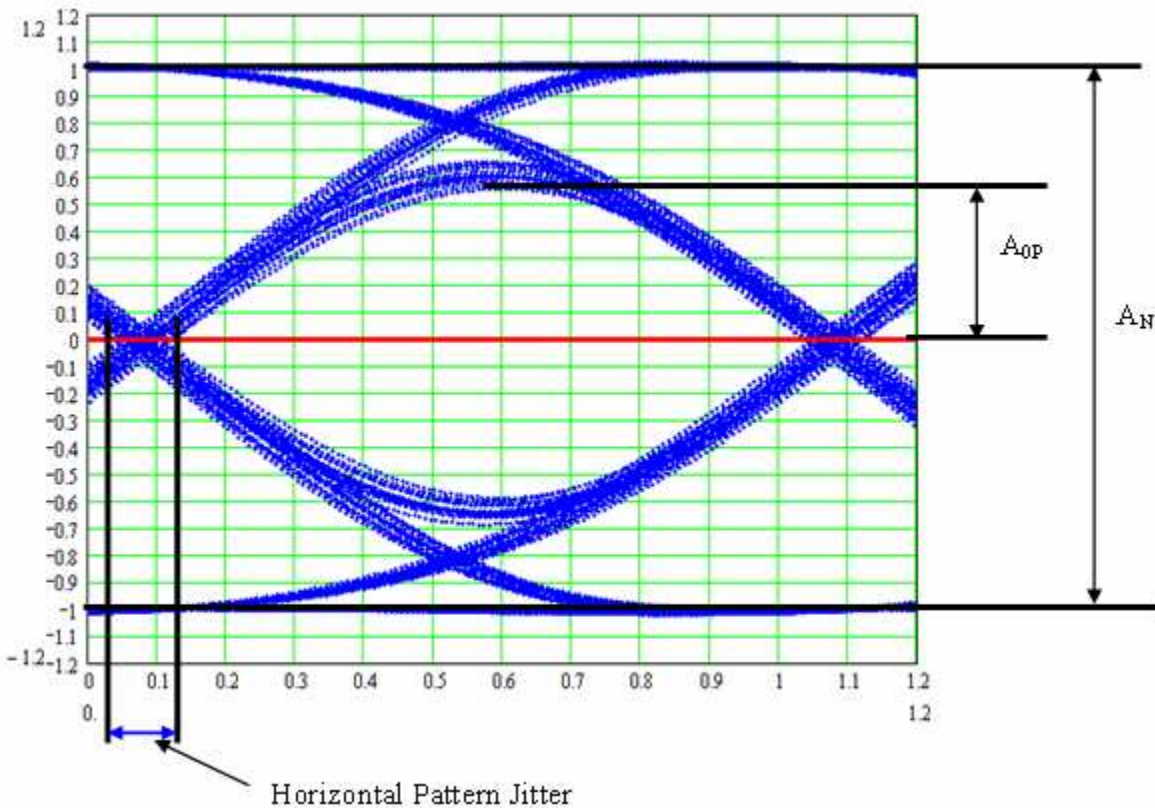

Figure 2 Simulated "approximated" stressed eye with about 2.6 dB ISI. There is little or no DCD DJ in this example The ISI (closure) on logic one is just slightly higher than logic zero.

3 Generating the Stressed Eye

Figure 3 shows the apparatus for generating and testing the stressed-eye performance. It is based on a similar block diagram contained within the fiber channel standard.

The major building blocks in the stressed-eye generation are

- 1) Low Pass Filter
- 2) Limiting Amplifier
- 3) 4th Order BT Filter
- 4) Bias Network
- 5) Connectorized VCSEL Laser

The first low-pass filter is used to generate the pattern DJ. It accomplishes this by slowing down the edge rate of the data sufficiently that pattern jitter results at the zero crossing of the limiting amp. The filter may either be a length of coax cable, or a lumped-element filter. A simple capacitor added across the input to the limiting amp can also create the necessary DJ. In the example that follows there is enough residual DJ, at 4.2Gbps, in the test system (pattern generator, post amp, and laser) that no additional filtering is required.

The limiting amplifier is then used to remove any ISI generated by the first filter and retain the DJ. If the first filter is not required, it should be possible to remove the limiting amp as well, provided the output level of the pattern generator is not allowed to vary. The MAX3748 limiting amp may be driven with a single-ended input with the unused input terminated in 50 ohms.

Following the limiting amp is the Bessel Thompson linear phase filter. This is the component responsible for adding the required amount of ISI. Filter bandwidth depends on the amount of ISI required, together with the inherent speed of the post amp, bias tee and the laser itself. Since these filters are fixed in value, it may be necessary to procure a few different models to obtain the desired ISI. Slight trimming may be possible by selecting a filter with marginally higher bandwidth and then adding a 0.5pF cap in parallel. (The addition of lumped elements external to the filter will impact the phase response and could create overshoot or distortion.)

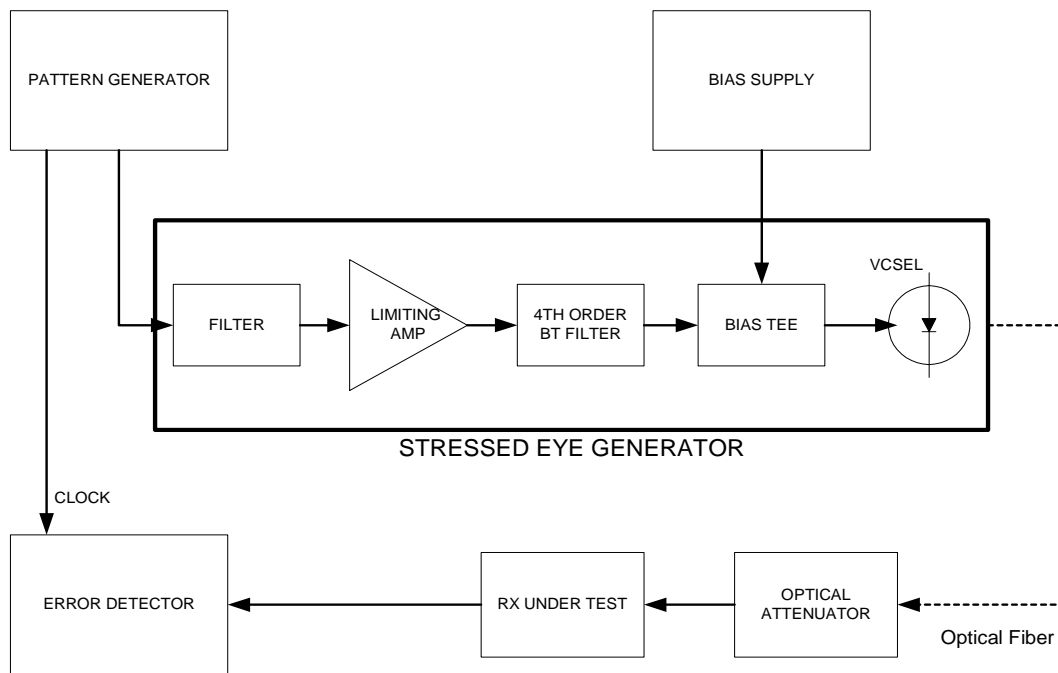

Figure 3 Block diagram showing the configuration for stressed-eye testing.

The broadband bias tee permits the injection of bias current from an external source. This may be a current source or just a voltage source with series resistor.

The VCSEL converts the electrical stressed eye into an optical one. A high-speed VCSEL is recommended otherwise it will start to alter the electrical stressed eye and require further adjustment of the waveform. The VCSEL leads are trimmed as short as possible and soldered to a PWB end launch connector.

Figure 4 contains a photograph of the major components used to generate the stressed eye.

From left to right they are the limiting amp, 4th order BT filter, bias tee, and VCSEL. There was enough residual DJ in the system that the addition of a filter or cap on the input to the post amp was not required.

Table 2 contains a list of the components used to generate the stressed eye.

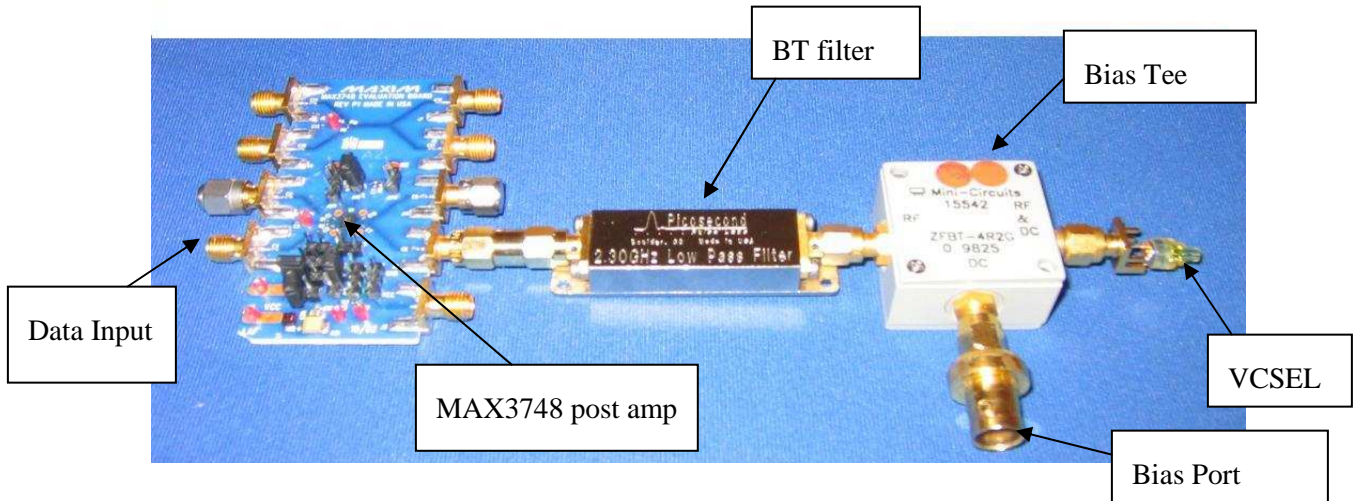

Figure 4 Photograph showing the stressed-eye components.

Table 2 : Components Used in the Stressed-Eye Generator

Item	Description
First DJ Filter	None required for this demo, however a small cap may be used (with 6dB pad) to generate additional DJ if required (eg 0.5pf)
Limiting Amp	MAX3748EVKIT Maxim evaluation kit for the MAX3748 post amp.
BT Filter	Picosecond Pulse labs 2.3GHz BT filter
Bias Tee	Mini Circuits ZFBT-4R2 series
4Gbps or faster VCSEL	Picolight PL-SLC-00-SG0-C0 Advanced Optical Components : HFE-4192-581
VCSEL Connector	End Launch SMA connector, Johnson 142-0701-801

Figure 5 shows the actual approximated stressed eye as measured with a high-speed Optical to Electrical Converter (O/E). Estimated BW of the O/E and scope is about 8GHz. A Fibre Channel 3360 bit test pattern known as CRPAT is recommended for stress testing of the optical link. The stressed eye in Figure 5 is the result of scanning all the bits in the test sequence. Maximum eye closure occurs on the logic one side and is about 2.5dB which is close to the target closure. The closure does not need to be exact. In a completely linear system, the error in the eye opening could simply be compensated by adjusting the stressed sensitivity spec. However, the RX stressed sensitivity can become nonlinear as the ISI is increased. This can be due to effects such as baseline wander in the receiver or relative intensity noise (RIN) in the transmitter.

The laser has been set up with a low extinction ratio (ER) of about 6dB. The drive level from the MAX3748 can be set to one of two levels by either connecting or removing jumper JU8. (remove jumper for 0.2V p-p , install for 0.4V p-p). Laser bias current (and ER) can be adjusted to achieve the best eye.

Some noise can be observed, especially in the logic-one portion of the eye. This is likely RIN which starts to accumulate on the scope display as the 3360 bits are scanned. RIN is a noise source associated with the transmitter and not the receiver. However, the presence of RIN on the transmit side will have a non-linear effect on receiver stressed sensitivity performance as eye closure increases. To bound the non-linear effects caused by transmitter RIN, a general rule-of-thumb is to maintain worst-case eye closure (TX + RX + fiber) to 3dB or less.

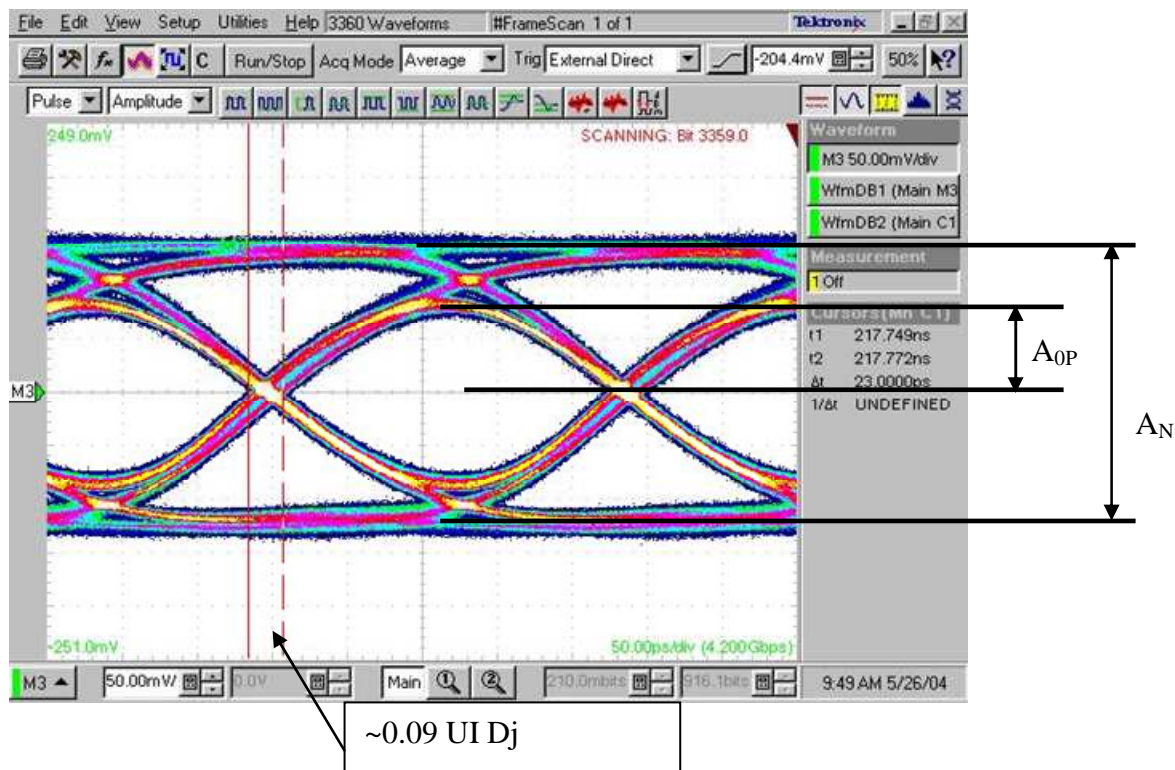

Figure 5 Stressed eye as measured with broad band O/E. Closure is about 2.5 dB.

4 Conducting a Stressed Test

Once the stressed eye has been configured, an actual stressed-sensitivity measurement can be performed using the set-up shown in Figure 3. The receiver (RX) under test in this example consists of a ROSA containing a Maxim TIA followed by a Maxim high-speed post amp. The stressed test will be evaluating the combined effects of ROSA and post amp.

Figure 6 shows the stressed-eye output taken from the ROSA without post amp (measured differentially). The estimated eye closure has increased to about 3dB from the 2.5dB measured on the stressed source. Some increase in eye closure is expected due to the band-limiting properties of the TIA when compared to a >8GHz reference receiver. There is also no significant increase in DJ observed, compared to that measured for the stressed source.

Figure 7 contains 2 BER curves taken at 4.2Gbps with CRPAT test pattern. The leftmost curve is taken using a high-speed, non-stressed 850nm

source. The rightmost curve was taken with the stressed eye generator and set-up of Figure 3. Horizontal axis is expressed in terms of optical modulation amplitude (OMA) in dBm. Extrapolating to a bit error ratio (BER) of 10^{-12} shows the stressed penalty to be between 3.5 and 4 dB. The horizontal separation between the two curves increases slightly with increasing power. This could be the result of the transmitter characteristic known as RIN discussed earlier, or some actual behavior of the receiver being tested. There is good margin between the estimated stressed sensitivity and the spec. However eye closure (3dB) is at the level suggested to limit non-linear effects resulting from RIN and mode partition noise. The passing margin is about 6dB relative to the $62\mu\text{m}$ spec. In order to meet the FC jitter requirements, a minimum of a 5dB margin is recommended. The RX tested in this example meets both of these requirements.

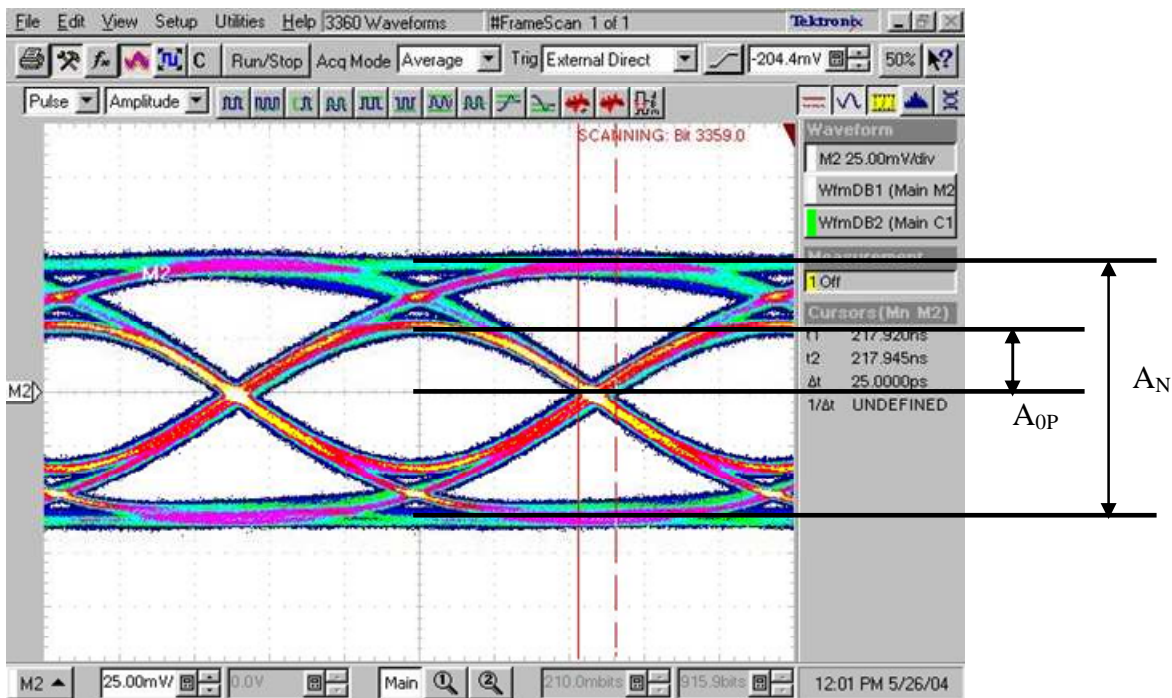

Figure 6: ROSA differential stressed output eye

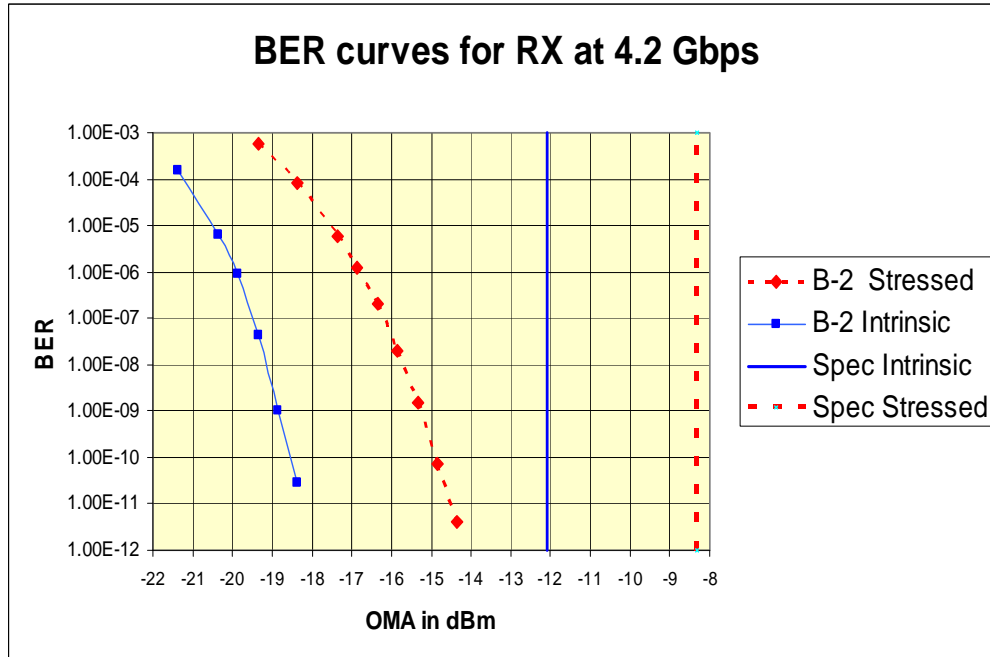

Figure 7 Intrinsic and stressed BER curves for the tested RX. Specs are also shown for the 62µm fiber example.

References:

[1] Fibre Channel Physical Interfaces FC PI-2 rev 4.1; American National Standard for Information Technology, March 24, 2004, pp. 33-53.

[2] David C Cunningham, William G Lane, Gigabit Ethernet Networking, Macmillan Technical Publishing, Indianapolis, 1999, pp. 301-336