



The Future of Analog IC Technology®

# MP8763

## High Efficiency, 12A, 18V, Synchronous, Step-Down Converter

### DESCRIPTION

The MP8763 is a fully-integrated, high-frequency, synchronous, rectified, step-down, switch-mode converter. It offers a very compact solution to achieve a 12A output current over a wide input-supply range with excellent load and line regulation. The MP8763 operates at high efficiency over a wide output-current load range.

The MP8763 uses Constant-On-Time (COT) control mode to provide fast transient response and ease loop stabilization.

An external resistor programs the operating frequency from 200kHz to 1MHz. The frequency stays nearly constant as the input supply varies with the feed-forward compensation.

The default under voltage lockout threshold is internally set at less than 4.1V, but a resistor network on the enable pin can increase this threshold. The soft start pin controls the output voltage startup ramp. An open drain power good signal indicates that the output is within nominal voltage range.

It has full integrated protection features that include over-current protection, over-voltage protection and thermal shutdown.

The MP8763 is available in a 3mm×4mm QFN package, and requires a minimal number of readily-available components.

### FEATURES

- 2.5V to 18V Operating Input Range with External 5V Bias
- 4.5V to 18V Operating Input Range with Internal Bias
- 12A Output Current
- Low  $R_{DS(ON)}$  Internal Power MOSFETs
- Proprietary Switching-Loss-Reduction Technique
- Adaptive COT for Ultrafast Transient Response
- 1% Reference Voltage Over Junction Temperature Range (0°C to +125°C)
- Programmable Soft-Start Time
- Pre-Bias Start-Up
- Programmable Switching Frequency from 200kHz to 1MHz
- Non-Latch OCP, OVP, and Thermal Shutdown
- Output Adjustable from 0.611V to 13V

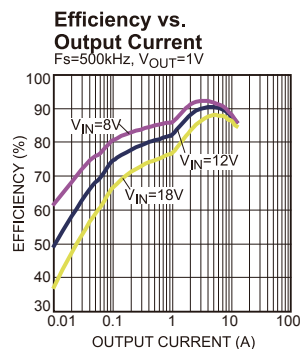
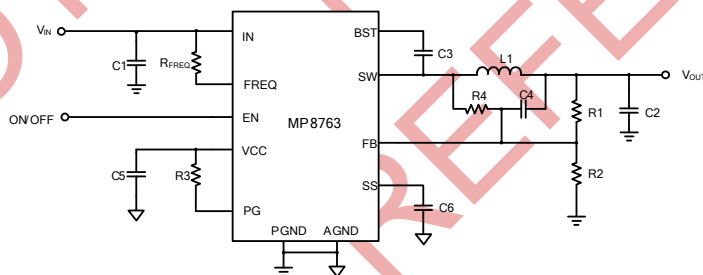
### APPLICATIONS

- Set-Top Boxes
- XDSL Modem/DSLAM
- Small-Cell Base Stations
- Personal Video Recorders
- Flat-Panel Televisions and Monitors
- Distributed Power Systems

All MPS parts are lead-free, halogen free, and adhere to the RoHS directive. For MPS green status, please visit MPS website under Quality Assurance.

"MPS" and "The Future of Analog IC Technology" are Registered Trademarks of Monolithic Power Systems, Inc.

### TYPICAL APPLICATION



### ORDERING INFORMATION

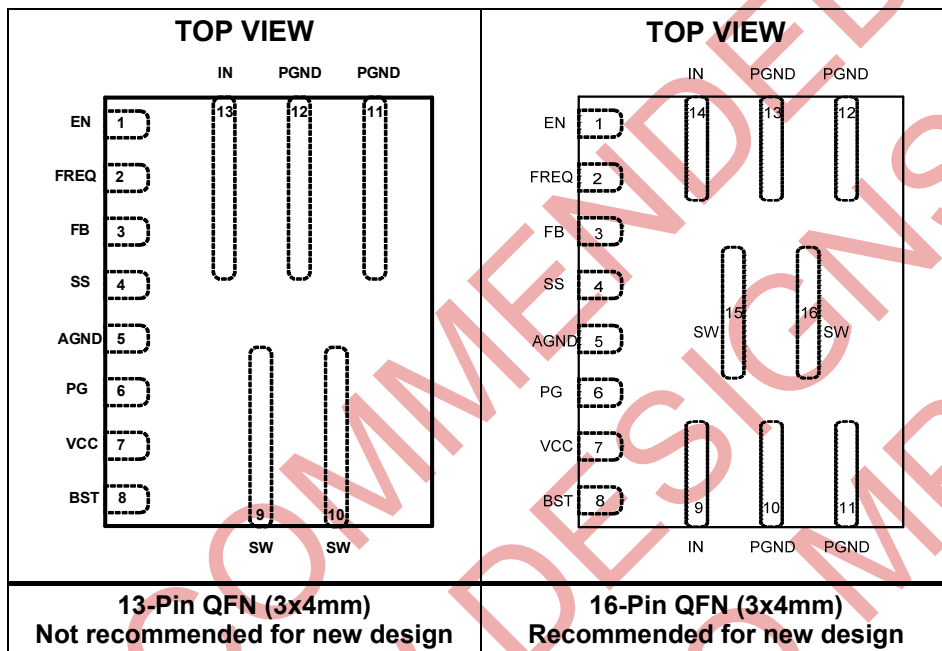
Part Number	Package	Top Marking
MP8763GL*	QFN-13(3mm×4mm)	MP8763
MP8763GLE**	QFN-16(3mm×4mm)	MP8763E

\* For Tape & Reel, add suffix -Z (e.g. MP8763GL-Z)

\*\* For Tape & Reel, add suffix -Z (e.g. MP8763GLE-Z)

**Note: The 16-pin QFN package is preferred and recommended for new designs**

### PACKAGE REFERENCE



#### ABSOLUTE MAXIMUM RATINGS <sup>(1)</sup>

Supply Voltage $V_{IN}$ .....	21V
$V_{SW}$ .....	-0.3V to $V_{IN} + 0.3V$
$V_{SW}$ (30ns).....	-3V to $V_{IN} + 3V$
$V_{BST}$ .....	$V_{SW} + 6V$
Enable Current $I_{EN}$ <sup>(2)</sup> .....	2.5mA
All Other Pins .....	-0.3V to +6V
Continuous Power Dissipation ( $T_A=+25^\circ$ ) <sup>(3)</sup>	
QFN3×4.....	2.7W
Junction Temperature.....	150°C
Lead Temperature .....	260°C
Storage Temperature.....	-65°C to +150°C

#### Recommended Operating Conditions <sup>(4)</sup>

Supply Voltage $V_{IN}$ .....	4.5V to 18V
Output Voltage $V_{OUT}$ .....	0.611V to 13V
$I_{EN}$ .....	0mA to 1mA
Operating Junction Temp. ( $T_J$ ).....	-40°C to +125°C

Follow Layout Recommendation for Best Performance

Thermal Resistance <sup>(5)</sup>	$\theta_{JA}$	$\theta_{JC}$
QFN (3mm×4mm).....	46	9 °C/W

#### Notes:

- Exceeding these ratings may damage the device.
- Refer to the section "Configuring the EN Control".
- The maximum allowable power dissipation is a function of the maximum junction temperature  $T_{J(MAX)}$ , the junction-to-ambient thermal resistance  $\theta_{JA}$ , and the ambient temperature  $T_A$ . The maximum allowable continuous power dissipation at any ambient temperature is calculated by  $P_D(MAX)=(T_{J(MAX)}-T_A)/\theta_{JA}$ . Exceeding the maximum allowable power dissipation will cause excessive die temperature, and the regulator will go into thermal shutdown. Internal thermal shutdown circuitry protects the device from permanent damage.
- The device is not guaranteed to function outside of its operating conditions.
- Measured on JESD51-7, 4-layer PCB.

**ELECTRICAL CHARACTERISTICS**
**V<sub>IN</sub> = 12V, T<sub>J</sub> = +25°C, unless otherwise noted.**

Parameters	Symbol	Condition	Min	Typ	Max	Units
<b>Supply Current</b>						
Supply Current (Shutdown)	I <sub>IN</sub>	V <sub>EN</sub> = 0V		0	1	μA
Supply Current (Quiescent)	I <sub>IN</sub>	V <sub>EN</sub> = 2V, V <sub>FB</sub> = 1V	760	860	1000	μA
<b>MOSFET</b>						
High-Side Switch-On Resistance	HS <sub>RDS-ON</sub>	T <sub>J</sub> = 25°C		19.6		mΩ
Low-Side Switch-On Resistance	LS <sub>RDS-ON</sub>	T <sub>J</sub> = 25°C		5.2		mΩ
Switch Leakage	SW <sub>LKG</sub>	V <sub>EN</sub> = 0V, V <sub>SW</sub> = 0V or 12V		0	1	μA
<b>Current Limit</b>						
Low-Side Valley Current Limit <sup>(6)</sup>	I <sub>LIMIT_VALLEY</sub>		12	15	18	A
Low-Side Negative Current Limit <sup>(6)</sup>	I <sub>LIMIT_NEGATIVE</sub>		-4	-2.5	-1	A
<b>Timer</b>						
One-Shot ON Time	τ <sub>ON</sub>	R <sub>FREQ</sub> = 453kΩ, V <sub>OUT</sub> = 1.2V		250		ns
Minimum ON Time <sup>(6)</sup>	τ <sub>ON_MIN</sub>			30		ns
Minimum OFF Time <sup>(6)</sup>	τ <sub>OFF_MIN</sub>			360		ns
<b>Over-Voltage and Under-Voltage Protection</b>						
OVP Non-Latch Threshold	V <sub>OVP_NON-LATCH</sub>		117%	120%	123%	V <sub>FB</sub>
OVP Delay	τ <sub>OVP</sub>			2		μs
UVP Threshold <sup>(6)</sup>	V <sub>UVP</sub>			50%		V <sub>FB</sub>
<b>Reference And Soft-Start</b>						
Reference Voltage	V <sub>REF</sub>	T <sub>J</sub> = -40°C to +125°C <sup>(7)</sup>	602	611	620	mV
		T <sub>J</sub> = -0°C to +125°C <sup>(7)</sup>	605	611	617	
		T <sub>J</sub> = +25°C	605	611	617	
Feedback Current	I <sub>FB</sub>	V <sub>FB</sub> = 650mV		50	100	nA
Soft-Start Charging Current	I <sub>SS</sub>	V <sub>SS</sub> = 0V	16	20	25	μA
<b>Enable And UVLO</b>						
Enable Input High Voltage	V <sub>IHEN</sub>		1.1	1.3	1.5	V
Enable Hysteresis	V <sub>EN-HYS</sub>			250		mV
Enable Input Current	I <sub>EN</sub>	V <sub>EN</sub> = 2V		0		μA
		V <sub>EN</sub> = 0V		0		

**ELECTRICAL CHARACTERISTICS (continued)**
**V<sub>IN</sub> = 12V, T<sub>J</sub> = +25°C, unless otherwise noted.**

Parameters	Symbol	Condition	Min	Typ	Max	Units
<b>VCC Regulator</b>						
VCC Under-Voltage Lockout Threshold Rising	VCC <sub>Vth</sub>		3.75	3.9	4.05	V
VCC Under-Voltage Lockout Threshold Hysteresis	VCC <sub>HYS</sub>			500		mV
VCC Regulator	V <sub>CC</sub>		4.65	4.8	4.95	V
VCC Load Regulation		I <sub>CC</sub> =5mA		0.5		%
<b>Power Good</b>						
Power-Good, Rising Threshold	PG <sub>Vth-Hi</sub>		87%	91%	94%	V <sub>FB</sub>
Power-Good, Falling Threshold	PG <sub>Vth-Lo</sub>			80%		V <sub>FB</sub>
Power-Good, Low-to-High Delay	PG <sub>Td</sub>			2.5		ms
Power Good, Sink Current Capability	V <sub>PG</sub>	Sink 4mA			0.4	V
Power Good, Leakage Current	I <sub>PG_LEAK</sub>	V <sub>PG</sub> = 3.3V		10	100	nA
<b>Thermal Protection</b>						
Thermal Shutdown <sup>(6)</sup>	T <sub>SD</sub>		150			°C
Thermal Shutdown Hysteresis <sup>(6)</sup>				25		°C

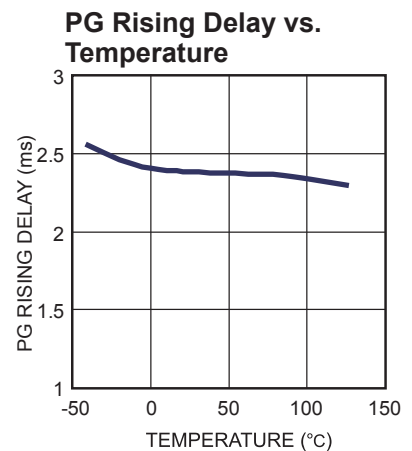
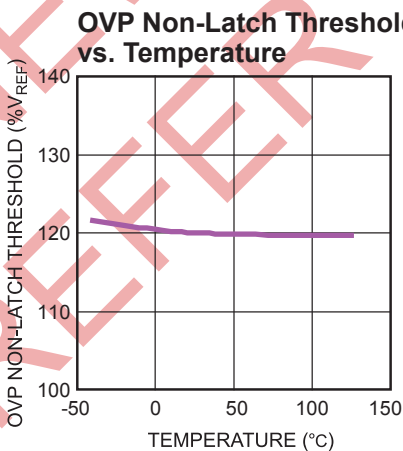
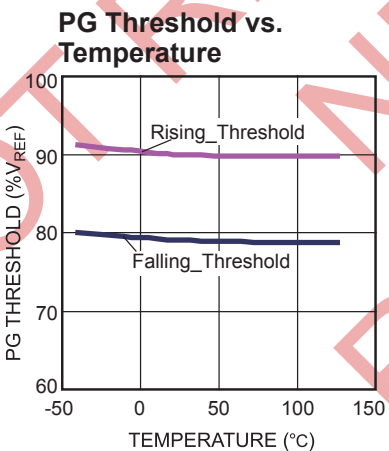
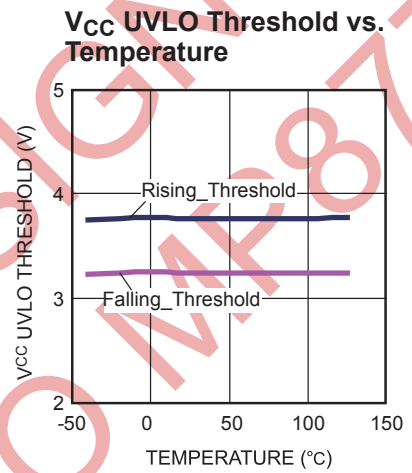
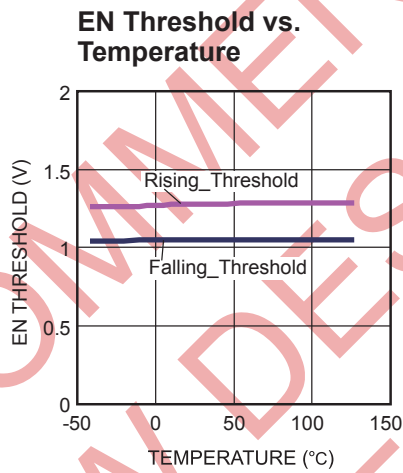
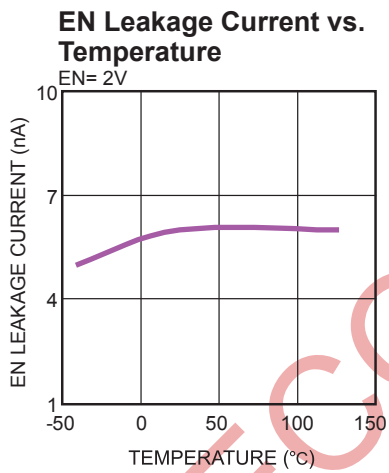
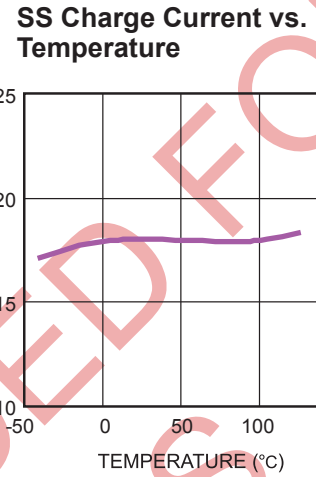
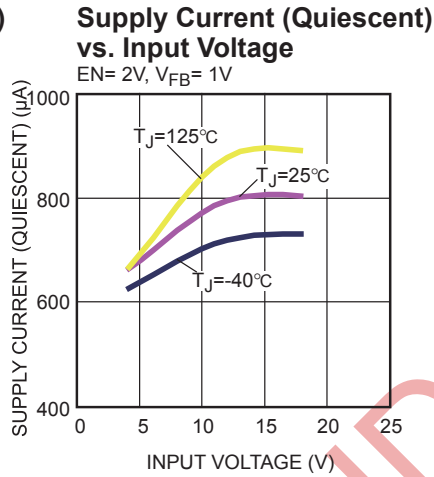
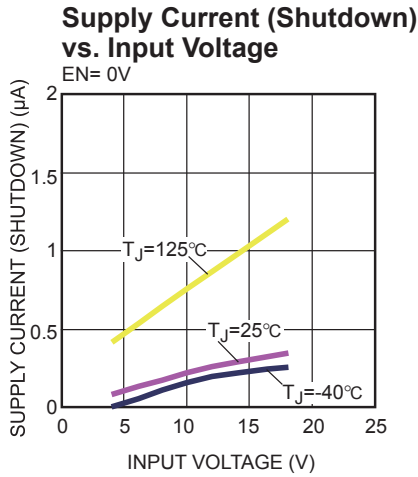
**Note:**

6) Guaranteed by design.

7) Not production test, guaranteed by characterization

**PIN FUNCTIONS**

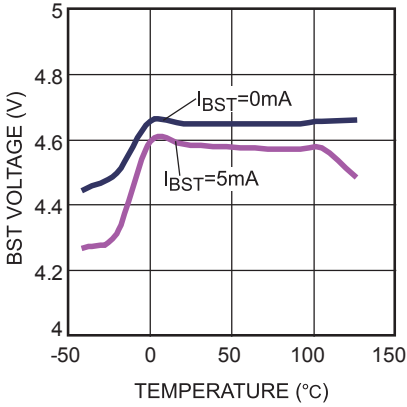
PIN # 13-Pin QFN	PIN# 16-Pin QFN	Name	Description
1	1	EN	Enable. Digital input to turn the regulator ON or OFF. Drive EN HIGH to turn on the regulator. Drive it LOW to turn it off. Connect EN to IN through a pull-up resistor or a resistive voltage divider for automatic startup. Do not float this pin.
2	2	FREQ	Frequency Set. Requires a resistor connected between FREQ and IN to set the switching frequency. The input voltage and the resistor connected to the FREQ pin determine the ON time. The connection to the IN pin provides line feed-forward and stabilizes the frequency during input voltage variation.
3	3	FB	Feedback. Connect to the tab of an external resistor divider from the output to GND to set the output voltage. FB is also configured to realize over-voltage protection (OVP) by monitoring output voltage. Place the resistor divider as close to FB pin as possible. Avoid using vias on the FB traces.
4	4	SS	Soft-Start. Connect an external capacitor to program the soft start time for the switch mode regulator.
5	5	AGND	Analog ground. The control circuit reference.
6	6	PG	Power Good, the output is an open drain signal. Require a pull-up resistor to a DC voltage to indicate high if the output voltage exceeds 91% of the nominal voltage. There is a delay from $FB \geq 91\%$ to PG goes high.
7	7	VCC	Internal 4.8V LDO output. Power the driver and control circuits. 5V external bias can disable the internal LDO. Decoupling with $\geq 1\mu F$ ceramic capacitor as close to the pin as possible. Use X7R or X5R dielectric ceramic capacitors for their stable temperature characteristics.
8	8	BST	Bootstrap. Require a capacitor connected between SW and BST pins to form a floating supply across the high-side switch driver.
9, 10	15, 16	SW	Switch Output. Connect to the inductor and bootstrap capacitor. The high-side switch drives the pin up to the $V_{IN}$ voltage during PWM duty cycle's ON time. The inductor current drives the SW pin negative during the OFF-time. The low-side switch's ON-resistance and the internal Schottky diode clamp the negative voltage. Connect using wide PCB traces
11, 12	10, 11, 12, 13	PGND	System Ground. Reference ground of the regulated output voltage. PCB layout requires extra care. Connect using wide PCB traces.
13	9, 14	IN	Supply Voltage. Supplies power to the internal MOSFET and regulator. The MP8763 operates from a +2.5V to +18V input rail with 5V external bias and a +4.5V to +18V input rail with internal bias. Requires an input decoupling capacitor. Connect using wide PCB traces and multiple vias.

**TYPICAL CHARACTERISTICS**
**V<sub>IN</sub> = 12V, V<sub>OUT</sub> = 1V, L = 1μH, T<sub>A</sub> = 25°C, unless otherwise noted.**


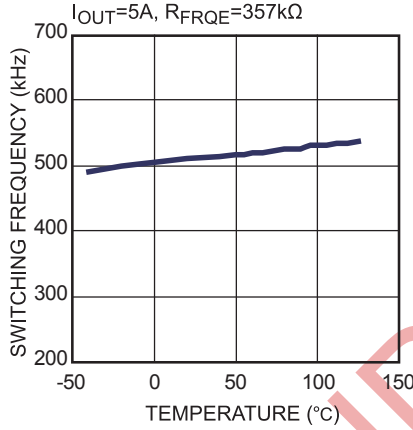
**TYPICAL CHARACTERISTICS** *(continued)*

$V_{IN} = 12V$ ,  $V_{OUT} = 1V$ ,  $L = 1\mu H$ ,  $T_A = 25^\circ C$ , unless otherwise noted.

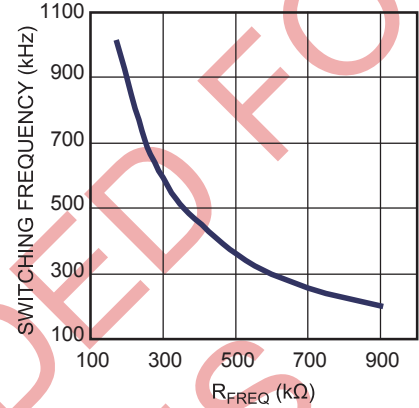
**BST Voltage vs. Temperature**



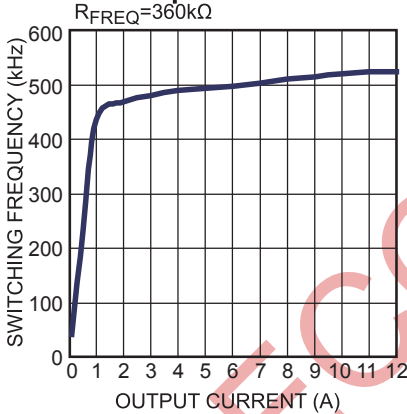
**Switching Frequency vs. Temperature**



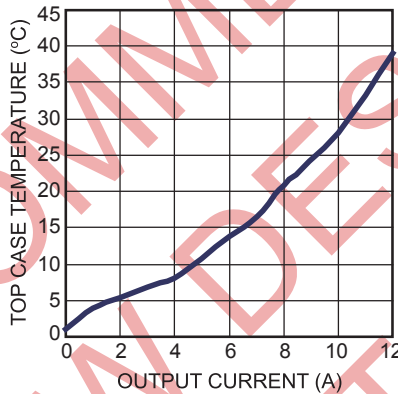
**Switching Frequency vs. R\_FREQ**



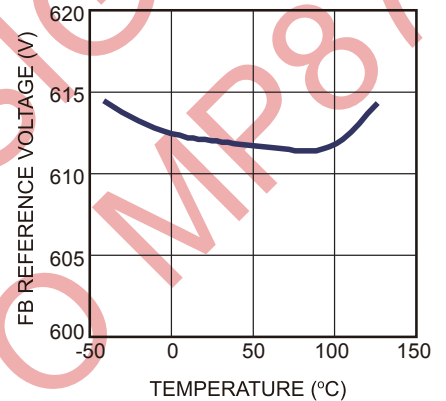
**Switching Frequency vs. Output Current**



**Case Temperature Rise vs. Output Current**



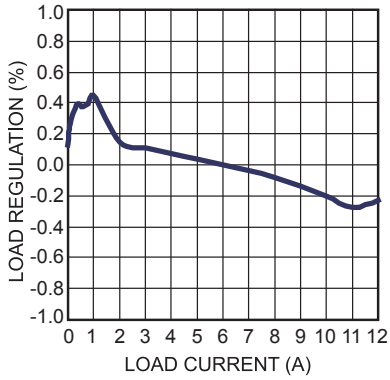
**FB Reference Voltage vs. Temperature**



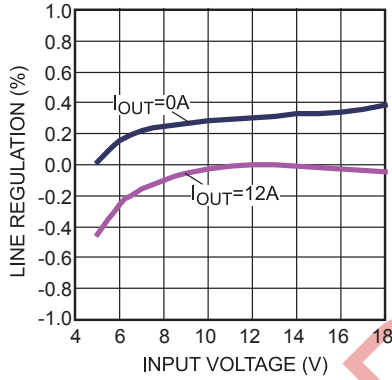
## TYPICAL PERFORMANCE CHARACTERISTICS

$V_{IN} = 12V$ ,  $V_{OUT} = 1V$ ,  $L = 1\mu H$ ,  $T_A = 25^\circ C$ , unless otherwise noted.

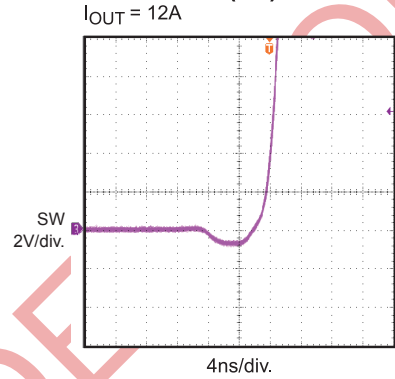
**Load Regulation**



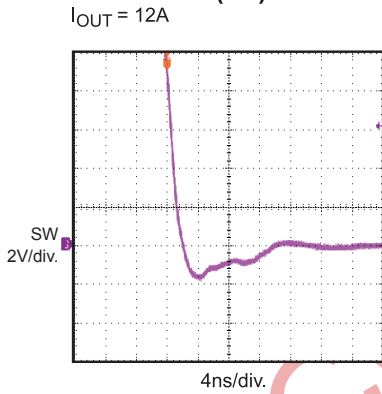
**Line Regulation**



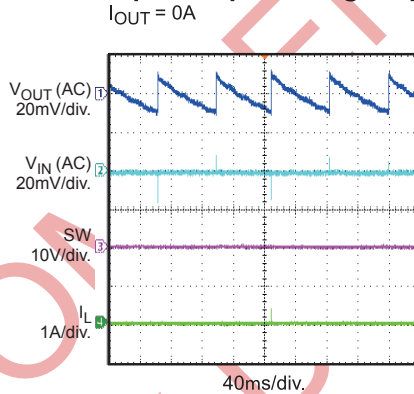
**Dead Time (on)**



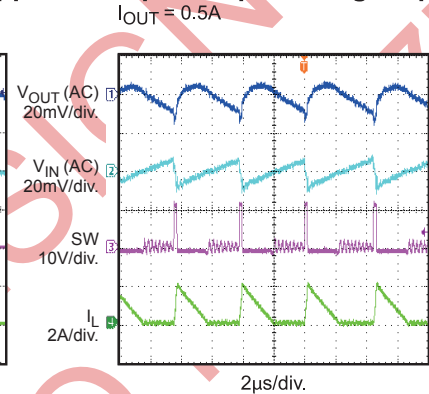
**Dead Time (off)**



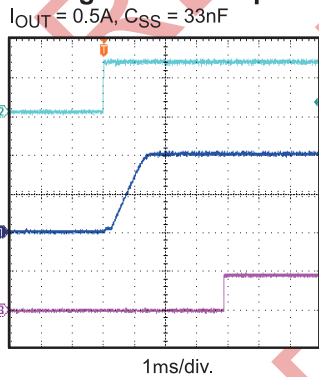
**Input/Output Voltage Ripple**



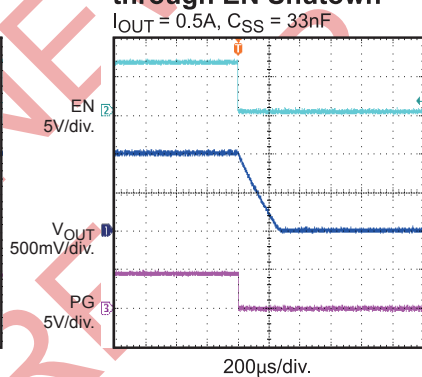
**Input/Output Voltage Ripple**



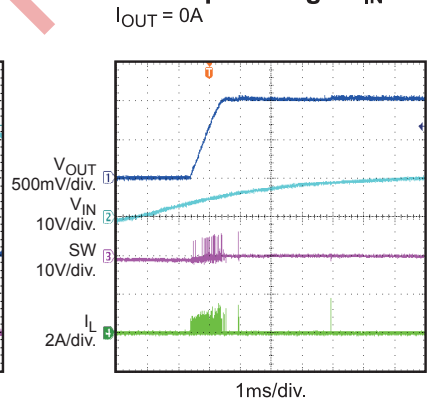
**Power Good through EN Start Up**



**Power Good through EN Shutown**



**Start Up Through  $V_{IN}$**

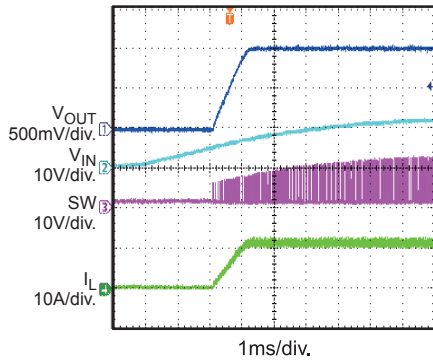




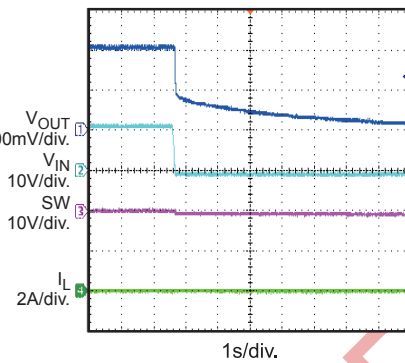
**TYPICAL PERFORMANCE CHARACTERISTICS (continued)**

$V_{IN}=12V$ ,  $V_{OUT}=1V$ ,  $L=1\mu H$ ,  $T_A=+25^\circ C$ , unless otherwise noted.

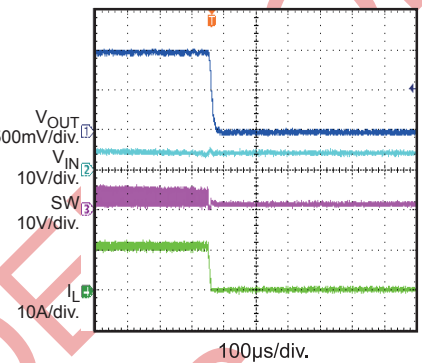
**Start Up Through  $V_{IN}$**   
 $I_{OUT} = 12A$



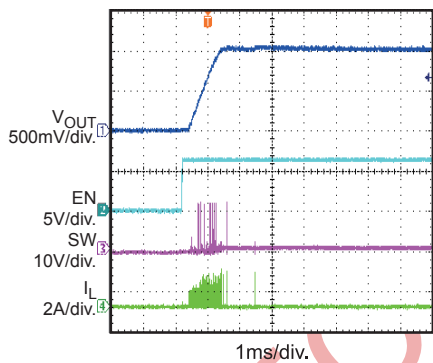
**Shutdown Through  $V_{IN}$**   
 $I_{OUT} = 0A$



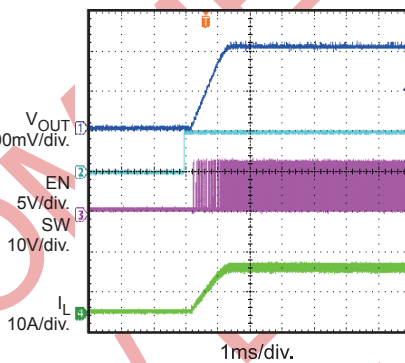
**Shutdown Through  $V_{IN}$**   
 $I_{OUT} = 12A$



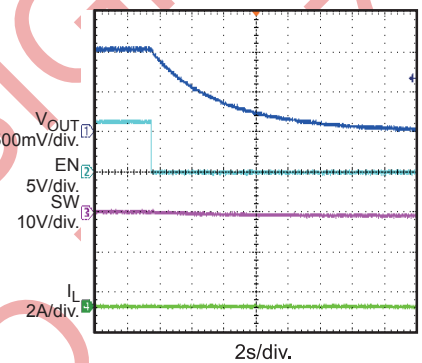
**Start up through EN**  
 $I_{OUT} = 0A$



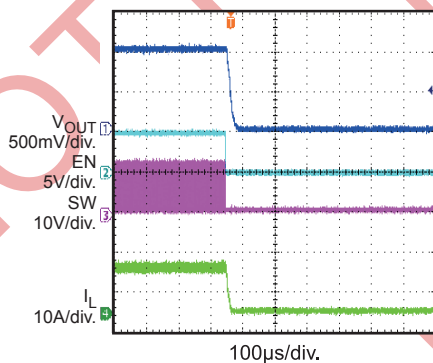
**Start up through EN**  
 $I_{OUT} = 12A$



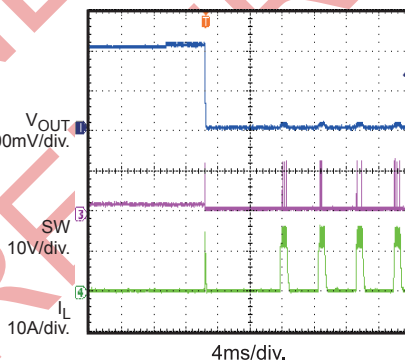
**Shutdown Through EN**  
 $I_{OUT} = 0A$



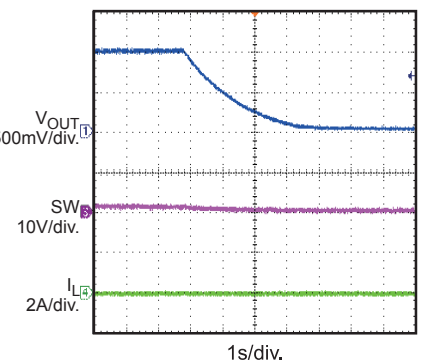
**Shutdown Through EN**  
 $I_{OUT} = 12A$



**Short Circuit Protection**



**Thermal Shutdown**  
 $I_{OUT} = 0A$

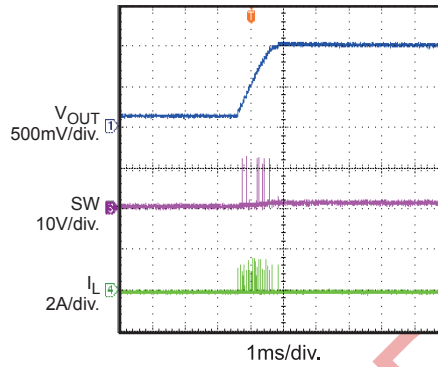


**TYPICAL PERFORMANCE CHARACTERISTICS** *(continued)*

$V_{IN}=12V$ ,  $V_{OUT}=1V$ ,  $L=1\mu H$ ,  $T_A=+25^{\circ}C$ , unless otherwise noted.

**Thermal Recovery**

$I_{OUT} = 0A$



NOT RECOMMENDED FOR NEW DESIGNS REFER TO MP8772



**OPERATION**

**PWM Operation**

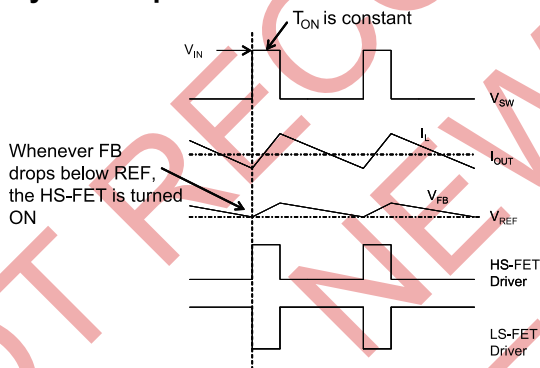
The MP8763 is a fully-integrated, synchronous, rectified, step-down, switch-mode converter. It uses constant-on-time (COT) control to provide a fast transient response and ease loop stabilization.

At the beginning of each cycle, the high-side MOSFET (HS-FET) turns ON when the feedback voltage ( $V_{FB}$ ) drops below the reference voltage ( $V_{REF}$ ), which indicates an insufficient output voltage. The input voltage and the frequency-set resistor determine the ON period as follows:

$$\tau_{ON}(\text{ns}) = \frac{6.1 \times R_{FREQ}(\text{k}\Omega)}{V_{IN}(\text{V}) - 0.4} \quad (1)$$

After the ON period elapses, the HS-FET turns off. It turns ON again when  $V_{FB}$  drops below  $V_{REF}$ . By repeating this operation, the converter regulates the output voltage. The integrated low-side MOSFET (LS-FET) turns ON when the HS-FET is OFF to minimize conduction loss and avoid a dead short (or shoot-through) between input and GND if both HS-FET and LS-FET turn on at the same time. An internally-generated dead-time (DT) between HS-FET OFF and LS-FET ON or LS-FET OFF and HS-FET ON avoids shoot-through.

**Heavy-Load Operation**



**Figure 2: Heavy-Load Operation**

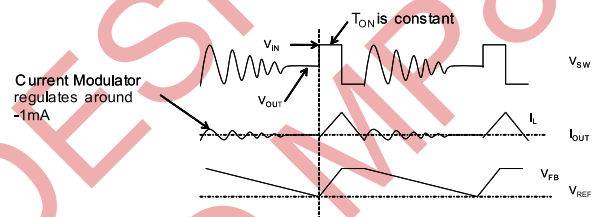
When the output current is high and the inductor current is always above zero amps, it is called continuous-conduction-mode (CCM). Figure 2 shows the CCM operation. When  $V_{FB} < V_{REF}$ , HS-FET turns ON for a fixed interval determined by the one-shot ON-timer as per equation 1. When the HS-FET turns OFF, the LS-FET turns ON until the next period.

In CCM, the switching frequency is fairly constant and it is also called PWM mode.

**Light-Load Operation**

As the load decreases, the inductor current decreases. The operation transitions from CCM to discontinuous-conduction-mode (DCM) when the inductor current reaches 0A.

Figure 3 shows light-load operation. When  $V_{FB}$  drops below  $V_{REF}$ , HS-FET turns ON for a fixed interval determined by the one-shot ON-timer as per equation 1. When the HS-FET turns OFF, the LS-FET turns ON until the inductor current reaches zero. In DCM, the  $V_{FB}$  does not reach  $V_{REF}$  when the inductor current reaches zero: Instead, the LS-FET driver enters tri-state (high Z). A current modulator then controls the LS-FET and limits the inductor current to less than  $-1\text{mA}$ . Hence, the output capacitors discharge slowly to GND through LS-FET, and the HS-FET doesn't turn ON as frequently as under heavy-load conditions, thus greatly improving light-load and no-load efficiency. This is called skip mode.



**Figure 3: Light-Load Operation**

As the output current increases from the light-load, the current modulator shortens the operating period to turn the HS-FET ON more frequently. Hence, the switching frequency increases. The output current reaches its critical threshold when the current modulator time decreases to zero. Determine the critical output current level as follows:

$$I_{OUT} = \frac{(V_{IN} - V_{OUT}) \times V_{OUT}}{2 \times L \times f_{SW} \times V_{IN}} \quad (2)$$

Where  $f_{SW}$  is the switching frequency.

The IC enters PWM mode once the output current exceeds its critical level. Then the switching frequency stays fairly constant over the output current range.

**Switching Frequency**

Selecting the switching frequency requires trading off between efficiency and component size. Low-frequency operation increases efficiency by reducing MOSFET switching losses, but requires larger inductor and capacitor values to minimize the output voltage ripple.

For the MP8763, set the ON time using the FREQ pin, thus setting the frequency for steady-state operation at CCM.

The MP8763 uses adaptive constant-on-time (COT) control, though the IC lacks a dedicated oscillator. Connect the FREQ pin to the IN pin through the resistor (R<sub>FREQ</sub>) so that the input voltage is feed-forwarded to the one-shot on-time timer. When operating in steady-state in CCM, the duty ratio stays at V<sub>OUT</sub>/V<sub>IN</sub> so the switching frequency is fairly constant over the input voltage range. Set switching frequency as follows:

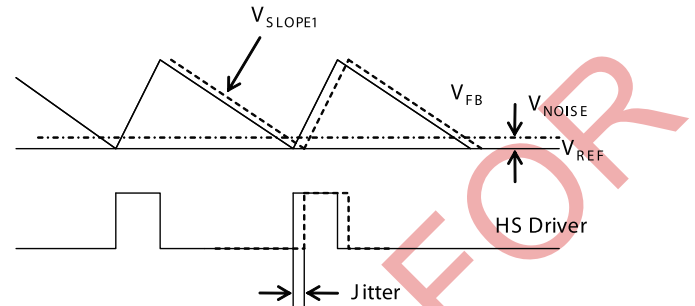
$$f_{SW} \text{ (kHz)} = \frac{10^6}{\frac{6.1 \times R_{FREQ} \text{ (k}\Omega)}{V_{IN} \text{ (V)} - 0.4} \times \frac{V_{IN} \text{ (V)}}{V_{OUT} \text{ (V)}} + \tau_{DELAY} \text{ (ns)}} \tag{3}$$

Where  $\tau_{DELAY}$  is the comparator delay (~5ns). After adding load, the frequency may be affected a little because power MOSFET voltage drop will affect the duty cycle.

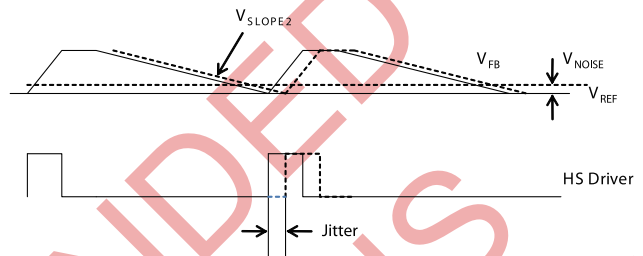
Typically, the MP8763 is set between 200kHz and 1MHz. It is optimized to operate efficiently at high switching frequencies, which allow for physically smaller LC filter components to reduce the PCB footprint.

**Jitter and FB Ramp Slope**

Figure 4 and Figure 5 show jitter occurring in both PWM mode and skip mode. When there is noise on the V<sub>FB</sub> descending slope, the HS-FET ON time deviates from its intended appoint, introducing jitter that influences the system's stability. The V<sub>FB</sub> ripple's slope steepness dominates the noise immunity though its magnitude has no direct effect.

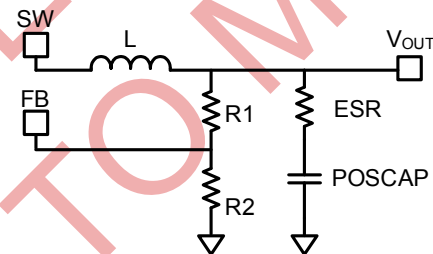


**Figure 4: PWM-Mode Jitter**



**Figure 5: Skip-Mode Jitter Ramp with a Large ESR Capacitor**

Using POSCAPs or other large-ESR capacitors as the output capacitor results in the ESR ripple dominating the output ripple. The ESR also significantly influences the V<sub>FB</sub> slope. Figure 6 shows the simplified equivalent circuit in PWM mode with the HS-FET OFF and without an external ramp circuit.



**Figure 6: Simplified PWM-Mode Circuit without External Ramp Compensation**

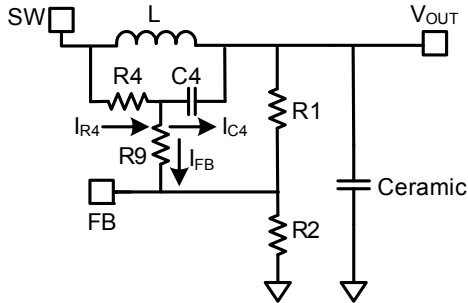
To realize the stability without an external ramp, select the ESR value as follows:

$$R_{ESR} \geq \frac{\tau_{SW} + \tau_{ON}}{0.7 \times \pi \times \frac{2}{C_{OUT}}} \tag{4}$$

Where  $\tau_{SW}$  is the switching period.

**Ramp with a Small ESR Capacitor**

Use an external ramp when using ceramic output capacitors, because the ESR ripple is not high enough to stabilize the system.



**Figure 7: Simplified PWM-Mode Circuit with External Ramp Compensation**

Figure 7 shows the simplified circuit in PWM mode with the HS-FET OFF and an external ramp compensation circuit (R4, C4). Design the external ramp based on the inductor ripple current. Select C4, R9, R1 and R2 to meet the following condition:

$$\frac{1}{2\pi \times f_{SW} \times C4} < \frac{1}{5} \times \left( \frac{R1 \times R2}{R1 + R2} + R9 \right) \quad (5)$$

Where:

$$I_{R4} = I_{C4} + I_{FB} \approx I_{C4} \quad (6)$$

Then estimate the ramp on V<sub>FB</sub> as:

$$V_{RAMP} = \frac{V_{IN} - V_{OUT}}{R4 \times C4} \times \tau_{ON} \times \left( \frac{R1 // R2}{R1 // R2 + R9} \right) \quad (7)$$

The V<sub>FB</sub> ripple's descending slope is then:

$$V_{SLOPE1} = \frac{V_{RAMP}}{\tau_{OFF}} = \frac{-V_{OUT}}{R4 \times C4} \quad (8)$$

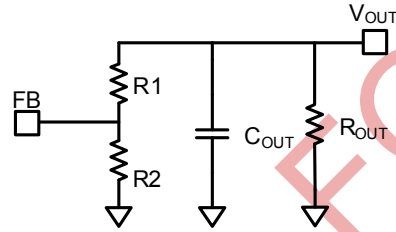
Equation 8 shows that if there is instability in PWM mode, reduce either R4 or C4. If C4 is irreducible due to limitations from equation 5, then reduce R4. For stable PWM operation, design V<sub>slope1</sub> based on equation 9.

$$-V_{SLOPE1} \geq \frac{\frac{T_{SW}}{0.7 \times \pi} + \frac{T_{ON}}{2} - R_{ESR} \times C_{OUT}}{2 \times L \times C_{OUT}} \times V_{OUT} + \frac{I_{OUT} \times 10^{-3}}{T_{SW} - T_{ON}} \quad (9)$$

Where I<sub>OUT</sub> is the load current.

In skip mode, the V<sub>FB</sub> ripple's descending slope is almost the same whether the external ramp is used or not. Figure 8 shows the simplified circuit

in skip mode when both the HS-FET and LS-FET are off.



**Figure 8: Simplified Skip-Mode Circuit**

Determine the V<sub>FB</sub> ripple's descending slope in skip mode as follows:

$$V_{SLOPE2} = \frac{-V_{REF}}{[(R1 + R2) // R_{OUT}] \times C_{OUT}} \quad (10)$$

Where R<sub>OUT</sub> is the equivalent load resistor.

Figures 5 shows that V<sub>SLOPE2</sub> in skip mode is lower than it is in PWM mode, so it is reasonable that the jitter in skip mode is larger. To achieve less jitter during ultra-light-load conditions, reduce R1 and R2, though that will decrease the light-load efficiency.

**Configuring the EN Control**

The regulator turns on when EN goes HIGH. Conversely it turns OFF when EN goes LOW. Do not float the pin.

For automatic start-up, pull the EN pin up to the input voltage through a resistive voltage divider. Choose the values of the pull-up resistor (R<sub>UP</sub>, from the IN pin to the EN pin) and the pull-down resistor (R<sub>DOWN</sub>, from the EN pin to GND) to determine the automatic start-up voltage:

$$V_{IN-START} = 1.5 \times \frac{(R_{UP} + R_{DOWN})}{R_{DOWN}} (V) \quad (11)$$

For example, for R<sub>UP</sub>=100kΩ and R<sub>DOWN</sub>=20kΩ, the V<sub>IN-START</sub> is set at 9V.

To reduce noise, add a 10nF ceramic capacitor from EN to GND.

An internal zener diode on the EN pin clamps the EN pin voltage to prevent runaway. The maximum pull-up current (assuming the worst case, 6V) for the internal zener clamp should be less than 1mA.

Therefore, when driving EN with an external logic signal, use an EN voltage less than 6V; when connecting EN to IN through a pull-up resistor or a resistive voltage divider, select a resistance that ensures a maximum pull up current less than 1mA.

If using a resistive voltage divider and  $V_{IN}$  exceeds 6V, then the minimum resistance for the pull-up resistor  $R_{UP}$  should meet:

$$\frac{V_{IN} - 6V}{R_{UP}} - \frac{6V}{R_{DOWN}} \leq 1mA \quad (12)$$

With only  $R_{UP}$  (the pull-down resistor  $R_{DOWN}$  is not connected), then the VCC UVLO threshold determines  $V_{IN-START}$  so the minimum resistor value is:

$$R_{UP} \geq \frac{V_{IN} - 6V}{1mA} (\Omega) \quad (13)$$

A typical pull-up resistor is 100k $\Omega$ .

#### External VCC bias

An external 5V VCC bias can disable the internal LDO, in this case,  $V_{in}$  can be as low as 2.5V.

#### Soft-Start

The MP8763 employs soft-start (SS) to ensure a smooth output during power-up. When the EN pin goes HIGH, an internal current source (20 $\mu$ A) charges the SS capacitor. The SS capacitor voltage takes over the REF voltage to the PWM comparator. The output voltage smoothly ramps up with the SS voltage. It continues ramping up while  $V_{REF}$  takes over the PWM comparator. At this point, soft-start finishes and the device enters steady state operation.

Determine the SS capacitor value as follows:

$$C_{SS} (\text{nF}) = \frac{T_{SS} (\text{ms}) \times I_{SS} (\mu\text{A})}{V_{REF} (\text{V})} \quad (14)$$

If the output capacitors are large, then avoid setting a short SS time otherwise it would risk hitting the current limit during SS.

#### Pre-Bias Startup

The MP8763 is designed for monotonic startup for pre-biased loads. If the output is pre-biased to a certain voltage during startup, the IC will disable switching for both high-side and low-side switches until the voltage on the soft-start

capacitor exceeds the sensed output voltage at the FB pin.

#### Power Good (PG)

The MP8763 has a power-good (PG) output. The PG pin is the open drain of a MOSFET. Connect it to VCC or some other voltage source that measures less than 5.5V through a pull-up resistor (typically 100k $\Omega$ ). After applying the input voltage, the MOSFET turns ON so that the PG pin is pulled to GND before the SS is ready. After the FB voltage reaches 91% of the REF voltage, the PG pin is pulled HIGH after a 2.5ms delay.

When the FB voltage drops to 80% of the REF voltage or exceeds 120% of the nominal REF voltage, the PG pin is pulled LOW.

If the input supply fails to power the MP8763, the PG pin is also pulled low even though this pin is tied to an external DC source through a pull-up resistor (typically, 100k $\Omega$ ).

#### Over-Current Protection (OCP)

The MP8763 features two current limit levels for over-current conditions: low-side valley current limit and low-side negative current limit.

**Low-Side Valley Current Limit:** The device monitors the inductor current during LS-FET ON state. At the end of LS-FET ON time, the LS-FET sourcing current is compared to the internal positive-valley-current limit. If the valley current limit is less than LS-FET sourcing current, the HS-FET remains OFF and LS-FET remains ON. When LS-FET sourcing current drops below the valley current limit, the LS-FET turns OFF and the HS-FET turns ON for a fixed time determined by frequency-set resistor  $R_{FREQ}$  and input voltage.

During OCP, the device tries to recover from the over-current fault with hiccup mode: the chip disables the output power stage, discharges the soft-start capacitor and then automatically retries soft-start. If the over-current condition still holds after soft-start ends, the device repeats this operation cycle until the over-current conditions disappear and then output rises back to regulation level. OCP offers non-latch protection.

**Low-Side Negative Current Limit:** If the sensed LS-FET negative current exceeds the negative current limit, the LS-FET turns OFF immediately and stays OFF for the remainder for the OFF period. In this situation, both MOSFETs are OFF until the end of a fixed interval. The HS-FET body diode conducts the inductor current for the fixed time.

### Over-Voltage Protection (OVP)

The MP8763 monitors the output voltage using the FB pin connected to the tap of a resistor divider.

If the FB voltage exceeds the nominal REF voltage but remains below 120% of the REF voltage (0.611V), both MOSFETs are OFF.

If the FB voltage exceeds 120% of the REF voltage but remains below 130%, the LS-FET turns ON while the HS-FET remains OFF. The LS-FET remains ON until the FB voltage drops below 110% of the REF voltage or the low-side negative current limit triggers.

If the FB voltage exceeds 130% of the REF voltage, the device enters a non-latch OFF mode. Once the FB voltage rises to a reasonable value, it will exit OVP and operate normally.

### UVLO protection

The MP8763 has under-voltage lockout (UVLO). When the VCC voltage exceeds the UVLO-rising threshold, the MP8763 powers up. It shuts OFF when the VCC voltage falls below the UVLO falling threshold. This is non-latch protection.

The MP8763 is disabled when the VCC voltage falls below 3.4V. If an application requires a higher UVLO threshold, use the two external resistors connected to the EN pin as shown in Figure 9 to adjust the startup input voltage. For best results, use the enable resistors to set the input voltage falling threshold ( $V_{STOP}$ ) above 4 V. Set the rising threshold ( $V_{START}$ ) to provide enough hysteresis to account for any input supply variations.

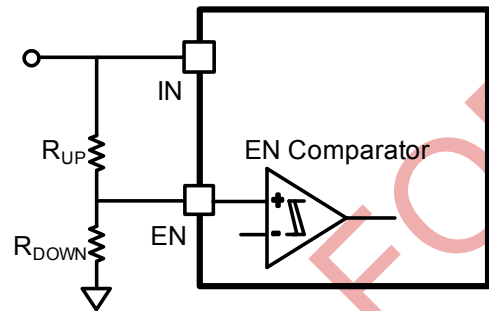


Figure 9: Adjustable UVLO

### Thermal Shutdown

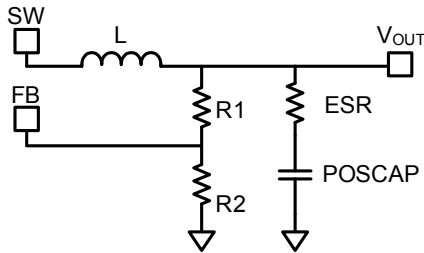
The MP8763 has thermal shutdown. The IC internally monitors the junction temperature. If the junction temperature exceeds the threshold value (minimum 150°C), the converter shuts off. This is a non-latch protection. There is ~25°C hysteresis. Once the junction temperature drops to ~125°C, it initiates a soft-start.



**APPLICATION INFORMATION**

**Output-Voltage, Large-ESR Capacitors**

For applications that use electrolytic or POS capacitors with large ESR values as output capacitors, the feedback resistors—R1 and R2 as shown in Figure 10—set the output voltage.



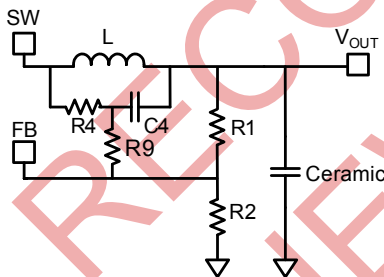
**Figure 10: Simplified POSCAP Circuit**

First, choose an R2 that balances between high quiescent current loss (lower R2) and high noise sensitive on FB (higher R2). A typical value falls within 5kΩ-50kΩ, using a comparatively larger R2 when V<sub>OUT</sub> is low, and a smaller R2 when V<sub>OUT</sub> is high. Then calculate R1 as follows:

$$R1 = \frac{V_{OUT} - \frac{1}{2} \times \Delta V_{OUT} - V_{REF}}{V_{REF}} \times R2 \quad (15)$$

Where ΔV<sub>OUT</sub> is the output ripple determined by equation 24.

**Output-Voltage, Small-ESR Capacitors**



**Figure 11: Simplified Ceramic Capacitor Circuit**

When using a low-ESR, ceramic capacitor on the output, add an external voltage ramp to the FB pin (R4 and C4). The ramp voltage (V<sub>RAMP</sub>) and the resistor divider (shown in Figure 11) influence the output voltage. Calculate V<sub>RAMP</sub> as shown in equation 7. Select R2 to balance between high quiescent current loss and FB noise sensitivity. Choose R2 within 5kΩ-50kΩ, using a larger R2 when V<sub>OUT</sub> is low, and a smaller R2 when V<sub>OUT</sub> is high. Determine the value of R1 as follows:

$$R1 = \frac{R2}{\frac{V_{FB(AVG)}}{V_{OUT} - V_{FB(AVG)}} - \frac{R2}{R4 + R9}} \quad (16)$$

Where V<sub>FB(AVG)</sub> is the average FB voltage. V<sub>FB(AVG)</sub> varies with the V<sub>IN</sub>, V<sub>OUT</sub>, and load condition, where the load regulation is strictly related to the V<sub>FB(AVG)</sub>. Also the line regulation is related to the V<sub>FB(AVG)</sub>—improving load or line regulation involves a lower V<sub>RAMP</sub> that meets equation 9.

For PWM operation, estimate V<sub>FB(AVG)</sub> from equation 17.

$$V_{FB(AVG)} = V_{REF} + \frac{1}{2} \times V_{RAMP} \quad (17)$$

Usually, R9 is 0Ω, though it can also be set following equation 18 for better noise immunity. It should also be less than 20% of R1//R2 to minimize its influence on V<sub>RAMP</sub>.

$$R9 < \frac{1}{5} \times \frac{R1 \times R2}{R1 + R2} \quad (18)$$

Using equations 16 and 17 to calculate the output voltage can be complicated. To simplify the R1 calculation in equation 16, add a DC-blocking capacitor (C<sub>DC</sub>) to filter the DC influence from R4 and R9. Figure 12 shows a simplified circuit with external ramp compensation and a DC-blocking capacitor. The addition of this capacitor simplifies the R1 calculation as per equation 19 for PWM mode operation.

$$R1 = \frac{V_{OUT} - V_{REF} - \frac{1}{2} \times V_{RAMP}}{V_{REF} + \frac{1}{2} \times V_{RAMP}} \times R2 \quad (19)$$

For best results, select a C<sub>DC</sub> value at least 10×C4 for better DC blocking performance, but smaller than 0.47μF to account for start-up performance. To use a larger C<sub>DC</sub> for better FB noise immunity, reduce R1 and R2 to limit their effects on system start-up. Note that even with C<sub>DC</sub>, the load and line regulation are still related to V<sub>RAMP</sub>.

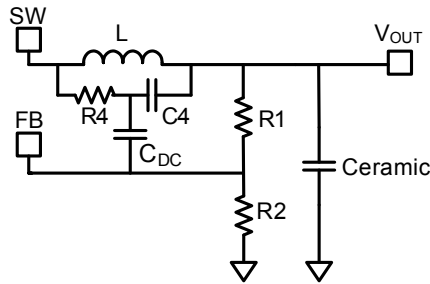


Figure 12: Simplified Ceramic Capacitor Circuit with DC-Blocking Capacitor

**Input Capacitor**

The input current to the step-down converter is discontinuous, and therefore, requires a capacitor to supply the AC current to the step-down converter while maintaining the DC-input voltage. Use ceramic capacitors for best performance. During layout, place the input capacitors as close to the IN pin as possible.

The capacitance can vary significantly with temperature. Use capacitors with X5R and X7R ceramic dielectrics because they are fairly stable over a wide temperature range.

The capacitors must also have a ripple-current rating that exceeds the converter's maximum input ripple current. Estimate the input ripple current as follows:

$$I_{CIN} = I_{OUT} \times \sqrt{\frac{V_{OUT}}{V_{IN}} \times (1 - \frac{V_{OUT}}{V_{IN}})} \quad (20)$$

The worst-case condition occurs at  $V_{IN} = 2V_{OUT}$ , where:

$$I_{CIN} = \frac{I_{OUT}}{2} \quad (21)$$

For simplification, choose an input capacitor with an RMS current rating that exceeds half the maximum load current.

The input capacitance value determines the converter input voltage ripple. Select a capacitor value that meets the input voltage ripple requirement

Estimate the input voltage ripple as follows:

$$\Delta V_{IN} = \frac{I_{OUT}}{f_{SW} \times C_{IN}} \times \frac{V_{OUT}}{V_{IN}} \times (1 - \frac{V_{OUT}}{V_{IN}}) \quad (22)$$

The worst-case condition occurs at  $V_{IN} = 2V_{OUT}$ ,

where:

$$\Delta V_{IN} = \frac{1}{4} \times \frac{I_{OUT}}{f_{SW} \times C_{IN}} \quad (23)$$

**Output Capacitor**

The output capacitor maintains the DC output voltage. Use ceramic capacitors or POSCAPs. Estimate the output voltage ripple as:

$$\Delta V_{OUT} = \frac{V_{OUT}}{f_{SW} \times L} \times (1 - \frac{V_{OUT}}{V_{IN}}) \times (R_{ESR} + \frac{1}{8 \times f_{SW} \times C_{OUT}}) \quad (24)$$

When using ceramic capacitors, the capacitance dominates the impedance at the switching frequency. The capacitance also dominates the output voltage ripple. For simplification, estimate the output voltage ripple as:

$$\Delta V_{OUT} = \frac{V_{OUT}}{8 \times f_{SW}^2 \times L \times C_{OUT}} \times (1 - \frac{V_{OUT}}{V_{IN}}) \quad (25)$$

The ESR contributes minimally to the output voltage ripple, thus requiring an external ramp to stabilize the system. Design the external ramp with R4 and C4 as per equations 5, 8, and 9.

The ESR dominates the switching-frequency impedance for POSCAPs. The ESR ramp voltage is high enough to stabilize the system thus eliminating the need for an external ramp. Select a minimum ESR value of ~12mΩ to ensure stable operation. For simplification, the output ripple can be approximated as:

$$\Delta V_{OUT} = \frac{V_{OUT}}{f_{SW} \times L} \times (1 - \frac{V_{OUT}}{V_{IN}}) \times R_{ESR} \quad (26)$$

**Inductor**

The inductor supplies constant current to the output load while being driven by the switching input voltage. A larger value inductor results in less ripple current and lower output ripple voltage, but is physically larger, has a higher series resistance, and often a lower saturation current. Generally, select an inductor value that allows the inductor peak-to-peak ripple current that is 30% to 40% of the maximum switch current limit. Also, design for a peak inductor current that is

below the maximum switch-current limit. Calculate the inductance value as:

$$L = \frac{V_{OUT}}{f_{SW} \times \Delta I_L} \times \left(1 - \frac{V_{OUT}}{V_{IN}}\right) \quad (27)$$

Where  $\Delta I_L$  is the peak-to-peak inductor ripple current.

Choose an inductor that will not saturate under the maximum inductor peak current. The peak inductor current can be calculated as:

$$I_{LP} = I_{OUT} + \frac{V_{OUT}}{2 \times f_{SW} \times L} \times \left(1 - \frac{V_{OUT}}{V_{IN}}\right) \quad (28)$$

Table 1 lists a few highly-recommended high-efficiency inductors.

**Table 1: Inductor Selection Guide**

Part Number	Manufacturer	Inductance ( $\mu\text{H}$ )	DCR (m $\Omega$ )	Current Rating (A)	Dimensions L x W x H (mm <sup>3</sup> )	Switching Frequency (kHz)
744325072	Würth	0.72	1.35	35	10.2 x 10.5 x 4.7	500
FDA1055-1R5M	TOKO	1.5	2.8	24	10.6 x 10.8 x 5.5	500
744325180	Würth	1.8	3.5	18	10.2 x 10.5 x 4.7	500

**Typical Design Parameters**

Tables 2 and 3 list recommended component values for typical output voltages (1V, 2.5V, 3.3V) and switching frequency (500kHz). Refer to Table 2 for design cases without external ramp compensation and Table 3 for design cases with external ramp compensation. An external ramp is not needed when using high-ESR capacitors, such as electrolytics or POSCAPs. Use an external ramp when using low-ESR capacitors, such as ceramic capacitors. For cases not listed in this datasheet, contact a local sales representative for an Excel spreadsheet to assist with the calculation.

**Table 2—MP8763,  $F_{SW}=500\text{kHz}$ ,  $V_{IN}=12\text{V}$**

V <sub>OUT</sub> (V)	L ( $\mu\text{H}$ )	R1 (k $\Omega$ )	R2 (k $\Omega$ )	R7 <sup>(8)</sup> (k $\Omega$ )
1	0.72	12.7	20	357
2.5	1.5	61.9	20	825
3.3	1.8	88.7	20	1083

**Table 3—MP8763,  $F_{SW}=500\text{kHz}$ ,  $V_{IN}=12\text{V}$**

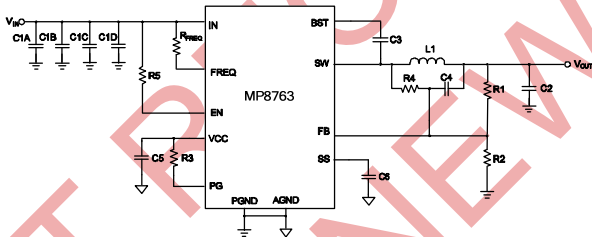
V <sub>OUT</sub> (V)	L ( $\mu\text{H}$ )	R1 (k $\Omega$ )	R2 (k $\Omega$ )	R4 (k $\Omega$ )	C4 (pF)	R7 <sup>(8)</sup> (k $\Omega$ )
1	0.72	12.7	20	750	220	357
2.5	1.5	64.9	20	1000	220	825
3.3	1.8	93.1	20	1200	220	1083

**Notes:**

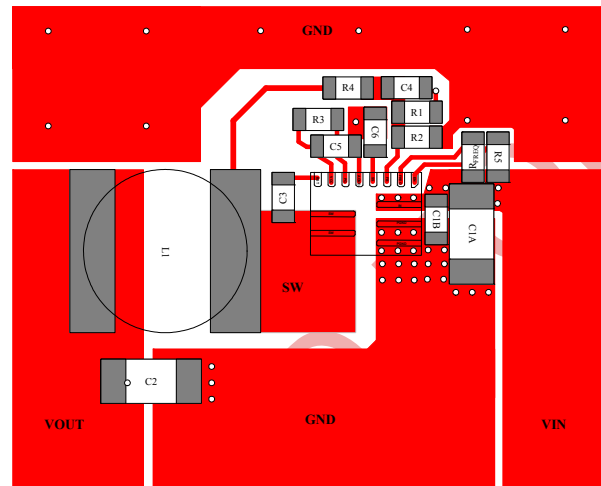
8) Frequency is about 500kHz at full load condition in test. RFREQ is a little different from equation (3) due to the voltage drop on MOSFET.

## LAYOUT RECOMMENDATIONS

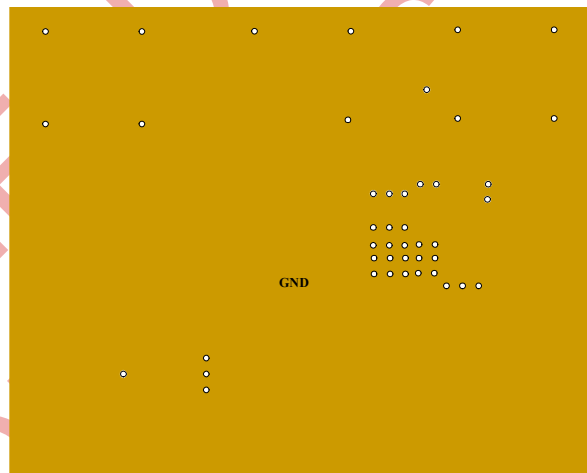
1. MPS offers two packages, but recommends MP8763GLE with its 16-pin QFN package for all new designs due to its smaller parasitical inductance.
2. Place high current paths (GND, IN, and SW) very close to the device with short, direct and wide traces.
3. The 13-pin QFN package requires two copper IN layers for better performance. Respectively put at least one decoupling capacitor on both Top and Bottom layers and as close to the IN and GND pins as possible. Add several vias with 18mil and 8mil hole diameters under the device and near the input capacitors to help dissipate heat and to reduce parasitic inductances.
4. Place a decoupling capacitor as close to the VCC and AGND pins as possible.
5. Keep the switching node (SW) plane as small as possible and far away from the feedback network.
6. Place the external feedback resistors next to the FB pin. Make sure that there are no vias on the FB trace. The feedback resistors should refer to AGND instead of PGND.
7. Keep the BST voltage path (BST, C3, and SW) as short as possible.
8. MPS strongly recommends a four-layer layout to improve thermal performance.



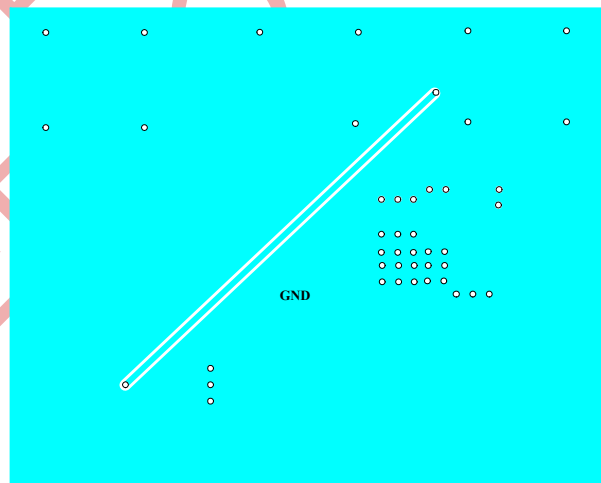
**Figure 13: Schematic Reference for PCB Layout**



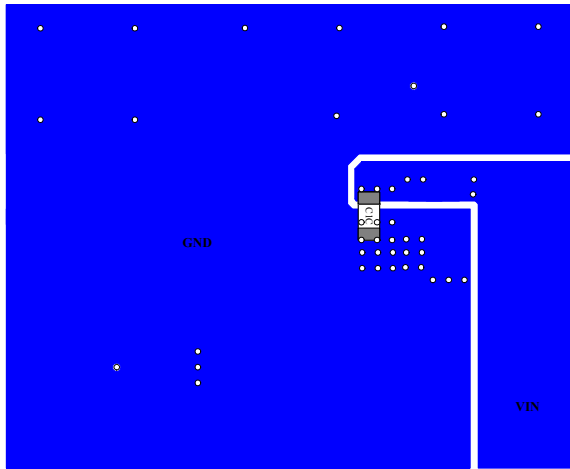
**Top Layer**



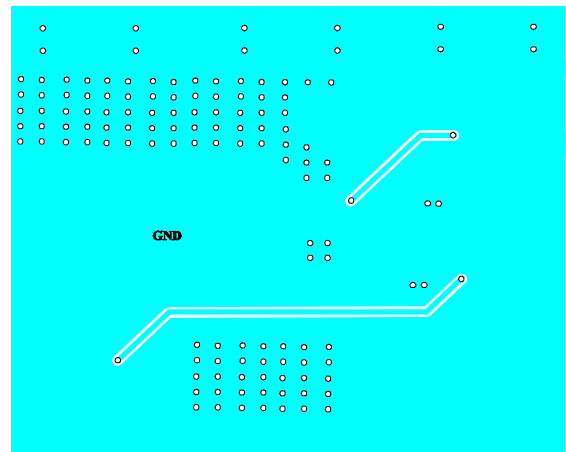
**Inner1 Layer**



**Inner2 Layer**

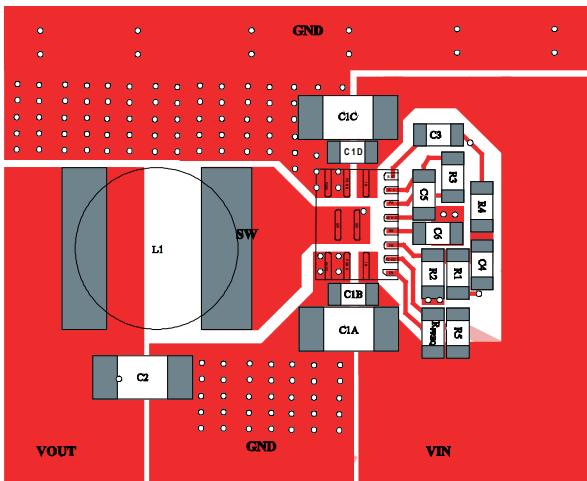


Bottom Layer

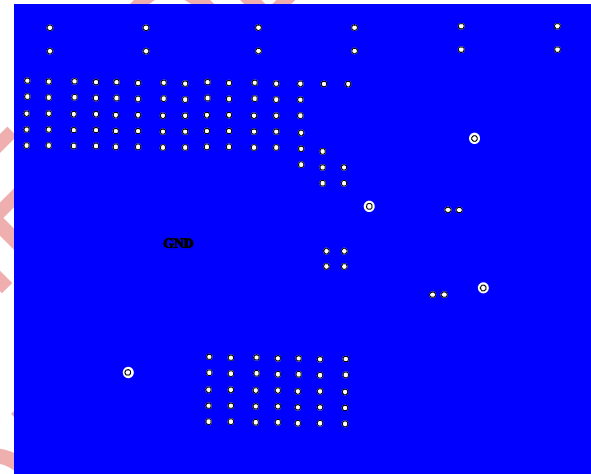


Inner2 Layer

Figure 14: 13-Pin QFN MP8763 PCB Layout Guide



Top Layer



Bottom Layer

Figure 15: PCB Layout Guide for MP8763GLE (16-Pin QFN)

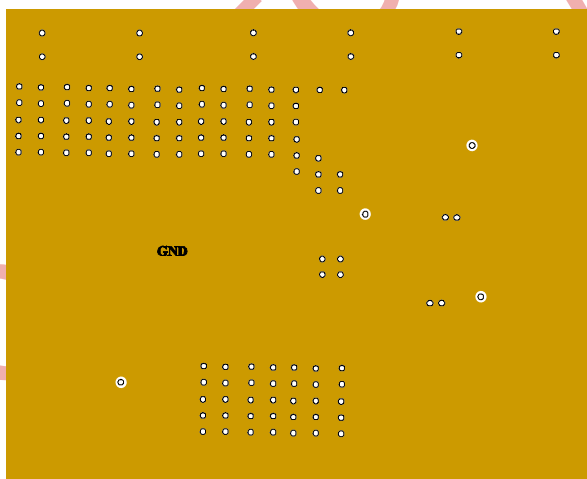
### Design Example

Table 4 lists the specifications for a design example that follows the application guidelines:

Table 4: Design Example

$V_{IN}$	12V
$V_{OUT}$	1V
$F_{SW}$	500kHz

The detailed application schematic is shown in Figure 16. The typical performance and circuit waveforms have been shown in the Typical Performance Characteristics section. For more device applications, please refer to the related Evaluation Board Datasheet.



Inner1 Layer

TYPICAL APPLICATION

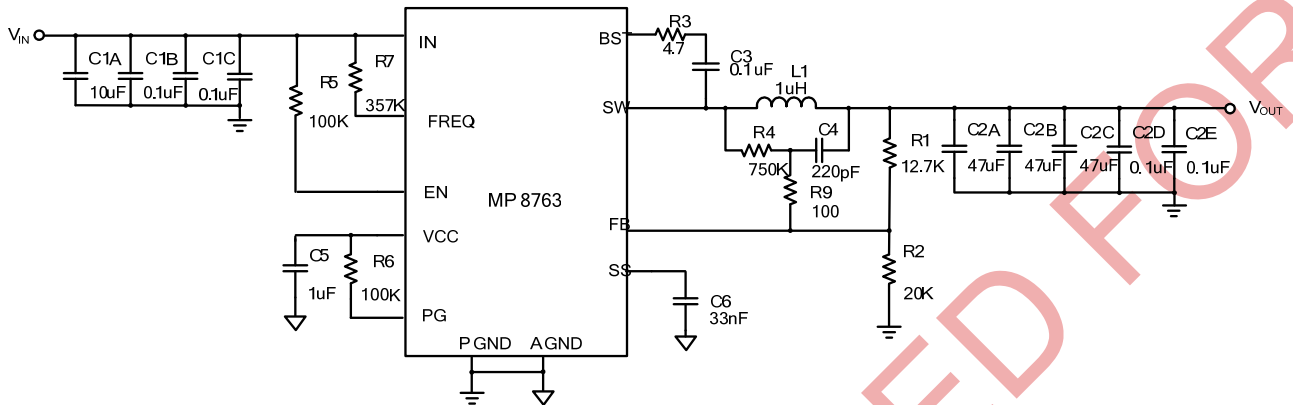
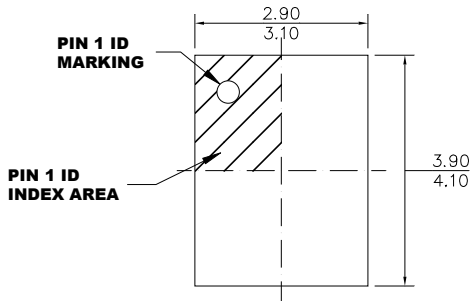


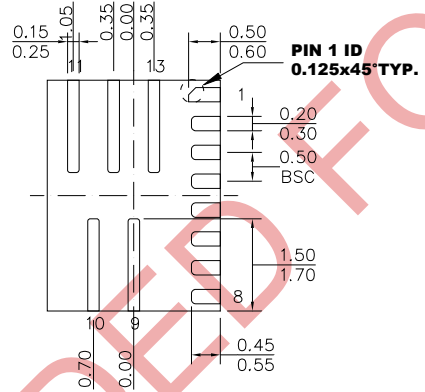
Figure 16: Typical Application Circuit with Low ESR Ceramic Capacitor for 1V Output

PACKAGE INFORMATION

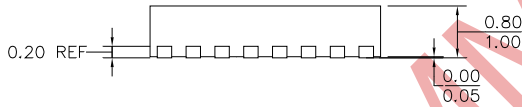
QFN-13 (3mm×4mm)



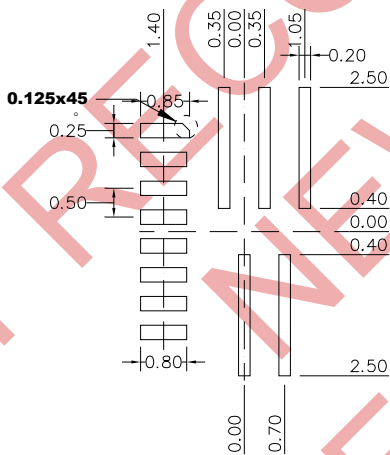
TOP VIEW



BOTTOM VIEW



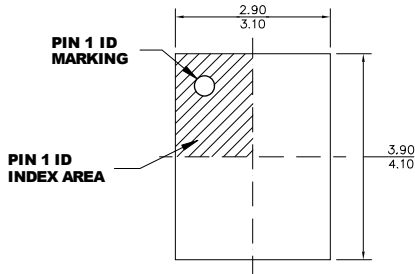
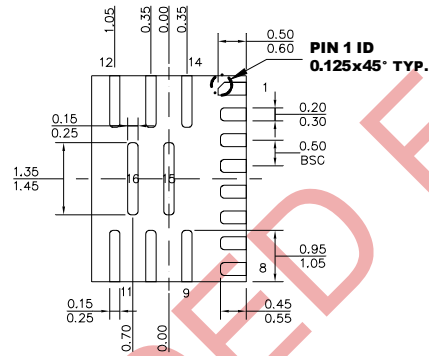
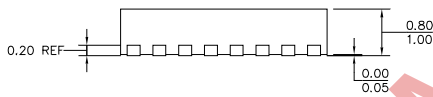
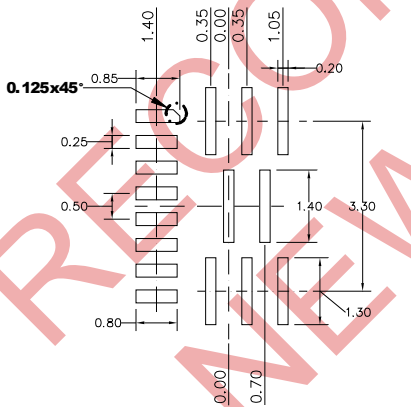
SIDE VIEW



RECOMMENDED LAND PATTERN

**NOTE:**

- 1) ALL DIMENSIONS ARE IN MILLIMETERS.
- 2) EXPOSED PADDLE SIZE DOES NOT INCLUDE MOLD FLASH.
- 3) LEAD COPLANARITY SHALL BE 0.10 MILLIMETERS MAX.
- 4) JEDEC REFERENCE IS MO-220.
- 5) DRAWING IS NOT TO SCALE.

**PACKAGE INFORMATION**
**QFN-16 (3mm×4mm)**

**TOP VIEW**

**BOTTOM VIEW**

**SIDE VIEW**

**RECOMMENDED LAND PATTERN**
**NOTE:**

- 1) ALL DIMENSIONS ARE IN MILLIMETERS
- 2) EXPOSED PADDLE SIZE DOES NOT INCLUDE MOLD FLASH.
- 3) LEAD COPLANARITY SHALL BE 0.10 MILLIMETERS MAX
- 4) JEDEC REFERENCE IS MQ220.
- 5) DRAWING IS NOT TO SCALE

**NOTICE:** The information in this document is subject to change without notice. Users should warrant and guarantee that third party Intellectual Property rights are not infringed upon when integrating MPS products into any application. MPS will not assume any legal responsibility for any said applications.