

## DESCRIPTION

The MP20049 is an ultra-low noise, low-dropout, high PSRR linear regulator. Fixed output voltage options are available between 1.2V to 4.5V with 1% accuracy while operating from a +2.3V to +6V input. It is designed to deliver up to 150mA of load current. Dropout voltage is only 60mV at full load.

The MP20049 uses an internal PMOS as the pass element, which consumes 50 $\mu$ A supply current at no load condition and is suitable for battery-power devices. New innovative design techniques enable the MP20049 to achieve ultra-low output voltage noise of only 16 $\mu$ V<sub>RMS</sub> without a noise bypass capacitor.

The MP20049 is designed and optimized to work with low value, low cost ceramic capacitors. It typically requires only 1 $\mu$ F of output capacitance for stability with any load.

The MP20049 features current limit and over temperature protection and is available in a tiny 4-ball 0.8x0.8mm WLCSP package.

## FEATURES

- Linear Regulator in 0.8x0.8mm WLCSP
- Input Voltage Range: 2.3V to 6V
- Up to 150mA Output Current
- 16 $\mu$ V<sub>RMS</sub> Output Noise (100Hz to 100kHz) with No Bypass Capacitor required
- High PSRR:
  - 78dB @1kHz
  - 55dB @100kHz
- Low Dropout:
  - 50mV @120mA Load
  - 60mV @150mA Load
- Stable with 1 $\mu$ F Ceramic Capacitor for Any Load
- Very Fast Line/Load Transient Response
- Current Limit and Thermal Protection

## APPLICATIONS

- Cellular Mobile Phones
- Digital Cameras
- Handheld and Battery-powered Equipment
- Wireless LAN
- Post DC-to-DC Regulation

All MPS parts are lead-free and adhere to the RoHS directive. For MPS green status, please visit [MPS website](#) under Products, Quality Assurance page.  
"MPS" and "The Future of Analog IC Technology" are registered trademarks of Monolithic Power Systems, Inc.

## TYPICAL APPLICATION

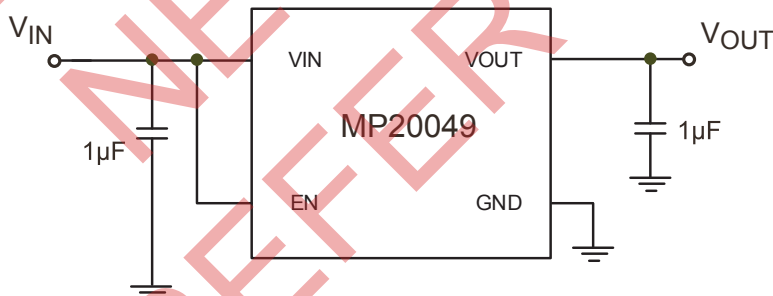

## ORDERING INFORMATION

Part Number*	Package	VOUT(V)	Top Marking	Free Air Temperature (T <sub>A</sub> )
MP20049DC-2.8**	WLCSP (0.8x0.8mm)	2.8	7Z	-40°C to +125°C

\* For Tape & Reel, add suffix -Z (e.g. MP20049DC-Z);  
 For RoHS, compliant packaging, add suffix -LF (e.g. MP20049DC-LF-Z).  
 \*\* Contact factory for other fixed Output Options.

### ORDERING GUIDE\*\*

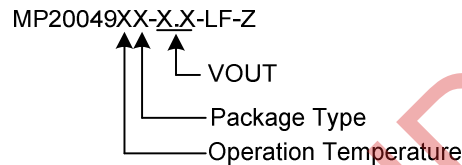

### PACKAGE REFERENCE

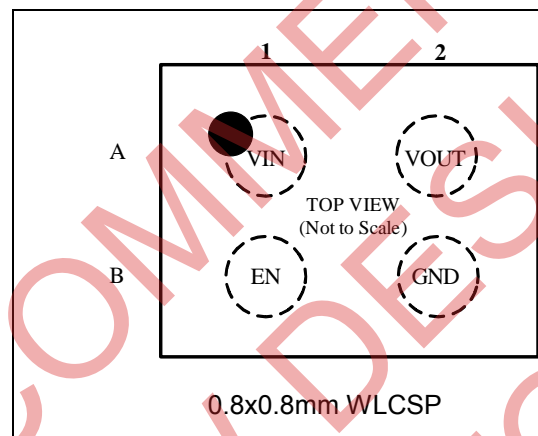

### ABSOLUTE MAXIMUM RATINGS <sup>(1)</sup>

Supply Input Voltage .....	6.5V
Continuous Power Dissipation (T <sub>A</sub> = +25°C) <sup>(2)</sup>	
WLCSP .....	0.37W
Storage Temperature Range ....	-65°C to 150°C
Lead Temperature (Soldering, 10sec) ....	300°C

### ESD SUSCEPTIBILITY <sup>(3)</sup>

HBM (Human Body Mode) .....	2kV
MM (Machine Mode) .....	200V

### Recommended Operating Conditions <sup>(4)</sup>

Supply Input Voltage .....	2.3V to 6.0V
Enable Input Voltage .....	0V to 5.5V
Operating Junct. Temp (T <sub>J</sub> ).....	-40°C to +125°C

Thermal Resistance <sup>(5)</sup>	$\theta_{JA}$	$\theta_{JC}$
WLCSP .....	330	n/a .. °C/W

#### Notes:

- Exceeding these ratings may damage the device.
- The maximum allowable power dissipation is a function of the maximum junction temperature T<sub>J</sub> (MAX), the junction-to-ambient thermal resistance  $\theta_{JA}$ , and the ambient temperature T<sub>A</sub>. The maximum allowable continuous power dissipation at any ambient temperature is calculated by P<sub>D</sub> (MAX) = (T<sub>J</sub> (MAX)-T<sub>A</sub>)/ $\theta_{JA}$ . Exceeding the maximum allowable power dissipation will cause excessive die temperature, and the regulator will go into thermal shutdown. Internal thermal shutdown circuitry protects the device from permanent damage.
- Devices are ESD sensitive. Handling precaution recommended.
- The device is not guaranteed to function outside of its operating conditions.
- Measured on JESD51-7, 4-layer PCB.

## ELECTRICAL CHARACTERISTICS

$V_{IN} = (V_{OUT} + 0.5V)$  or  $2.5V$  (whichever is greater),  $EN = V_{IN}$ ,  $I_{OUT} = 10mA$ ,  $C_{IN} = C_{OUT} = 1\mu F$   
 $T_A = 25^\circ C$ , unless otherwise noted.

Parameter	Symbol	Condition	Min	Typ	Max	Units
Input voltage range	$V_{IN}$		2.3		6	V
Maximum Output Current	$I_{MAX}$	Continuous	150			mA
Output Voltage Accuracy	$\Delta V_{OUT}$	$I_{OUT} = 10mA$	-1		+1	%
Current Limit	$I_{LIM}$	$R_{Load} = 1\Omega$	165	250	380	mA
Ground Current	$I_Q$	No Load( $25^\circ C$ )	40	55	70	$\mu A$
		No Load( $-40^\circ C < T_A < 85^\circ C$ )	40		75	$\mu A$
Dropout Voltage <sup>(6)</sup>	$V_{DROP}$	$V_{OUT} = 2.8V$ , $I_{OUT} = 80mA$ $T_J = -40^\circ C$ to $125^\circ C$		40	110	mV
		$V_{OUT} = 2.8V$ , $I_{OUT} = 120mA$ $T_J = -40^\circ C$ to $125^\circ C$		50	120	mV
Line regulation <sup>(7)</sup>	$V_{LNR}$	$V_{IN} = 3.3V$ to $6V$ $I_{OUT} = 0.1mA$	-0.06		+0.06	%/V
Load regulation <sup>(8)</sup>	$V_{LDR}$	$I_{OUT} = 1mA$ to $150mA$		0.001		%/mA
EN Input High Threshold	$V_{IH}$	$V_{IN} = 3.3V$ to $5.5V$	1.2			V
EN Input Low Threshold	$V_{IL}$	$V_{IN} = 3.3V$ to $5.5V$			0.4	V
EN Input Bias Current	$I_{SD}$	$EN = V_{IN} = 5.5V$		100	300	nA
Shutdown Supply Current	$I_{GSD}$	$EN = GND$		0.03	1	$\mu A$
Thermal Shutdown Temperature	$T_{SD}$			150		$^\circ C$
Thermal Shutdown Hysteresis	$\Delta T_{SD}$			20		$^\circ C$
Output Voltage Noise		10Hz to 100kHz, $C_{OUT} = 4.7\mu F$ , $V_{out} = 1.2V$ $I_{LOAD} = 10mA$		16		$\mu V_{RMS}$
Output Voltage AC PSRR		1kHz, $C_{OUT} = 2.2\mu F$ , $I_{LOAD} = 10mA$		78		dB
		10kHz, $C_{OUT} = 2.2\mu F$ , $I_{LOAD} = 10mA$		75		dB
		100kHz, $C_{OUT} = 2.2\mu F$ , $I_{LOAD} = 10mA$		55		dB

**Notes:**

6) Dropout Voltage is defined as the input to output differential when the output voltage drops 100mV below its nominal value.

$$7) \text{ Line Regulation} = \frac{V_{OUT[V_{IN(MAX)}]} - V_{OUT[V_{IN(MIN)}]}}{[V_{IN(MAX)} - V_{IN(MIN)}] \times V_{OUT(NOM)}} \times (\% / V)$$

$$8) \text{ Load Regulation} = \frac{V_{OUT[I_{OUT(MAX)}]} - V_{OUT[I_{OUT(MIN)}]}}{[I_{OUT(MAX)} - I_{OUT(MIN)}] \times V_{OUT(NOM)}}$$

**PIN FUNCTIONS**

Pin#	Name	Description
A1	VIN	Regulator Input Supply. Bypass VIN to GND with a 1 $\mu$ F or greater capacitor.
B2	GND	Ground Pin.
B1	EN	Enable Input. Drive EN high to turn on the Regulator; drive it low to turn off the Regulator. For automatic startup, connect EN to VIN.
A2	VOUT	Regulated Output Voltage. Connect a 1 $\mu$ F or greater output capacitor between VOUT and GND.

NOT RECOMMENDED FOR  
NEW DESIGNS  
REFER TO MP2000

## TYPICAL PERFORMANCE CHARACTERISTICS

$V_{IN}=3.3V$ ,  $V_{OUT}=2.8V$ ,  $C_{IN}=C_{OUT}=1\mu F$ ,  $T_A=25^\circ C$ , unless otherwise noted

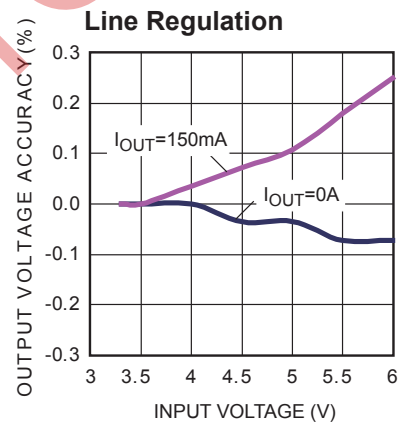
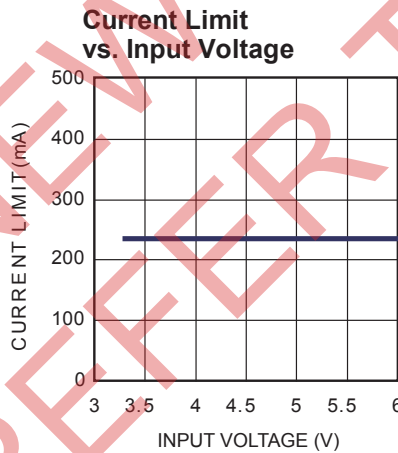
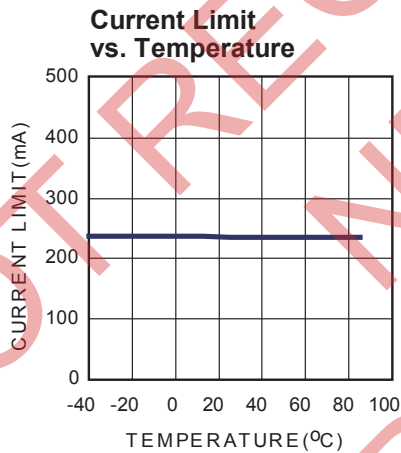
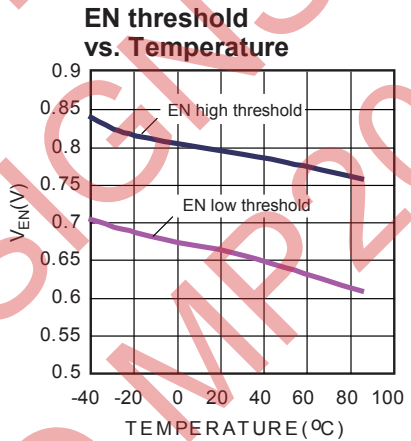
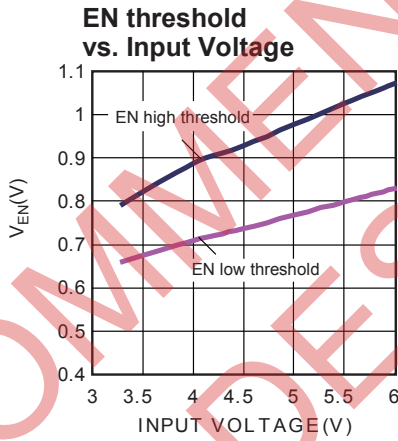
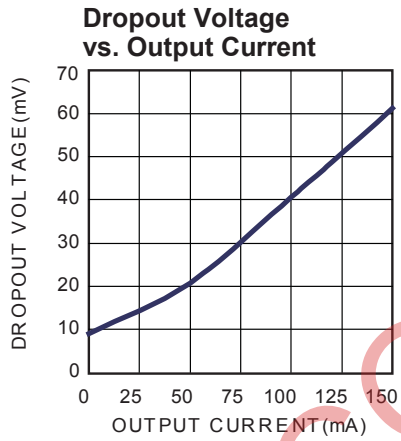
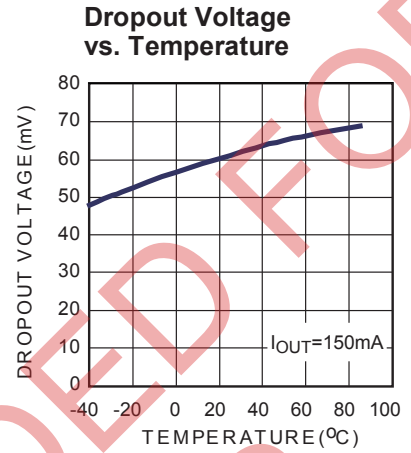
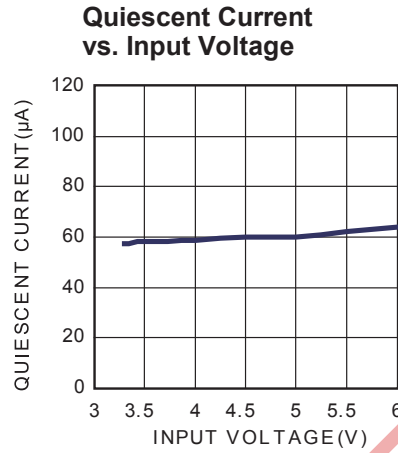
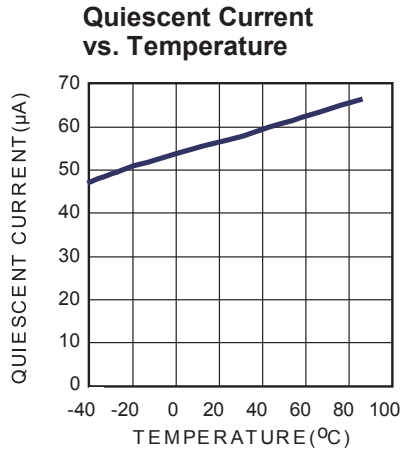

**TYPICAL PERFORMANCE CHARACTERISTICS (continued)**

$V_{IN}=3.3V$ ,  $V_{OUT}=2.8V$ ,  $C_{IN}=C_{OUT}=1\mu F$ ,  $T_A=25^\circ C$ , unless otherwise noted

**Load Regulation**

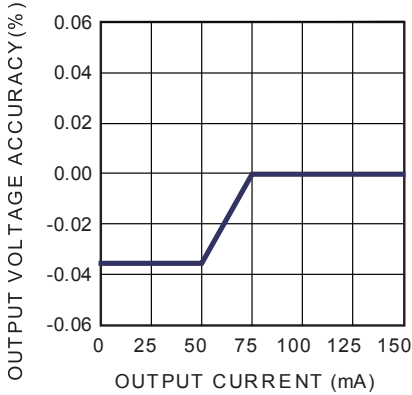

**Output Voltage Accuracy vs. Temperature**

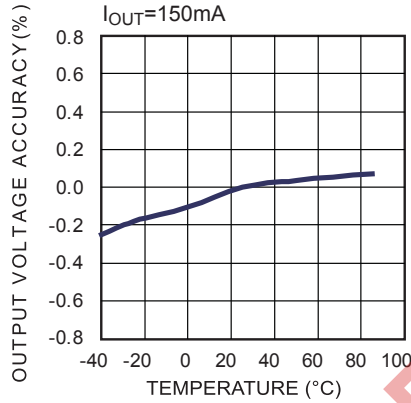

**PSRR**

$I_{OUT}=10mA, 50mA, 100mA, 150mA$   
f ranges from 10Hz to 10MHz

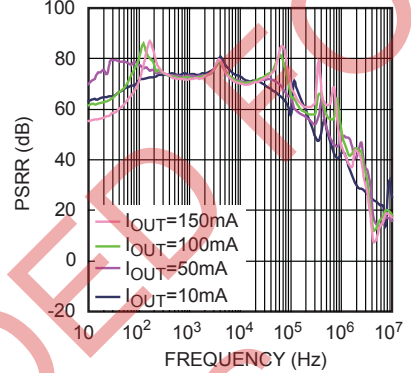

**Region of Stable C<sub>OUT</sub> ESR vs. Output Current**

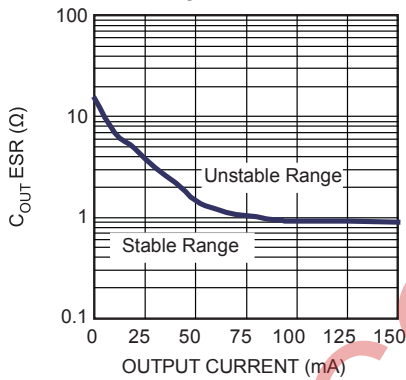

**TYPICAL PERFORMANCE CHARACTERISTICS (continued)**
 $V_{IN}=3.3V$ ,  $V_{OUT}=2.8V$ ,  $C_{IN}=C_{OUT}=1\mu F$ ,  $T_A=25^\circ C$ , unless otherwise noted

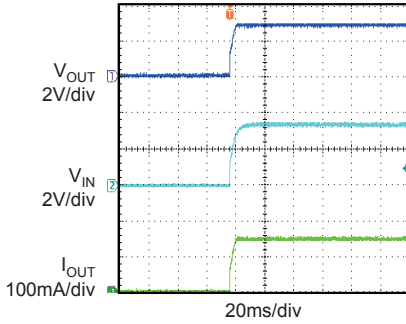
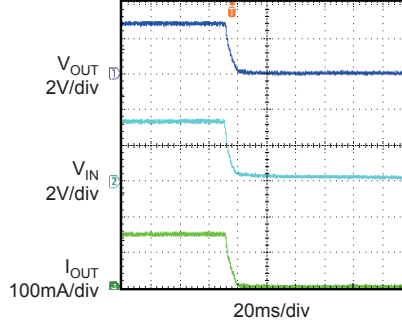
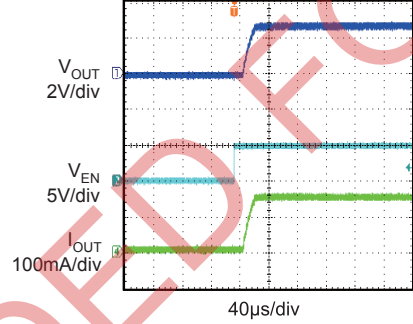
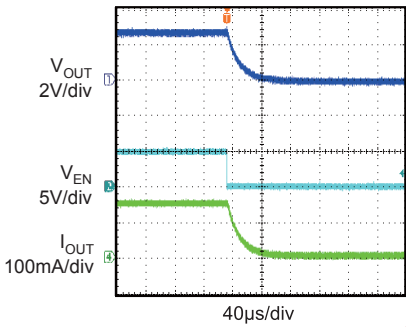
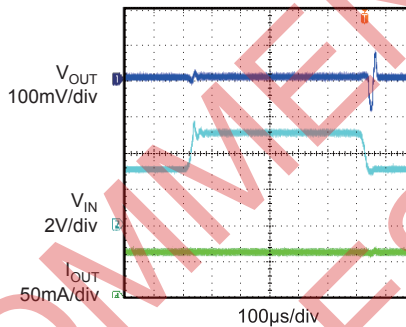
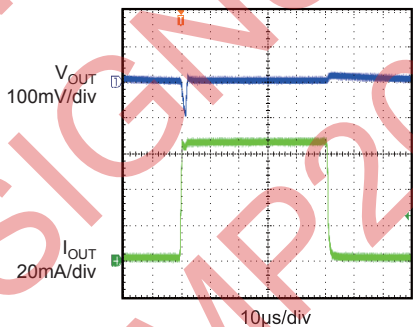
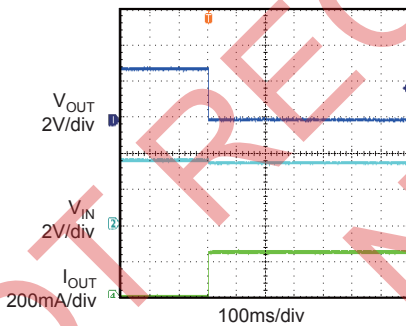
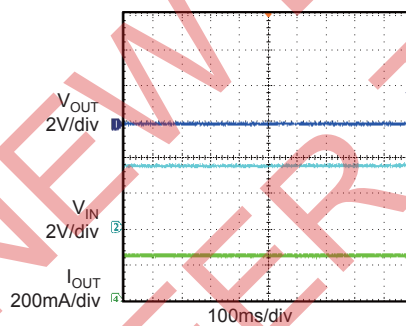
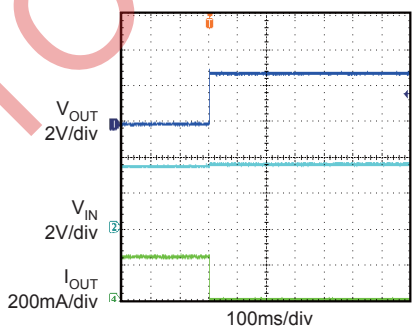
**Input Power Start Up**
 $I_{OUT}=150mA$ , with Resistor Load

**Input Power Shutdown**
 $I_{OUT}=150mA$ , with Resistor Load

**EN Start Up**
 $I_{OUT}=150mA$ , with Resistor Load

**EN Shutdown**
 $I_{OUT}=150mA$ , with Resistor Load

**Line Transient**
 $V_{IN}=2.5V$  to  $5V$ ,  $I_{OUT}=60mA$ , with Resistor Load

**Load Transient**
 $I_{OUT}=1mA$  to  $65mA$ , with Resistor Load

**Over Current Protection Entry**

**Over Current Protection Steady State**

**Over Current Protection Recovery**

## OPERATION

The MP20049 is an ultra low noise, low dropout, low quiescent current and high PSRR linear regulator for space-restricted applications. It is intended for use in devices that require very low voltage, and ultra-small footprint, such as mobile phone and MP3 players.

The MP20049 uses an internal PMOS as the pass elements and features internal thermal shutdown and internal current limit circuits.

### Dropout Voltage

Dropout voltage is the minimum input to output differential voltage required for the regulator to maintain an output voltage within 100mV of its nominal value. It determines the available end-of-life battery voltage in battery-powered systems. For the P-channel MOSFET pass element, the dropout voltage is a function of drain to source on resistance. Because the P-channel MOSFET pass element behaves as a low-value resistor, the dropout voltage of MP20049 is very low.

### Under Voltage Lockout

The MP20049 has an internal under-voltage lockout circuit that disables the device when the input voltage is less than approximately 2.3V. This ensures that the input and the output of the

MP20049 behave in a predictable manner during input power-up.

### Enable ON/Off

The MP20049 can be switched ON or OFF by a logic input at the EN pin. A high voltage at this pin will turn the device on. When the EN pin is low, the regulator output is off. The EN pin should be tied to VIN to keep the regulator output always on if the application does not require the shutdown feature.

Do not float the EN pin.

### Current Limit and Thermal Protection

The MP20049 includes an independent current limit structure which monitors and controls the P-channel MOSFET's gate voltage to limit the guaranteed maximum output current to 150mA.

Thermal protection turns off the P-channel MOSFET when the junction temperature exceeds +150°C, allowing the IC to cool. When the IC's junction temperature drops by 20°C, the PMOS will be turned on again. Thermal protection limits total power dissipation in the MP20049. For reliable operation, junction temperature should be limited to 125°C maximum.



## FUNCTIONAL BLOCK DIAGRAM

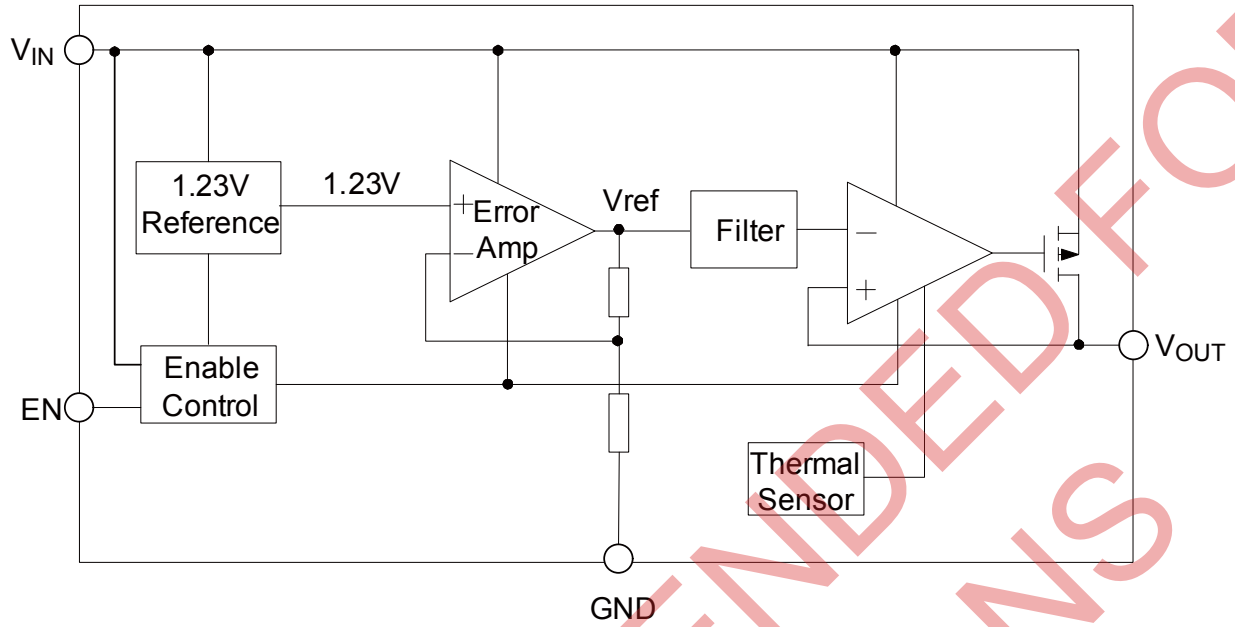

Figure 1—Functional Block Diagram

## APPLICATION INFORMATION

### Power Dissipation

The power dissipation for any package depends on the thermal resistance of the case and circuit board, the temperature difference between the junction and ambient air, and the rate of airflow. The power dissipation across the device can be represented by the equation:

$$P = (V_{IN} - V_{OUT}) \times I_{OUT}$$

The allowable power dissipation can be calculated using the following equation:

$$P_{(MAX)} = (T_{Junction} - T_{Ambient}) / \theta_{JA}$$

Where  $(T_{Junction} - T_{Ambient})$  is the temperature difference between the junction and the surrounding environment,  $\theta_{JA}$  is the thermal resistance from the junction to the ambient environment. Connecting the GND pin of MP20049 to ground with a large ground plane will help the channel heat away.

### Input Capacitor Selection

Using a capacitor whose value is  $>1\mu F$  on the MP20049 input and the amount of capacitance can be increased without limit. Larger values will help to improve line transient response with the drawback of increased size. Ceramic capacitors are preferred, but tantalum capacitors may also suffice.

### Output Capacitor Selection

The MP20049 is designed specifically to work with very low ESR ceramic output capacitor in space-limiting and performance consideration. Output capacitor of larger values will help to improve load transient response and reduce noise with the drawback of increased size. For the application circuit, the MP20049 requires a minimum capacitance of  $0.7\mu F$  with an ESR of  $1\Omega$  or less.

### Output Noise and PSRR

For MP20049, an internal  $50pF$  bypass capacitor with new innovative structure reduces output noises greatly, without the need for an external bypass capacitor. The power supply rejection is  $75dB$  at  $10kHz$  and  $55dB$  at  $100kHz$ .

## PACKAGE INFORMATION

### WLCSP

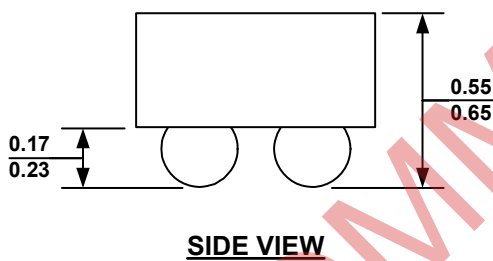
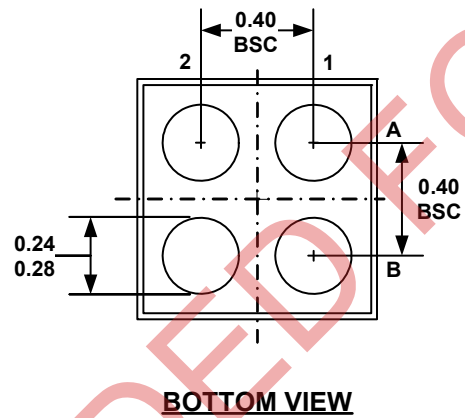
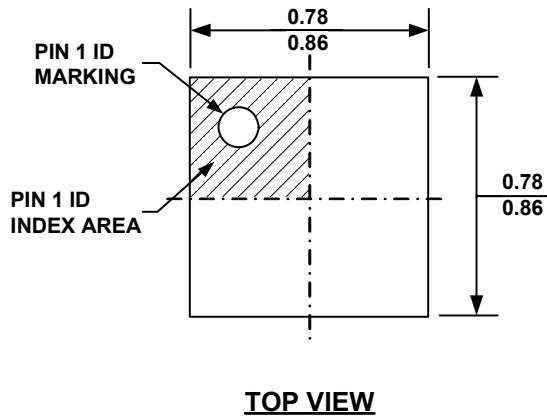

#### NOTE:

- 1) ALL DIMENSIONS ARE IN MILLIMETERS.
- 2) BALL COPLANARITY SHALL BE 0.05 MILLIMETER MAX.
- 3) JEDEC REFERENCE IS MO-211, VARIATION AA.
- 4) DRAWING IS NOT TO SCALE.

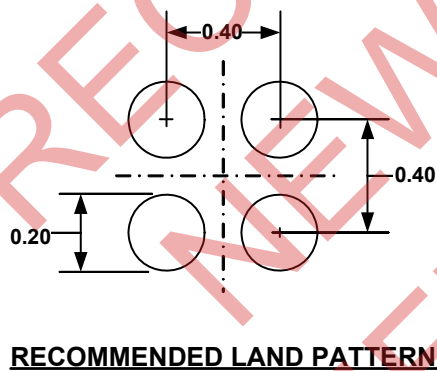

**NOTICE:** The information in this document is subject to change without notice. Please contact MPS for current specifications. Users should warrant and guarantee that third party Intellectual Property rights are not infringed upon when integrating MPS products into any application. MPS will not assume any legal responsibility for any said applications.