

FEATURES

Amplitude settling: 200 ns typical
Wideband rejection: ≥ 20 dB
Single chip implementation
40-lead, 6 mm \times 6 mm, RoHS compliant LFCSP

APPLICATIONS

Test and measurement equipment
Military radar and electronic warfare (EW) systems
Video satellite (VSAT) communications

GENERAL DESCRIPTION

The ADMV8416 is a monolithic microwave integrated circuit (MMIC), tunable band-pass filter that features a user selectable pass-band frequency. The 3 dB filter bandwidth is approximately 15% of the center frequency (f_{CENTER}), and the 20 dB filter bandwidth is 37%. Additionally, f_{CENTER} can be varied between

FUNCTIONAL BLOCK DIAGRAM

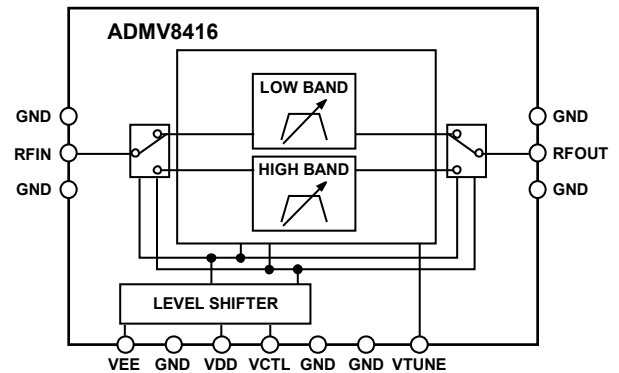

Figure 1.

7 GHz to 16 GHz by applying an analog f_{CENTER} tuning voltage between 0 V to 15 V. This tunable filter can be used as a much smaller alternative to large switched filter banks and cavity tuned filters. The filter has excellent microphonics due to the monolithic design and provides a dynamically adjustable solution.

TABLE OF CONTENTS

Features	1	Interface Schematics	6
Applications.....	1	Typical Performance Characteristics	7
Functional Block Diagram	1	High Band, VCTL = 0 V	7
General Description	1	Low Band, VCTL = 2.5 V	10
Revision History	2	Phase Sensitivity	13
Specifications.....	3	Theory of Operation	14
High Band Specifications	3	Applications Information	15
Low Band Specifications.....	4	Typical Application Circuit.....	15
DC Characteristics	4	Outline Dimensions	16
Absolute Maximum Ratings.....	5	Ordering Guide	16
ESD Caution.....	5		
Pin Configuration and Function Descriptions.....	6		

REVISION HISTORY

7/2019—Revision 0: Initial Version

SPECIFICATIONS

HIGH BAND SPECIFICATIONS

$T_A = 25^\circ\text{C}$, VTUNE is swept from 0 V to 15 V, VDD = 5 V, VEE = -5 V, and VCTL = 0 V, unless otherwise noted.

Table 1.

Parameter	Min	Typ	Max	Unit	Test Conditions/Comments
FREQUENCY RANGE					
f_{CENTER}	12.5		16	GHz	
FILTER BANDWIDTH					
3 dB		16		%	
20 dB		37		%	
WIDEBAND REJECTION					
Low-Side		$0.8 \times f_{\text{CENTER}}$		dB	≥ 20 dB
High-Side		$1.17 \times f_{\text{CENTER}}$		dB	≥ 20 dB
Re-Entry		>40		GHz	≤ 30 dB
LOSS					
Insertion Loss		8		dB	
Return Loss		8.5		dB	
DYNAMIC PERFORMANCE					
Input Third-Order Intercept (IP3)		38		dBm	
Input Power at 5° Shift in Insertion Phase		>20		dBm	VTUNE = 0 V
Group Delay Flatness		0.1		ns	VTUNE = 0 V
Phase Sensitivity		0.7		Rad/V	
Amplitude Settling		200		ns	Time to settle to minimum insertion loss, within ≤ 0.5 dB of static insertion loss
Drift Rate		-2.17		MHz/°C	
Tuning Sensitivity		417		MHz/V	
RESIDUAL PHASE NOISE					
1 MHz Offset		-160		dBc/Hz	

LOW BAND SPECIFICATIONS

T_A = 25°C, VTUNE is swept from 0 V to 15 V, VDD = 5 V, VEE = -5 V, and VCTL = 2.5 V, unless otherwise noted.

Table 2.

Parameter	Min	Typ	Max	Unit	Test Conditions/Comments
FREQUENCY RANGE					
f _{CENTER}	7		12	GHz	
FILTER BANDWIDTH					
3 dB		15		%	
20 dB		37		%	
WIDEBAND REJECTION					
Low-Side		0.8 × f _{CENTER}		dB	≥20 dB
High-Side		1.16 × f _{CENTER}		dB	≥20 dB
Re-Entry		>40		GHz	≤30 dB
LOSS					
Insertion Loss		8		dB	
Return Loss		7.7		dB	
DYNAMIC PERFORMANCE					
Input IP3		34		dBm	VTUNE = 0 V
Input Power at 5° Shift in Insertion Phase		13		dBm	VTUNE = 0 V
Group Delay Flatness		0.20		ns	VTUNE = 0 V
Phase Sensitivity		1.21		Rad/V	
Amplitude Settling		200		ns	Time to settle to minimum insertion loss, within ≤0.5 dB of static insertion loss
Drift Rate		-0.71		MHz/°C	
Tuning Sensitivity		421		MHz/V	
RESIDUAL PHASE NOISE					
1 MHz Offset		-162		dBc/Hz	

DC CHARACTERISTICS**Table 3.**

Parameter	Min	Typ	Max	Unit	Test Conditions/Comments
f _{CENTER} Tuning					
VTUNE Voltage	0		15	V	
Current (I _{TUNE})			±1	μA	
BAND CONTROL VOLTAGE (VCTL)					
Input Voltage					
Low	0		0.8	V	0 V for high band select
High	2	2.5	3	V	2.5 V for low band select
Current			1	μA	
SUPPLY VOLTAGES					
Negative (VEE)	-5.5	-5		V	
Positive (VDD)		5	5.5	V	
SUPPLY CURRENTS					
Negative (I _{EE})		0.7		mA	
Positive (I _{DD})			1	mA	

ABSOLUTE MAXIMUM RATINGS

Table 4.

Parameter	Rating
Tuning	
VTUNE	-0.5 V to +15 V
I _{TUNE}	±1 μA
Supply Voltages	
VEE	-5.6 V
VDD	5.6 V
VCTL	-0.5 V to VDD + 0.5 V
RF Input Power	
2 GHz to 50 GHz	27 dBm
0.5 GHz to 2 GHz	19 dBm
0 GHz to 0.5 GHz	6 dBm
Hot Switch Input Power	
2 GHz to 50 GHz	24 dBm
0.5 GHz to 2 GHz	16 dBm
0 GHz to 0.5 GHz	3 dBm
Temperature	
Operating	-40°C to +85°C
Storage Temperature	-65°C to +150°C
Junction for 1 Million Mean Times Between Failures (MTTF)	150°C
Nominal Junction (T _{PADDLE} = 85°C, input power (P _{IN}) = 23 dBm)	150°C
Electrostatic Discharge (ESD) Rating	
Human Body Model (HBM)	250 V
Field Induced Charge Device Model (FICDM)	1250 V
Moisture Sensitivity Level (MSL) Rating	MSL3

Stresses at or above those listed under Absolute Maximum Ratings may cause permanent damage to the product. This is a stress rating only; functional operation of the product at these or any other conditions above those indicated in the operational section of this specification is not implied. Operation beyond the maximum operating conditions for extended periods may affect product reliability.

ESD CAUTION



ESD (electrostatic discharge) sensitive device. Charged devices and circuit boards can discharge without detection. Although this product features patented or proprietary protection circuitry, damage may occur on devices subjected to high energy ESD. Therefore, proper ESD precautions should be taken to avoid performance degradation or loss of functionality.

PIN CONFIGURATION AND FUNCTION DESCRIPTIONS

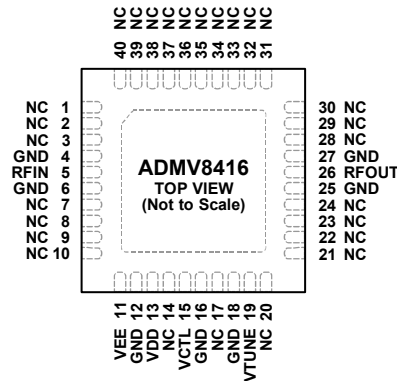

- NOTES**
1. NC = NO CONNECT. THESE PINS ARE NOT CONNECTED INTERNALLY. ALL DATA SHOWN WITHIN WAS MEASURED WITH THESE PINS CONNECTED TO RF AND DC GROUND EXTERNALLY.
 2. CONNECT THE EPAD TO RF AND DC GROUND.

Figure 2. Pin Configuration

Table 5. Pin Function Descriptions

Pin No.	Mnemonic	Description
1 to 3, 7 to 10, 14, 17, 20, 21 to 24, 28 to 40	NC	No Connect. These pins are not connected internally. All data shown within was measured with these pins connected to RF and dc ground externally.
4, 6, 12, 16, 18, 25, 27	GND	Ground. Connect these pins to RF and dc ground.
5	RFIN	RF Input. This pin is dc-coupled and matched to 50 Ω. Blocking capacitors are required if the RF line potential is not equal to 0 V.
11	VEE	Negative Supply Voltage. VEE is -5 V.
13	VDD	Positive Supply Voltage. VDD is 5 V.
15	VCTL	Control Voltage for Band Selection. The band-pass filter is in the high band when VCTL = 0 V and in the low band when VCTL = 2.5 V.
19	VTUNE	Center Frequency Control Voltage of the Band-Pass Filter. The voltage can vary from 0 V to 15 V.
26	RFOUT	RF Output. This pin is dc-coupled and matched to 50 Ω. Blocking capacitors are required if the RF line potential is not equal to 0 V.
	EPAD	Exposed Pad. Connect the EPAD to RF and dc ground.

INTERFACE SCHEMATICS

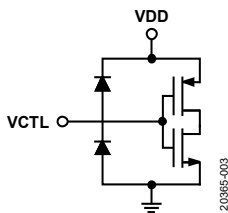

Figure 3. VCTL and VDD Interface Schematic

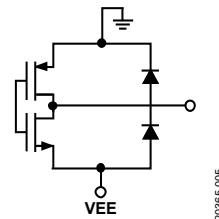

Figure 5. VEE Interface Schematic

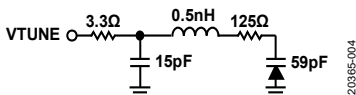

Figure 4. VTUNE Interface Schematic



Figure 6. GND Interface Schematic

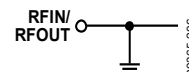

Figure 7. RFIN and RFOUT Interface Schematic

TYPICAL PERFORMANCE CHARACTERISTICS

HIGH BAND, VCTL = 0 V

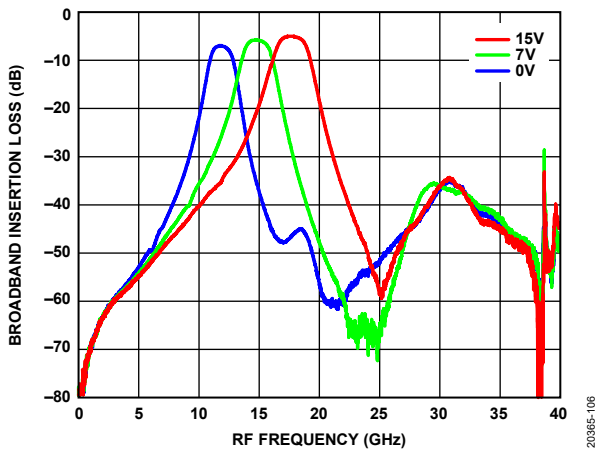

Figure 8. Broadband Insertion Loss vs. RF Frequency at Various Voltages

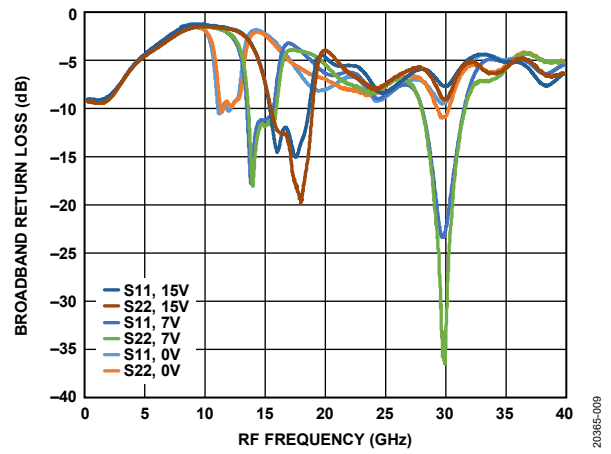

Figure 11. Broadband Return Loss vs. RF Frequency at Various Voltages and S11 and S22

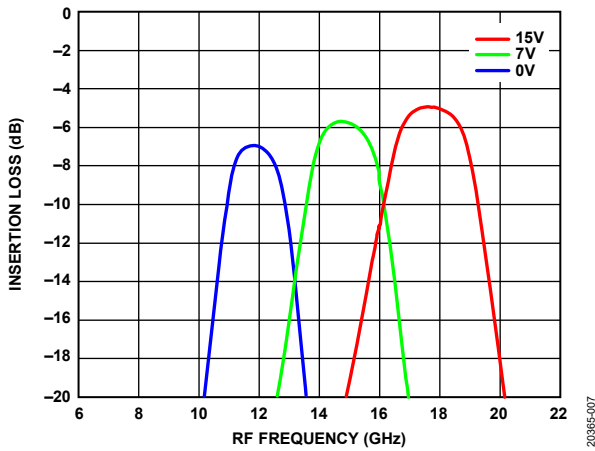

Figure 9. Insertion Loss vs. RF Frequency at Various Voltages

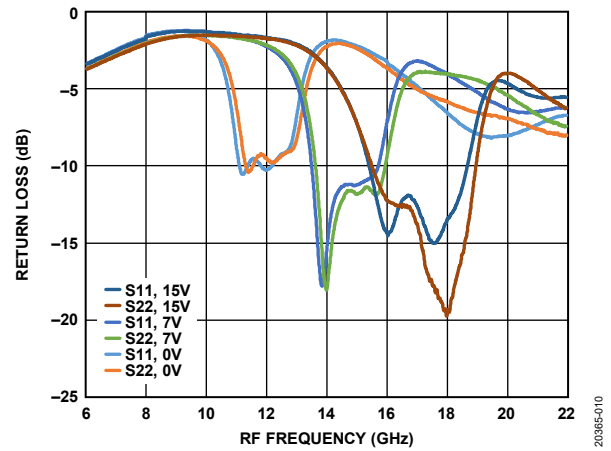

Figure 12. Return Loss vs. RF Frequency at Various Voltages and S11 and S22

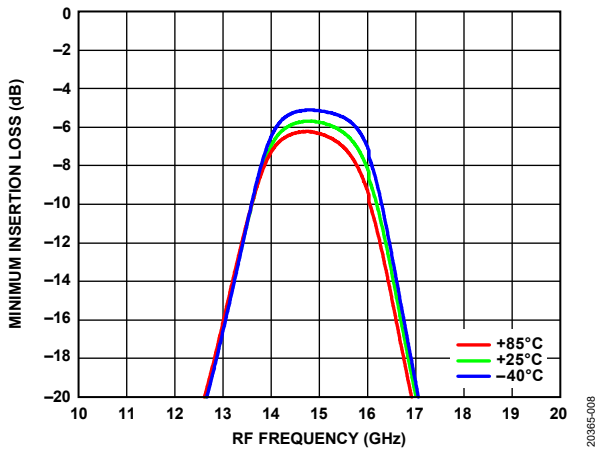

Figure 10. Minimum Insertion Loss vs. RF Frequency at Various Temperatures, VTUNE = 7 V

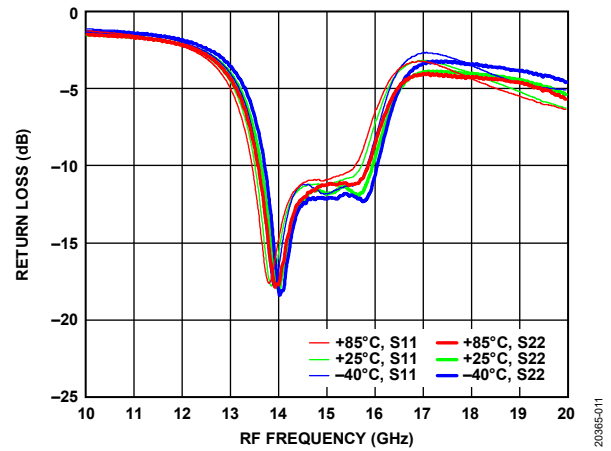

Figure 13. Return Loss vs. RF Frequency at Various Temperatures and S11 and S22, VTUNE = 7 V

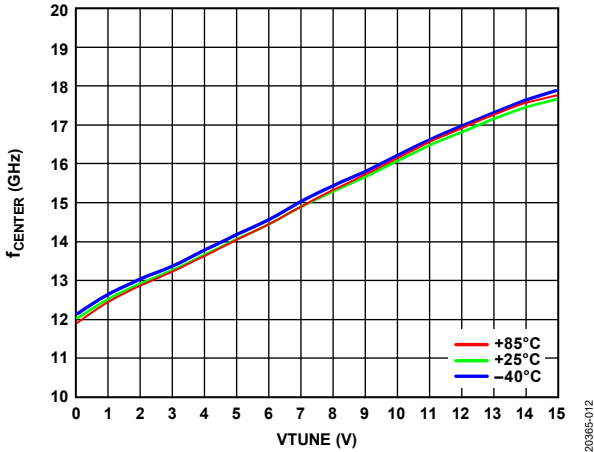

Figure 14. f_{CENTER} vs. $VTUNE$ at Various Temperatures

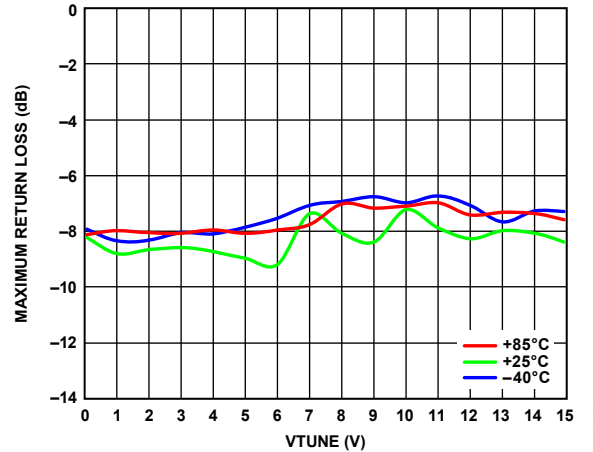

Figure 17. Maximum Return Loss in a 2 dB Bandwidth vs. $VTUNE$ at Various Temperatures

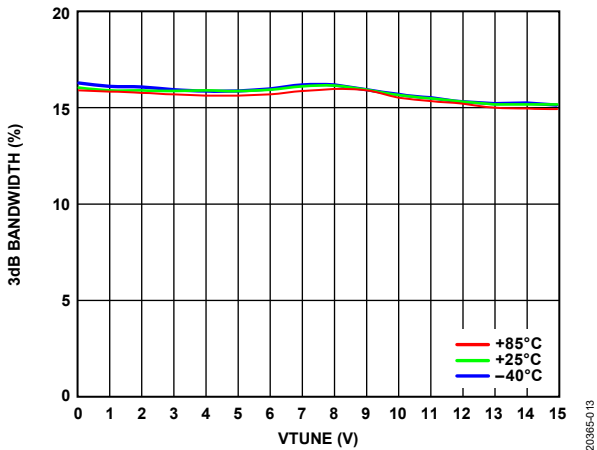

Figure 15. 3 dB Bandwidth vs. $VTUNE$ at Various Temperatures

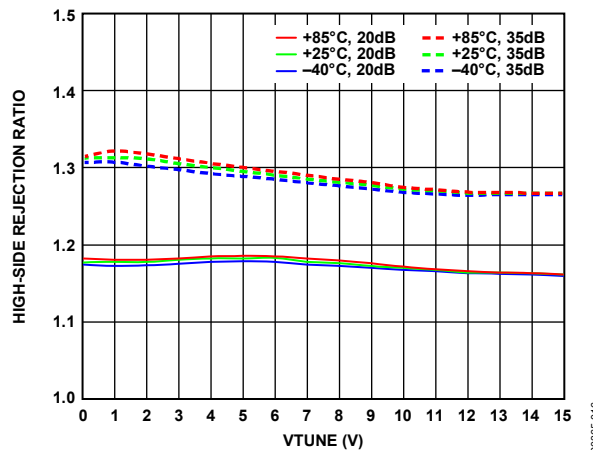

Figure 18. High-Side Rejection Ratio vs. $VTUNE$ at Various Temperatures and 20 dB and 35 dB

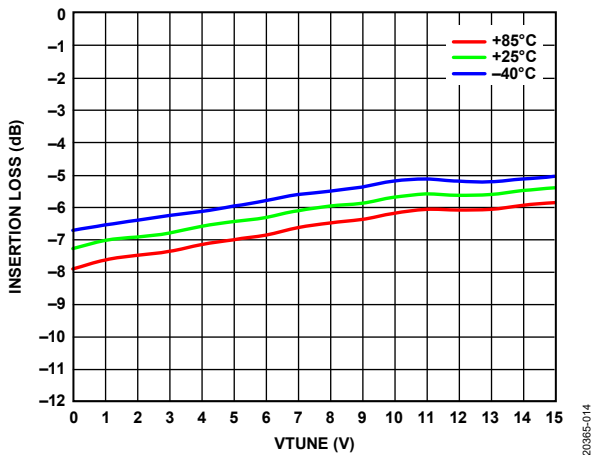

Figure 16. Insertion Loss vs. $VTUNE$ at Various Temperatures

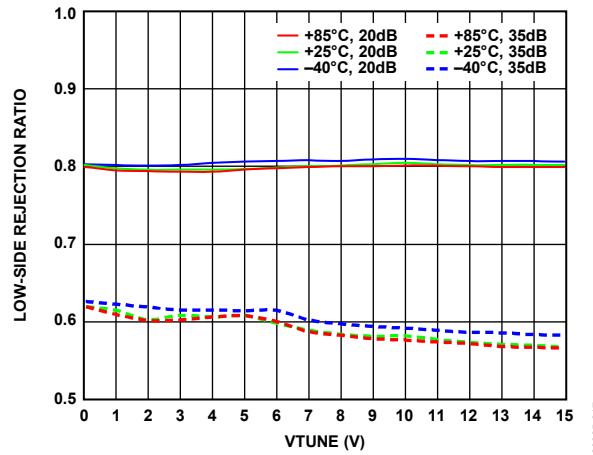

Figure 19. Low-Side Rejection Ratio vs. $VTUNE$ at Various Temperatures and 20 dB and 35 dB

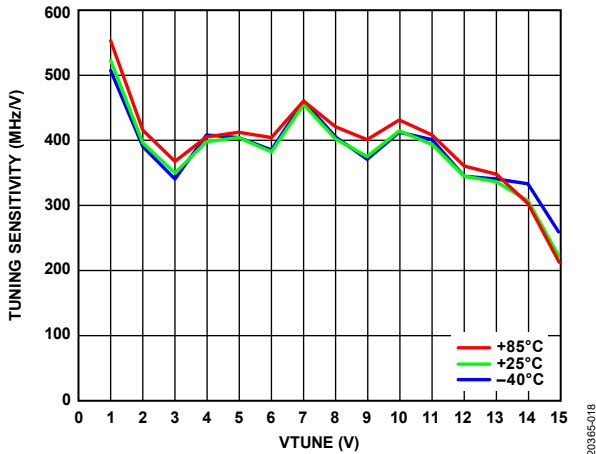

Figure 20. Tuning Sensitivity vs. VTUNE at Various Temperatures

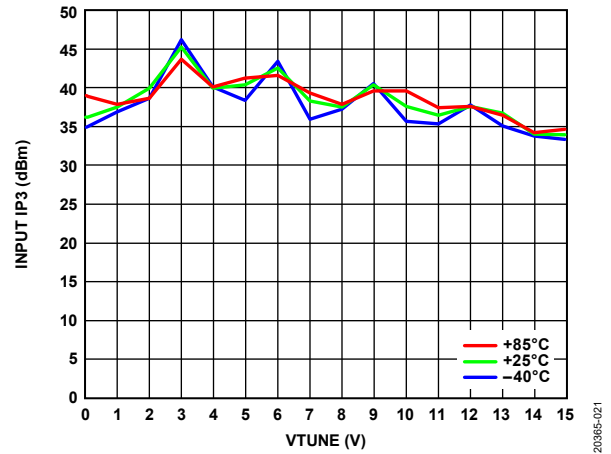

Figure 23. Input IP3 vs. VTUNE at Various Temperatures, Input Power = 20 dBm

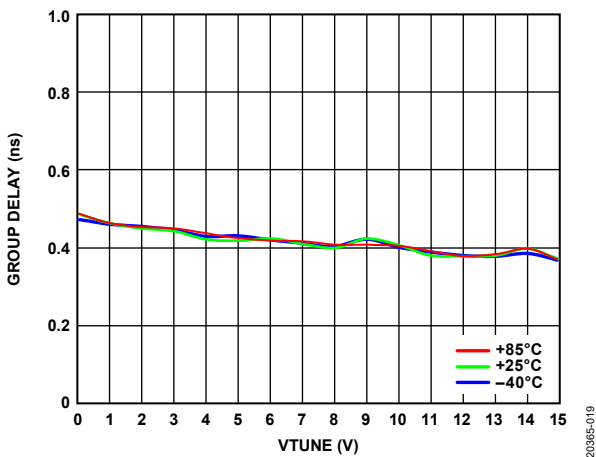

Figure 21. Group Delay vs. VTUNE at Various Temperatures

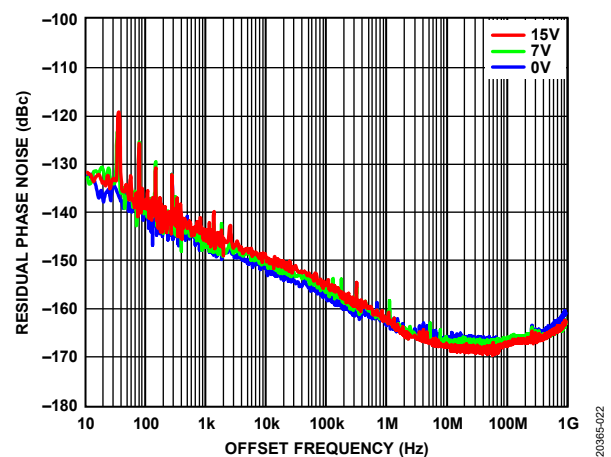

Figure 24. Residual Phase Noise vs. Offset Frequency at Various VTUNE

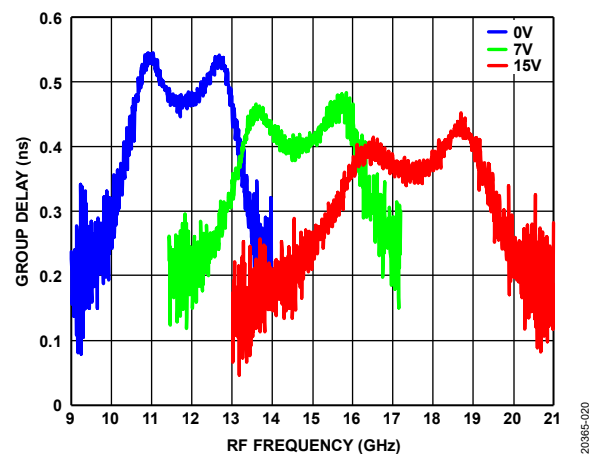

Figure 22. Group Delay vs. RF Frequency at Various VTUNE

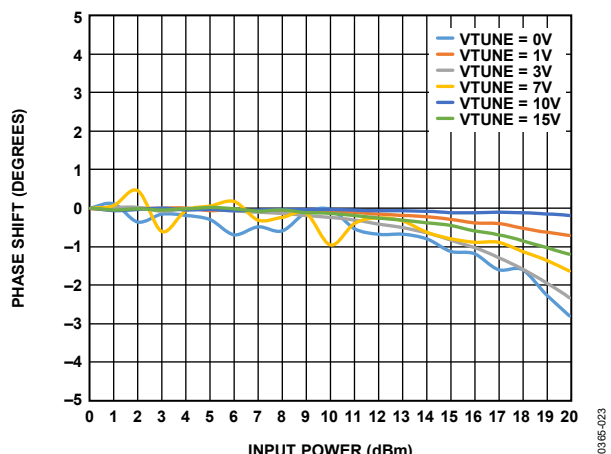

Figure 25. Phase Shift vs. Input Power at Various VTUNE

LOW BAND, VCTL = 2.5 V

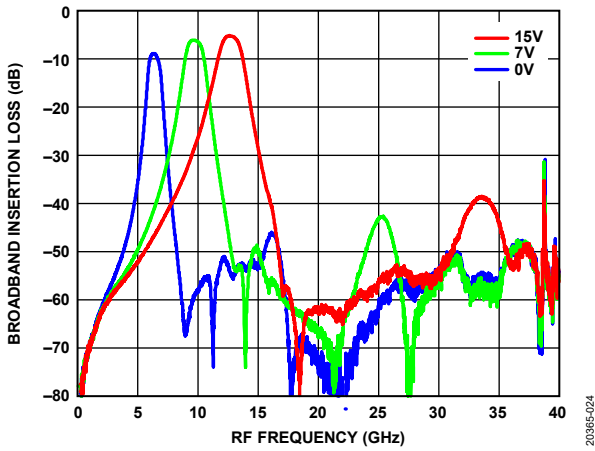

Figure 26. Broadband Insertion Loss vs. RF Frequency at Various Voltages

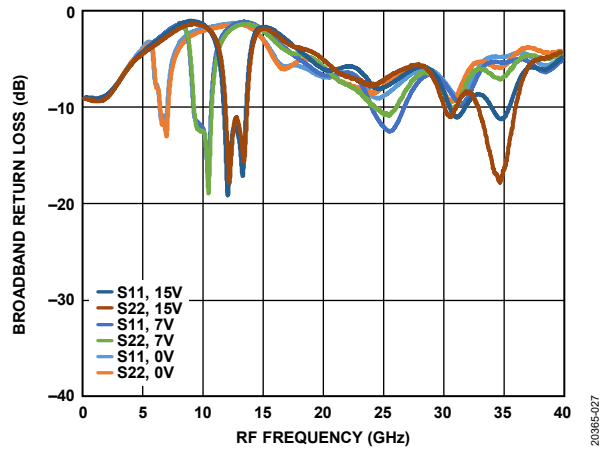

Figure 29. Broadband Return Loss vs. RF Frequency at Various Voltages and S11 and S22

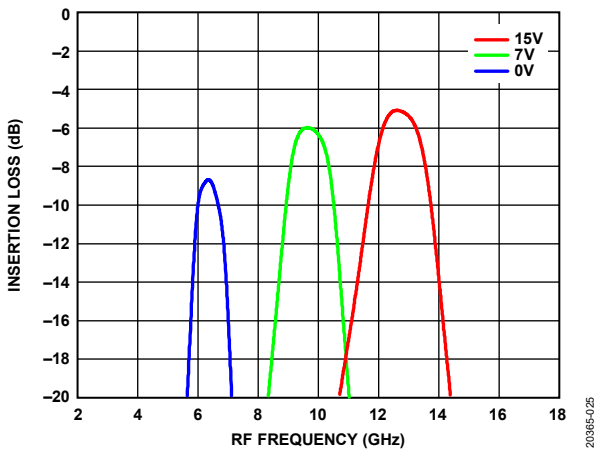

Figure 27. Insertion Loss vs. RF Frequency at Various Voltages

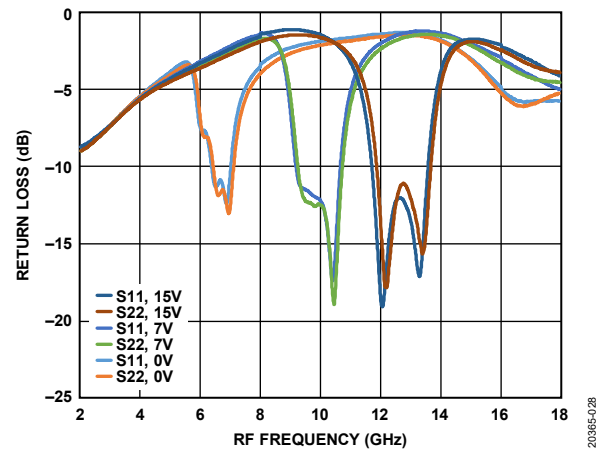

Figure 30. Return Loss vs. RF Frequency at Various Voltages and S11 and S22

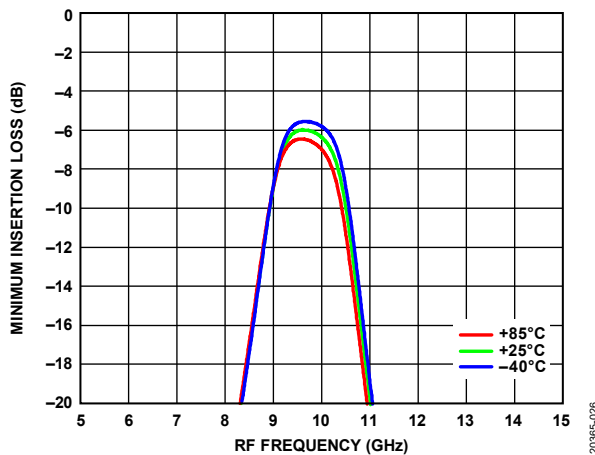

Figure 28. Minimum Insertion Loss vs. RF Frequency at Various Temperatures, VTUNE = 7 V

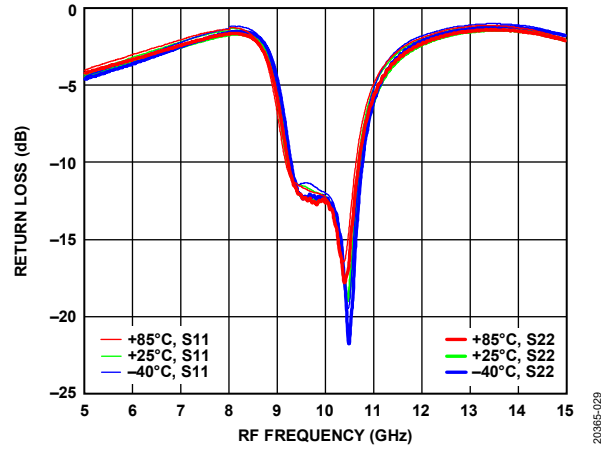

Figure 31. Return Loss vs. RF Frequency at Various Temperatures and S11 and S22, VTUNE = 7 V

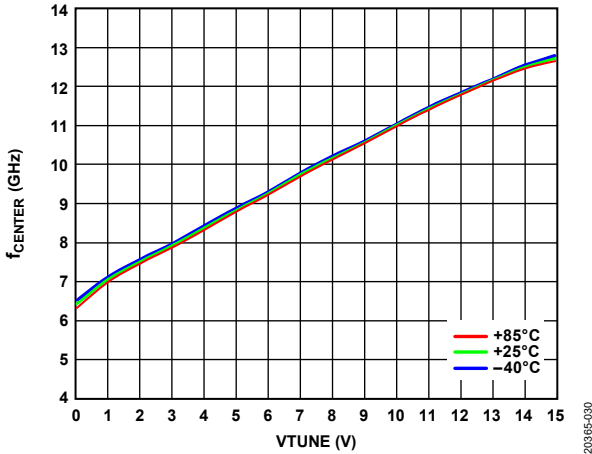

Figure 32. f_{CENTER} vs. $VTUNE$ at Various Temperatures

203865-030

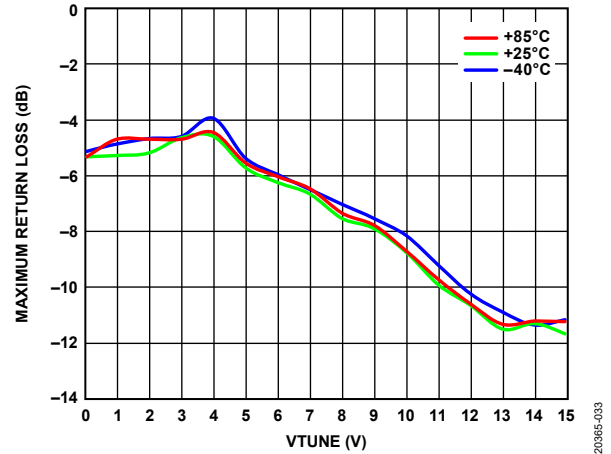

Figure 35. Maximum Return Loss in a 2 dB Bandwidth vs. $VTUNE$ at Various Temperatures

203865-033

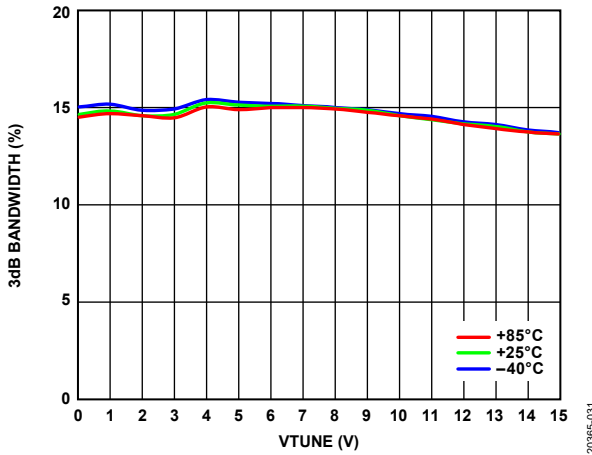

Figure 33. 3 dB Bandwidth vs. $VTUNE$ at Various Temperatures

203865-031

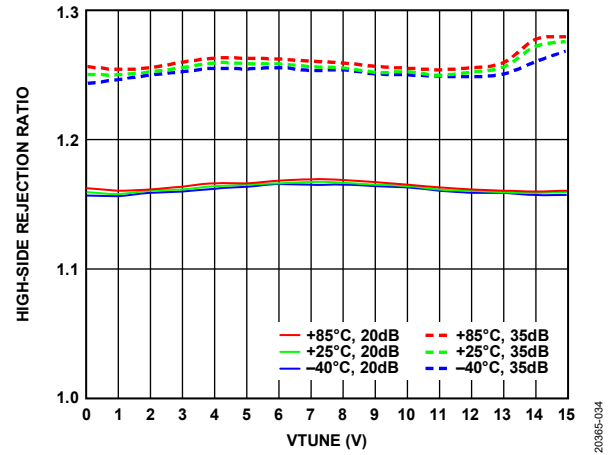

Figure 36. High-Side Rejection vs. $VTUNE$ at Various Temperatures and 20 dB and 35 dB

203865-034

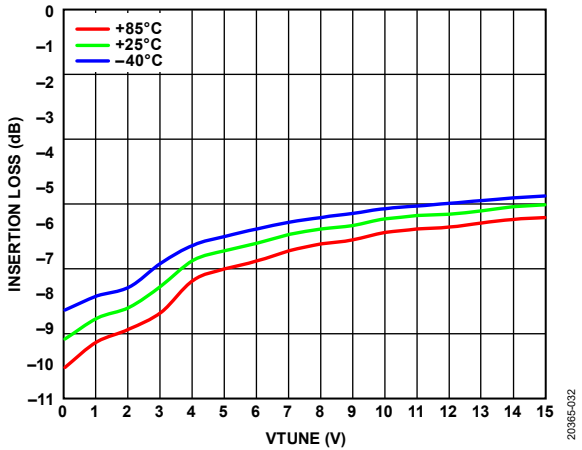

Figure 34. Insertion Loss vs. $VTUNE$ at Various Temperatures

203865-032

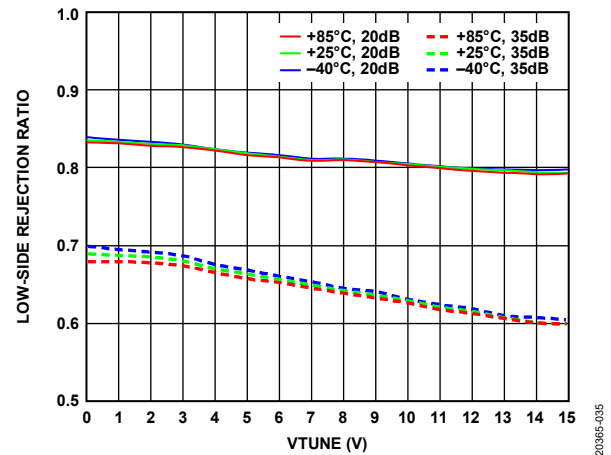

Figure 37. Low-Side Rejection vs. $VTUNE$ at Various Temperatures and 20 dB and 35 dB

203865-035

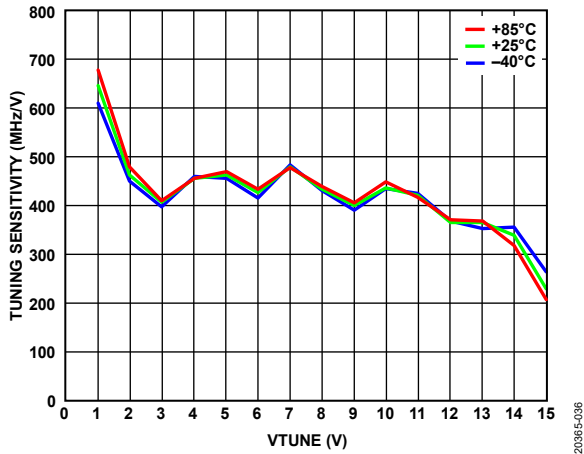

Figure 38. Tuning Sensitivity vs. VTUNE at Various Temperatures

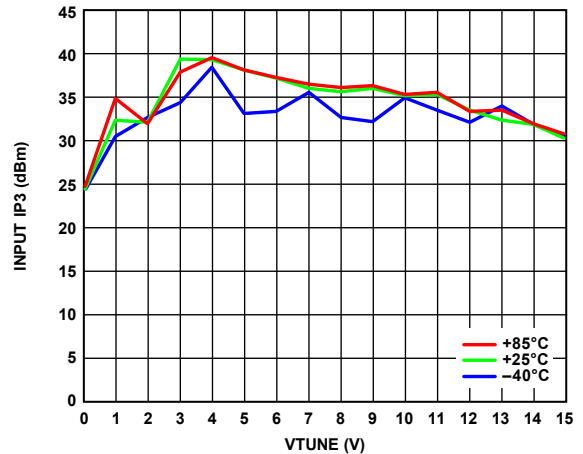

Figure 41. Input IP3 vs. VTUNE at Various Temperatures, Input Power (P_{IN}) = 20 dBm

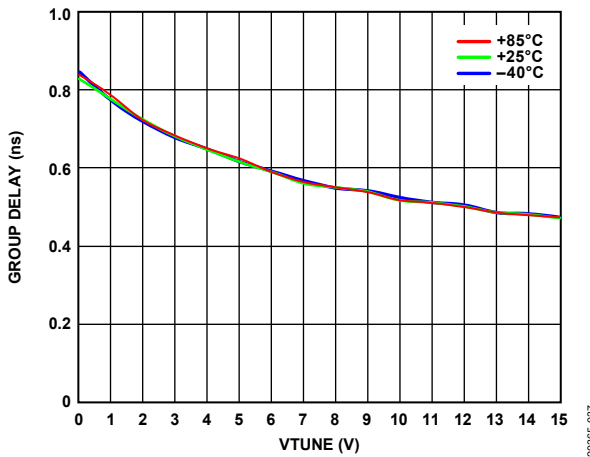

Figure 39. Group Delay vs. VTUNE at Various Temperatures

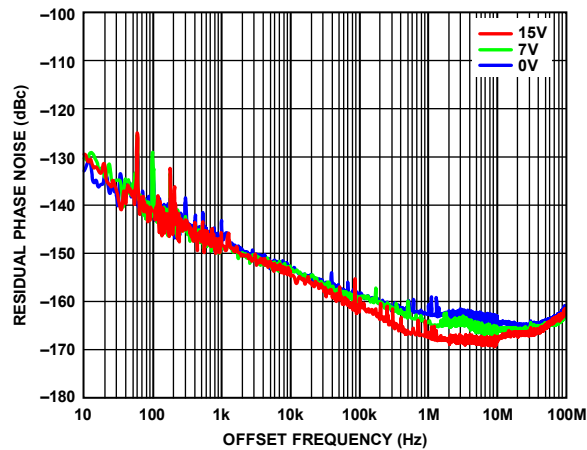

Figure 42. Residual Phase Noise vs. Offset Frequency at Various VTUNE

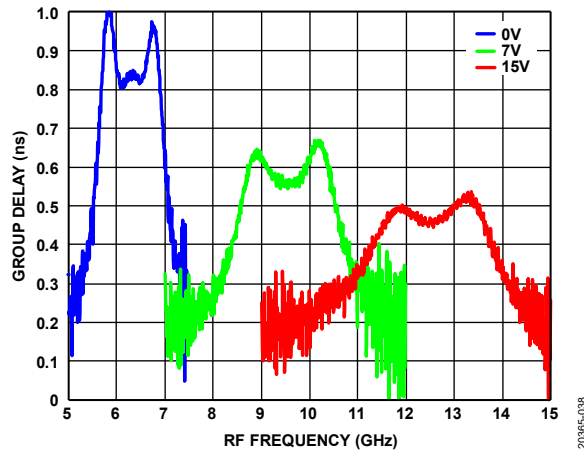

Figure 40. Group Delay vs. RF Frequency at Various VTUNE

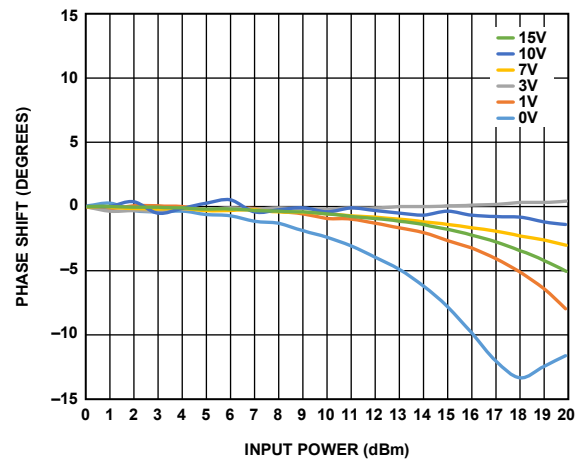

Figure 43. Phase Shift vs. Input Power at Various VTUNE

PHASE SENSITIVITY

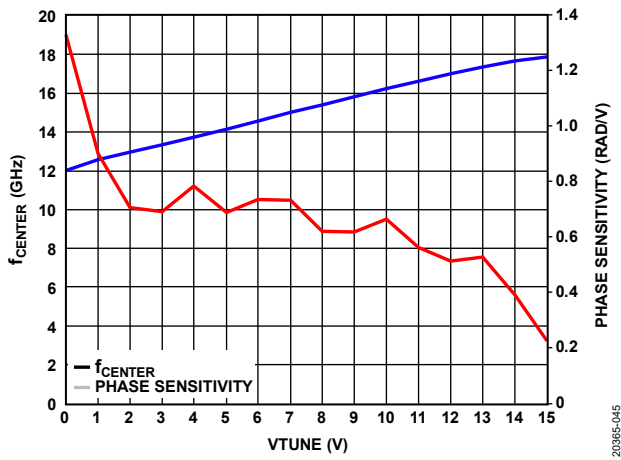

Figure 44. f_{CENTER} and Phase Sensitivity vs. VTUNE, High Band

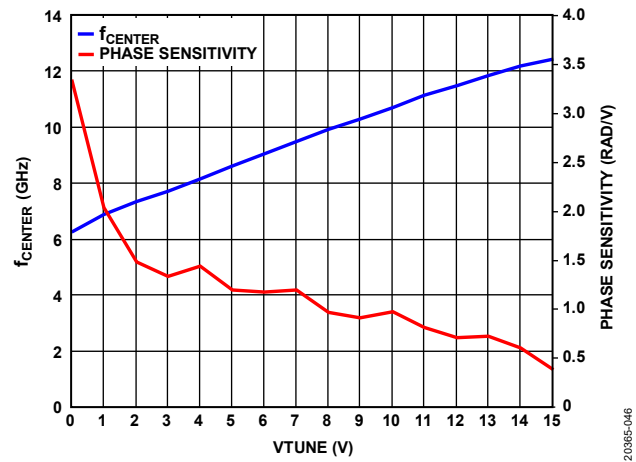

Figure 45. f_{CENTER} and Phase Sensitivity vs. VTUNE, Low Band

THEORY OF OPERATION

The ADMV8416 is a MMIC, band-pass filter that features a user-selectable pass-band frequency.

VCTL is control voltage for selecting low or high band-pass filtering. VCTL sets the switch positions for low and high band-pass operation. When VCTL = 0 V, the high band-pass filter is selected, which has an f_{CENTER} range from 12.5 GHz to 16 GHz.

When VCTL = 2.5 V, the low band-pass filter is selected, which has an f_{CENTER} range from 7 GHz to 12 GHz.

The f_{CENTER} is adjustable by supplying VTUNE, which varies from 0 V to 15 V. In typical operation, turn on the level shifter by applying the correct voltage on the VDD pin and VEE pin, then control the switch by supplying the VCTL pin, and lastly, supply the VTUNE for the f_{CENTER} .

APPLICATIONS INFORMATION

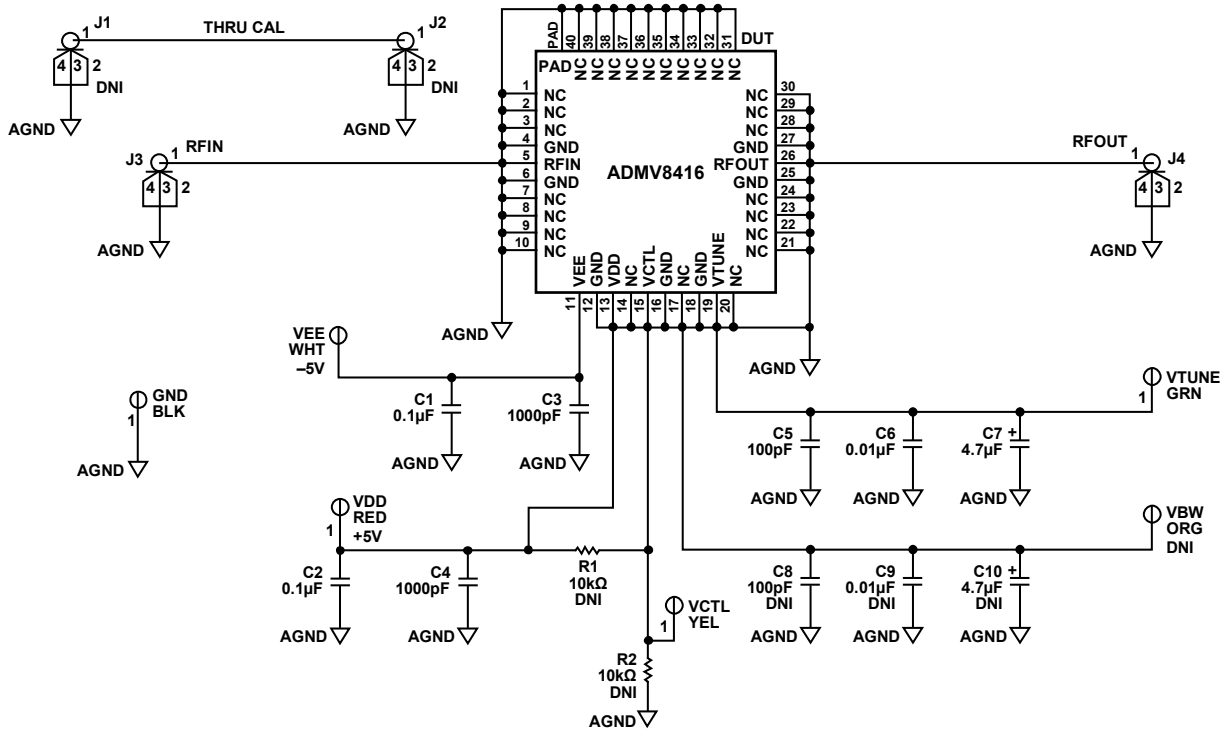

Figure 46. Typical Application Circuit

TYPICAL APPLICATION CIRCUIT

Figure 46 shows the typical application circuit for the ADMV8416. The RFIN pin and RFOUT pin are dc-coupled, and blocking capacitors are required if the RF line potential is not equal to 0 V.

2036E-042

OUTLINE DIMENSIONS

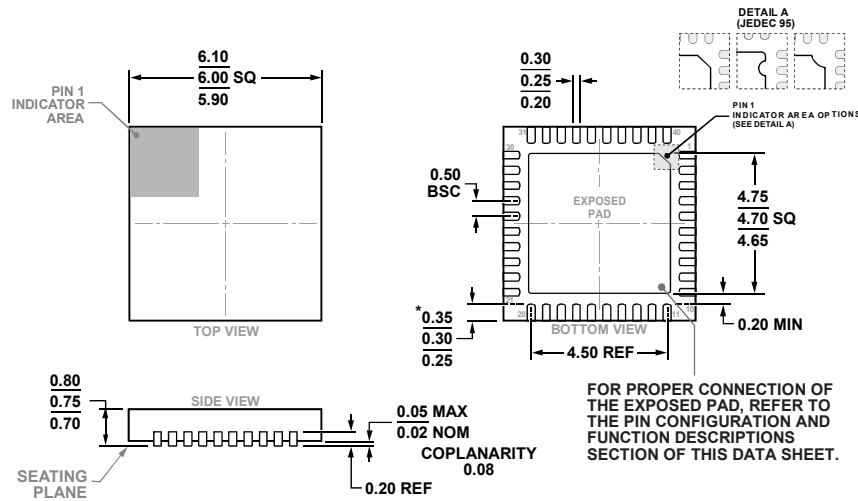

*COMPLIANT TO JEDEC STANDARDS MO-220-WJJD-5 WITH EXCEPTION TO LEAD LENGTH

Figure 47. 40-Lead Lead Frame Chip Scale Package [LFCSP]
6 mm × 6 mm Body and 0.75 mm Package Height
(CP-40-27)
Dimensions shown in millimeters

ORDERING GUIDE

Model ¹	Temperature Range	Package Description	Package Option
ADMV8416ACPZ	-40°C to +85°C	40-Lead Lead Frame Chip Scale Package [LFCSP]	CP-40-27
ADMV8416ACPZ-R5	-40°C to +85°C	40-Lead Lead Frame Chip Scale Package [LFCSP], 5" Tape and Reel	CP-40-27
ADMV8416-EVALZ		Evaluation Board	

¹ Z = RoHS Compliant Part.