

AN-1954 LM3409 Demonstration Board

1 Introduction

This demonstration board showcases the LM3409 PFET controller for a buck current regulator. It is designed to drive 4 LEDs ($V_O = 15V$) at a maximum average LED current ($I_{LED} = 1A$) from a DC input voltage ($V_{IN} = 24V$). The switching frequency ($f_{SW} = 525\text{ kHz}$) is targeted for the nominal operating point, however f_{SW} varies across the entire operating range. The circuit can accept an input voltage of 6V-42V. However, if the input voltage drops below the regulated LED string voltage, the converter goes into dropout and $V_O = V_{IN}$ ideally.

The PCB is made using 2 layers of 2 oz. copper with FR4 dielectric. The board showcases several features of the LM3409 including both analog dimming using a potentiometer (R5) tied to the IADJ pin and internal PWM dimming using the EN pin. There is a header (J1) with a removable jumper, which is used to select PWM dimming or low power shutdown.

The board has a right angle connector (J2) which can mate with an external LED load board allowing for the LEDs to be mounted close to the driver. This reduces potential ringing when there is no output capacitor. Alternatively, the LED+ and LED- turrets can be used to connect the LED load.

This board can be easily modified to demonstrate other operating points as shown in [Section 8](#). The *LM3409 / LM3409HV / LM3409Q / LM3409QHV / LM3409N PFET Buck Controller for High Power LED Drivers* ([SNVS602](#)) data sheet's *Design Procedure* can be used to design for any set of specifications.

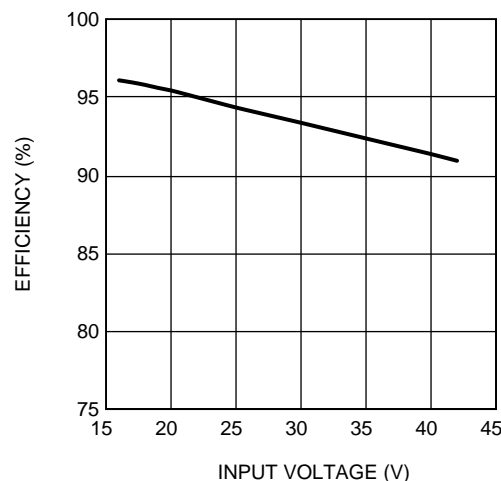

Figure 1. Efficiency with 4 Series LEDs AT 1A

2 Schematic

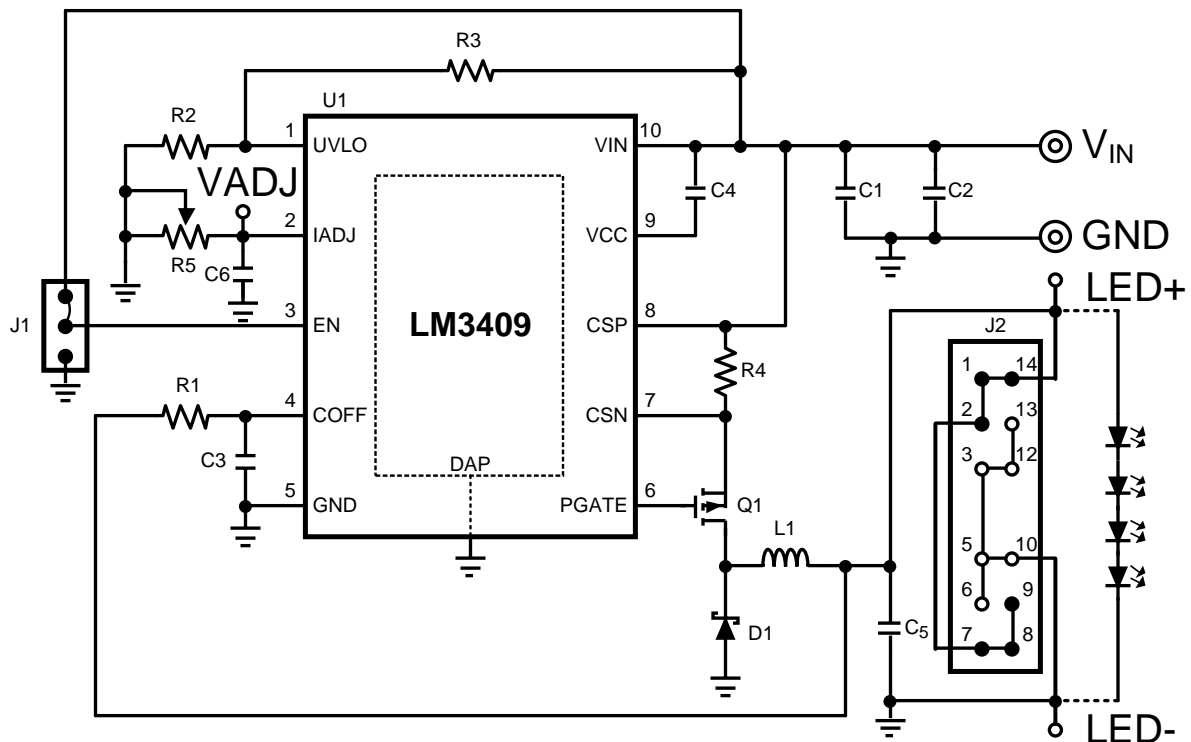

Figure 2. Board Schematic

3 Pin Descriptions

Pin(s)	Name	Description	Application Information
1	UVLO	Input under-voltage lockout	Connect to a resistor divider from V_{IN} and GND. Turn-on threshold is 1.24V and hysteresis for turn-off is provided by a 22 μ A current source.
2	IADJ	Analog LED current adjust	Apply a voltage between 0 - 1.24V, connect a resistor to GND, or leave open to set the current sense threshold voltage.
3	EN	Logic level enable	Apply a voltage >1.74V to enable device, a PWM signal to dim, or a voltage <0.5V for low power shutdown.
4	COFF	Off-time programming	Connect resistor to V_O , and capacitor to GND to set the off-time.
5	GND	Ground	Connect to the system ground.
6	PGATE	Gate drive	Connect to the gate of the external PFET.
7	CSN	Negative current sense	Connect to the negative side of the sense resistor.
8	CSP	Positive current sense	Connect to the positive side of the sense resistor (V_{IN}).
9	VCC	V_{IN} -referenced linear regulator output	Connect at least a 1 μ F ceramic capacitor to V_{IN} . The regulator provides power for the PFET drive.
10	VIN	Input voltage	Connect to the input voltage.
DAP	DAP	Thermal pad on bottom of IC	Connect to pin 5 (GND). Place 4-6 vias from DAP to bottom GND plane.

4 Bill of Materials

Table 1. Bill of Materials

Qty	Part ID	Part Value	Manufacturer	Part Number
1	U1	Buck controller	Texas Instruments	LM3409
1	C1	4.7 μ F X7R 20% 50V	MURATA	GRM55ER71H475MA01L
1	C2, C5	No Load		
1	C3	470pF X7R 10% 50V	TDK	C1608X7R1H471K
1	C4	1.0 μ F X7R 10% 16V	TDK	C1608X7R1C105K
1	C6	0.1 μ F 50V 10% X7R	MURATA	C1608X7R1C104K
1	Q1	PMOS 70V 5.7A	ZETEX	ZXMP7A17KTC
1	D1	Schottky 60V 5A	VISHAY	CDBC560-G
1	L1	22 μ H 20% 3.5A	TDK	SLF12565T-220M3R5
1	R1	15.4k Ω 1%	VISHAY	CRCW060315K4FKEA
1	R2	6.98k Ω 1%	VISHAY	CRCW06036K98FKEA
1	R3	49.9k Ω 1%	VISHAY	CRCW060349K9FKEA
1	R4	0.2 Ω 1% 1W	VISHAY	WSL2512R2000FEA
1	R5	250k Ω potentiometer	BOURNS	3352P-1-254
1	J1		MOLEX	22-28-4033
1	J2		SAMTEC	TSSH-107-01-S-D-RA
2	VIN, GND		KEYSTONE	575-8
3	VADJ, LED+, LED-		KEYSTONE	1502-2

5 PCB Layout

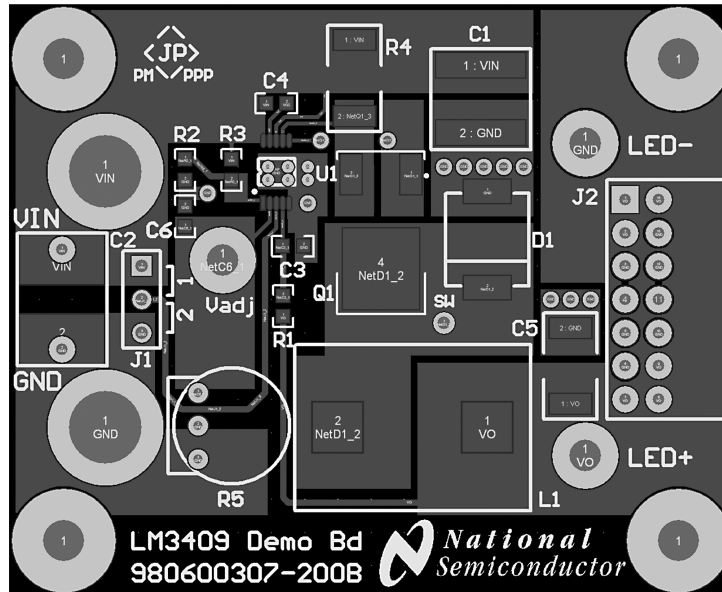

Figure 3. Top Layer

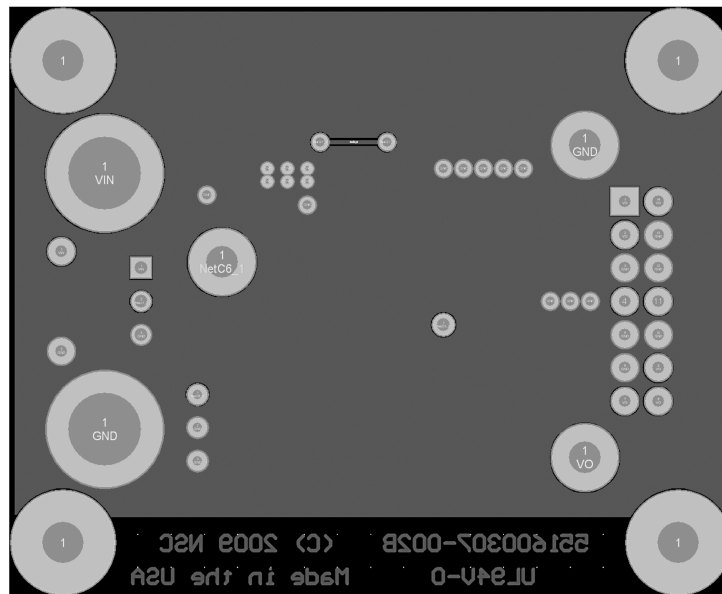

Figure 4. Bottom Layer

6 Design Procedure

6.1 Specifications

$$V_{IN} = 24V; V_{IN-MAX} = 42V$$

$$V_O = 15V$$

$$f_{SW} = 525kHz$$

$$I_{LED} = 1A$$

$$\Delta i_{LED-PP} = \Delta i_{L-PP} = 450mA$$

$$\Delta v_{IN-PP} = 720mV$$

$$V_{TURN-ON} = 10V; V_{HYS} = 1.1V$$

$$\eta = 0.95$$

6.2 Nominal Switching Frequency

Assume C3 = 470pF and $\eta = 0.95$. Solve for R1:

$$R1 = \frac{-\left(1 - \frac{V_O}{\eta \times V_{IN}}\right)}{(C3 + 20 \text{ pF}) \times f_{SW} \times \ln\left(1 - \frac{1.24V}{V_O}\right)}$$

$$R1 = \frac{-\left(1 - \frac{15V}{0.95 \times 24V}\right)}{490 \text{ pF} \times 525 \text{ kHz} \times \ln\left(1 - \frac{1.24V}{15V}\right)} = 15.4 \text{ k}\Omega \quad (1)$$

The closest 1% tolerance resistor is 15.4 k Ω therefore the actual t_{OFF} and target f_{SW} are:

$$t_{OFF} = -(C3 + 20 \text{ pF}) \times R1 \times \ln\left(1 - \frac{1.24V}{V_O}\right)$$

$$t_{OFF} = -490 \text{ pF} \times 15.4 \text{ k}\Omega \times \ln\left(1 - \frac{1.24V}{15V}\right) = 651 \text{ ns} \quad (2)$$

$$f_{SW} = \frac{1 \cdot \left(\frac{V_O}{\eta \times V_{IN}}\right)}{t_{OFF}} = \frac{1 \cdot \left(\frac{15V}{0.95 \times 24V}\right)}{651 \text{ ns}} = 525 \text{ kHz} \quad (3)$$

The chosen components from step 1 are:

C3 = 470 pF R1 = 15.4 k Ω

(4)

6.3 Inductor Ripple Current

Solve for L1:

$$L1 = \frac{V_O \times t_{OFF}}{\Delta i_{L-PP}} = \frac{15V \times 651 \text{ ns}}{450mA} = 21.7 \mu H \quad (5)$$

The closest standard inductor value is 22 μH therefore the actual Δi_{L-PP} is:

$$\Delta i_{L-PP} = \frac{V_O \times t_{OFF}}{L1} = \frac{15V \times 651 \text{ ns}}{22 \mu H} = 444 \text{ mA} \quad (6)$$

The chosen component from step 2 is:

L1 = 22 μH

(7)

6.4 Average LED Current

Determine I_{L-MAX} :

$$I_{L-MAX} = I_{LED} + \frac{\Delta I_{L-PP}}{2} = 1A + \frac{444mA}{2} = 1.22A \quad (8)$$

Assume $V_{ADJ} = 1.24V$ and solve for R4:

$$R4 = \frac{V_{ADJ}}{5 \times I_{L-MAX}} = \frac{1.24V}{5 \times 1.22A} = 0.203\Omega \quad (9)$$

The closest 1% tolerance resistor is 0.2 Ω therefore the I_{LED} is:

$$I_{LED} = \frac{V_{ADJ}}{5 \times R4} - \frac{\Delta I_{L-PP}}{2}$$

$$I_{LED} = \frac{1.24V}{5 \times 0.2\Omega} - \frac{444mA}{2} = 1.02A \quad (10)$$

The chosen component from step 3 is:

$$R4 = 0.2\Omega \quad (11)$$

6.5 Output Capacitance

No output capacitance is necessary.

6.6 Input Capacitance

Determine t_{ON} :

$$t_{ON} = \frac{1}{f_{SW}} - t_{OFF} = \frac{1}{525kHz} - 651ns = 1.25\mu s \quad (12)$$

Solve for C_{IN-MIN} :

$$C_{IN-MIN} = \frac{I_{LED} \times t_{ON}}{\Delta V_{IN-PP}} = \frac{1.02A \times 1.25\mu s}{720mV} = 1.77\mu F \quad (13)$$

Choose C_{IN} :

$$C_{IN} = C_{IN-MIN} \times 2 = 3.54\mu F \quad (14)$$

Determine I_{IN-RMS} :

$$I_{IN-RMS} = I_{LED} \times f_{SW} \times \sqrt{t_{ON} \times t_{OFF}}$$

$$I_{IN-RMS} = 1.02A \times 525kHz \times \sqrt{1.25\mu s \times 651ns} = 483mA \quad (15)$$

The chosen components from step 5 are:

$$C1 = 4.7\mu F \quad (16)$$

6.7 P-Channel MOSFET

Determine minimum Q1 voltage rating and current rating:

$$V_{T-MAX} = V_{IN-MAX} = 42V \quad (17)$$

$$I_T = D \times I_{LED} = \frac{V_O \times I_{LED}}{V_{IN} \times \eta} = \frac{15V \times 1.02A}{24V \times 0.95} = 670mA \quad (18)$$

A 70V, 5.7A PFET is chosen with $R_{DS-ON} = 190m\Omega$ and $Q_g = 20nC$. Determine I_{T-RMS} and P_T :

$$I_{T-RMS} = I_{LED} \times \sqrt{D \times \left(1 + \frac{1}{12} \times \left(\frac{\Delta I_{L-PP}}{I_{LED}} \right)^2 \right)}$$

$$I_{T-RMS} = 1.02A \times \sqrt{\frac{15V}{24V \times 0.95} \times \left(1 + \frac{1}{12} \times \left(\frac{444 \text{ mA}}{1.02A} \right)^2 \right)}$$

$$I_{T-RMS} = 830 \text{ mA}$$

(19)

$$P_T = I_{T-RMS}^2 \times R_{DS(ON)} = 830 \text{ mA}^2 \times 190 \text{ m}\Omega = 132 \text{ mW}$$

(20)

The chosen component from step 6 is:

$$Q1 \rightarrow 5.7A, 70V, \text{DPAK}$$

(21)

6.8 Re-Circulating Diode

Determine minimum D1 voltage rating and current rating:

$$V_{D-MAX} = V_{IN-MAX} = 42V$$

(22)

$$I_D = (1-D) \times I_{LED} = \left(1 - \frac{V_O}{V_{IN} \times \eta} \right) \times I_{LED}$$

$$I_D = \left(1 - \frac{15V}{24V \times 0.95} \right) \times 1.02A = 348 \text{ mA}$$

(23)

A 60V, 5A diode is chosen with $V_D = 750\text{mV}$. Determine P_D :

$$P_D = I_D \times V_D = 348 \text{ mA} \times 750 \text{ mV} = 261 \text{ mW}$$

(24)

The chosen component from step 7 is:

$$D1 \rightarrow 5A, 60V, \text{SMC}$$

(25)

6.9 Input Under-Voltage Lockout (UVLO)

Solve for R3:

$$R3 = \frac{V_{HYS}}{22 \mu A} = \frac{1.1V}{22 \mu A} = 50 \text{ k}\Omega$$

(26)

The closest 1% tolerance resistor is 49.9 k Ω therefore V_{HYS} is:

$$V_{HYS} = R3 \times 22 \mu A = 49.9 \text{ k}\Omega \times 22 \mu A = 1.1V$$

(27)

Solve for R2:

$$R2 = \frac{1.24V \times R3}{V_{TURN-ON} - 1.24V} = \frac{1.24V \times 49.9 \text{ k}\Omega}{10V - 1.24V} = 7.06 \text{ k}\Omega$$

(28)

The closest 1% tolerance resistor is 6.98 k Ω therefore $V_{TURN-ON}$ is:

$$V_{TURN-ON} = \frac{1.24V \times (R2 + R3)}{R2}$$

$$V_{TURN-ON} = \frac{1.24V \times (6.98 \text{ k}\Omega + 49.9 \text{ k}\Omega)}{6.98 \text{ k}\Omega} = 10.1V$$

(29)

The chosen components from step 8 are:

$$\begin{aligned} R2 &= 6.98 \text{ k}\Omega \\ R3 &= 49.9 \text{ k}\Omega \end{aligned}$$

(30)

6.10 IADJ Connection Method

The IADJ pin controls the high-side current sense threshold as outlined in the data sheet. The LM3409 demonstration board allows for two methods to be evaluated using the IADJ pin. The desired method is chosen as follows:

Method #1: Applying an external voltage to the VADJ terminal between 0 and 1.24V linearly scales the current sense threshold between 0 and 248mV nominally.

Method #2: If no voltage is applied to the VADJ terminal, the internal 5μA current source will bias the voltage across the external potentiometer (R5). The potentiometer can be used to adjust the current sense threshold also. It is sized knowing the maximum desired average LED current which is chosen as $I_{LED} = 1A$:

$$R5 = \frac{\left(I_{LED} + \frac{\Delta I_{L-PP}}{2}\right) \times R4}{1 \mu A} = \frac{\left(1.02A + \frac{444 \text{ mA}}{2}\right) \times 200 \text{ m}\Omega}{1 \mu A}$$

$$R5 = 248 \text{ k}\Omega \tag{31}$$

The next highest standard potentiometer of 250kΩ is used. A 0.1μF capacitor (C6) is added from the IADJ pin to GND in order to eliminate unwanted high frequency noise coupling on the IADJ pin.

The chosen components from step 9 are:

$R5 = 250 \text{ k}\Omega$ $C6 = 0.1 \mu F$
--

(32)

The [Section 7 Typical Waveforms](#) shows a typical LED current waveform when analog dimming using the potentiometer. See the *Alternate Designs* section for two designs that are optimized to improve analog dimming range by reducing the switching frequency, increasing the inductance, and adding output capacitance.

6.11 PWM Dimming / Shutdown Method

The LM3409 demonstration board allows for PWM dimming and low power shutdown to be evaluated. The desired method is chosen as follows:

- 1: No PWM, $EN = V_{IN}$
- 2: Shutdown, $EN = GND$
- 3: Internal PWM, using EN

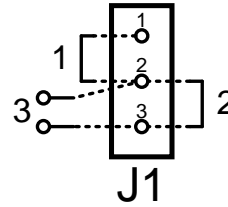

Method #1: If no PWM dimming is desired, a jumper should be placed in position 1 (shorts pins 1 and 2) on header J1. This shorts V_{IN} and EN which ensures the controller is always enabled if an input voltage greater than 1.74V is applied.

Method #2: Low power shutdown (typically 110 μ A) can be evaluated by placing the jumper in position 2 (shorts pins 2 and 3) on header J1. This shorts EN and GND which ensures the controller is shutdown.

Method #3: Internal PWM dimming using the EN pin can be evaluated by removing the jumper from header J1. An external PWM signal can then be applied to the EN terminal to provide PWM dimming. The R5 potentiometer should be rotated fully clockwise to use PWM dimming across the entire LED current range of the demonstration board. The *Typical Waveforms* section shows a typical LED current waveform during PWM dimming.

6.12 11. Bypass Capacitor

The internal regulator requires at least 1 μ F of ceramic capacitance with a voltage rating of 16V.

The chosen component from step 11 is:

$$C4 = 1.0 \mu\text{F}$$

(33)

7 Typical Waveforms

$T_A = +25^\circ\text{C}$, $V_{IN} = 24\text{V}$ and $V_O = 15\text{V}$.

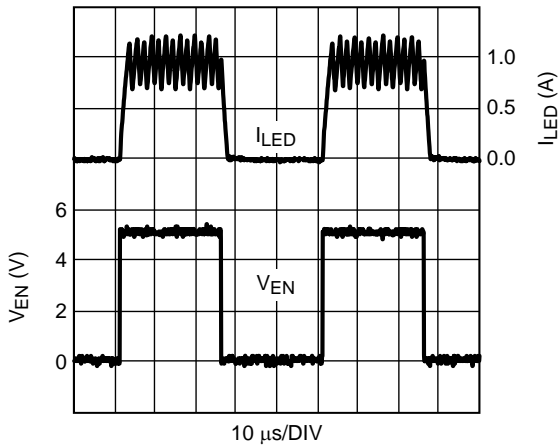

Figure 5. 20kHz 50% EN pin PWM dimming

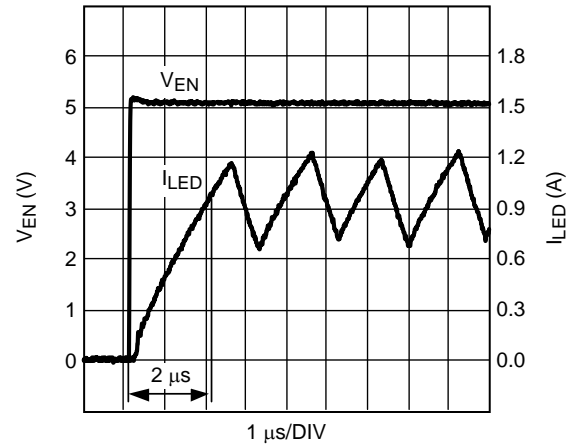

Figure 6. 20kHz 50% EN pin PWM dimming (rising edge)

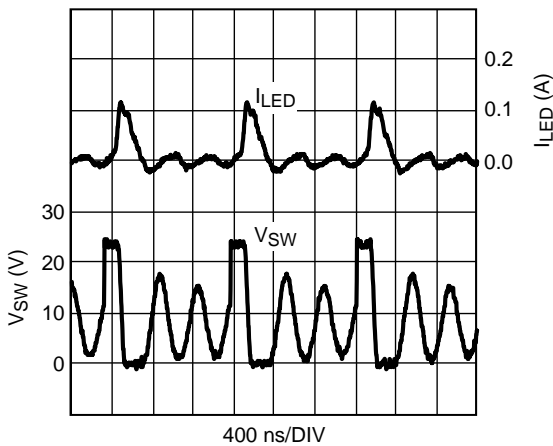

Figure 7. Analog dimming minimum (R5 fully counterclockwise)

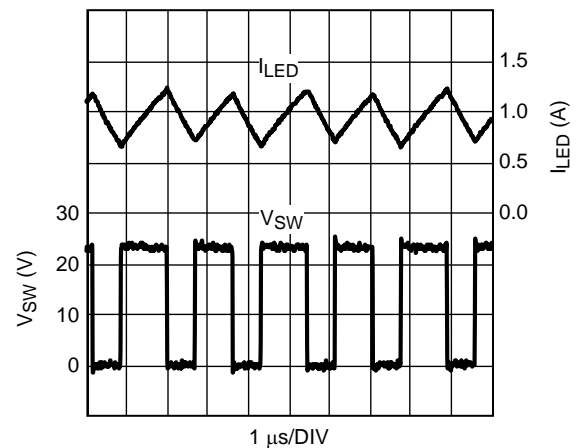

Figure 8. Analog dimming with maximum (R5 fully clockwise)

8 Alternate Designs

Alternate designs with the LM3409 demonstration board are possible with very few changes to the existing hardware. The evaluation board FETs and diodes are already rated higher than necessary for design flexibility. The input UVLO can remain the same and the input capacitance is sufficient for most designs, though the input voltage ripple will change. Other designs can be evaluated by changing R1, R4, L1, and C5.

The table below gives the main specifications for four different designs and the corresponding values for R1, R4, L1, and C5. The RMS current rating of L1 should be at least 50% higher than the specified I_{LED} . Designs 2 and 4 are optimized for best analog dimming range, while designs 1 and 3 are optimized for best PWM dimming range. These are just examples, however any combination of specifications can be achieved by following the **Design Procedure** in the *LM3409 / LM3409HV / LM3409Q / LM3409QHV / LM3409N PFET Buck Controller for High Power LED Drivers* ([SNVS602](#)) data sheet.

Specification / Component	Design 1	Design 2	Design 3	Design 4
Dimming Method	PWM	Analog	PWM	Analog
V_{IN}	24V	12V	36V	42V
V_O	14V	7V	24V	35V
f_{SW}	500 kHz	250 kHz	450 kHz	300 kHz
I_{LED}	1A	3A	700 mA	2A
Δi_{LED}	450 mA	70 mA	250 mA	60 mA
R1	15.4 k Ω	15.4 k Ω	25.5 k Ω	24.9 k Ω
R4	0.2 Ω	0.08 Ω	0.3 Ω	0.12 Ω
L1	22 μ H	33 μ H	68 μ H	68 μ H
C5	None	1 μ F	None	1 μ F

IMPORTANT NOTICE

Texas Instruments Incorporated and its subsidiaries (TI) reserve the right to make corrections, enhancements, improvements and other changes to its semiconductor products and services per JESD46, latest issue, and to discontinue any product or service per JESD48, latest issue. Buyers should obtain the latest relevant information before placing orders and should verify that such information is current and complete. All semiconductor products (also referred to herein as "components") are sold subject to TI's terms and conditions of sale supplied at the time of order acknowledgment.

TI warrants performance of its components to the specifications applicable at the time of sale, in accordance with the warranty in TI's terms and conditions of sale of semiconductor products. Testing and other quality control techniques are used to the extent TI deems necessary to support this warranty. Except where mandated by applicable law, testing of all parameters of each component is not necessarily performed.

TI assumes no liability for applications assistance or the design of Buyers' products. Buyers are responsible for their products and applications using TI components. To minimize the risks associated with Buyers' products and applications, Buyers should provide adequate design and operating safeguards.

TI does not warrant or represent that any license, either express or implied, is granted under any patent right, copyright, mask work right, or other intellectual property right relating to any combination, machine, or process in which TI components or services are used. Information published by TI regarding third-party products or services does not constitute a license to use such products or services or a warranty or endorsement thereof. Use of such information may require a license from a third party under the patents or other intellectual property of the third party, or a license from TI under the patents or other intellectual property of TI.

Reproduction of significant portions of TI information in TI data books or data sheets is permissible only if reproduction is without alteration and is accompanied by all associated warranties, conditions, limitations, and notices. TI is not responsible or liable for such altered documentation. Information of third parties may be subject to additional restrictions.

Resale of TI components or services with statements different from or beyond the parameters stated by TI for that component or service voids all express and any implied warranties for the associated TI component or service and is an unfair and deceptive business practice. TI is not responsible or liable for any such statements.

Buyer acknowledges and agrees that it is solely responsible for compliance with all legal, regulatory and safety-related requirements concerning its products, and any use of TI components in its applications, notwithstanding any applications-related information or support that may be provided by TI. Buyer represents and agrees that it has all the necessary expertise to create and implement safeguards which anticipate dangerous consequences of failures, monitor failures and their consequences, lessen the likelihood of failures that might cause harm and take appropriate remedial actions. Buyer will fully indemnify TI and its representatives against any damages arising out of the use of any TI components in safety-critical applications.

In some cases, TI components may be promoted specifically to facilitate safety-related applications. With such components, TI's goal is to help enable customers to design and create their own end-product solutions that meet applicable functional safety standards and requirements. Nonetheless, such components are subject to these terms.

No TI components are authorized for use in FDA Class III (or similar life-critical medical equipment) unless authorized officers of the parties have executed a special agreement specifically governing such use.

Only those TI components which TI has specifically designated as military grade or "enhanced plastic" are designed and intended for use in military/aerospace applications or environments. Buyer acknowledges and agrees that any military or aerospace use of TI components which have **not** been so designated is solely at the Buyer's risk, and that Buyer is solely responsible for compliance with all legal and regulatory requirements in connection with such use.

TI has specifically designated certain components as meeting ISO/TS16949 requirements, mainly for automotive use. In any case of use of non-designated products, TI will not be responsible for any failure to meet ISO/TS16949.

Products

Audio	www.ti.com/audio
Amplifiers	amplifier.ti.com
Data Converters	dataconverter.ti.com
DLP® Products	www.dlp.com
DSP	dsp.ti.com
Clocks and Timers	www.ti.com/clocks
Interface	interface.ti.com
Logic	logic.ti.com
Power Mgmt	power.ti.com
Microcontrollers	microcontroller.ti.com
RFID	www.ti-rfid.com
OMAP Applications Processors	www.ti.com/omap
Wireless Connectivity	www.ti.com/wirelessconnectivity

Applications

Automotive and Transportation	www.ti.com/automotive
Communications and Telecom	www.ti.com/communications
Computers and Peripherals	www.ti.com/computers
Consumer Electronics	www.ti.com/consumer-apps
Energy and Lighting	www.ti.com/energy
Industrial	www.ti.com/industrial
Medical	www.ti.com/medical
Security	www.ti.com/security
Space, Avionics and Defense	www.ti.com/space-avionics-defense
Video and Imaging	www.ti.com/video

TI E2E Community

e2e.ti.com