

LOW-NOISE JFET-INPUT OPERATIONAL AMPLIFIER

 Check for Samples: [TL072-EP](#), [TL074-EP](#)

FEATURES

- Low Power Consumption
- Wide Common-Mode and Differential Voltage Ranges
- Low Input Bias and Offset Currents
- Output Short-Circuit Protection
- Low Total Harmonic Distortion: **0.003% Typ**
- Low Noise
 $V_n = 18 \text{ nV}/\sqrt{\text{Hz}}$ Typ at $f = 1 \text{ kHz}$
- High Input Impedance: JFET Input Stage
- Internal Frequency Compensation
- Latch-Up-Free Operation
- High Slew Rate: $13 \text{ V}/\mu\text{s}$ Typ
- Common-Mode Input Voltage Range Includes V_{CC+}

SUPPORTS DEFENSE, AEROSPACE, AND MEDICAL APPLICATIONS

- Controlled Baseline
- One Assembly and Test Site
- One Fabrication Site
- Available in Extended (-40°C to 125°C) or Military (-55°C to 125°C) Temperature Range
- Extended Product Life Cycle
- Extended Product-Change Notification
- Product Traceability

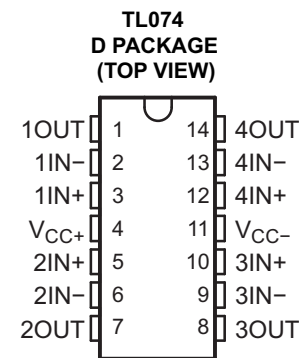
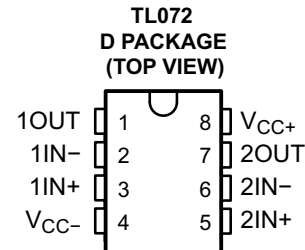

DESCRIPTION/ORDERING INFORMATION

The JFET-input operational amplifiers in the TL07x is similar to the TL08x series, with low input bias and offset currents and fast slew rate. The low harmonic distortion and low noise make the TL07x ideally suited for high-fidelity and audio preamplifier applications. Each amplifier features JFET inputs (for high input impedance) coupled with bipolar output stages integrated on a single monolithic chip.

The TL07x is characterized for operation over the extended temperature range of -40°C to 125°C or military temperature range of -55°C to 125°C .

ORDERING INFORMATION⁽¹⁾

T_A	$V_{IO\text{maX}}$ AT 25°C	PACKAGE		ORDERABLE PART NUMBER	TOP-SIDE MARKING	VID NUMBER
-40°C to 125°C	6 mV	SOIC – D	Reel of 2500	TL072QDREP	TL072Q	V62/12604-01XE
				TL074QDREP	TL074Q	V62/11621-01XE
-55°C to 125°C	6 mV	SOIC – D	Reel of 2500	TL074MDREP	TL074M	V62/11621-02XE
			Tube of 75	TL074MDEP	TL074M	V62/11621-02XE-T

(1) For the most current package and ordering information, see the Package Option Addendum at the end of this document, or see the TI website at www.ti.com.



Please be aware that an important notice concerning availability, standard warranty, and use in critical applications of Texas Instruments semiconductor products and disclaimers thereto appears at the end of this data sheet.

TL072 and TL074 SYMBOL (EACH AMPLIFIER)

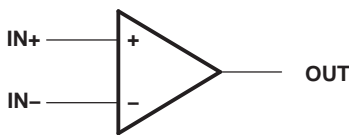

SCHEMATIC (EACH AMPLIFIER)

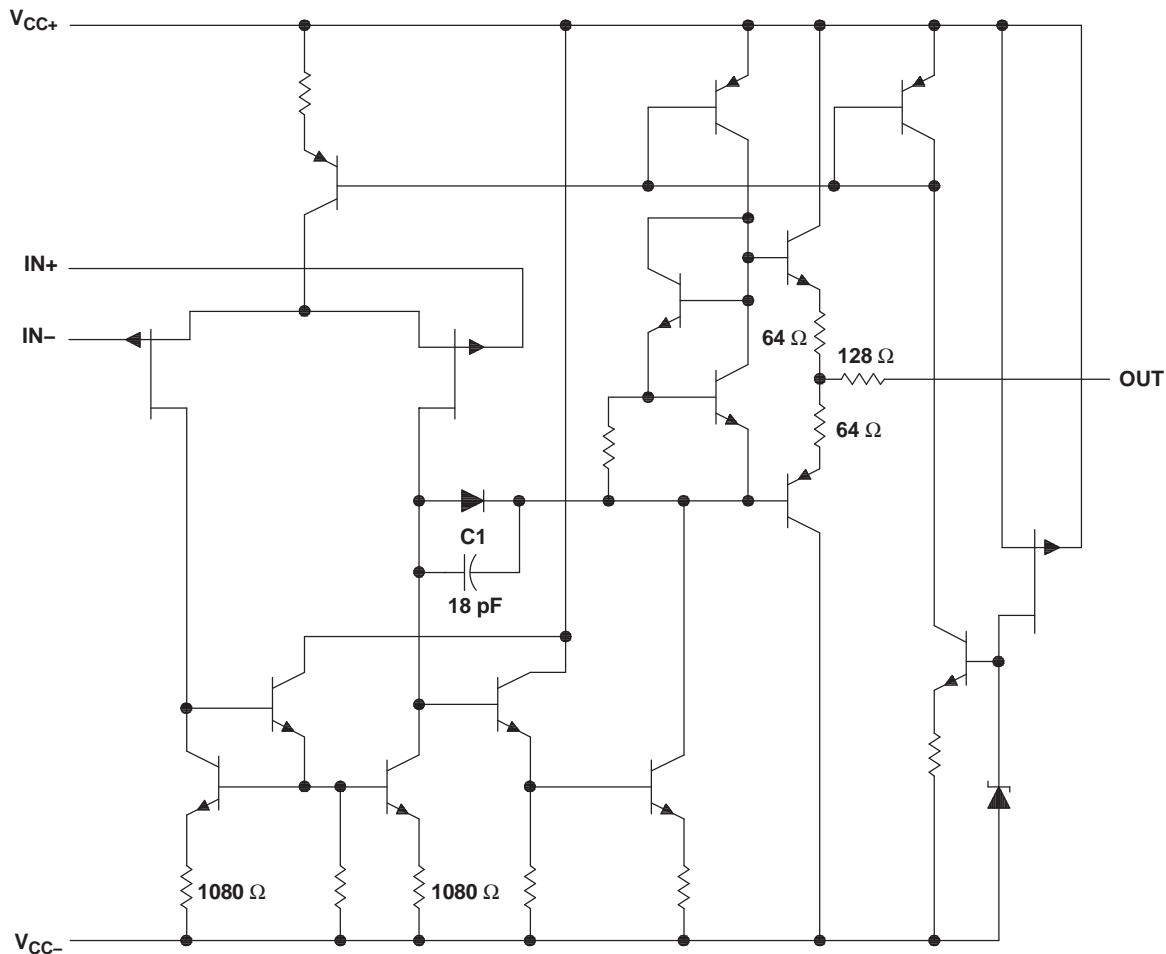

All component values shown are nominal.

COMPONENT COUNT ⁽¹⁾		
COMPONENT TYPE	TL072	TL074
Resistors	22	44
Transistors	28	56
JFET	4	6
Diodes	2	4
Capacitors	2	4
epi-FET	2	4

(1) Includes bias and trim circuitry

ABSOLUTE MAXIMUM RATINGS⁽¹⁾

over operating free-air temperature range (unless otherwise noted)

		MIN	MAX	UNIT
V _{CC+}	Supply voltage ⁽²⁾		18	V
V _{CC-}			18	
V _{ID}	Differential input voltage ⁽³⁾		±30	V
V _I	Input voltage ^{(2) (4)}		±15	V
	Duration of output short circuit ⁽⁵⁾		Unlimited	
θ _{JA}	Thermal resistance, junction-to-ambient ^{(6) (7)}	TL072	97.5	°C/W
		TL074	86	
θ _{JC}	Thermal resistance, junction-to-case ⁽⁷⁾	TL072	38.3	°C/W
		TL074	51.5	
T _J	Operating virtual junction temperature		150	°C
T _{stg}	Storage temperature range	-65	150	°C

- (1) Stresses beyond those listed under “absolute maximum ratings” may cause permanent damage to the device. These are stress ratings only, and functional operation of the device at these or any other conditions beyond those indicated under “recommended operating conditions” is not implied. Exposure to absolute-maximum-rated conditions for extended periods may affect device reliability.
- (2) All voltage values, except differential voltages, are with respect to the midpoint between V_{CC+} and V_{CC-}.
- (3) Differential voltages are at IN+, with respect to IN-.
- (4) The magnitude of the input voltage must never exceed the magnitude of the supply voltage or 15 V, whichever is less.
- (5) The output may be shorted to ground or to either supply. Temperature and/or supply voltages must be limited to ensure that the dissipation rating is not exceeded.
- (6) Operating at the absolute maximum T_J of 150°C can affect reliability.
- (7) The package thermal impedance is calculated in accordance with JESD 51-7.

ELECTRICAL CHARACTERISTICS

V_{CC±} = ±15 V (unless otherwise noted)

PARAMETER	TEST CONDITIONS ⁽¹⁾	T _A ⁽²⁾	TL072			TL074			UNIT	
			MIN	TYP	MAX	MIN	TYP	MAX		
V _{IO}	Input offset voltage	V _O = 0, R _S = 50 Ω	25°C		3	6	3		6	mV
			Full range				8		8	
α _{VIO}	Temperature coefficient of input offset voltage	V _O = 0, R _S = 50 Ω	Full range		18		18		μV/°C	
I _{IO}	Input offset current	V _O = 0	25°C		5	100	5		100	pA
			125°C				2		2	nA
I _{IB}	Input bias current	V _O = 0	25°C		65	200	65		200	pA
			125°C				20		20	nA
V _{ICR}	Common-mode input voltage range		25°C		±11	-12 to 15	±11		-12 to 15	V
V _{OM}	Maximum peak output voltage swing	R _L = 10 kΩ	25°C		±12	±13.5	±12		±13.5	V
		R _L ≥ 10 kΩ	Full range		±12		±12			
		R _L ≥ 2 kΩ	Full range		±10		±10			
A _{VD}	Large-signal differential voltage amplification	V _O = ±10 V, R _L ≥ 2 kΩ	25°C		35	200	35		200	V/mV
			Full range		15		15			
B ₁	Unity-gain bandwidth		25°C		3		3		MHz	
r _i	Input resistance		25°C		10 ¹²		10 ¹²		Ω	
CMRR	Common-mode rejection ratio	V _{IC} = V _{ICRmin} , V _O = 0, R _S = 50 Ω	25°C		80	86	80		86	dB
k _{SVR}	Supply-voltage rejection ratio (ΔV _{CC±} /ΔV _{IO})	V _{CC} = ±9 V to ±15 V, V _O = 0, R _S = 50 Ω	25°C		80	86	80		86	dB
I _{CC}	Supply current (each amplifier)	V _O = 0, No load	25°C		1.4	2.5	1.4		2.5	mA
V _{O1} /V _{O2}	Crosstalk attenuation	A _{VD} = 100	25°C		120		120		dB	

- Input bias currents of an FET-input operational amplifier are normal junction reverse currents, which are temperature sensitive, as shown in Figure 3. Pulse techniques must be used that will maintain the junction temperature as close to the ambient temperature as possible.
- All characteristics are measured under open-loop conditions with zero common-mode voltage, unless otherwise specified. Full range is T_A = -40°C to 125°C for TL07xQ and T_A = -55°C to 125°C for TL07xM.

OPERATING CHARACTERISTICS

V_{CC±} = ±15 V, T_A = 25°C

PARAMETER	TEST CONDITIONS		TL072			TL074			UNIT
			MIN	TYP	MAX	MIN	TYP	MAX	
SR	Slew rate at unity gain	V _I = 10 V, C _L = 100 pF, R _L = 2 kΩ, See Figure 1	8	13		8	13		V/μs
t _r	Rise-time overshoot factor	V _I = 20 V, C _L = 100 pF, R _L = 2 kΩ, See Figure 1			0.1			0.1	μs
					20			20	%
V _n	Equivalent input noise voltage	R _S = 20 Ω	f = 1 kHz		18			18	nV/√Hz
			f = 10 Hz to 10 kHz		4			4	μV
I _n	Equivalent input noise current	R _S = 20 Ω, f = 1 kHz			0.01			0.01	pA/√Hz
THD	Total harmonic distortion	V _{I rms} = 6 V, R _L ≥ 2 kΩ, f = 1 kHz, A _{VD} = 1, R _S ≤ 1 kΩ,			0.003			0.003	%

PARAMETER MEASUREMENT INFORMATION

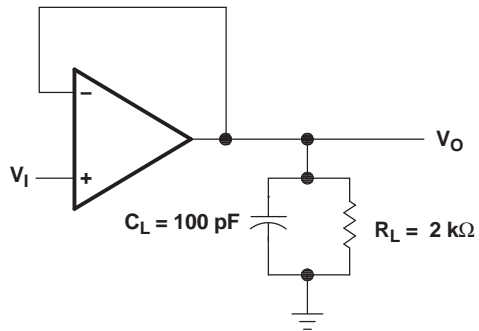

Figure 1. Unity-Gain Amplifier

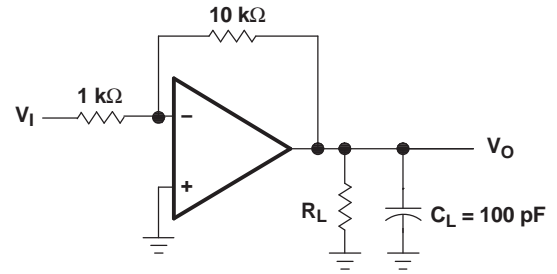
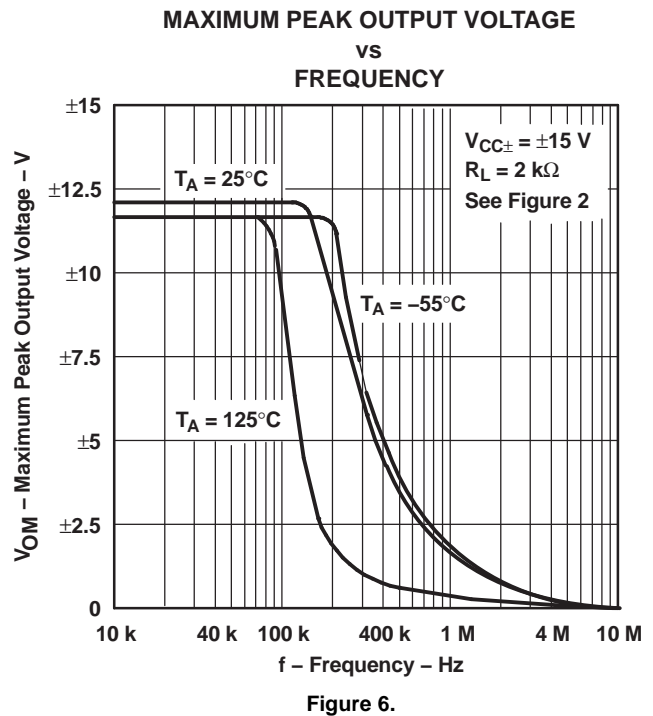
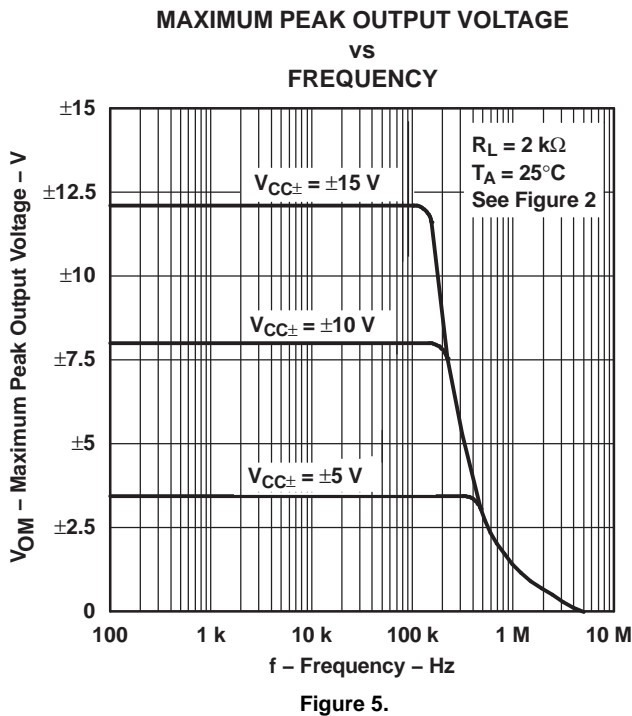
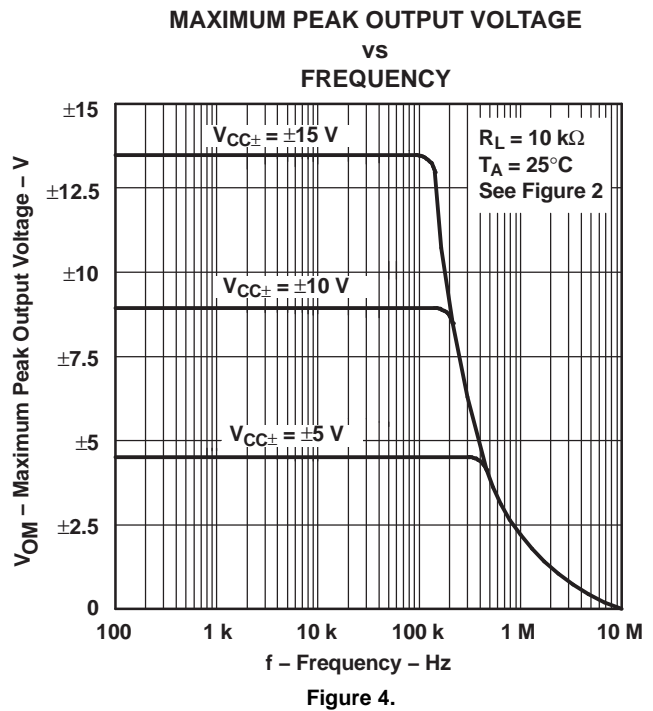
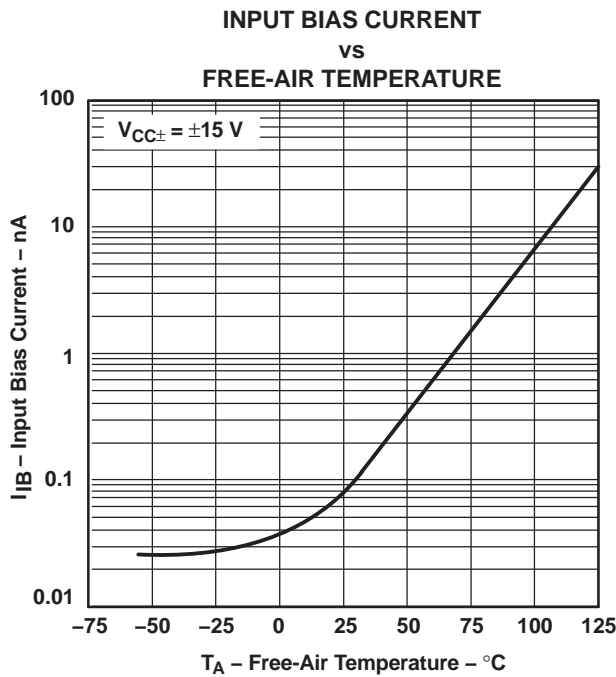

Figure 2. Gain-of-10 Inverting Amplifier

TYPICAL CHARACTERISTICS

Data at high and low temperatures are applicable only within the rated operating free-air temperature ranges of the various devices.



TYPICAL CHARACTERISTICS (continued)

Data at high and low temperatures are applicable only within the rated operating free-air temperature ranges of the various devices.

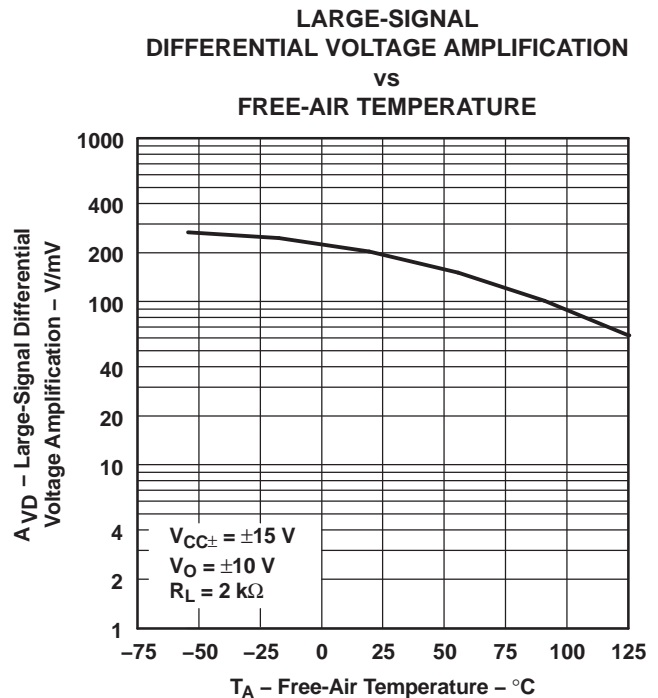
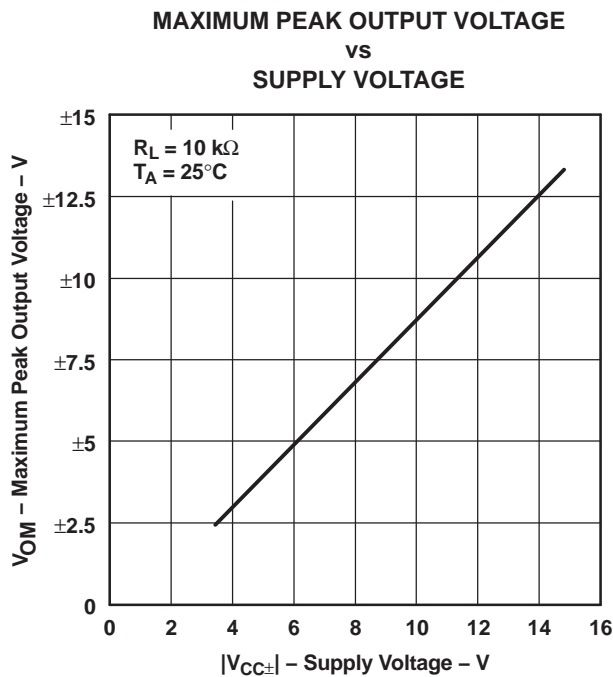
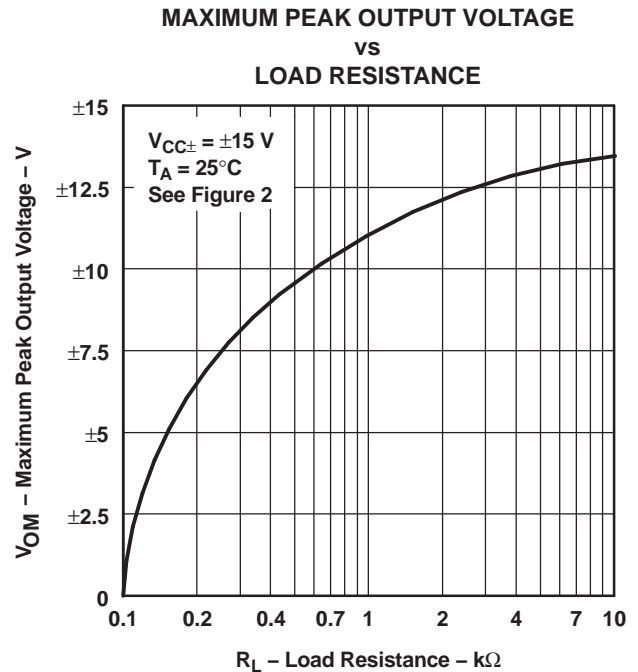
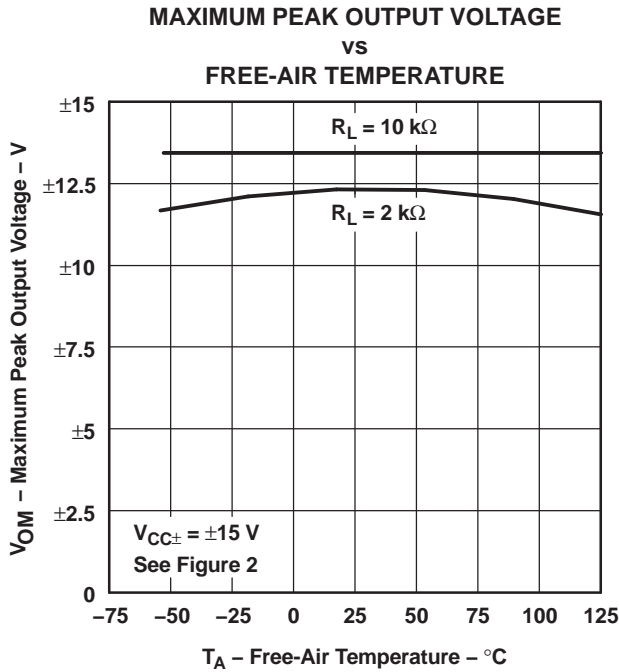

TYPICAL CHARACTERISTICS (continued)

Data at high and low temperatures are applicable only within the rated operating free-air temperature ranges of the various devices.

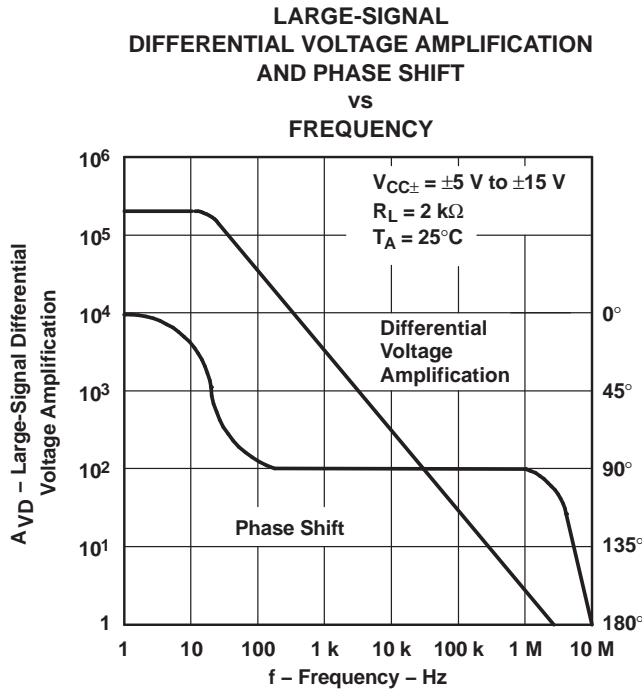

Figure 11.

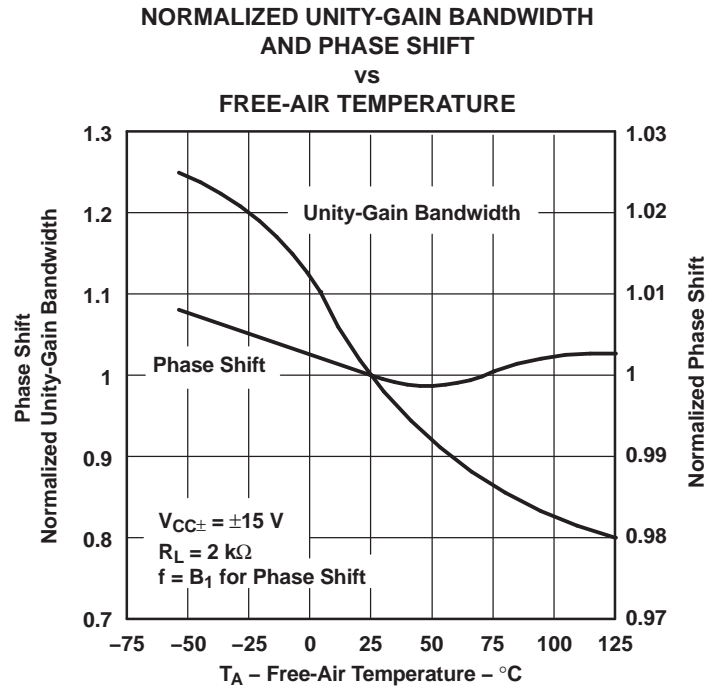

Figure 12.

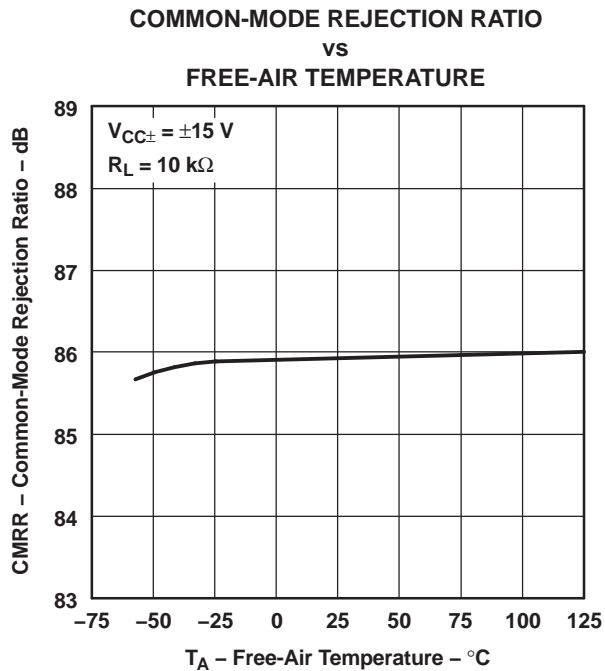

Figure 13.

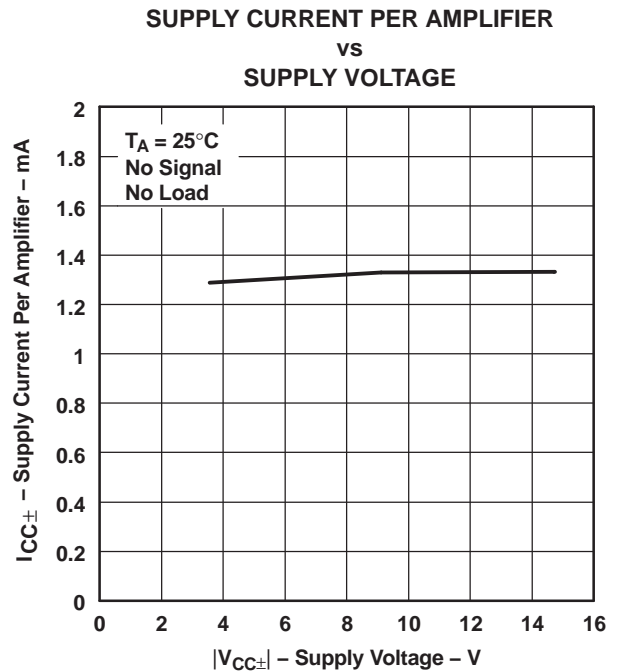

Figure 14.

TYPICAL CHARACTERISTICS (continued)

Data at high and low temperatures are applicable only within the rated operating free-air temperature ranges of the various devices.

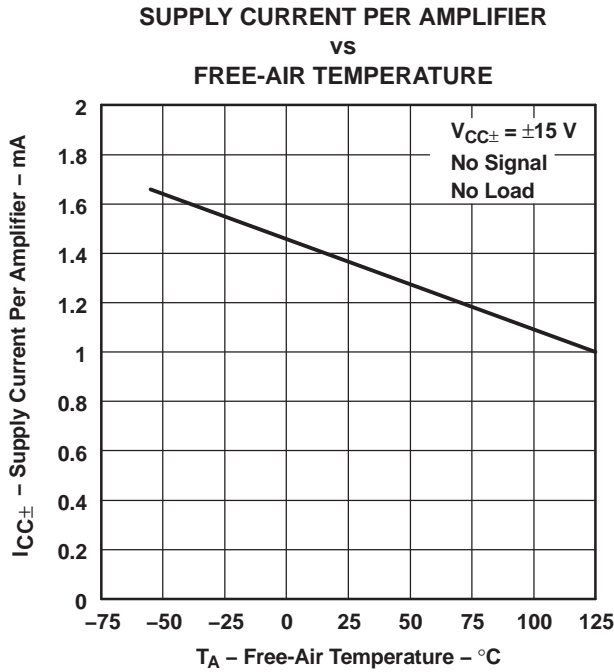

Figure 15.

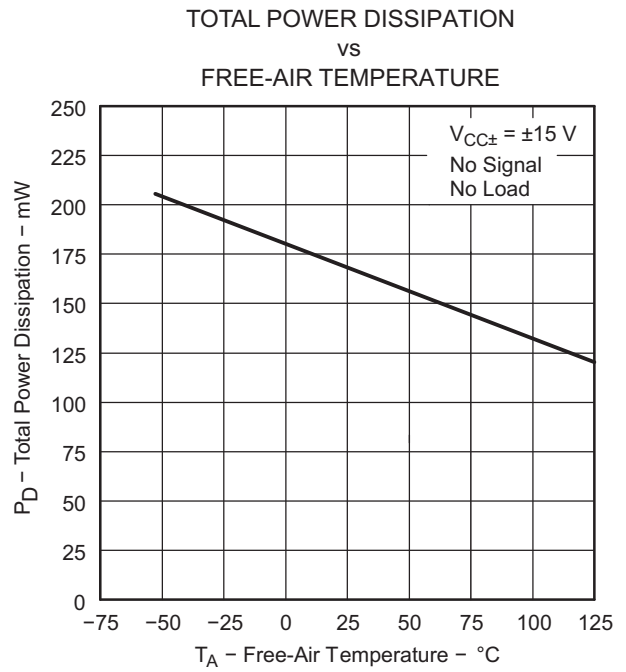

Figure 16.

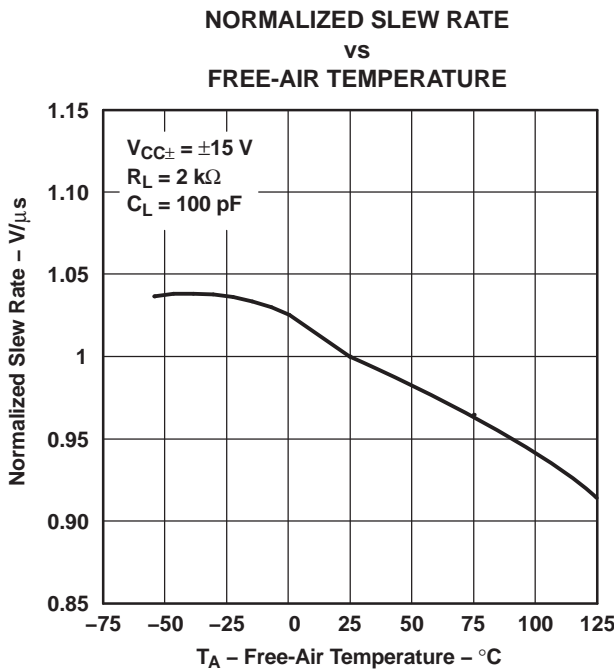

Figure 17.

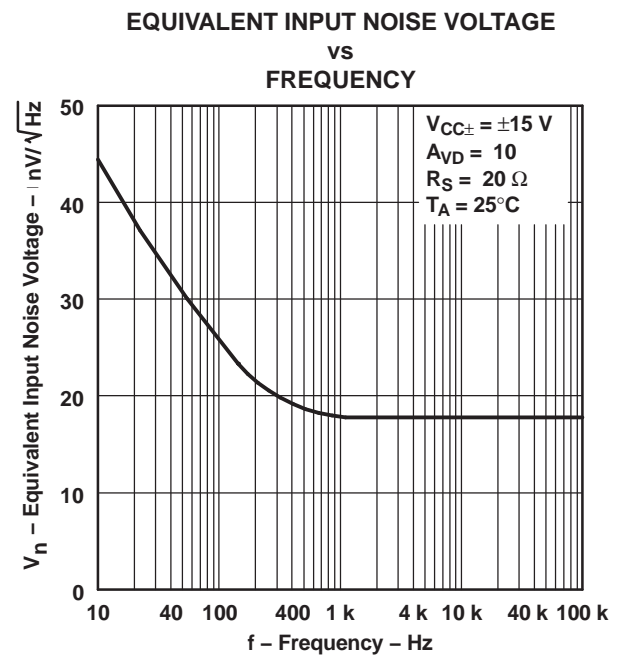

Figure 18.

TYPICAL CHARACTERISTICS (continued)

Data at high and low temperatures are applicable only within the rated operating free-air temperature ranges of the various devices.

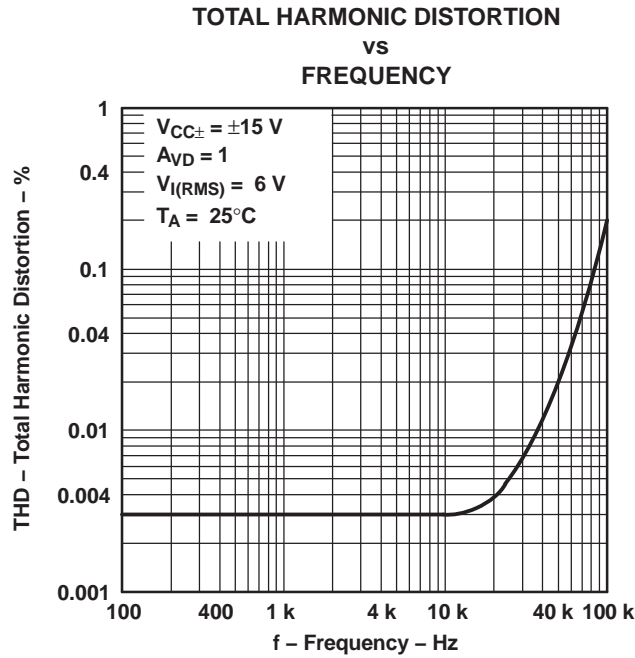

Figure 19.

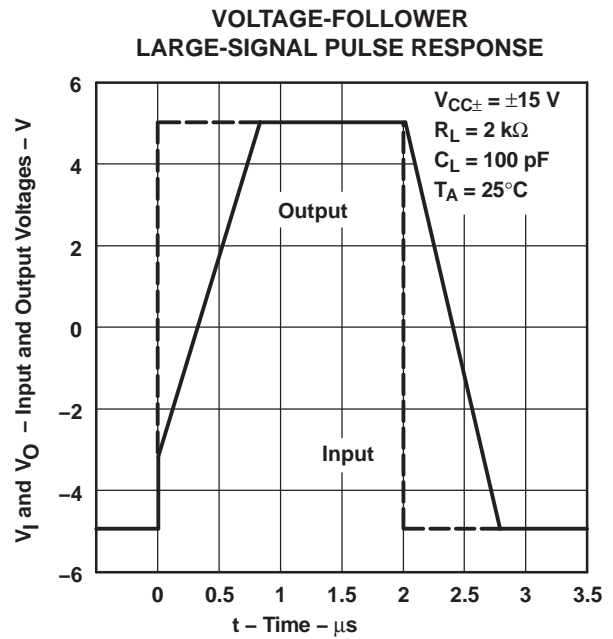

Figure 20.

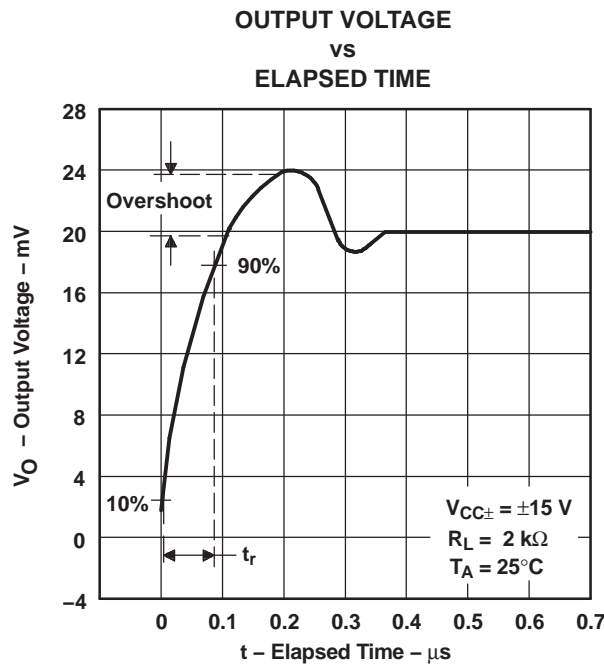
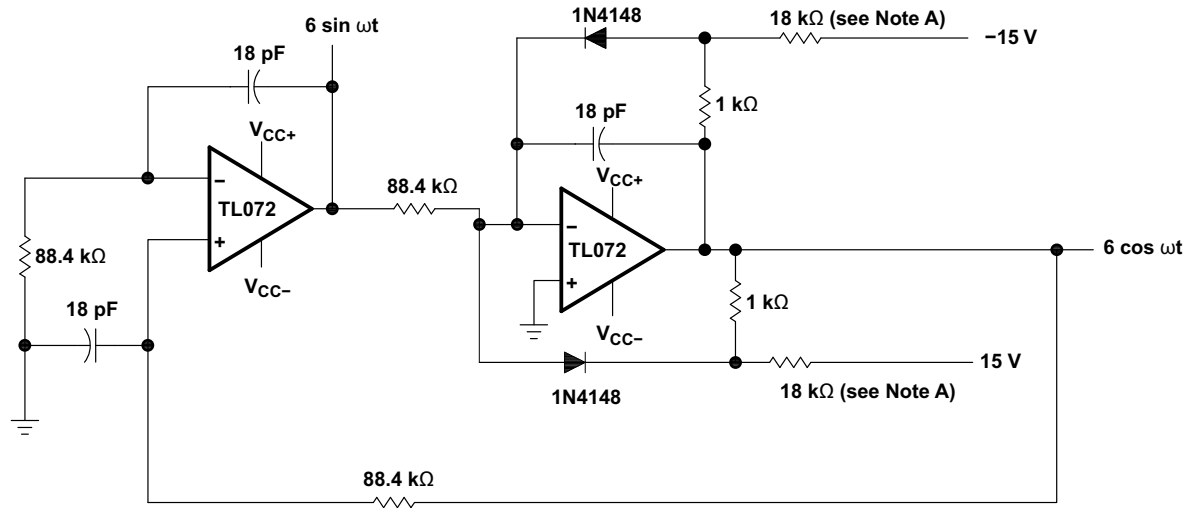

Figure 21.

APPLICATION INFORMATION



NOTE A: These resistor values may be adjusted for a symmetrical output.

Figure 22. 100-kHz Quadrature Oscillator

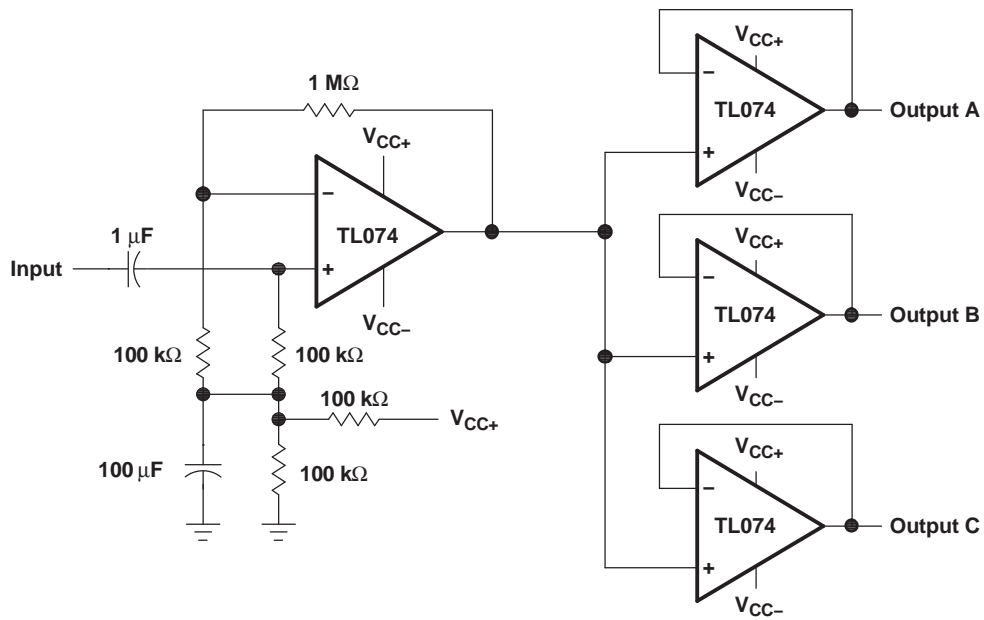

Figure 23. Audio-Distribution Amplifier

PACKAGING INFORMATION

Orderable Device	Status (1)	Package Type	Package Drawing	Pins	Package Qty	Eco Plan (2)	Lead/Ball Finish (6)	MSL Peak Temp (3)	Op Temp (°C)	Device Marking (4/5)	Samples
TL072QDREP	ACTIVE	SOIC	D	8	2500	Green (RoHS & no Sb/Br)	NIPDAU	Level-1-260C-UNLIM	-40 to 125	TL072Q	Samples
TL074MDEP	ACTIVE	SOIC	D	14	50	Green (RoHS & no Sb/Br)	NIPDAU	Level-1-260C-UNLIM	-55 to 125	TL074M	Samples
TL074MDREP	ACTIVE	SOIC	D	14	2500	Green (RoHS & no Sb/Br)	NIPDAU	Level-1-260C-UNLIM	-55 to 125	TL074M	Samples
TL074QDREP	ACTIVE	SOIC	D	14	2500	Green (RoHS & no Sb/Br)	NIPDAU	Level-1-260C-UNLIM	-40 to 125	TL074Q	Samples
V62/11621-01XE	ACTIVE	SOIC	D	14	2500	Green (RoHS & no Sb/Br)	NIPDAU	Level-1-260C-UNLIM	-40 to 125	TL074Q	Samples
V62/11621-02XE	ACTIVE	SOIC	D	14	2500	Green (RoHS & no Sb/Br)	NIPDAU	Level-1-260C-UNLIM	-55 to 125	TL074M	Samples
V62/11621-02XE-T	ACTIVE	SOIC	D	14	50	Green (RoHS & no Sb/Br)	NIPDAU	Level-1-260C-UNLIM	-55 to 125	TL074M	Samples
V62/12604-01XE	ACTIVE	SOIC	D	8	2500	Green (RoHS & no Sb/Br)	NIPDAU	Level-1-260C-UNLIM	-40 to 125	TL072Q	Samples

(1) The marketing status values are defined as follows:

ACTIVE: Product device recommended for new designs.

LIFEBUY: TI has announced that the device will be discontinued, and a lifetime-buy period is in effect.

NRND: Not recommended for new designs. Device is in production to support existing customers, but TI does not recommend using this part in a new design.

PREVIEW: Device has been announced but is not in production. Samples may or may not be available.

OBSOLETE: TI has discontinued the production of the device.

(2) **RoHS:** TI defines "RoHS" to mean semiconductor products that are compliant with the current EU RoHS requirements for all 10 RoHS substances, including the requirement that RoHS substance do not exceed 0.1% by weight in homogeneous materials. Where designed to be soldered at high temperatures, "RoHS" products are suitable for use in specified lead-free processes. TI may reference these types of products as "Pb-Free".

RoHS Exempt: TI defines "RoHS Exempt" to mean products that contain lead but are compliant with EU RoHS pursuant to a specific EU RoHS exemption.

Green: TI defines "Green" to mean the content of Chlorine (Cl) and Bromine (Br) based flame retardants meet JS709B low halogen requirements of <=100ppm threshold. Antimony trioxide based flame retardants must also meet the <=1000ppm threshold requirement.

(3) MSL, Peak Temp. - The Moisture Sensitivity Level rating according to the JEDEC industry standard classifications, and peak solder temperature.

(4) There may be additional marking, which relates to the logo, the lot trace code information, or the environmental category on the device.

(5) Multiple Device Markings will be inside parentheses. Only one Device Marking contained in parentheses and separated by a "-" will appear on a device. If a line is indented then it is a continuation of the previous line and the two combined represent the entire Device Marking for that device.

(6) Lead/Ball Finish - Orderable Devices may have multiple material finish options. Finish options are separated by a vertical ruled line. Lead/Ball Finish values may wrap to two lines if the finish value exceeds the maximum column width.

Important Information and Disclaimer:The information provided on this page represents TI's knowledge and belief as of the date that it is provided. TI bases its knowledge and belief on information provided by third parties, and makes no representation or warranty as to the accuracy of such information. Efforts are underway to better integrate information from third parties. TI has taken and continues to take reasonable steps to provide representative and accurate information but may not have conducted destructive testing or chemical analysis on incoming materials and chemicals. TI and TI suppliers consider certain information to be proprietary, and thus CAS numbers and other limited information may not be available for release.

In no event shall TI's liability arising out of such information exceed the total purchase price of the TI part(s) at issue in this document sold by TI to Customer on an annual basis.

OTHER QUALIFIED VERSIONS OF TL072-EP, TL074-EP :

- Catalog: [TL072](#), [TL074](#)
- Military: [TL072M](#), [TL074M](#)

NOTE: Qualified Version Definitions:

- Catalog - TI's standard catalog product
- Military - QML certified for Military and Defense Applications

TAPE AND REEL INFORMATION



QUADRANT ASSIGNMENTS FOR PIN 1 ORIENTATION IN TAPE



*All dimensions are nominal

Device	Package Type	Package Drawing	Pins	SPQ	Reel Diameter (mm)	Reel Width W1 (mm)	A0 (mm)	B0 (mm)	K0 (mm)	P1 (mm)	W (mm)	Pin1 Quadrant
TL072QDREP	SOIC	D	8	2500	330.0	12.5	6.4	5.2	2.1	8.0	12.0	Q1
TL074MDREP	SOIC	D	14	2500	330.0	16.4	6.5	9.0	2.1	8.0	16.0	Q1
TL074QDREP	SOIC	D	14	2500	330.0	16.4	6.5	9.0	2.1	8.0	16.0	Q1

TAPE AND REEL BOX DIMENSIONS

*All dimensions are nominal

Device	Package Type	Package Drawing	Pins	SPQ	Length (mm)	Width (mm)	Height (mm)
TL072QDREP	SOIC	D	8	2500	340.5	338.1	20.6
TL074MDREP	SOIC	D	14	2500	333.2	345.9	28.6
TL074QDREP	SOIC	D	14	2500	333.2	345.9	28.6

D (R-PDSO-G14)

PLASTIC SMALL OUTLINE



- NOTES:
- A. All linear dimensions are in inches (millimeters).
 - B. This drawing is subject to change without notice.
 -  Body length does not include mold flash, protrusions, or gate burrs. Mold flash, protrusions, or gate burrs shall not exceed 0.006 (0,15) each side.
 -  Body width does not include interlead flash. Interlead flash shall not exceed 0.017 (0,43) each side.
 - E. Reference JEDEC MS-012 variation AB.

D (R-PDSO-G14)

PLASTIC SMALL OUTLINE



- NOTES:
- A. All linear dimensions are in millimeters.
 - B. This drawing is subject to change without notice.
 - C. Publication IPC-7351 is recommended for alternate designs.
 - D. Laser cutting apertures with trapezoidal walls and also rounding corners will offer better paste release. Customers should contact their board assembly site for stencil design recommendations. Refer to IPC-7525 for other stencil recommendations.
 - E. Customers should contact their board fabrication site for solder mask tolerances between and around signal pads.



D0008A

PACKAGE OUTLINE

SOIC - 1.75 mm max height

SMALL OUTLINE INTEGRATED CIRCUIT



4214825/C 02/2019

NOTES:

- Linear dimensions are in inches [millimeters]. Dimensions in parenthesis are for reference only. Controlling dimensions are in inches. Dimensioning and tolerancing per ASME Y14.5M.
- This drawing is subject to change without notice.
- This dimension does not include mold flash, protrusions, or gate burrs. Mold flash, protrusions, or gate burrs shall not exceed $.006$ [0.15] per side.
- This dimension does not include interlead flash.
- Reference JEDEC registration MS-012, variation AA.

EXAMPLE BOARD LAYOUT

D0008A

SOIC - 1.75 mm max height

SMALL OUTLINE INTEGRATED CIRCUIT



LAND PATTERN EXAMPLE
 EXPOSED METAL SHOWN
 SCALE:8X



SOLDER MASK DETAILS

4214825/C 02/2019

NOTES: (continued)

- 6. Publication IPC-7351 may have alternate designs.
- 7. Solder mask tolerances between and around signal pads can vary based on board fabrication site.

EXAMPLE STENCIL DESIGN

D0008A

SOIC - 1.75 mm max height

SMALL OUTLINE INTEGRATED CIRCUIT



SOLDER PASTE EXAMPLE
BASED ON .005 INCH [0.125 MM] THICK STENCIL
SCALE:8X

4214825/C 02/2019

NOTES: (continued)

8. Laser cutting apertures with trapezoidal walls and rounded corners may offer better paste release. IPC-7525 may have alternate design recommendations.
9. Board assembly site may have different recommendations for stencil design.

IMPORTANT NOTICE AND DISCLAIMER

TI PROVIDES TECHNICAL AND RELIABILITY DATA (INCLUDING DATASHEETS), DESIGN RESOURCES (INCLUDING REFERENCE DESIGNS), APPLICATION OR OTHER DESIGN ADVICE, WEB TOOLS, SAFETY INFORMATION, AND OTHER RESOURCES "AS IS" AND WITH ALL FAULTS, AND DISCLAIMS ALL WARRANTIES, EXPRESS AND IMPLIED, INCLUDING WITHOUT LIMITATION ANY IMPLIED WARRANTIES OF MERCHANTABILITY, FITNESS FOR A PARTICULAR PURPOSE OR NON-INFRINGEMENT OF THIRD PARTY INTELLECTUAL PROPERTY RIGHTS.

These resources are intended for skilled developers designing with TI products. You are solely responsible for (1) selecting the appropriate TI products for your application, (2) designing, validating and testing your application, and (3) ensuring your application meets applicable standards, and any other safety, security, or other requirements. These resources are subject to change without notice. TI grants you permission to use these resources only for development of an application that uses the TI products described in the resource. Other reproduction and display of these resources is prohibited. No license is granted to any other TI intellectual property right or to any third party intellectual property right. TI disclaims responsibility for, and you will fully indemnify TI and its representatives against, any claims, damages, costs, losses, and liabilities arising out of your use of these resources.

TI's products are provided subject to TI's Terms of Sale (www.ti.com/legal/termsofsale.html) or other applicable terms available either on ti.com or provided in conjunction with such TI products. TI's provision of these resources does not expand or otherwise alter TI's applicable warranties or warranty disclaimers for TI products.

Mailing Address: Texas Instruments, Post Office Box 655303, Dallas, Texas 75265
Copyright © 2020, Texas Instruments Incorporated