

IGBT - Field Stop, Trench

700 V, 40 A

FGH40T70SHD

Description

Using novel field stop IGBT technology, ON Semiconductor's new series of field stop 3rd generation IGBTs offer the optimum performance for Solar Inverter, UPS, Welder, Telecom, ESS and PFC applications where low conduction and switching losses are essential.

Features

- Maximum Junction Temperature : $T_J = 175^\circ\text{C}$
- Positive Temperature Co-efficient for Easy Parallel Operating
- High Current Capability
- Low Saturation Voltage: $V_{CE(sat)} = 1.7\text{ V(Typ.)} @ I_C = 40\text{ A}$
- 100% of the Parts Tested for $I_{LM}(1)$
- High Input Impedance
- Fast Switching
- Tighten Parameter Distribution
- These Devices are Pb-Free and are RoHS Compliant

Applications

- Solar Inverter, UPS, Welder, Telecom, ESS, PFC



ON Semiconductor®

www.onsemi.com



TO-247-3LD
CASE 340CH

MARKING DIAGRAM

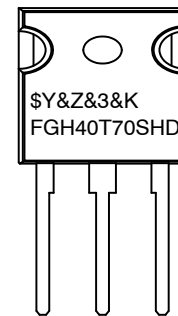

\$Y = ON Semiconductor Logo
&Z = Assembly Plant Code
&3 = Numeric Date Code
&K = Lot Code
FGH40T70SHD = Specific Device Code

ORDERING INFORMATION

See detailed ordering and shipping information in the package dimensions section on page 2 of this data sheet.

FGH40T70SHD

ABSOLUTE MAXIMUM RATINGS (T_C = 25°C unless otherwise noted)

Description		Symbol	Rating	Unit
Collector to Emitter Voltage		V _{CES}	700	V
Gate to Emitter Voltage		V _{GES}	±20	V
Transient Gate to Emitter Voltage			±30	V
Collector Current	T _C = 25°C	I _C	80	A
Collector Current	T _C = 100°C		40	A
Pulsed Collector Current	T _C = 25°C	I _{LM} (Note 1)	120	A
Pulsed Collector Current		I _{CM} (Note 2)	120	A
Diode Forward Current	T _C = 25°C	I _F	40	A
Diode Forward Current	T _C = 100°C		20	A
Pulsed Diode Maximum Forward Current		I _{FM} (Note 2)	120	A
Maximum Power Dissipation	T _C = 25°C	P _D	268	W
Maximum Power Dissipation	T _C = 100°C		134	W
Operating Junction Temperature		T _J	-55 to +175	°C
Storage Temperature Range		T _{stg}	-55 to +175	°C
Maximum Lead Temp. for soldering Purposes, 1/8" from case for 5 seconds		T _L	300	°C

Stresses exceeding those listed in the Maximum Ratings table may damage the device. If any of these limits are exceeded, device functionality should not be assumed, damage may occur and reliability may be affected.

- V_{CC} = 400 V, V_{GE} = 15 V, I_C = 120 A, R_G = 30 Ω, Inductive Load
- Repetitive rating: Pulse width limited by max. junction temperature.

THERMAL CHARACTERISTICS

Parameter	Symbol	Typ	Max	Unit
Thermal Resistance, Junction to Case	R _{θJC} (IGBT)	-	0.56	°C/W
Thermal Resistance, Junction to Case	R _{θJC} (Diode)	-	1.71	°C/W
Thermal Resistance, Junction to Ambient	R _{θJA}	-	40	°C/W

PACKAGE MARKING AND ORDERING INFORMATION

Part Number	Top Mark	Package	Packing Method	Reel Size	Tape Width	Quantity
FGH40T70SHD-F155	FGH40T70SHD	TO-247-3 (Pb-Free)	Tube	-	-	30

ELECTRICAL CHARACTERISTICS OF THE IGBT (T_C = 25°C unless otherwise noted)

Parameter	Symbol	Test Conditions	Min	Typ	Max	Unit
-----------	--------	-----------------	-----	-----	-----	------

OFF CHARACTERISTICS

Collector to Emitter Breakdown Voltage	BV _{CES}	V _{GE} = 0 V, I _C = 250 μA	700	-	-	V
Temperature Coefficient of Breakdown Voltage	ΔBV _{CES} /ΔT _J	I _C = 1 mA, Reference to 25°C	-	0.6	-	V/°C
Collector Cut-Off Current	I _{CES}	V _{CE} = V _{CES} , V _{GE} = 0 V	-	-	250	μA
G-E Leakage Current	I _{GES}	V _{GE} = V _{GES} , V _{CE} = 0 V	-	-	±400	nA

ON CHARACTERISTICS

G-E Threshold Voltage	V _{GE(th)}	I _C = 40 mA, V _{CE} = V _{GE}	4.0	5.5	7.5	V
Collector to Emitter Saturation Voltage	V _{CE(sat)}	I _C = 40 A, V _{GE} = 15 V	-	1.7	2.15	V
		I _C = 40 A, V _{GE} = 15 V, T _C = 175°C	-	2.37	-	V

FGH40T70SHD

ELECTRICAL CHARACTERISTICS OF THE IGBT ($T_C = 25^\circ\text{C}$ unless otherwise noted) (continued)

Parameter	Symbol	Test Conditions	Min	Typ	Max	Unit
-----------	--------	-----------------	-----	-----	-----	------

DYNAMIC CHARACTERISTICS

Input Capacitance	C_{ies}	$V_{CE} = 30\text{ V}, V_{GE} = 0\text{ V}, f = 1\text{ MHz}$	-	2028	-	pF
Output Capacitance	C_{oes}		-	75	-	pF
Reverse Transfer Capacitance	C_{res}		-	26	-	pF

SWITCHING CHARACTERISTICS

Turn-On Delay Time	$t_{d(on)}$	$V_{CC} = 400\text{ V}, I_C = 40\text{ A},$ $R_G = 6\ \Omega, V_{GE} = 15\text{ V},$ Inductive Load, $T_C = 25^\circ\text{C}$	-	22	-	ns
Rise Time	t_r		-	40	-	ns
Turn-Off Delay Time	$t_{d(off)}$		-	66	-	ns
Fall Time	t_f		-	10	-	ns
Turn-On Switching Loss	E_{on}		-	1150	-	μJ
Turn-Off Switching Loss	E_{off}		-	271	-	μJ
Total Switching Loss	E_{ts}		-	1421	-	μJ
Turn-On Delay Time	$t_{d(on)}$	$V_{CC} = 400\text{ V}, I_C = 40\text{ A},$ $R_G = 6\ \Omega, V_{GE} = 15\text{ V},$ Inductive Load, $T_C = 175^\circ\text{C}$	-	20	-	ns
Rise Time	t_r		-	36	-	ns
Turn-Off Delay Time	$t_{d(off)}$		-	68	-	ns
Fall Time	t_f		-	13	-	ns
Turn-On Switching Loss	E_{on}		-	1760	-	μJ
Turn-Off Switching Loss	E_{off}		-	455	-	μJ
Total Switching Loss	E_{ts}		-	2215	-	μJ
Total Gate Charge	Q_g	$V_{CE} = 400\text{ V}, I_C = 40\text{ A}, V_{GE} = 15\text{ V}$	-	69	-	nC
Gate to Emitter Charge	Q_{ge}		-	13	-	nC
Gate to Collector Charge	Q_{gc}		-	26	-	nC

ELECTRICAL CHARACTERISTICS OF THE DIODE ($T_J = 25^\circ\text{C}$ unless otherwise noted)

Parameter	Symbol	Test Conditions	Min	Typ	Max	Unit	
Diode Forward Voltage	V_{FM}	$I_F = 20\text{ A}$	$T_C = 25^\circ\text{C}$	-	2.0	2.5	V
			$T_C = 175^\circ\text{C}$	-	1.73	-	
Reverse Recovery Energy	E_{rec}	$I_F = 20\text{ A}, di_F/dt = 200\text{ A}/\mu\text{s}$	$T_C = 175^\circ\text{C}$	-	54	-	μJ
Diode Reverse Recovery Time	t_{rr}		$T_C = 25^\circ\text{C}$	-	37	-	ns
			$T_C = 175^\circ\text{C}$	-	235	-	ns
Diode Reverse Recovery Charge	Q_{rr}		$T_C = 25^\circ\text{C}$	-	65	-	nC
		$T_C = 175^\circ\text{C}$	-	944	-	nC	

TYPICAL PERFORMANCE CHARACTERISTICS

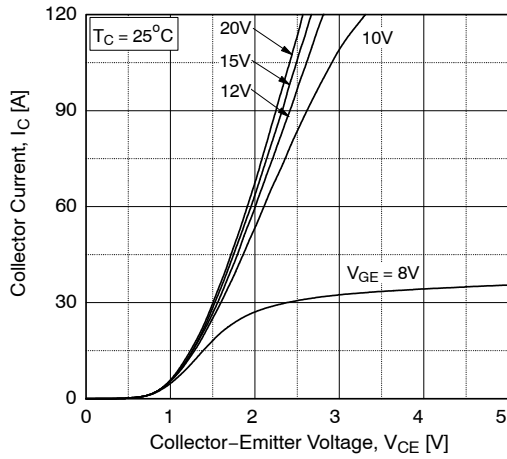

Figure 1. Typical Output Characteristics

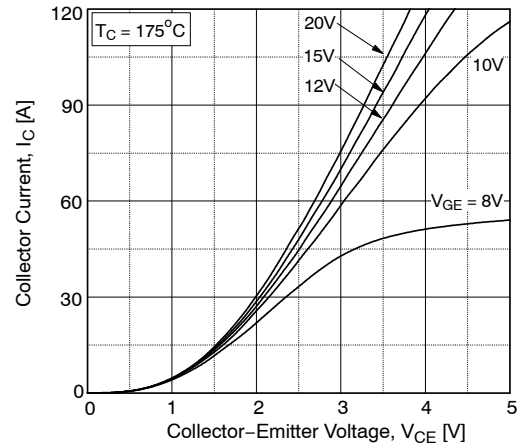

Figure 2. Typical Output Characteristics

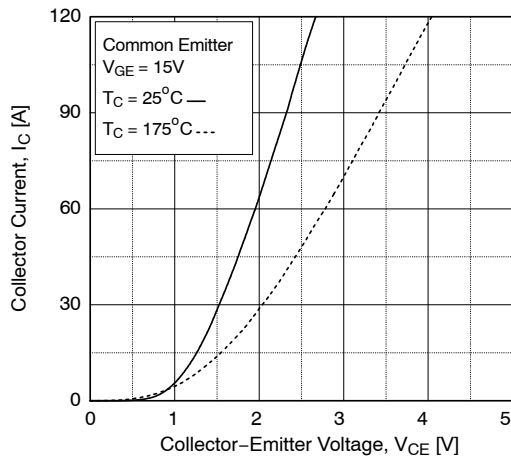

Figure 3. Typical Saturation Voltage Characteristics

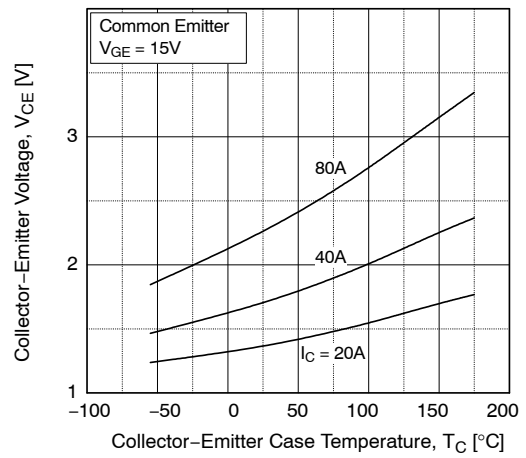

Figure 4. Saturation Voltage vs. Case Temperature at Variant Current Level

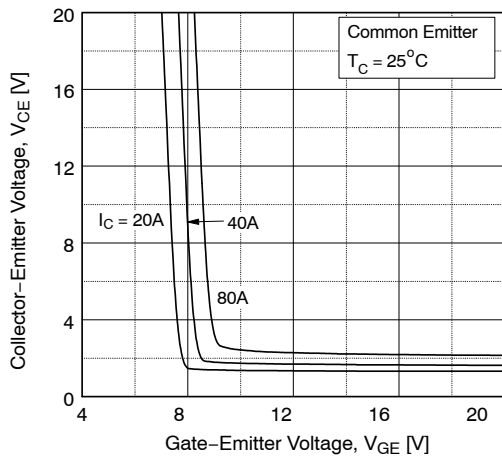

Figure 5. Saturation Voltage vs Vge

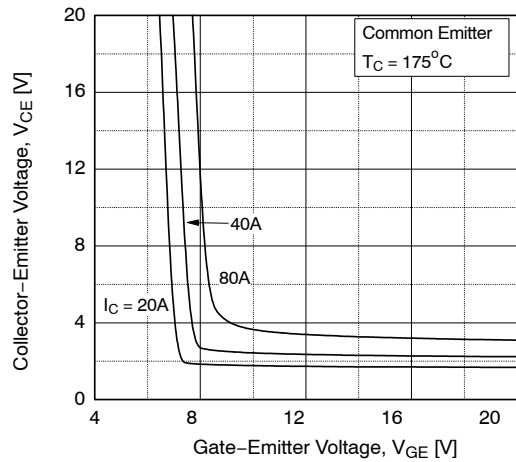

Figure 6. Saturation Voltage vs Vge

TYPICAL PERFORMANCE CHARACTERISTICS

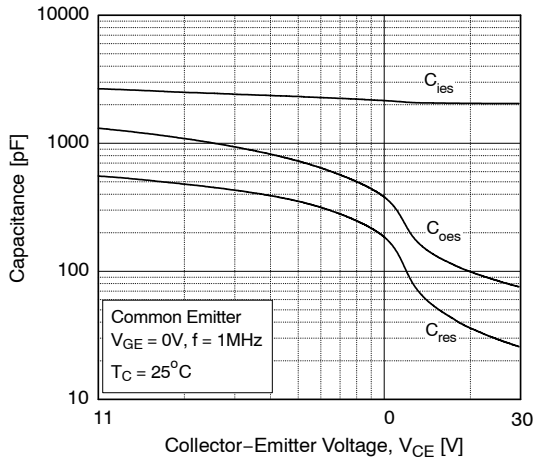

Figure 7. Capacitance Characteristics

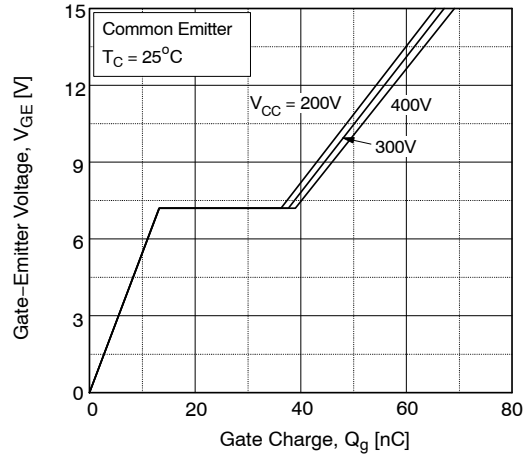

Figure 8. Gate Charge Characteristic

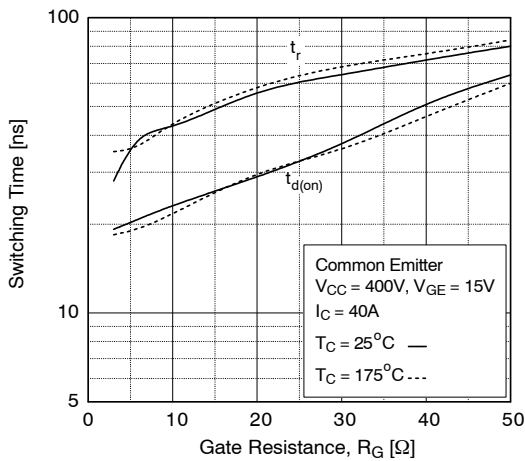

Figure 9. Turn-On Characteristics vs. Gate Resistance

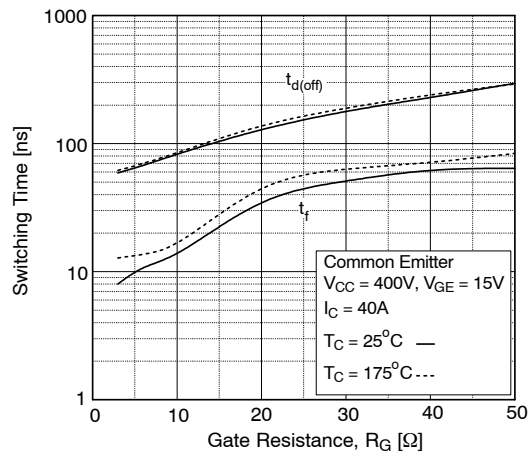

Figure 10. Turn-Off Characteristics vs. Gate Resistance

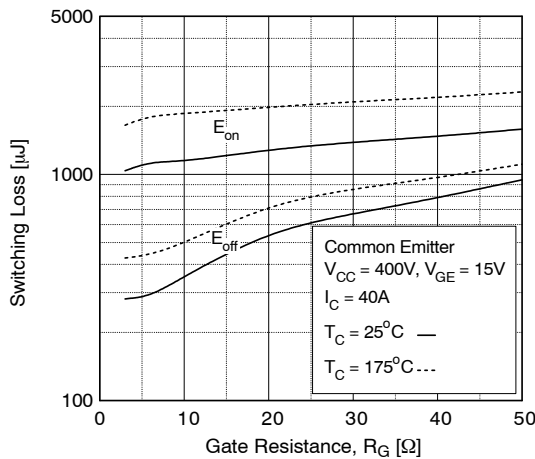

Figure 11. Switching Loss vs. Gate Resistance

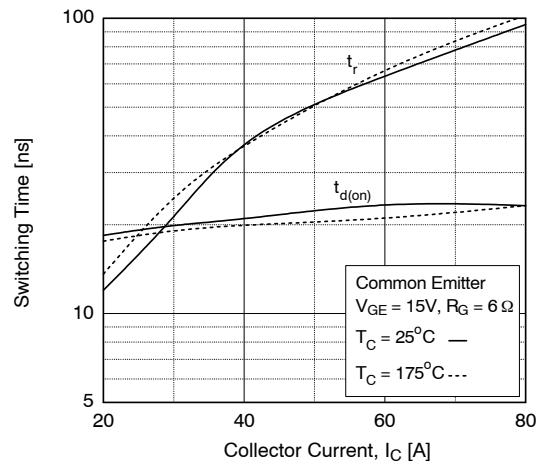

Figure 12. Turn-On Characteristics vs. Collector Current

FGH40T70SHD

TYPICAL PERFORMANCE CHARACTERISTICS

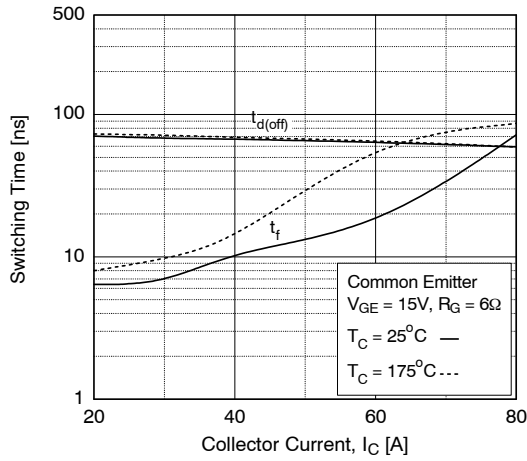

Figure 13. Turn-Off Characteristics vs. Collector Current

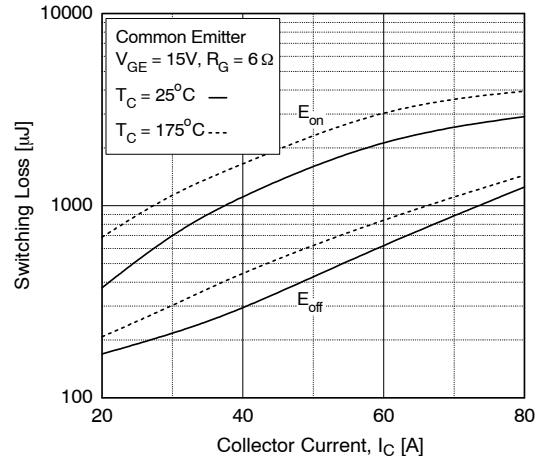

Figure 14. Switching Loss vs. Collector Current

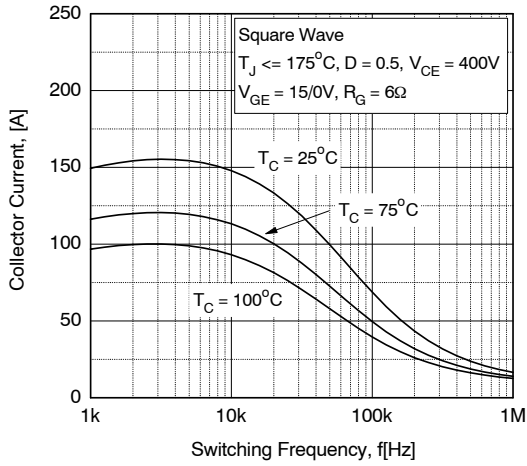

Figure 15. Load Current vs. Frequency

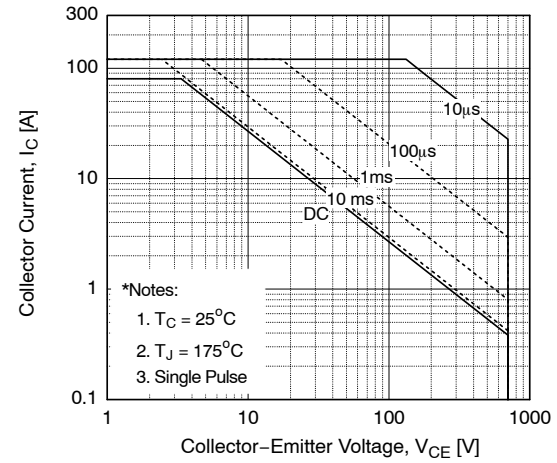

Figure 16. SOA Characteristics

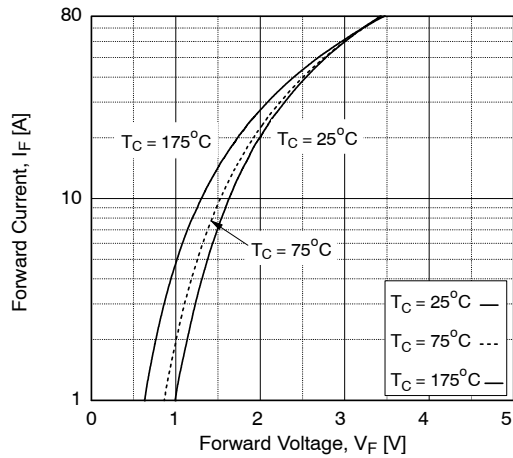

Figure 17. Forward Characteristics

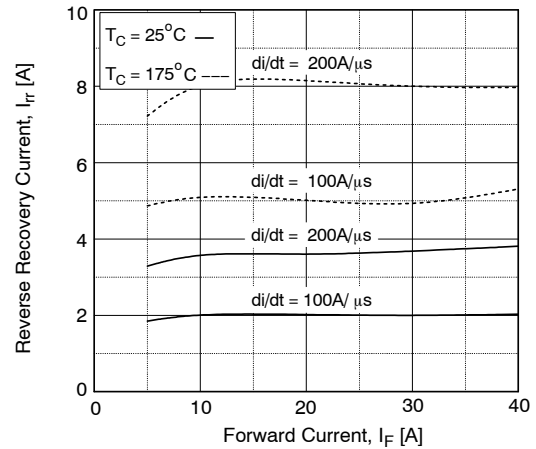

Figure 18. Reverse Recovery Current

FGH40T70SHD

TYPICAL PERFORMANCE CHARACTERISTICS

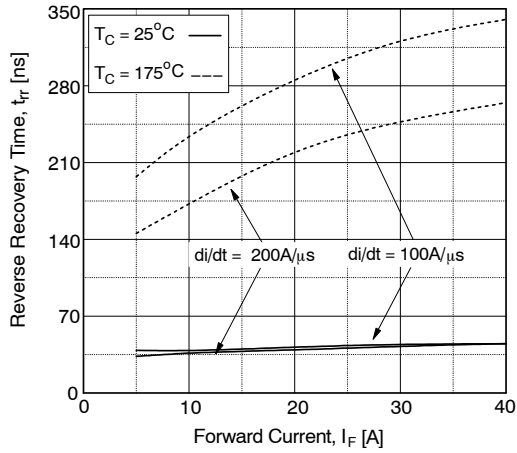

Figure 19. Reverse Recovery Time

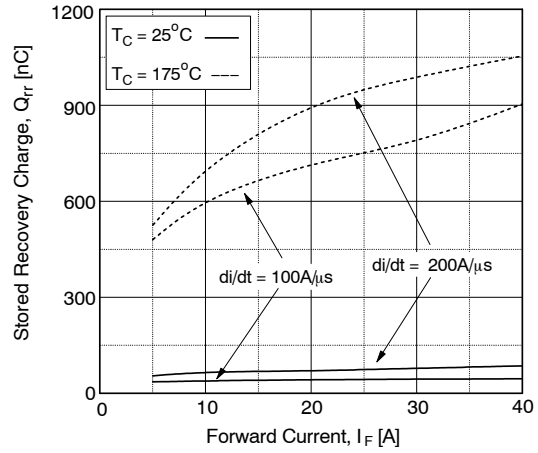

Figure 20. Stored Charge

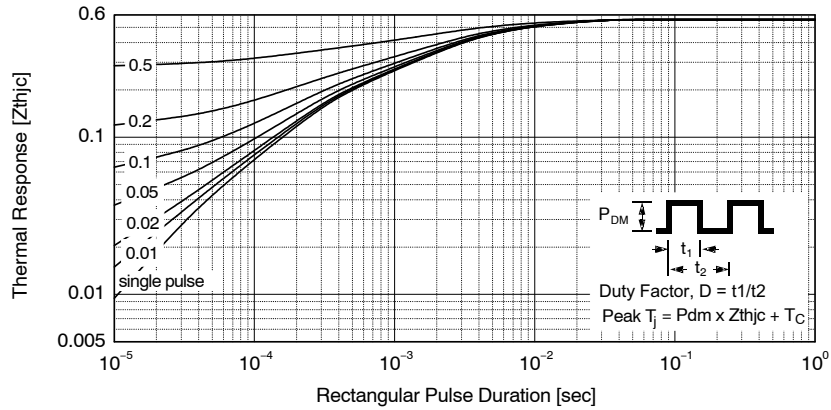

Figure 21. Transient Thermal Impedance of IGBT

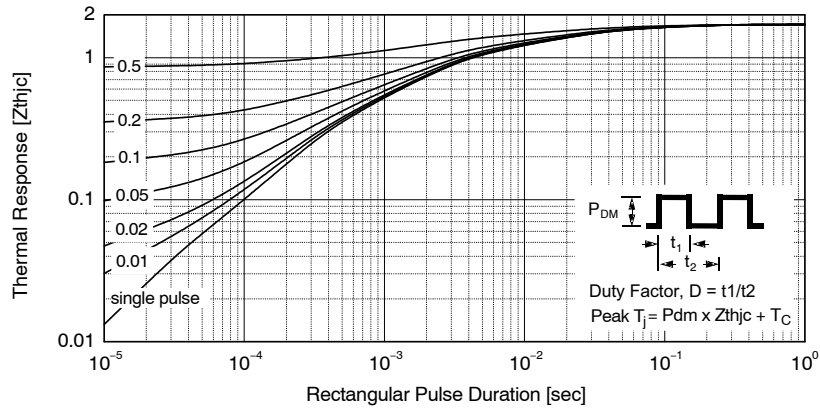

Figure 22. Transient Thermal Impedance of Diode

MECHANICAL CASE OUTLINE

PACKAGE DIMENSIONS

ON Semiconductor®



TO-247-3LD
CASE 340CH
ISSUE A

DATE 09 OCT 2019



NOTES: UNLESS OTHERWISE SPECIFIED.

- A. DIMENSIONS ARE EXCLUSIVE OF BURRS, MOLD FLASH, AND TIE BAR EXTRUSIONS.
- B. ALL DIMENSIONS ARE IN MILLIMETERS.
- C. DRAWING CONFORMS TO ASME Y14.5 - 2009.
- D. DIMENSION A1 TO BE MEASURED IN THE REGION DEFINED BY L1.
- E. LEAD FINISH IS UNCONTROLLED IN THE REGION DEFINED BY L1.

GENERIC MARKING DIAGRAM*



XXXX = Specific Device Code
A = Assembly Location
Y = Year
WW = Work Week
G = Pb-Free Package

*This information is generic. Please refer to device data sheet for actual part marking. Pb-Free indicator, "G" or microdot "•", may or may not be present. Some products may not follow the Generic Marking.

DIM	MILLIMETERS		
	MIN	NOM	MAX
A	4.58	4.70	4.82
A1	2.29	2.475	2.66
A2	1.40	1.50	1.60
D	20.32	20.57	20.82
E	15.37	15.62	15.87
E2	4.96	5.08	5.20
e	~	5.56	~
L	19.75	20.00	20.25
L1	3.69	3.81	3.93
∅P	3.51	3.58	3.65
Q	5.34	5.46	5.58
S	5.34	5.46	5.58
b	1.17	1.26	1.35
b2	1.53	1.65	1.77
b4	2.42	2.54	2.66
c	0.51	0.61	0.71
D1	13.08	~	~
D2	0.51	0.93	1.35
E1	12.81	~	~
∅P1	6.61	6.73	6.85

DOCUMENT NUMBER:	98AON13853G	Electronic versions are uncontrolled except when accessed directly from the Document Repository. Printed versions are uncontrolled except when stamped "CONTROLLED COPY" in red.
DESCRIPTION:	TO-247-3LD	PAGE 1 OF 1

ON Semiconductor and are trademarks of Semiconductor Components Industries, LLC dba ON Semiconductor or its subsidiaries in the United States and/or other countries. ON Semiconductor reserves the right to make changes without further notice to any products herein. ON Semiconductor makes no warranty, representation or guarantee regarding the suitability of its products for any particular purpose, nor does ON Semiconductor assume any liability arising out of the application or use of any product or circuit, and specifically disclaims any and all liability, including without limitation special, consequential or incidental damages. ON Semiconductor does not convey any license under its patent rights nor the rights of others.

ON Semiconductor and  are trademarks of Semiconductor Components Industries, LLC dba ON Semiconductor or its subsidiaries in the United States and/or other countries. ON Semiconductor owns the rights to a number of patents, trademarks, copyrights, trade secrets, and other intellectual property. A listing of ON Semiconductor's product/patent coverage may be accessed at www.onsemi.com/site/pdf/Patent-Marking.pdf. ON Semiconductor reserves the right to make changes without further notice to any products herein. ON Semiconductor makes no warranty, representation or guarantee regarding the suitability of its products for any particular purpose, nor does ON Semiconductor assume any liability arising out of the application or use of any product or circuit, and specifically disclaims any and all liability, including without limitation special, consequential or incidental damages. Buyer is responsible for its products and applications using ON Semiconductor products, including compliance with all laws, regulations and safety requirements or standards, regardless of any support or applications information provided by ON Semiconductor. "Typical" parameters which may be provided in ON Semiconductor data sheets and/or specifications can and do vary in different applications and actual performance may vary over time. All operating parameters, including "Typicals" must be validated for each customer application by customer's technical experts. ON Semiconductor does not convey any license under its patent rights nor the rights of others. ON Semiconductor products are not designed, intended, or authorized for use as a critical component in life support systems or any FDA Class 3 medical devices or medical devices with a same or similar classification in a foreign jurisdiction or any devices intended for implantation in the human body. Should Buyer purchase or use ON Semiconductor products for any such unintended or unauthorized application, Buyer shall indemnify and hold ON Semiconductor and its officers, employees, subsidiaries, affiliates, and distributors harmless against all claims, costs, damages, and expenses, and reasonable attorney fees arising out of, directly or indirectly, any claim of personal injury or death associated with such unintended or unauthorized use, even if such claim alleges that ON Semiconductor was negligent regarding the design or manufacture of the part. ON Semiconductor is an Equal Opportunity/Affirmative Action Employer. This literature is subject to all applicable copyright laws and is not for resale in any manner.

PUBLICATION ORDERING INFORMATION

LITERATURE FULFILLMENT:

Email Requests to: orderlit@onsemi.com

ON Semiconductor Website: www.onsemi.com

TECHNICAL SUPPORT

North American Technical Support:
Voice Mail: 1 800-282-9855 Toll Free USA/Canada
Phone: 011 421 33 790 2910

Europe, Middle East and Africa Technical Support:

Phone: 00421 33 790 2910

For additional information, please contact your local Sales Representative