

TPS55010EVM-051, Low-Power, Isolated, Fly-buck™ Dual-Output Converter

This user's guide contains information for the TPS55010EVM-051 evaluation module (PWR051). Included are the performance specifications, the schematic, and the bill of materials for the TPS55010EVM-051.

Contents

1	Introduction	3
	1.1 Background	3
	1.2 Performance Specification Summary	3
	1.3 Modifications	4
2	Test Setup and Results	4
	2.1 Input/Output Connections	4
	2.2 Efficiency	5
	2.3 Load Regulation	5
	2.4 Line Regulation	6
	2.5 Loop Characteristics	6
	2.6 Output Voltage Ripple	7
	2.7 Input Voltage Ripple	7
	2.8 Powering Up	8
3	Board Layout	9
	3.1 Layout	9
	3.2 Estimated Circuit Area	10
4	Schematic and Bill of Materials	11
	4.1 Schematic	11
	4.2 Bill of Materials	12

List of Figures

1	TPS55010EVM-051 Efficiency	5
2	TPS55010EVM-051 Load Regulation	5
3	TPS55010EVM-051 Line Regulation, $V_{IN} = 5\text{ V}$	6
4	TPS55010EVM-051 Loop Response	6
5	TPS55010EVM-051 Output Voltage Ripple	7
6	TPS55010EVM-051 Input Voltage Ripple	7
7	TPS55010EVM-051 Start-Up With Rising V_{IN}	8
8	TPS55010EVM-051 Top Assembly.....	9
9	TPS55010EVM-051 Top Copper	9
10	TPS55010EVM-051 Bottom Copper.....	10
11	TPS55010EVM-051 Bottom Assembly	10
12	TPS55010EVM-051 Schematic.....	11

List of Tables

1	Input Voltage and Output Current Summary	3
2	TPS55010EVM-051 Electrical and Performance Specification	3

Fly-buck, PowerPAD are trademarks of Texas Instruments.

3	EVM Connectors and Test Points	4
4	Bill of Materials	12

1 Introduction

This user's guide contains background information for the TPS55010 as well as support documentation for the TPS55010EVM-051 evaluation module (PWR051). Included are the performance specifications, the schematic, and the bill of materials for the TPS55010EVM-051.

1.1 Background

The TPS55010EVM-051 is designed to provide dual 40-mA outputs from an input voltage source of 4.5 V to 5.5 V. Rated input voltage and output current range for the evaluation module are given in [Table 1](#). This evaluation module is designed to demonstrate the small, printed-circuit-board areas that may be achieved when designing with the TPS55010 regulator. The switching frequency is externally set at a nominal 400 kHz. Both high-side and low-side MOSFETs are incorporated inside the TPS55010 package along with the gate drive circuitry. The low drain-to-source on-resistance of the MOSFETs allows the TPS55010 to achieve good efficiency. The compensation components are external to the integrated circuit (IC), and an external divider allows for an adjustable output voltage. Additionally, the TPS55010 provides adjustable slow-start and undervoltage lockout inputs. The absolute maximum input voltage for the TPS55010EVM-051 is 7 V.

Table 1. Input Voltage and Output Current Summary

EVM	INPUT VOLTAGE RANGE	OUTPUT CURRENT RANGE
TPS55010EVM-051	$V_{IN} = 3 \text{ V to } 6 \text{ V}$	0 A to 40 mA (dual outputs)

1.2 Performance Specification Summary

A summary of the TPS55010EVM-051 performance specifications is provided in [Table 2](#). Specifications are given for an input voltage of $V_{IN} = 5 \text{ V}$ and an output voltage of 5 V, unless otherwise specified. The TPS55010EVM-051 is designed and tested for $V_{IN} = 4 \text{ V to } 6 \text{ V}$. The ambient temperature is 25°C for all measurements, unless otherwise noted.

Table 2. TPS55010EVM-051 Electrical and Performance Specification

Parameter	Condition				UNIT		
		MIN	TYP	MAX			
Output voltage	$4.5 \text{ V} \leq V_{IN} \leq 5.5 \text{ V}$, $I_{LOAD} = \pm 40 \text{ mA}$	5 V	± 14	± 15	± 21	V	
Output current	$4.5 \text{ V} \leq V_{IN} \leq 5.5 \text{ V}$				± 0.04	A	
Output ripple voltage, peak-to-peak	$I_{LOAD} = \pm 40 \text{ mA}$	$V_{IN} = 5 \text{ V}$			15	mV	
Switching frequency	$I_{LOAD} = \pm 40 \text{ mA}$	$V_{IN} = 5 \text{ V}$			400	kHz	
Efficiency, end-to-end	$I_{LOAD} = \pm 40 \text{ mA}$	$V_{IN} = 5 \text{ V}$			90	%	
Line regulation	$I_{LOAD} = \pm 20 \text{ mA}$, $4.5 \text{ V} \leq V_{IN} \leq 5.5 \text{ V}$	$V_{IN} = 5 \text{ V}$			± 0.25	V	
Load regulation	$I_{LOAD} = 5 \text{ mA to } 40 \text{ mA}$	$V_{IN} = 5 \text{ V}$			± 2	V	
Control loop crossover frequency	$I_{LOAD} = \pm 40 \text{ mA}$				0.6	kHz	
Slow start					40	ms	
Operating temperature					-25	85	°C

1.3 Modifications

These evaluation modules are designed to provide access to the features of the TPS55010. Some modifications can be made to this module.

1.3.1 Zener Diode and Output Snubber

Under no-load conditions, VOUT can get as high as ± 30 V if output voltage limiting is not provided. TPS55010EVM-051 provides two Zener diodes (18 V nominal) in series with a resistor to limit the output voltages at J2 to ± 20 V. The Zener diodes present negligible load to the circuit with external loads above approximately 1 mA.

2 Test Setup and Results

This section describes how to properly connect, set up, and use the TPS55010EVM-051 evaluation module. The section also includes test results typical for the evaluation module and covers efficiency, output voltage regulation, load transients, loop response, output ripple, input ripple, and start-up.

2.1 Input/Output Connections

The TPS55010EVM-051 is provided with input/output connectors and test points as shown in [Table 3](#). A power supply capable of supplying 0.5 A must be connected to J1 through a pair of 20 AWG wires. Test-point TP2 provides a place to monitor the V_{IN} input voltages with TP5 providing a convenient ground reference. TP10 and TP13 are used to monitor and load the output voltages with TP4 and TP14 as the ground references.

Table 3. EVM Connectors and Test Points

Reference Designator	Label	Description
J1	INPUT	VIN connector
TP10	+VOUT	Positive VOUT circuit point
TP2	VIN	Input VIN circuit point
TP5	GND	Input GND circuit point
TP13	-VOUT	Negative VOUT circuit point
TP4, TP14	AGND	Output AGND circuit point
TP1	FLT	FAULT pin
TP3	EN	EN pin
TP6	SS	SLOW START pin
TP7	PH	PH pin
TP8	LOOP	Injection point for loop measurements
TP9	VC	Regulated voltage
TP11	RTC	RTCLK pin
TP12	GND	Input GND circuit point

2.2 Efficiency

Figure 1 shows the efficiency for the TPS55010EVM-051 at an ambient temperature of 25°C.

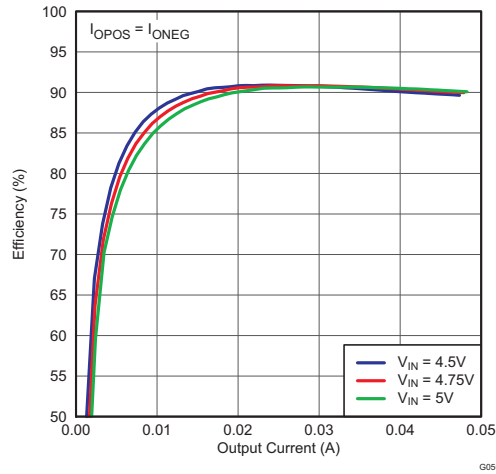

Figure 1. TPS55010EVM-051 Efficiency

The efficiency may be lower at higher ambient temperatures, due to temperature variation in the drain-to-source resistance of the internal MOSFET.

2.3 Load Regulation

Figure 2 shows the load regulation for the TPS55010EVM-051 at an ambient temperature of 25°C.

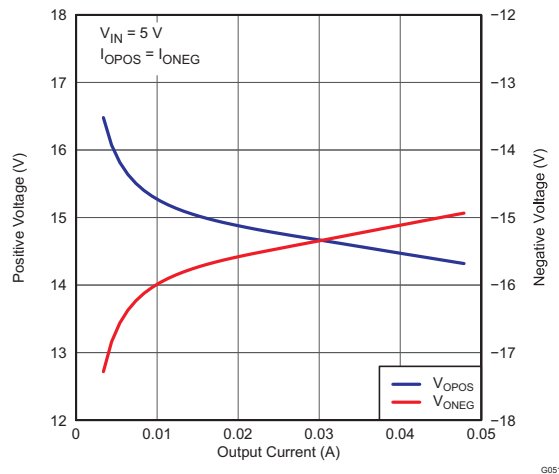

Figure 2. TPS55010EVM-051 Load Regulation

2.4 Line Regulation

Figure 3 shows the line regulation for the TPS55010EVM-051 at an ambient temperature of 25°C.

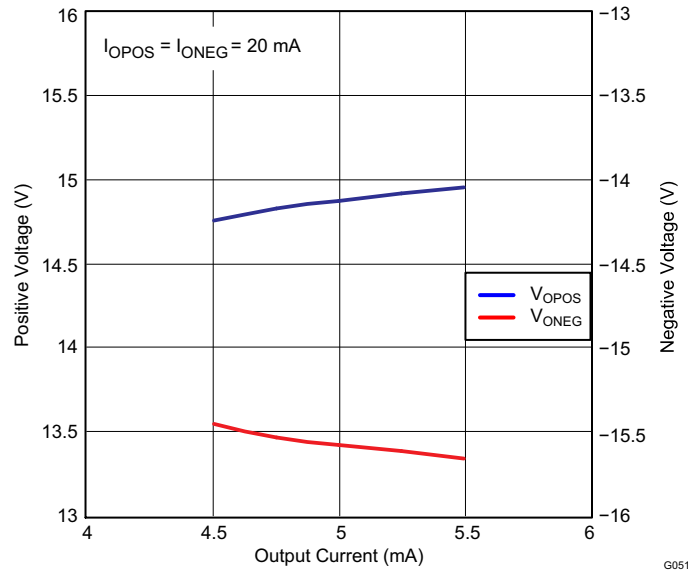

Figure 3. TPS55010EVM-051 Line Regulation, V_{IN} = 5 V

2.5 Loop Characteristics

The TPS55010EVM-051 loop-response characteristics are shown in Figure 4. Gain and phase plots are shown for V_{IN} = 5 V and load current = ± 40 mA. The unity gain bandwidth is 600 Hz and phase margin is 45 degrees.

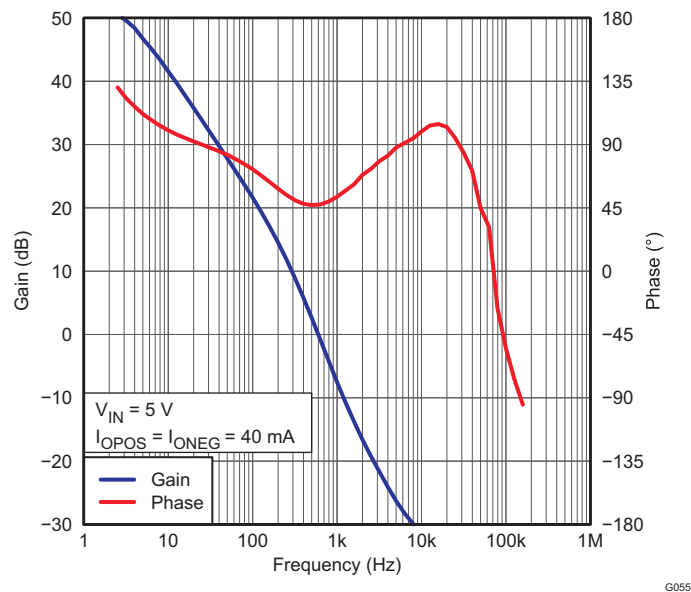

Figure 4. TPS55010EVM-051 Loop Response

2.6 Output Voltage Ripple

The TPS55010EVM-051 output voltage ripple is shown in Figure 5. The output current is the rated full load of ± 40 mA and $V_{IN} = 5$ V. The ripple voltage is measured directly across the positive output capacitor.

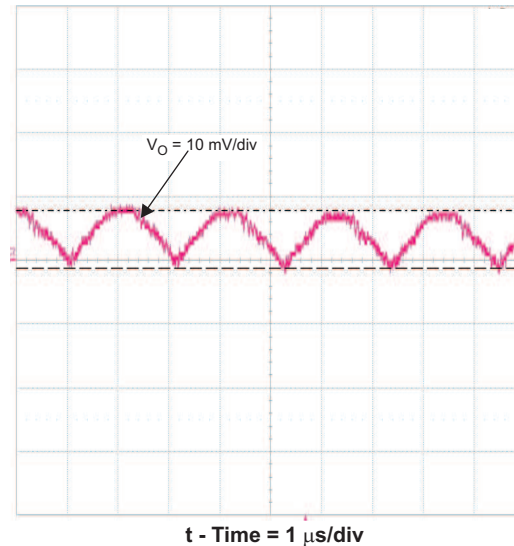

Figure 5. TPS55010EVM-051 Output Voltage Ripple

2.7 Input Voltage Ripple

The TPS55010EVM-051 input voltage ripple is shown in Figure 6. The output current is the rated full load of ± 40 mA and $V_{IN} = 5$ V. The ripple voltage is measured directly across the input capacitors.

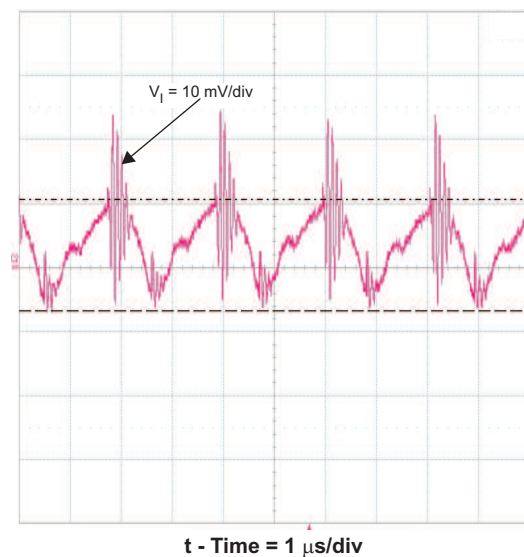

Figure 6. TPS55010EVM-051 Input Voltage Ripple

2.8 Powering Up

Figure 7 shows the start-up waveforms with rising V_{IN} and the output loaded with $360\ \Omega$. In Figure 7, the output starts to rise when V_{IN} reaches the rising UVLO of $4.5\ V$.

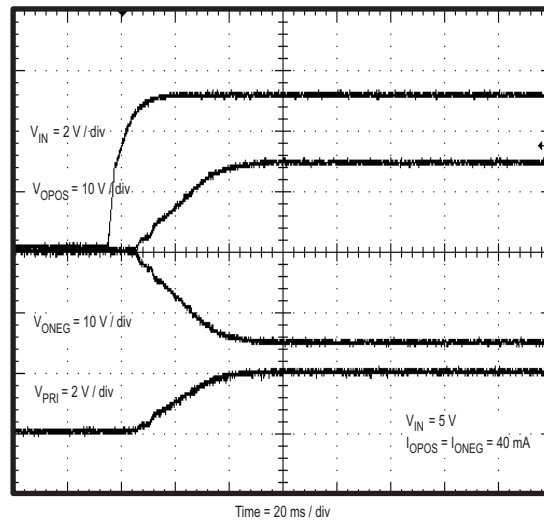

Figure 7. TPS55010EVM-051 Start-Up With Rising V_{IN}

3 Board Layout

This section provides a description of the TPS55010EVM-051, board layout, and layer illustrations.

3.1 Layout

The board layout for the TPS55010EVM-051 is shown in [Figure 8](#) through [Figure 11](#). The top-side layer of the EVM is laid out in a manner typical of a user application. The top and bottom layers are 2-oz copper. A basic set of layout guidelines include:

- Place the input capacitors close to the TPS55010 VIN and GND terminals.
- Arrange the transformer, input capacitors, and the regulated voltage capacitor in a manner to minimize loop area.
- Connect the GND end of the analog control circuitry (COMP, VSENSE, RT/CLK, and SS pins) together apart from the main power GND. Reference this analog GND trace/shape to the power GND (PowerPAD™ IC package of TPS55010) at a single point.
- The PowerPAD™ package of the TPS55010 provides a means to remove heat from the device and must be connected to the GND plane with multiple vias as shown in the TPS55010 data sheet, [SLVSAV0](#).

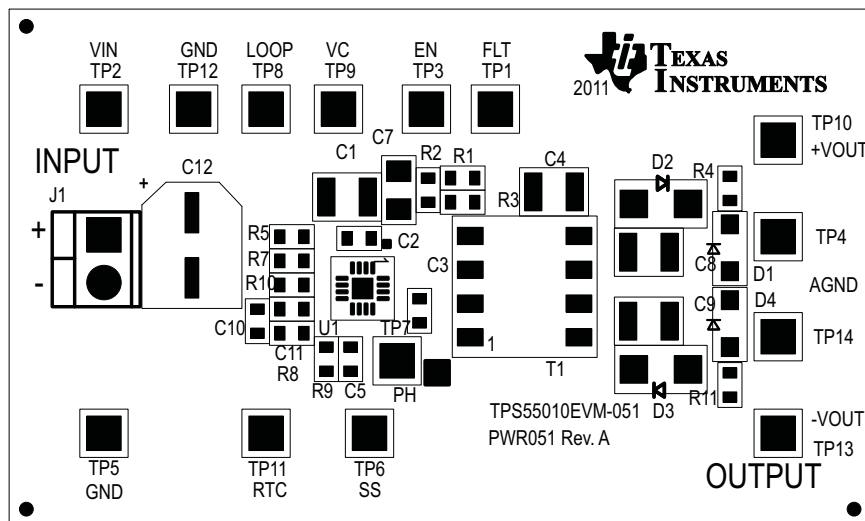

Figure 8. TPS55010EVM-051 Top Assembly

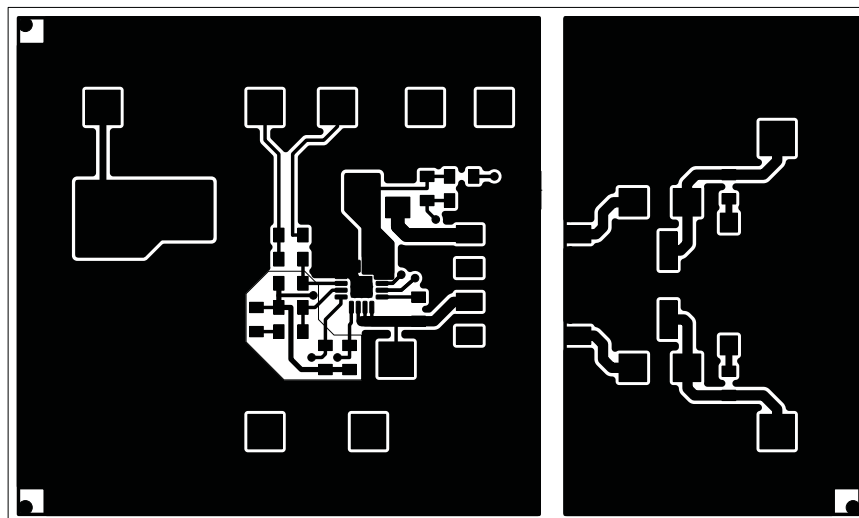

Figure 9. TPS55010EVM-051 Top Copper

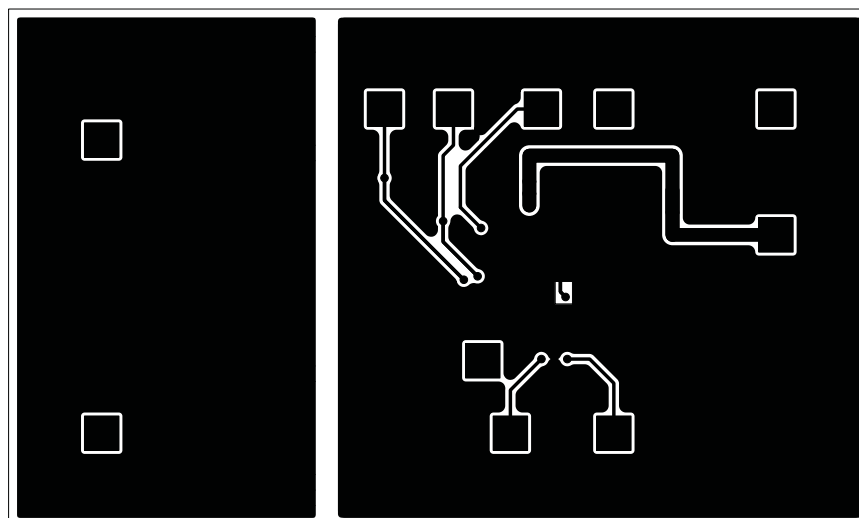

Figure 10. TPS55010EVM-051 Bottom Copper

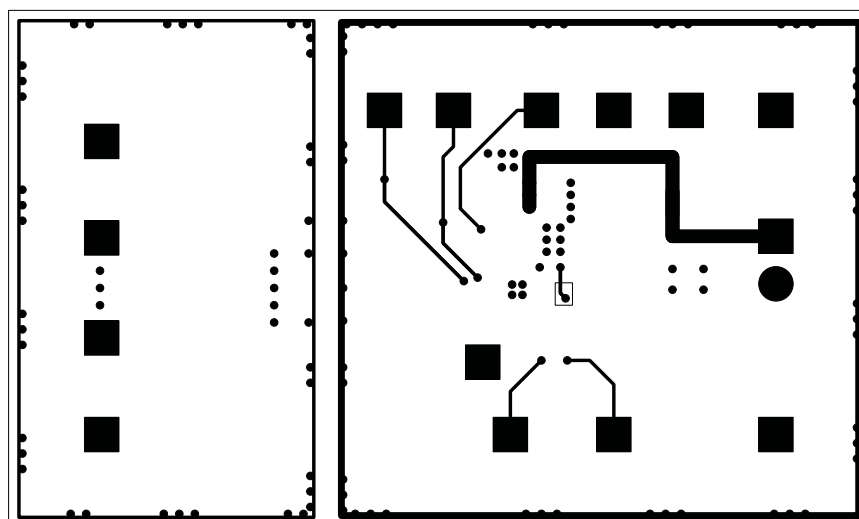

Figure 11. TPS55010EVM-051 Bottom Assembly

3.2 Estimated Circuit Area

The estimated printed-circuit board area for the components used in this design is 0.70 in². This area does not include test points or connectors.

4 Schematic and Bill of Materials

This section presents the TPS55010EVM-051 schematic and bill of materials.

4.1 Schematic

Figure 12 is the schematic for the TPS55010EVM-051.

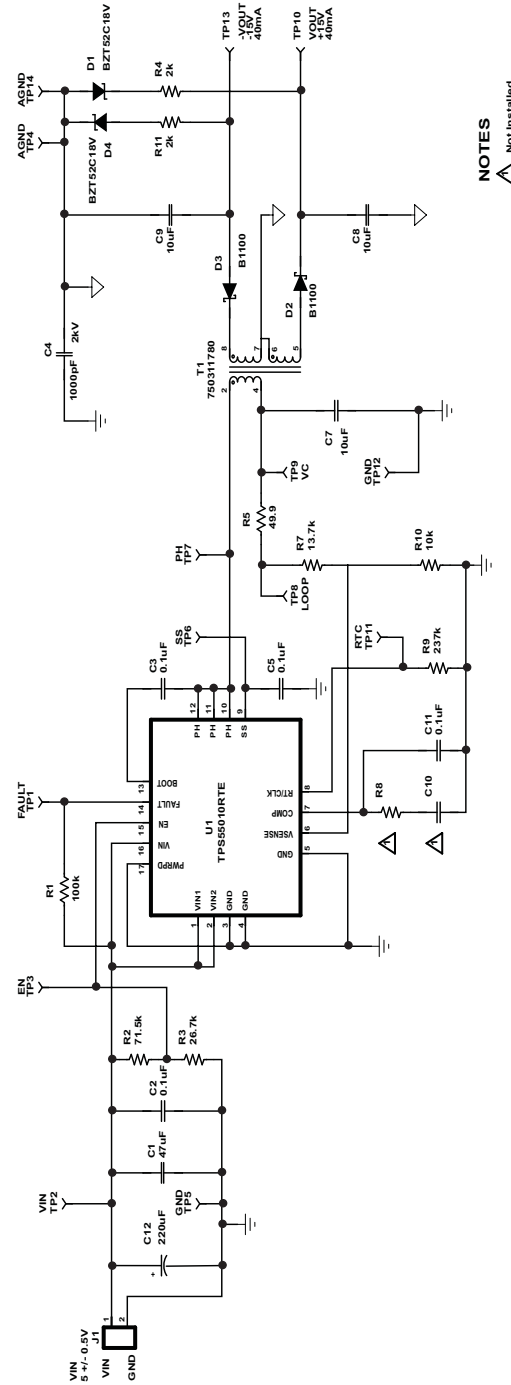

Figure 12. TPS55010EVM-051 Schematic

4.2 Bill of Materials

Table 4 presents the bill of materials for the TPS55010EVM-051.

Table 4. Bill of Materials

Count	RefDes	Value	Description	Size	Part Number	MFR
1	C1	47 μ F	Capacitor, Ceramic, 10V, X5R, 10%	1210	Std	Std
4	C2, C3, C5, C11	0.1 μ F	Capacitor, Ceramic, 16V, X7R, 10%	0603	Std	Std
1	C4	1000pF	Capacitor, Ceramic, 2kV, X7R, 10%	1210	Std	Std
1	C7	10 μ F	Capacitor, Ceramic, 10V, X5R, 10%	1206	Std	Std
2	C8, C9	10 μ F	Capacitor, Ceramic, 25V, X5R, 10%	1210	Std	Std
0	C10	DNP	Capacitor, Ceramic, 16V, X7R, 10%	0603	Std	Std
1	C12	220 μ F	Capacitor, Aluminum, 6.3V, \pm 20%	0.260 x 0.276 inch	EEE-FK0J221P	Panasonic
2	D1, D4	BZT52C18V	Diode, Zener, Planar Power, 500mW, 18V	SOD-123	BZT52C18-7-F	Diodes, Inc
2	D2, D3	B1100	Diode, Schottky, 1000-mA, 100-V	SMA	B1100-13-F	Diodes, Inc
1	J1	ED555/2DS	Terminal Block, 2-pin, 6-A, 3.5mm	0.27 x 0.25 inch	ED555/2DS	OST
1	R1	100k	Resistor, Chip, 1/16W, 1%	0603	Std	Std
1	R2	71.5k	Resistor, Chip, 1/16W, 1%	0603	Std	Std
1	R3	26.7k	Resistor, Chip, 1/16W, 1%	0603	Std	Std
2	R4, R11	2k	Resistor, Chip, 1/16W, 1%	0603	Std	Std
1	R5	49.9	Resistor, Chip, 1/16W, 1%	0603	Std	Std
1	R7	13.7k	Resistor, Chip, 1/16W, 1%	0603	Std	Std
0	R8	DNP	Resistor, Chip, 1/16W, 1%	0603	Std	Std
1	R9	237k	Resistor, Chip, 1/16W, 1	0603	Std	Std
1	R10	61.9k	Resistor, Chip, 1/16W, 1	0603	Std	Std
4	TP1, TP3, TP6, TP11	5012	Test Point, White, Thru Hole	0.125 x 0.125 inch	5012	Keystone
4	TP2, TP9, TP10, TP13	5010	Test Point, Red, Thru Hole	0.125 x 0.125 inch	5010	Keystone
4	TP4, TP5, TP12, TP14	5011	Test Point, Black, Thru Hole	0.125 x 0.125 inch	5011	Keystone
2	TP7, TP8	5013	Test Point, Orange, Thru Hole	0.125 x 0.125 inch	5013	Keystone
1	T1	2 μ H	Transformer, \pm 10%	0.410 x 0.510 inch	750311780	Wurth
1	U1	TPS55010RTE	IC, DC-DC Converter	QFN-16	TPS55010RTE	TI
1	--		PCB, 2.5 In x 1.5 In x 0.062 In	2.5" x 2.5" x 0.062"	PWR051	Any

Evaluation Board/Kit Important Notice

Texas Instruments (TI) provides the enclosed product(s) under the following conditions:

This evaluation board/kit is intended for use for **ENGINEERING DEVELOPMENT, DEMONSTRATION, OR EVALUATION PURPOSES ONLY** and is not considered by TI to be a finished end-product fit for general consumer use. Persons handling the product(s) must have electronics training and observe good engineering practice standards. As such, the goods being provided are not intended to be complete in terms of required design-, marketing-, and/or manufacturing-related protective considerations, including product safety and environmental measures typically found in end products that incorporate such semiconductor components or circuit boards. This evaluation board/kit does not fall within the scope of the European Union directives regarding electromagnetic compatibility, restricted substances (RoHS), recycling (WEEE), FCC, CE or UL, and therefore may not meet the technical requirements of these directives or other related directives.

Should this evaluation board/kit not meet the specifications indicated in the User's Guide, the board/kit may be returned within 30 days from the date of delivery for a full refund. **THE FOREGOING WARRANTY IS THE EXCLUSIVE WARRANTY MADE BY SELLER TO BUYER AND IS IN LIEU OF ALL OTHER WARRANTIES, EXPRESSED, IMPLIED, OR STATUTORY, INCLUDING ANY WARRANTY OF MERCHANTABILITY OR FITNESS FOR ANY PARTICULAR PURPOSE.**

The user assumes all responsibility and liability for proper and safe handling of the goods. Further, the user indemnifies TI from all claims arising from the handling or use of the goods. Due to the open construction of the product, it is the user's responsibility to take any and all appropriate precautions with regard to electrostatic discharge.

EXCEPT TO THE EXTENT OF THE INDEMNITY SET FORTH ABOVE, NEITHER PARTY SHALL BE LIABLE TO THE OTHER FOR ANY INDIRECT, SPECIAL, INCIDENTAL, OR CONSEQUENTIAL DAMAGES.

TI currently deals with a variety of customers for products, and therefore our arrangement with the user **is not exclusive.**

TI assumes **no liability for applications assistance, customer product design, software performance, or infringement of patents or services described herein.**

Please read the User's Guide and, specifically, the Warnings and Restrictions notice in the User's Guide prior to handling the product. This notice contains important safety information about temperatures and voltages. For additional information on TI's environmental and/or safety programs, please contact the TI application engineer or visit www.ti.com/esh.

No license is granted under any patent right or other intellectual property right of TI covering or relating to any machine, process, or combination in which such TI products or services might be or are used.

FCC Warning

This evaluation board/kit is intended for use for **ENGINEERING DEVELOPMENT, DEMONSTRATION, OR EVALUATION PURPOSES ONLY** and is not considered by TI to be a finished end-product fit for general consumer use. It generates, uses, and can radiate radio frequency energy and has not been tested for compliance with the limits of computing devices pursuant to part 15 of FCC rules, which are designed to provide reasonable protection against radio frequency interference. Operation of this equipment in other environments may cause interference with radio communications, in which case the user at his own expense will be required to take whatever measures may be required to correct this interference.

EVM Warnings and Restrictions

It is important to operate this EVM within the input voltage range of 4 V to 6 V and the output voltage range of -22 V to +22 V .

Exceeding the specified input range may cause unexpected operation and/or irreversible damage to the EVM. If there are questions concerning the input range, please contact a TI field representative prior to connecting the input power.

Applying loads outside of the specified output range may result in unintended operation and/or possible permanent damage to the EVM. Please consult the EVM User's Guide prior to connecting any load to the EVM output. If there is uncertainty as to the load specification, please contact a TI field representative.

During normal operation, some circuit components may have case temperatures greater than 60°C. The EVM is designed to operate properly with certain components above 55°C as long as the input and output ranges are maintained. These components include but are not limited to linear regulators, switching transistors, pass transistors, and current sense resistors. These types of devices can be identified using the EVM schematic located in the EVM User's Guide. When placing measurement probes near these devices during operation, please be aware that these devices may be very warm to the touch.

Mailing Address: Texas Instruments, Post Office Box 655303, Dallas, Texas 75265
Copyright © 2012, Texas Instruments Incorporated

EVALUATION BOARD/KIT/MODULE (EVM) ADDITIONAL TERMS

Texas Instruments (TI) provides the enclosed Evaluation Board/Kit/Module (EVM) under the following conditions:

The user assumes all responsibility and liability for proper and safe handling of the goods. Further, the user indemnifies TI from all claims arising from the handling or use of the goods.

Should this evaluation board/kit not meet the specifications indicated in the User's Guide, the board/kit may be returned within 30 days from the date of delivery for a full refund. THE FOREGOING LIMITED WARRANTY IS THE EXCLUSIVE WARRANTY MADE BY SELLER TO BUYER AND IS IN LIEU OF ALL OTHER WARRANTIES, EXPRESSED, IMPLIED, OR STATUTORY, INCLUDING ANY WARRANTY OF MERCHANTABILITY OR FITNESS FOR ANY PARTICULAR PURPOSE. EXCEPT TO THE EXTENT OF THE INDEMNITY SET FORTH ABOVE, NEITHER PARTY SHALL BE LIABLE TO THE OTHER FOR ANY INDIRECT, SPECIAL, INCIDENTAL, OR CONSEQUENTIAL DAMAGES.

Please read the User's Guide and, specifically, the Warnings and Restrictions notice in the User's Guide prior to handling the product. This notice contains important safety information about temperatures and voltages. For additional information on TI's environmental and/or safety programs, please visit www.ti.com/esh or contact TI.

No license is granted under any patent right or other intellectual property right of TI covering or relating to any machine, process, or combination in which such TI products or services might be or are used. TI currently deals with a variety of customers for products, and therefore our arrangement with the user is not exclusive. TI assumes no liability for applications assistance, customer product design, software performance, or infringement of patents or services described herein.

REGULATORY COMPLIANCE INFORMATION

As noted in the EVM User's Guide and/or EVM itself, this EVM and/or accompanying hardware may or may not be subject to the Federal Communications Commission (FCC) and Industry Canada (IC) rules.

For EVMs **not** subject to the above rules, this evaluation board/kit/module is intended for use for ENGINEERING DEVELOPMENT, DEMONSTRATION OR EVALUATION PURPOSES ONLY and is not considered by TI to be a finished end product fit for general consumer use. It generates, uses, and can radiate radio frequency energy and has not been tested for compliance with the limits of computing devices pursuant to part 15 of FCC or ICES-003 rules, which are designed to provide reasonable protection against radio frequency interference. Operation of the equipment may cause interference with radio communications, in which case the user at his own expense will be required to take whatever measures may be required to correct this interference.

General Statement for EVMs including a radio

User Power/Frequency Use Obligations: This radio is intended for development/professional use only in legally allocated frequency and power limits. Any use of radio frequencies and/or power availability of this EVM and its development application(s) must comply with local laws governing radio spectrum allocation and power limits for this evaluation module. It is the user's sole responsibility to only operate this radio in legally acceptable frequency space and within legally mandated power limitations. Any exceptions to this are strictly prohibited and unauthorized by Texas Instruments unless user has obtained appropriate experimental/development licenses from local regulatory authorities, which is responsibility of user including its acceptable authorization.

For EVMs annotated as FCC – FEDERAL COMMUNICATIONS COMMISSION Part 15 Compliant

Caution

This device complies with part 15 of the FCC Rules. Operation is subject to the following two conditions: (1) This device may not cause harmful interference, and (2) this device must accept any interference received, including interference that may cause undesired operation.

Changes or modifications not expressly approved by the party responsible for compliance could void the user's authority to operate the equipment.

FCC Interference Statement for Class A EVM devices

This equipment has been tested and found to comply with the limits for a Class A digital device, pursuant to part 15 of the FCC Rules. These limits are designed to provide reasonable protection against harmful interference when the equipment is operated in a commercial environment. This equipment generates, uses, and can radiate radio frequency energy and, if not installed and used in accordance with the instruction manual, may cause harmful interference to radio communications. Operation of this equipment in a residential area is likely to cause harmful interference in which case the user will be required to correct the interference at his own expense.

FCC Interference Statement for Class B EVM devices

This equipment has been tested and found to comply with the limits for a Class B digital device, pursuant to part 15 of the FCC Rules. These limits are designed to provide reasonable protection against harmful interference in a residential installation. This equipment generates, uses and can radiate radio frequency energy and, if not installed and used in accordance with the instructions, may cause harmful interference to radio communications. However, there is no guarantee that interference will not occur in a particular installation. If this equipment does cause harmful interference to radio or television reception, which can be determined by turning the equipment off and on, the user is encouraged to try to correct the interference by one or more of the following measures:

- Reorient or relocate the receiving antenna.
- Increase the separation between the equipment and receiver.
- Connect the equipment into an outlet on a circuit different from that to which the receiver is connected.
- Consult the dealer or an experienced radio/TV technician for help.

For EVMs annotated as IC – INDUSTRY CANADA Compliant

This Class A or B digital apparatus complies with Canadian ICES-003.

Changes or modifications not expressly approved by the party responsible for compliance could void the user's authority to operate the equipment.

Concerning EVMs including radio transmitters

This device complies with Industry Canada licence-exempt RSS standard(s). Operation is subject to the following two conditions: (1) this device may not cause interference, and (2) this device must accept any interference, including interference that may cause undesired operation of the device.

Concerning EVMs including detachable antennas

Under Industry Canada regulations, this radio transmitter may only operate using an antenna of a type and maximum (or lesser) gain approved for the transmitter by Industry Canada. To reduce potential radio interference to other users, the antenna type and its gain should be so chosen that the equivalent isotropically radiated power (e.i.r.p.) is not more than that necessary for successful communication.

This radio transmitter has been approved by Industry Canada to operate with the antenna types listed in the user guide with the maximum permissible gain and required antenna impedance for each antenna type indicated. Antenna types not included in this list, having a gain greater than the maximum gain indicated for that type, are strictly prohibited for use with this device.

Cet appareil numérique de la classe A ou B est conforme à la norme NMB-003 du Canada.

Les changements ou les modifications pas expressément approuvés par la partie responsable de la conformité ont pu vider l'autorité de l'utilisateur pour actionner l'équipement.

Concernant les EVMs avec appareils radio

Le présent appareil est conforme aux CNR d'Industrie Canada applicables aux appareils radio exempts de licence. L'exploitation est autorisée aux deux conditions suivantes : (1) l'appareil ne doit pas produire de brouillage, et (2) l'utilisateur de l'appareil doit accepter tout brouillage radioélectrique subi, même si le brouillage est susceptible d'en compromettre le fonctionnement.

Concernant les EVMs avec antennes détachables

Conformément à la réglementation d'Industrie Canada, le présent émetteur radio peut fonctionner avec une antenne d'un type et d'un gain maximal (ou inférieur) approuvé pour l'émetteur par Industrie Canada. Dans le but de réduire les risques de brouillage radioélectrique à l'intention des autres utilisateurs, il faut choisir le type d'antenne et son gain de sorte que la puissance isotrope rayonnée équivalente (p.i.r.e.) ne dépasse pas l'intensité nécessaire à l'établissement d'une communication satisfaisante.

Le présent émetteur radio a été approuvé par Industrie Canada pour fonctionner avec les types d'antenne énumérés dans le manuel d'usage et ayant un gain admissible maximal et l'impédance requise pour chaque type d'antenne. Les types d'antenne non inclus dans cette liste, ou dont le gain est supérieur au gain maximal indiqué, sont strictement interdits pour l'exploitation de l'émetteur.

【Important Notice for Users of this Product in Japan】

This development kit is NOT certified as Confirming to Technical Regulations of Radio Law of Japan

If you use this product in Japan, you are required by Radio Law of Japan to follow the instructions below with respect to this product:

1. Use this product in a shielded room or any other test facility as defined in the notification #173 issued by Ministry of Internal Affairs and Communications on March 28, 2006, based on Sub-section 1.1 of Article 6 of the Ministry's Rule for Enforcement of Radio Law of Japan,
2. Use this product only after you obtained the license of Test Radio Station as provided in Radio Law of Japan with respect to this product, or
3. Use of this product only after you obtained the Technical Regulations Conformity Certification as provided in Radio Law of Japan with respect to this product. Also, please do not transfer this product, unless you give the same notice above to the transferee. Please note that if you could not follow the instructions above, you will be subject to penalties of Radio Law of Japan.

Texas Instruments Japan Limited
(address) 24-1, Nishi-Shinjuku 6 chome, Shinjuku-ku, Tokyo, Japan

<http://www.tij.co.jp>

【ご使用にあたっての注】

本開発キットは技術基準適合証明を受けておりません。

本製品のご使用に際しては、電波法遵守のため、以下のいずれかの措置を取っていただく必要がありますのでご注意ください。

1. 電波法施行規則第6条第1項第1号に基づく平成18年3月28日総務省告示第173号で定められた電波暗室等の試験設備でご使用いただく。
2. 実験局の免許を取得後ご使用いただく。
3. 技術基準適合証明を取得後ご使用いただく。

なお、本製品は、上記の「ご使用にあたっての注意」を譲渡先、移転先に通知しない限り、譲渡、移転できないものとします。

上記を遵守頂けない場合は、電波法の罰則が適用される可能性があることをご留意ください。

日本テキサス・インスツルメンツ株式会社
東京都新宿区西新宿6丁目24番1号
西新宿三井ビル

<http://www.tij.co.jp>

EVALUATION BOARD/KIT/MODULE (EVM) WARNINGS, RESTRICTIONS AND DISCLAIMERS

For Feasibility Evaluation Only, in Laboratory/Development Environments. Unless otherwise indicated, this EVM is not a finished electrical equipment and not intended for consumer use. It is intended solely for use for preliminary feasibility evaluation in laboratory/development environments by technically qualified electronics experts who are familiar with the dangers and application risks associated with handling electrical mechanical components, systems and subsystems. It should not be used as all or part of a finished end product.

Your Sole Responsibility and Risk. You acknowledge, represent and agree that:

1. You have unique knowledge concerning Federal, State and local regulatory requirements (including but not limited to Food and Drug Administration regulations, if applicable) which relate to your products and which relate to your use (and/or that of your employees, affiliates, contractors or designees) of the EVM for evaluation, testing and other purposes.
2. You have full and exclusive responsibility to assure the safety and compliance of your products with all such laws and other applicable regulatory requirements, and also to assure the safety of any activities to be conducted by you and/or your employees, affiliates, contractors or designees, using the EVM. Further, you are responsible to assure that any interfaces (electronic and/or mechanical) between the EVM and any human body are designed with suitable isolation and means to safely limit accessible leakage currents to minimize the risk of electrical shock hazard.
3. You will employ reasonable safeguards to ensure that your use of the EVM will not result in any property damage, injury or death, even if the EVM should fail to perform as described or expected.
4. You will take care of proper disposal and recycling of the EVM's electronic components and packing materials.

Certain Instructions. It is important to operate this EVM within TI's recommended specifications and environmental considerations per the user guidelines. Exceeding the specified EVM ratings (including but not limited to input and output voltage, current, power, and environmental ranges) may cause property damage, personal injury or death. If there are questions concerning these ratings please contact a TI field representative prior to connecting interface electronics including input power and intended loads. Any loads applied outside of the specified output range may result in unintended and/or inaccurate operation and/or possible permanent damage to the EVM and/or interface electronics. Please consult the EVM User's Guide prior to connecting any load to the EVM output. If there is uncertainty as to the load specification, please contact a TI field representative. During normal operation, some circuit components may have case temperatures greater than 60°C as long as the input and output are maintained at a normal ambient operating temperature. These components include but are not limited to linear regulators, switching transistors, pass transistors, and current sense resistors which can be identified using the EVM schematic located in the EVM User's Guide. When placing measurement probes near these devices during normal operation, please be aware that these devices may be very warm to the touch. As with all electronic evaluation tools, only qualified personnel knowledgeable in electronic measurement and diagnostics normally found in development environments should use these EVMs.

Agreement to Defend, Indemnify and Hold Harmless. You agree to defend, indemnify and hold TI, its licensors and their representatives harmless from and against any and all claims, damages, losses, expenses, costs and liabilities (collectively, "Claims") arising out of or in connection with any use of the EVM that is not in accordance with the terms of the agreement. This obligation shall apply whether Claims arise under law of tort or contract or any other legal theory, and even if the EVM fails to perform as described or expected.

Safety-Critical or Life-Critical Applications. If you intend to evaluate the components for possible use in safety critical applications (such as life support) where a failure of the TI product would reasonably be expected to cause severe personal injury or death, such as devices which are classified as FDA Class III or similar classification, then you must specifically notify TI of such intent and enter into a separate Assurance and Indemnity Agreement.

Mailing Address: Texas Instruments, Post Office Box 655303, Dallas, Texas 75265
Copyright © 2012, Texas Instruments Incorporated

IMPORTANT NOTICE

Texas Instruments Incorporated and its subsidiaries (TI) reserve the right to make corrections, enhancements, improvements and other changes to its semiconductor products and services per JESD46, latest issue, and to discontinue any product or service per JESD48, latest issue. Buyers should obtain the latest relevant information before placing orders and should verify that such information is current and complete. All semiconductor products (also referred to herein as "components") are sold subject to TI's terms and conditions of sale supplied at the time of order acknowledgment.

TI warrants performance of its components to the specifications applicable at the time of sale, in accordance with the warranty in TI's terms and conditions of sale of semiconductor products. Testing and other quality control techniques are used to the extent TI deems necessary to support this warranty. Except where mandated by applicable law, testing of all parameters of each component is not necessarily performed.

TI assumes no liability for applications assistance or the design of Buyers' products. Buyers are responsible for their products and applications using TI components. To minimize the risks associated with Buyers' products and applications, Buyers should provide adequate design and operating safeguards.

TI does not warrant or represent that any license, either express or implied, is granted under any patent right, copyright, mask work right, or other intellectual property right relating to any combination, machine, or process in which TI components or services are used. Information published by TI regarding third-party products or services does not constitute a license to use such products or services or a warranty or endorsement thereof. Use of such information may require a license from a third party under the patents or other intellectual property of the third party, or a license from TI under the patents or other intellectual property of TI.

Reproduction of significant portions of TI information in TI data books or data sheets is permissible only if reproduction is without alteration and is accompanied by all associated warranties, conditions, limitations, and notices. TI is not responsible or liable for such altered documentation. Information of third parties may be subject to additional restrictions.

Resale of TI components or services with statements different from or beyond the parameters stated by TI for that component or service voids all express and any implied warranties for the associated TI component or service and is an unfair and deceptive business practice. TI is not responsible or liable for any such statements.

Buyer acknowledges and agrees that it is solely responsible for compliance with all legal, regulatory and safety-related requirements concerning its products, and any use of TI components in its applications, notwithstanding any applications-related information or support that may be provided by TI. Buyer represents and agrees that it has all the necessary expertise to create and implement safeguards which anticipate dangerous consequences of failures, monitor failures and their consequences, lessen the likelihood of failures that might cause harm and take appropriate remedial actions. Buyer will fully indemnify TI and its representatives against any damages arising out of the use of any TI components in safety-critical applications.

In some cases, TI components may be promoted specifically to facilitate safety-related applications. With such components, TI's goal is to help enable customers to design and create their own end-product solutions that meet applicable functional safety standards and requirements. Nonetheless, such components are subject to these terms.

No TI components are authorized for use in FDA Class III (or similar life-critical medical equipment) unless authorized officers of the parties have executed a special agreement specifically governing such use.

Only those TI components which TI has specifically designated as military grade or "enhanced plastic" are designed and intended for use in military/aerospace applications or environments. Buyer acknowledges and agrees that any military or aerospace use of TI components which have **not** been so designated is solely at the Buyer's risk, and that Buyer is solely responsible for compliance with all legal and regulatory requirements in connection with such use.

TI has specifically designated certain components which meet ISO/TS16949 requirements, mainly for automotive use. Components which have not been so designated are neither designed nor intended for automotive use; and TI will not be responsible for any failure of such components to meet such requirements.

Products

Audio	www.ti.com/audio
Amplifiers	amplifier.ti.com
Data Converters	dataconverter.ti.com
DLP® Products	www.dlp.com
DSP	dsp.ti.com
Clocks and Timers	www.ti.com/clocks
Interface	interface.ti.com
Logic	logic.ti.com
Power Mgmt	power.ti.com
Microcontrollers	microcontroller.ti.com
RFID	www.ti-rfid.com
OMAP Applications Processors	www.ti.com/omap
Wireless Connectivity	www.ti.com/wirelessconnectivity

Applications

Automotive and Transportation	www.ti.com/automotive
Communications and Telecom	www.ti.com/communications
Computers and Peripherals	www.ti.com/computers
Consumer Electronics	www.ti.com/consumer-apps
Energy and Lighting	www.ti.com/energy
Industrial	www.ti.com/industrial
Medical	www.ti.com/medical
Security	www.ti.com/security
Space, Avionics and Defense	www.ti.com/space-avionics-defense
Video and Imaging	www.ti.com/video

TI E2E Community

e2e.ti.com