

Using the TPS53316EVM-075

User's Guide



Literature Number: SLUU671
December 2011

5-A Step-Down Regulator with Integrated Switcher

1 Introduction

The TPS53316EVM-075 evaluation module (EVM) is a step-down regulator featuring TPS53316. The TPS53316 is a fully integrated step-down regulator employing voltage mode control.

2 Description

The TPS53316EVM-075 is designed to use a 3.3-V or 5-V voltage rail to produce a regulated 1.5-V output at up to 5-A load current. The TPS53316EVM-075 is designed to demonstrate the TPS53316 in a typical low voltage application while providing a number of test points to evaluate the performance of the TPS53316.

2.1 Typical Applications

- Low-Voltage Applications for 5-V Step-Down Rails
- Low-Voltage Applications for 3.3-V Step-Down Rails

2.2 Features

The TPS53316EVM-075 features:

- Continuous 5-A Output Current Capability
- Supports all MLCC Output Capacitors
- Voltage Mode Control
- Selectable Light-Load Operation Modes (Forced Continuous Conduction Mode (FCCM), Diode-Emulation (DE) Mode and High-Efficiency (HEF) Mode)
- Selectable Switching Frequency Settings (750 kHz, 1.1 MHz, and 2.0 MHz)
- Selectable Overcurrent Threshold
- Soft-Stop Output Discharge During Disable
- Over Current, Over Voltage, Under voltage and Over Temperature Protections
- Power Good Indication
- Pre-Bias Output Voltage Start Up
- Convenient Test Points for Probing Critical Waveforms

3 Electrical Performance Specifications

Table 1. TPS53316EVM-075 Electrical Performance Specifications

PARAMETER	TEST CONDITIONS	MIN	TYP	MAX	UNITS
Input Characteristics					
Voltage range	V_{IN}	2.9	3.3/5.0	6.0	V
Maximum input current	$V_{IN} = 5\text{ V}$, $I_{OUT} = 5\text{ A}$		1.76		A
No load input current	$V_{IN} = 5\text{ V}$, $I_{OUT} = 0\text{ A}$ under DE/HEF mode		3		mA
Output Characteristics					
Output voltage			1.5		V
Output voltage regulation	Setpoint accuracy ($V_{IN} = 2.9\text{ V} - 6.0\text{ V}$, $I_{OUT} = 0\text{ A} - 5\text{ A}$)	-1%		1%	
	Line regulation ($V_{IN} = 2.9\text{ V} - 6.0\text{ V}$, $I_{OUT} = 5\text{ A}$)		0.1%		
	Load regulation ($V_{IN} = 5\text{ V}$, $I_{OUT} = 0\text{ A} - 5\text{ A}$)		0.1%		
Output voltage ripple	$V_{IN} = 5\text{ V}$, $I_{OUT} = 5\text{ A}$		10		mV _{PP}
Output load current		0		5	A
Over current limit	$V_{IN} = 3.3\text{ V}$, $f_{SW} = 750\text{ kHz}$		6.5/4.5		
Systems Characteristics					
Switching frequency			0.75/1.1/ 2.0		MHz
Peak efficiency	$V_{IN} = 5\text{ V}$, $I_{OUT} = 1.8\text{ A}$, $f_{SW} = 750\text{ kHz}$		92.7%		
Full-load efficiency	$V_{IN} = 5\text{ V}$, $I_{OUT} = 5\text{ A}$, $f_{SW} = 750\text{ kHz}$		89.0%		
Operating temperature			25		°C

4 Schematic

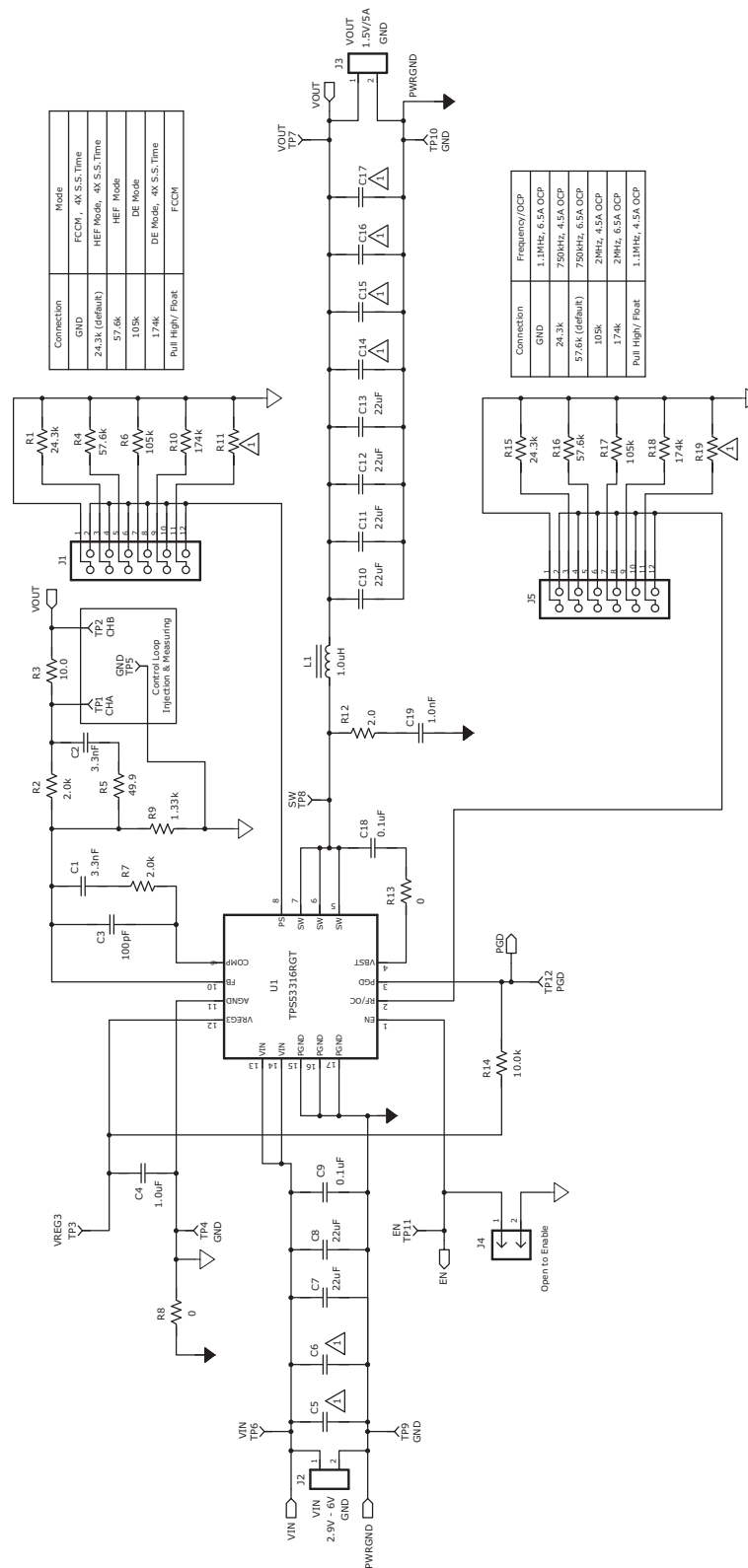

Notes:  NOT POPULATED

Figure 1. TPS53316EVM-075 Schematic

5 Test Setup

5.1 Test Equipment

Voltage Source, VIN: The input voltage source VIN should be a 0-V to 6-V variable DC source capable of supplying 5 A_{DC}. Connect VIN to J2 as shown in [Figure 3](#).

Multimeters:

- **V1:** VIN at TP6 (VIN) and TP9 (GND), 0-V to 6-V voltmeter
- **V2:** VOUT at TP7 (VOUT) and TP10 (GND)
- **A1:** VIN input current, 0-A_{DC} to 5-A_{DC} Ammeter

Output Load: The output load should be an electronic constant resistance mode load capable of 0 A_{DC} to 5 A_{DC} at 1.5 V.

Oscilloscope: A digital or analog oscilloscope can be used to measure the output ripple. The oscilloscope should be set for 1-MΩ impedance, 20-MHz bandwidth, AC coupling, 1-μs/division horizontal resolution for 750-kHz switching frequency, 20-mV/division vertical resolution. Test points TP7 and TP10 can be used to measure the output ripple voltage by placing the oscilloscope probe tip through TP7 and holding the ground barrel on TP10 as shown in [Figure 2](#). Using a leaded ground connection may induce additional noise due to the large ground loop.

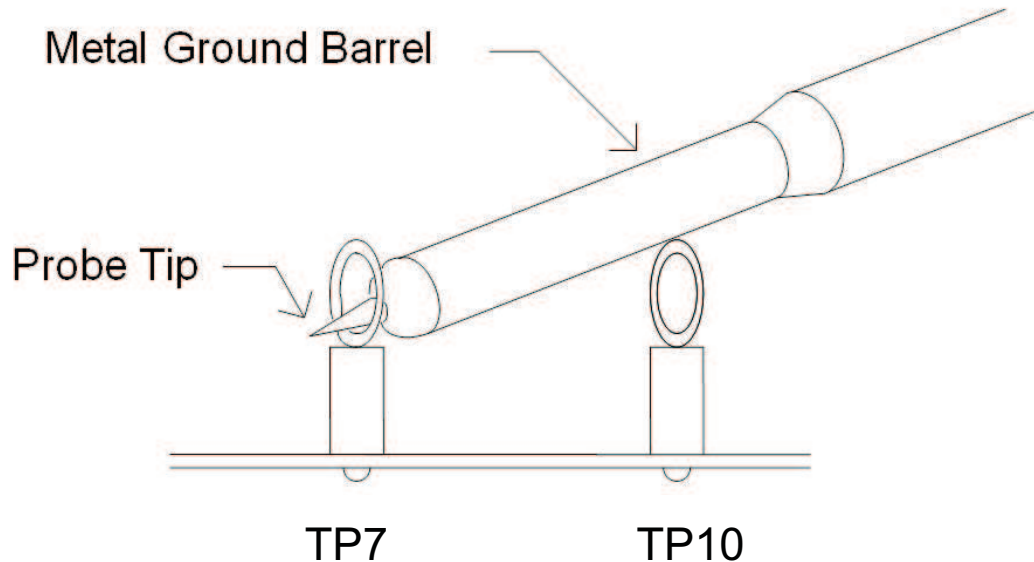

Figure 2. Tip and Barrel Measurement for VOUT Ripple

Fan: Some of the components in this EVM may approach temperatures of 55°C during operation. A small fan capable of 200 LFM to 400 LFM is recommended to reduce component temperatures while the EVM is operating. The EVM should not be probed while the fan is not running.

Recommended Wire Gauge:

- **VIN to J2:** The recommended wire size is 1x AWG #14 per input connection, with the total length of wire less than 4 feet (2 feet input, 2 feet return).
- **J3 to LOAD:** The minimum recommended wire size is 1x AWG #14, with the total length of wire less than 4 feet (2 feet output, 2 feet return)

5.2 Recommended Test Setup

Figure 3 is the recommended test set up to evaluate the TPS53316EVM-075. Working at an ESD workstation, make sure that any wrist straps, bootstraps or mats are connected referencing the user to earth ground before power is applied to the EVM.

Input Connections:

1. Prior to connecting the DC input source V_{IN} , it is advisable to limit the source current from V_{IN} to 5 A maximum. Make sure V_{IN} is initially set to 0 V and connected to J2 as shown in Figure 3.
2. Connect a current meter A1 between V_{IN} and J2 to measure the input current.
3. Connect a voltmeter V1 at TP6 (V_{IN}) and TP9 (GND) to measure the input voltage.

Output Connections:

1. Connect Load to J3 and set Load to constant resistance mode to sink 0 A_{DC} before V_{IN} is applied.
2. Connect a voltmeter V2 at TP7 (V_{OUT}) and TP10 (GND) to measure the output voltage.

Other Connections: Place a Fan as shown in Figure 3 and turn on, making sure air is flowing across the EVM.

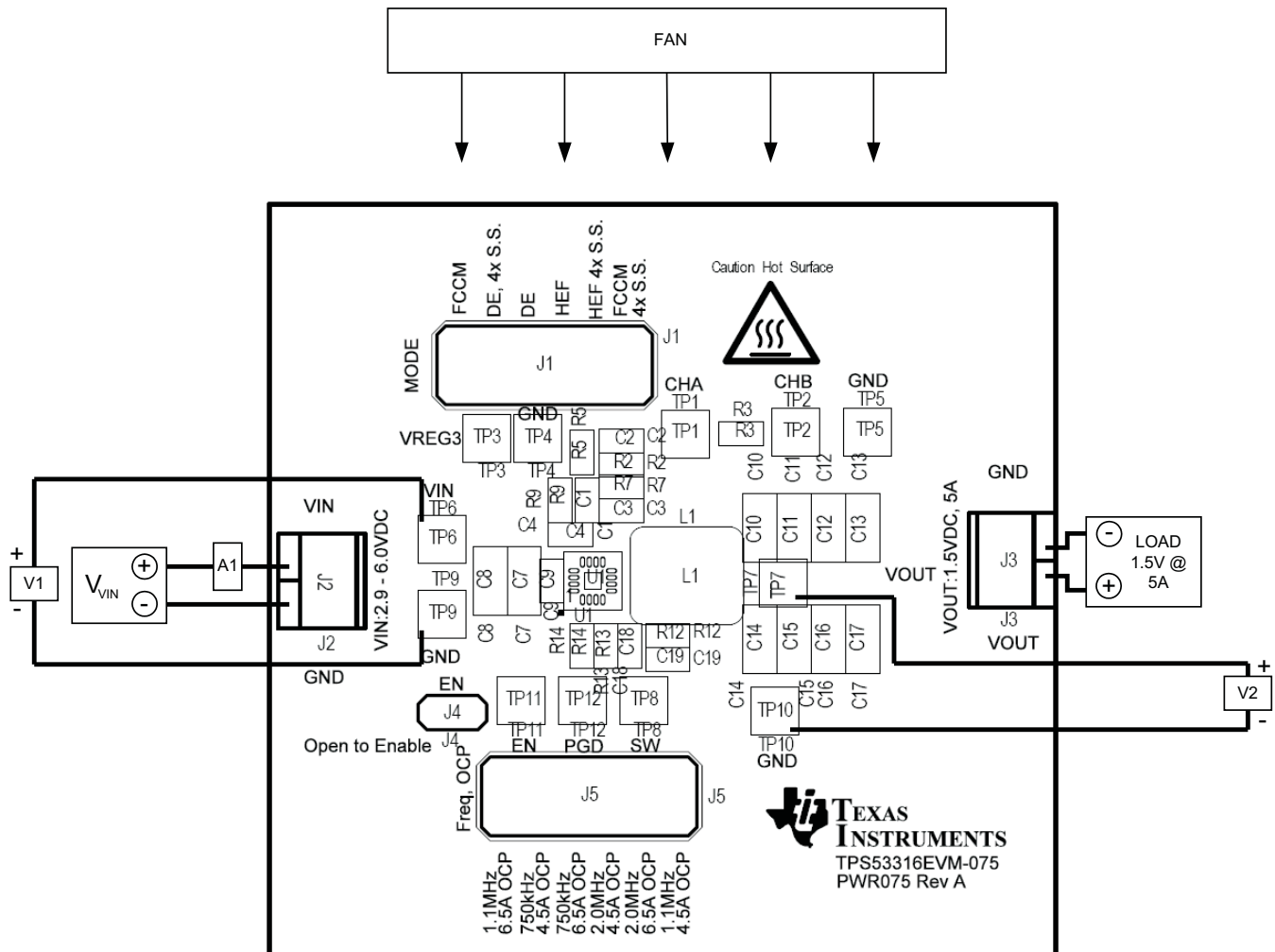

Figure 3. TPS53316EVM-075 Recommended Test Set Up

6 Configurations

The user can configure this EVM per following configurations. Jumper J1 and J5 configurations should be made prior to applying power to the EVM.

6.1 Mode Selection

The MODE can be set by J1.

6.1.1 Default Setting: HEF Mode, 4X S.S. Time

Table 2. MODE Selection

MODE RESISTANCES (k Ω)	MODE
GND	FCCM, 4X S.S. Time
24.3	HEF Mode, 4X S.S. Time
57.6	HEF Mode
105	DE Mode
174	DE Mode, 4X S.S. Time
Open	FCCM

6.2 Enable Selection

The controller can be enabled and disabled by J4.

6.2.1 Default Setting: Short to Disable the Controller

6.3 Switching Frequency and OCP Selection

The switching frequency and OCP threshold can be set by J5.

6.3.1 Default Setting: 750 kHz, 6.5-A OCP

Table 3. Switching Frequency and OCP Selection

MODE RESISTANCES	SWITCHING FREQUENCY	OVERCURRENT THRESHOLD
GND	1.1 MHz	6.5 A
24.3 k Ω	750 kHz	4.5 A
57.6 k Ω	750 kHz	6.5 A
105 k Ω	2.0 MHz	4.5 A
174 k Ω	2.0 MHz	6.5 A
Open	1.1 MHz	4.5 A

7 Test Procedure

7.1 Line/Load Regulation and Efficiency Measurement Procedure

1. Set up EVM as described in [Section 5](#) and [Figure 3](#).
2. Ensure load is set to constant resistance mode and to sink 0 A_{DC}.
3. Ensure all jumpers set per [Section 6](#).
4. Increase VIN from 0 V to 5 V. Using V1 to measure VIN voltage.
5. Open jumper J4 to enable the controller.
6. Use V2 to measure VOUT voltage, A1 to measure VIN current.
7. Vary Load from 0 A_{DC} to 5 A_{DC}, VOUT should remain in load regulation.
8. Vary VIN from 2.9 V to 6.0 V, VOUT should remain in line regulation.
9. Short jumper J4 to disable the controller.
10. Decrease Load to 0 A.
11. Decrease VIN to 0 V.

7.2 Control Loop Gain and Phase Measurement Procedure

TPS53316EVM-075 contains a 10-Ω series resistor in the feedback loop for loop response analysis.

1. Set up EVM as described in [Section 5](#) and [Figure 3](#).
2. Connect isolation transformer to test points marked TP1 and TP2.
3. Connect input signal amplitude measurement probe (channel A) to TP1. Connect output signal amplitude measurement probe (channel B) to TP2.
4. Connect ground lead of channel A and channel B to TP5.
5. Inject around 20-mV or less signal through the isolation transformer.
6. Sweep the frequency from 500 Hz to 500 kHz with 10-Hz or lower post filter. The control loop gain and phase margin can be measured.
7. Disconnect isolation transformer from bode plot test points before making other measurements (signal injection into feedback may interfere with accuracy of other measurements).

7.3 List of Test Points

Table 4. The Functions of Each Test Points

TEST POINTS	NAME	DESCRIPTION
TP1	CHA	Input A for Loop Injection
TP2	CHB	Input B for Loop Injection
TP3	VREG3	3.3-V Internal LDO Output
TP4	GND	GND
TP5	GND	GND
TP6	VIN	Input Voltage
TP7	VOUT	Output Voltage
TP8	SW	Switching Node
TP9	GND	GND
TP10	GND	GND
TP11	EN	Enable Pin
TP12	PGD	Power Good Output

7.4 Equipment Shutdown

1. Shut down VIN.
2. Shut down Load.
3. Shut down FAN.

8 Performance Data and Typical Characteristic Curves

Figure 4 through Figure 19 present typical performance curves for TPS53316EVM-075.

8.1 Efficiency

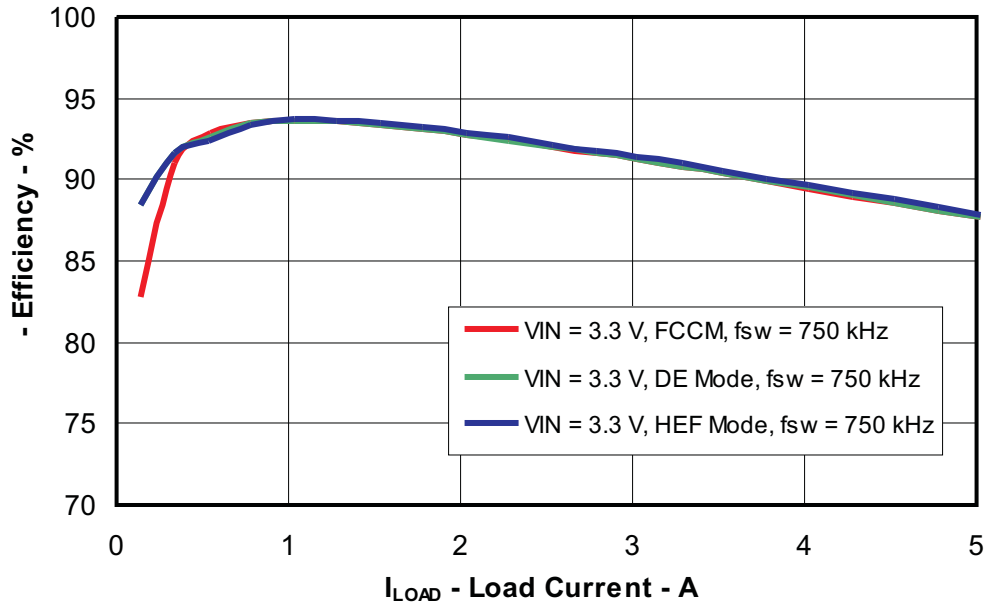

Figure 4. 3.3-V Input Efficiency

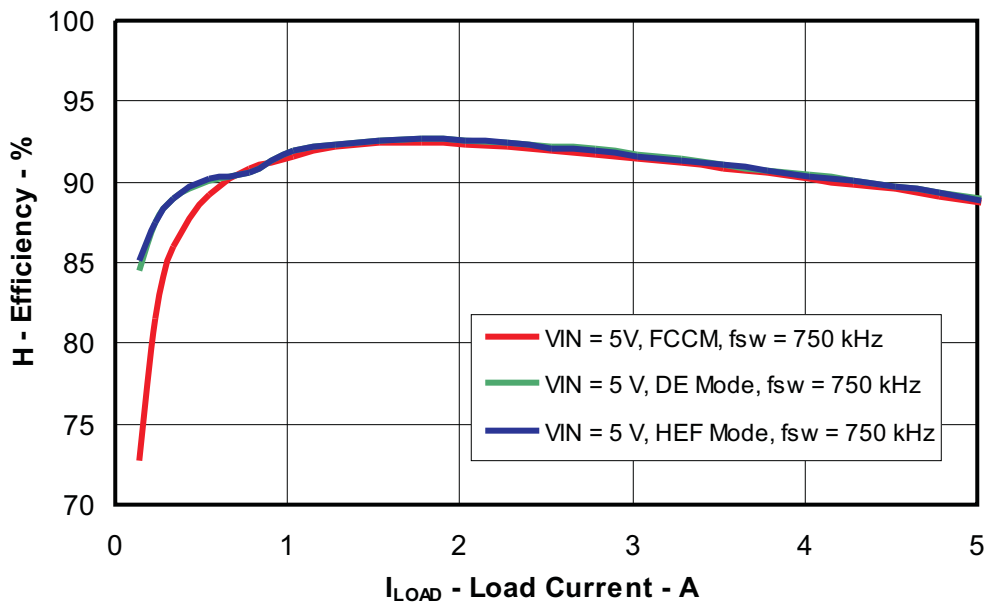

Figure 5. 5-V Input Efficiency

8.2 Load Regulation

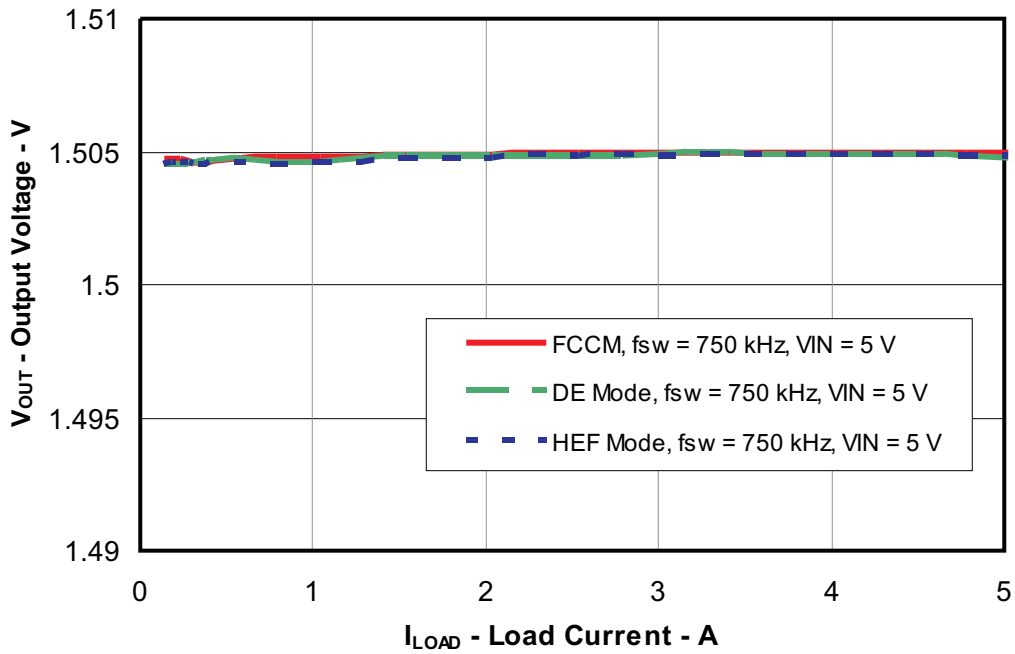

Figure 6. Load Regulation

8.3 Line Regulation

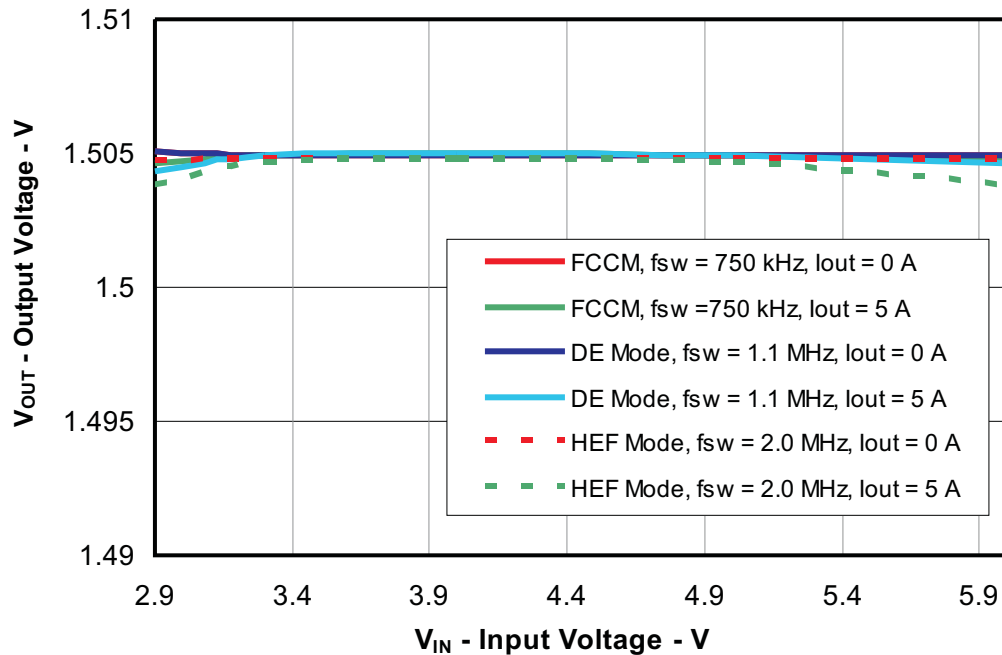

Figure 7. Line Regulation

8.4 Output Transient

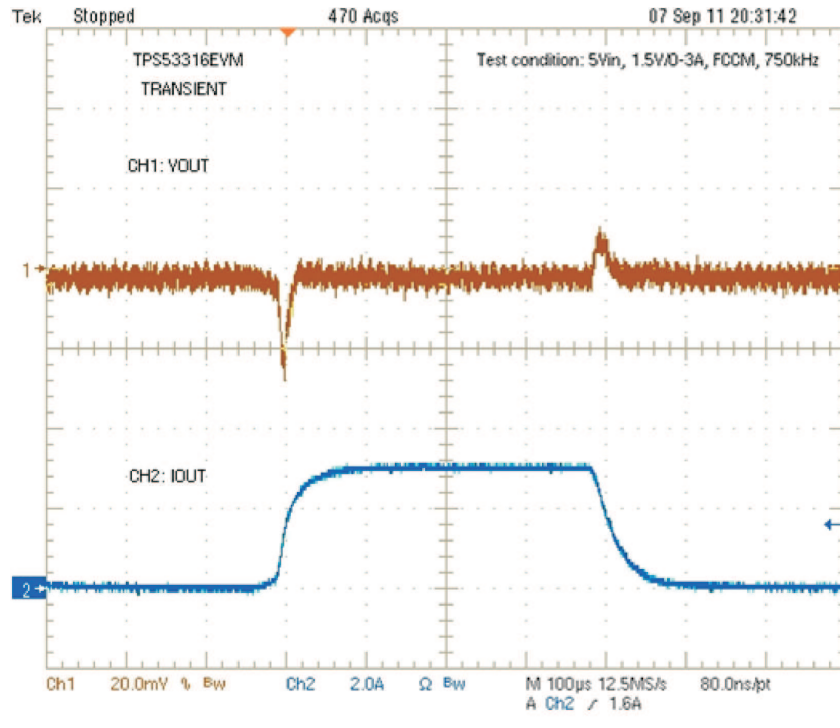

Figure 8. Load 0-3A Transient under FCCM (5-V VIN, 1.5-V VOUT, FCCM, fsw = 750 kHz)

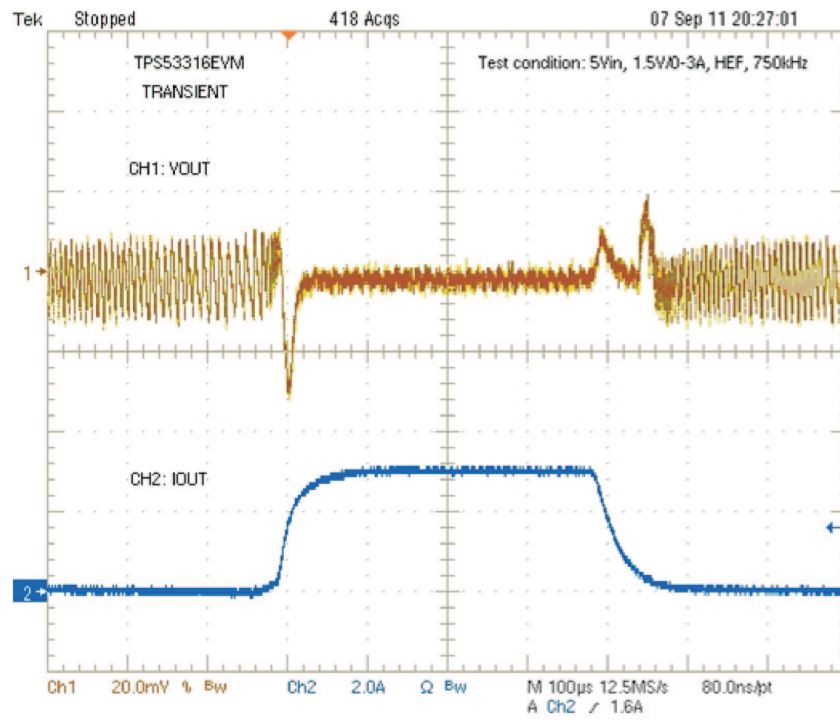
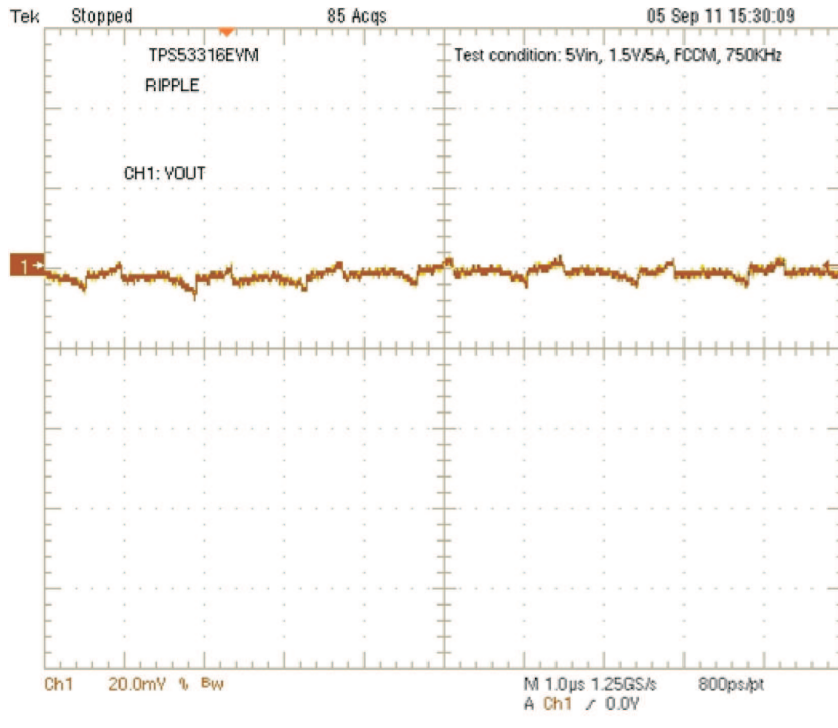
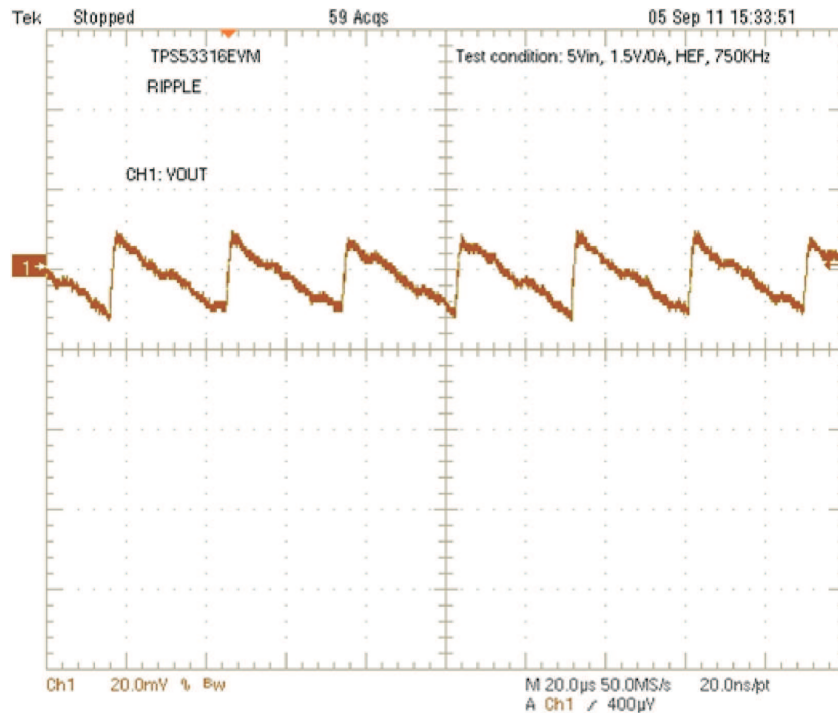

Figure 9. Load 0-3A Transient under HEF Mode (5-V VIN, 1.5-V VOUT, HEF Mode, fsw = 750 kHz)

8.5 Output Ripple



**Figure 10. Output Ripple
(5-V VIN, 1.5-V VOUT, 5-A, FCCM, fsw = 750 kHz)**



**Figure 11. Output Ripple
(5-V VIN, 1.5-V VOUT, 0-A, HEF Mode, fsw = 750 kHz)**

8.6 Switching Node

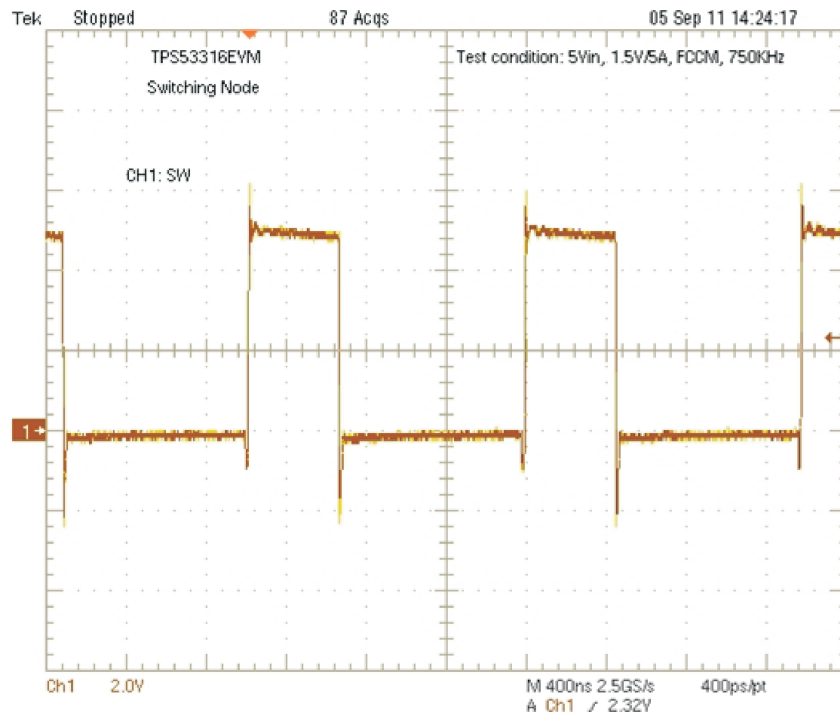

Figure 12. Switching Node
(5-V VIN, 1.5-V VOUT, 5-A, FCCM, fsw = 750 kHz)

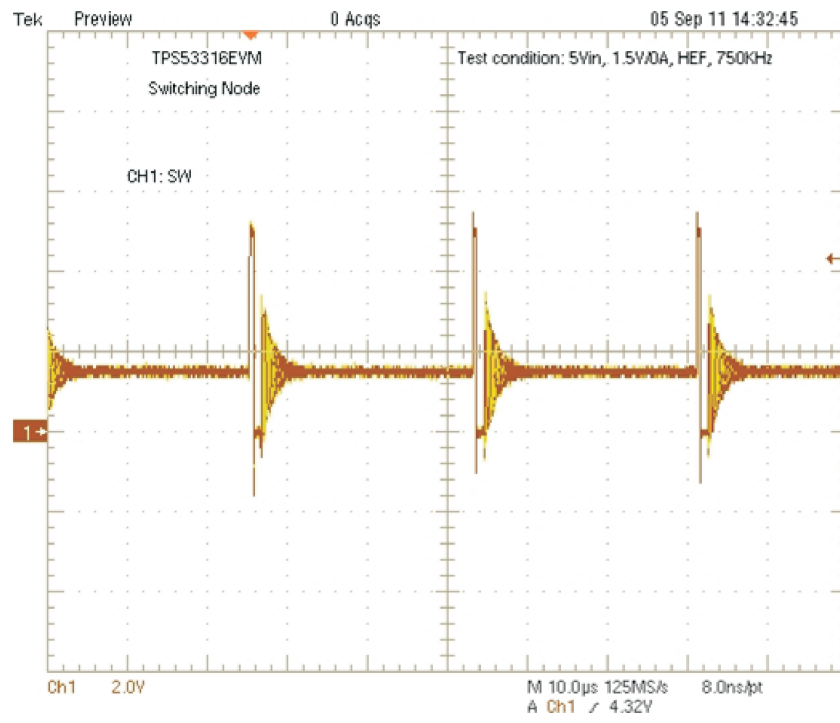
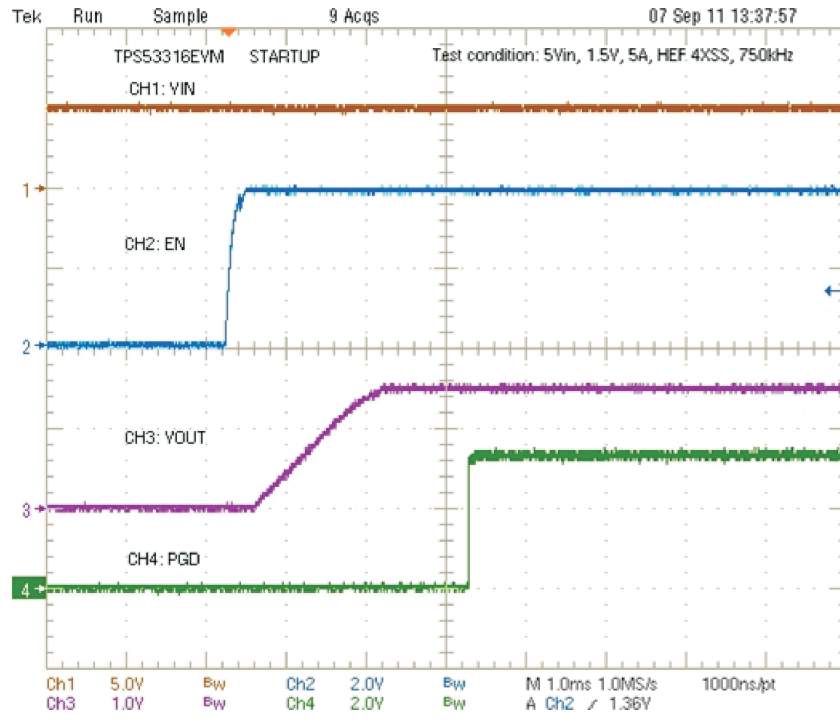
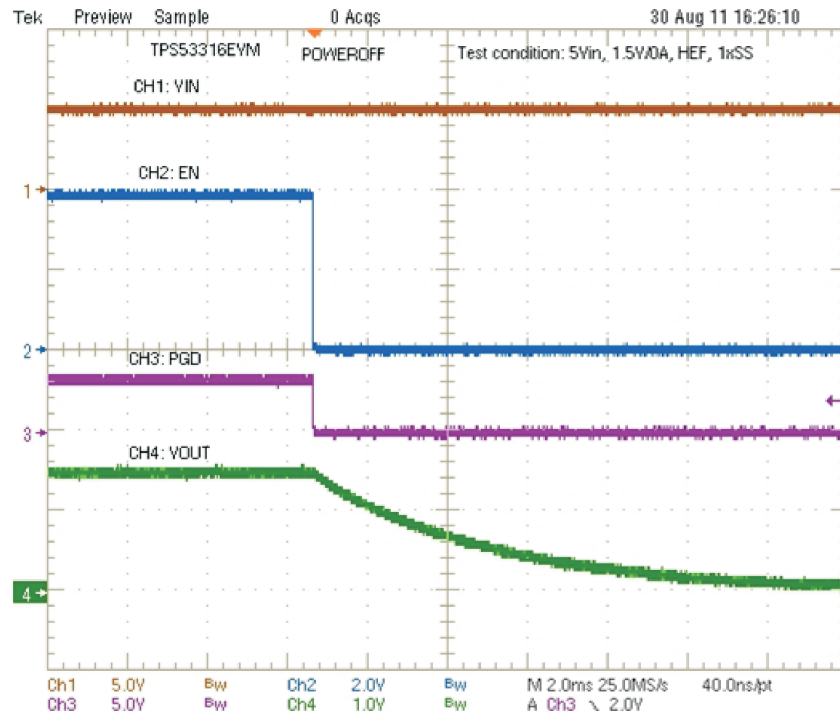

Figure 13. Switching Node
(5-V VIN, 1.5-V VOUT, 0-A, HEF Mode, fsw = 750 kHz)

8.7 Enable Turn On / Turn Off



**Figure 14. Turn-On Waveform
 (5-V VIN, 1.5-V VOUT, 5-A IOUT, 4XS.S.)**



**Figure 15. Turn-Off Waveform
 (5-V VIN, 1.5-V VOUT, 0-A IOUT)**

8.8 Pre-bias Turn-On

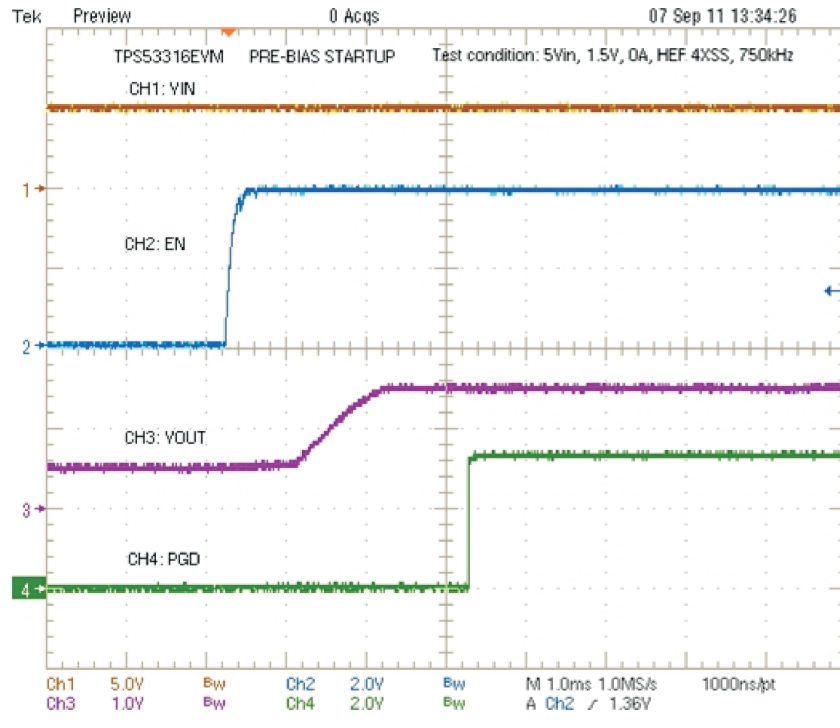

Figure 16. Pre-bias Turn-On Waveform (5-V VIN, 1.5-V VOUT, 0-A IOUT, 4XS.S., 0.5-V pre-bias)

8.9 Overcurrent Protection

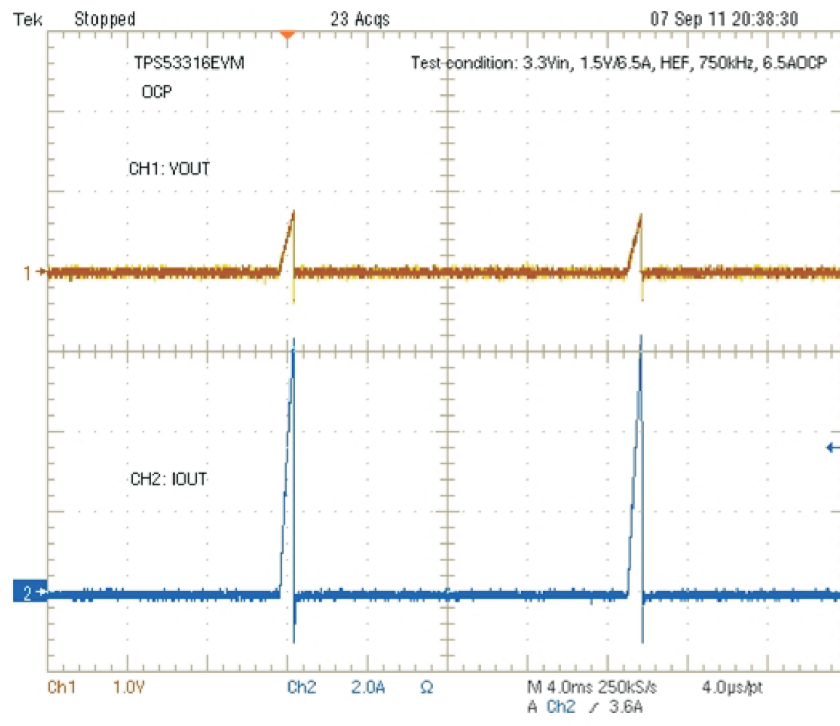

Figure 17. Overcurrent Protection Waveform (3.3-V VIN, 1.5-V VOUT, 6.5-A IOUT, 4XS.S., 750 kHz, 6.5-A OCP)

8.10 Bode Plot

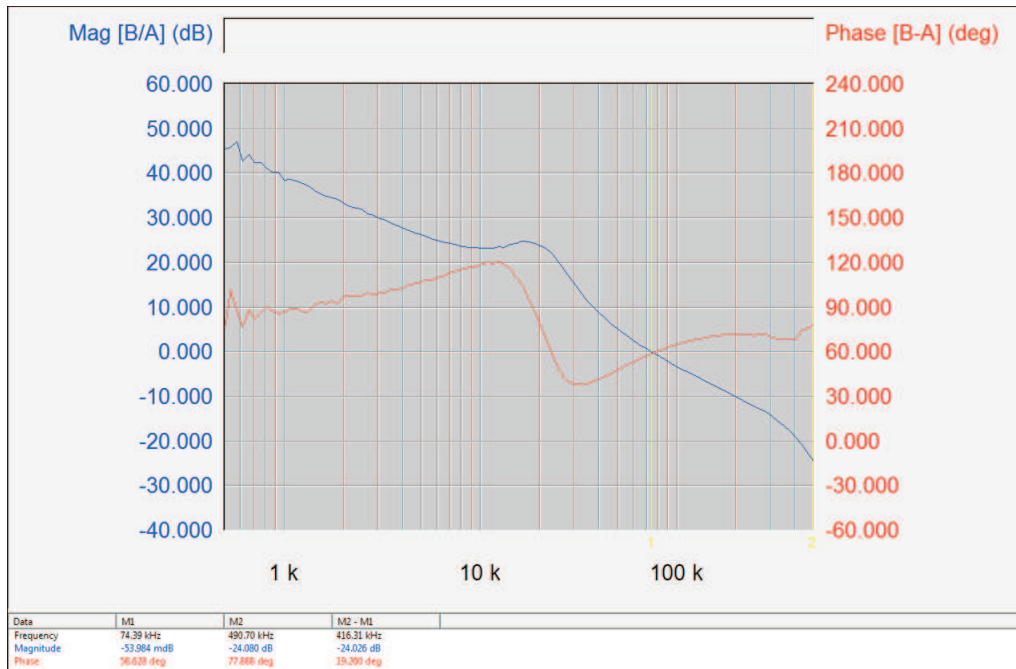

Figure 18. Loop Gain
(5-V VIN, 1.5-V VOUT, 5-A IOU, HEF Mode, $f_{sw} = 750$ kHz)

8.11 Thermal Image

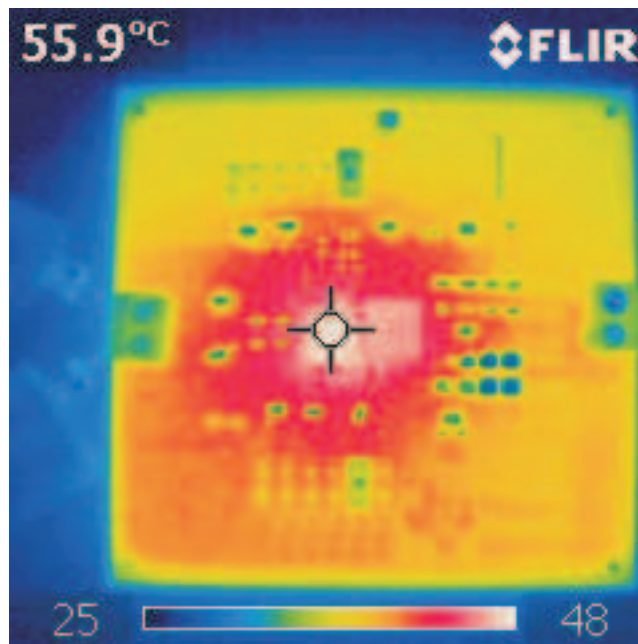

Figure 19. Thermal Image
(6-V VIN, 1.5-V VOUT, 5-A IOU, FCCM Mode, $f_{sw} = 2.0$ MHz)

9 EVM Assembly Drawing and PCB Layout

The following figures (Figure 20 through Figure 25) show the design of the TPS53316EVM-075 printed circuit board. The EVM has been designed using a 4-layer, 2-oz copper circuit board.

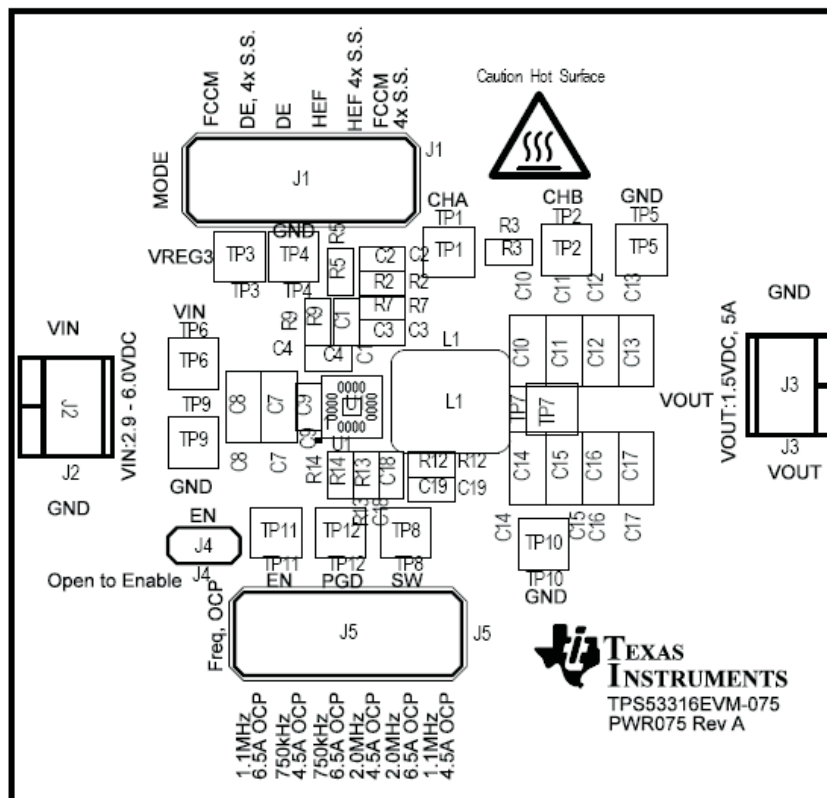

Figure 20. TPS53316EVM-075 Top Layer Assembly Drawing (top view)

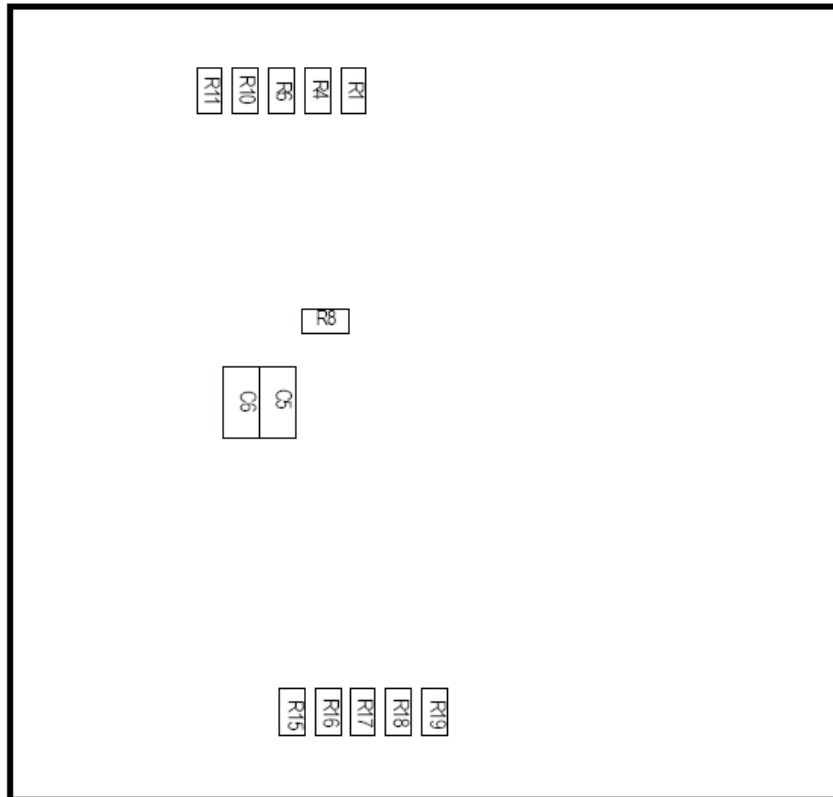

Figure 21. TPS53316EVM-075 Bottom Assembly Drawing (bottom view)

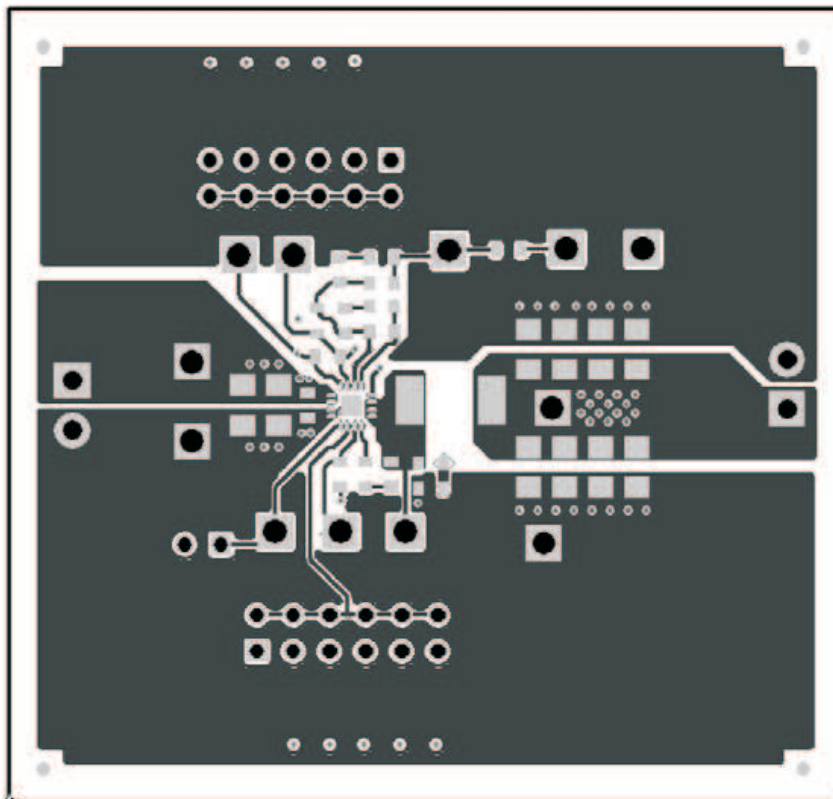

Figure 22. TPS53316EVM-075 Top Copper (top view)

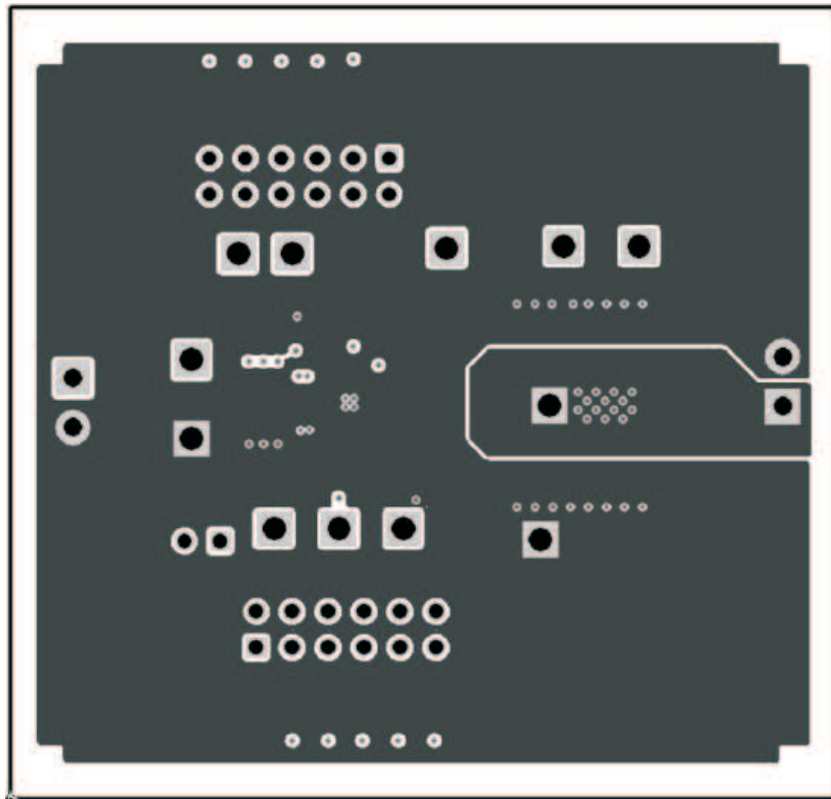

Figure 23. TPS53316EVM-075 Layer 2 (top view)

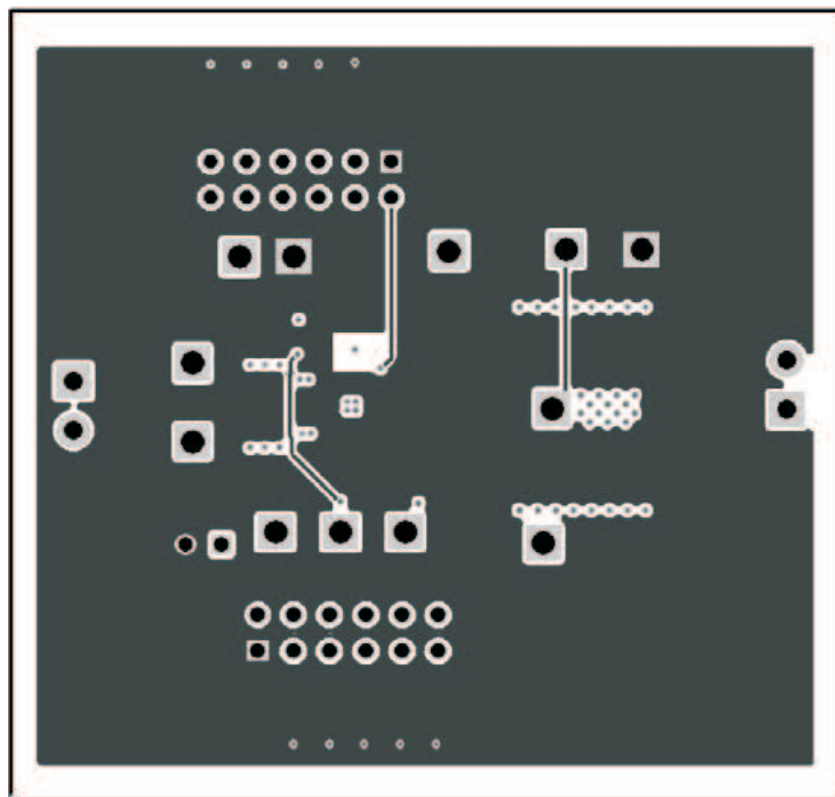

Figure 24. TPS53316EVM-075 Layer 3 (top view)

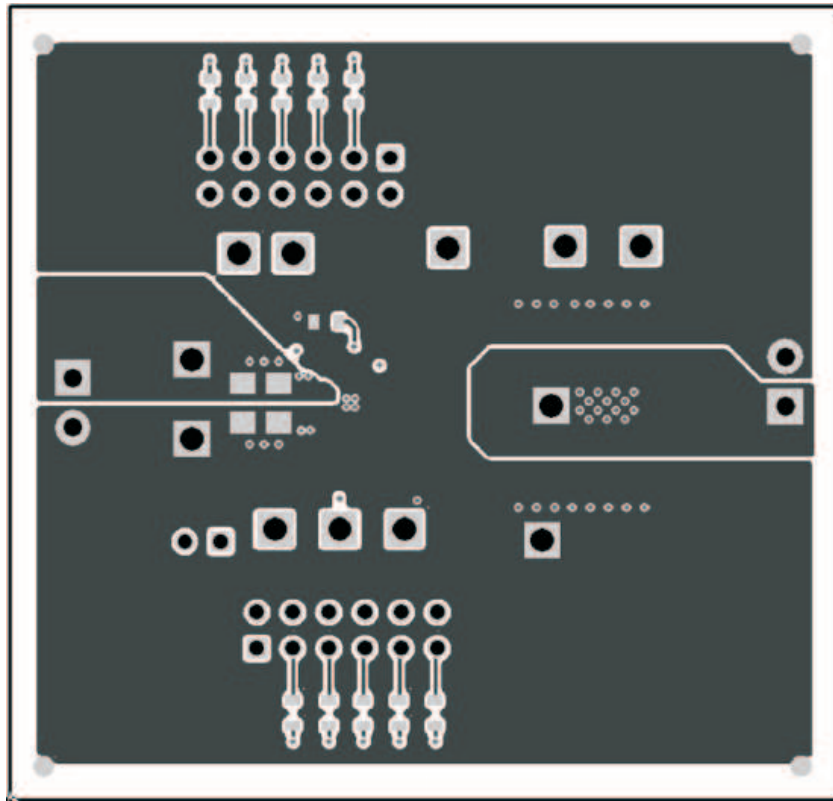

Figure 25. TPS53316EVM-075 Bottom Layer (top view)

10 List of Materials

The EVM components list according to the schematic shown in [Figure 1](#).

Table 5. TPS53316EVM-075 List of Materials

QTY	REF DES	DESCRIPTION	PART NUMBER	MFR
2	C1, C2	Capacitor, ceramic, 50 V, X7R, 10%, 3.3 nF, 603	Std	Std
1	C3	Capacitor, ceramic, 50 V, X7R, 10%, 100 pF, 603	Std	Std
1	C4	Capacitor, ceramic, 16 V, X7R, 15%, 1.0 μ F, 603	Std	Std
0	C5, C6, C14, C15, C16, C17	Capacitor, ceramic, 10 V, X5R, 20%, 1206	Std	Std
6	C7, C8, C10, C11, C12, C13	Capacitor, ceramic, 10 V, X5R, 20%, 22 μ F, 1206	Std	Std
2	C9, C18	Capacitor, ceramic, 16 V, X7R, 10%, 0.1 μ F, 603	Std	Std
1	C19	Capacitor, ceramic, 16 V, X7R, 10%, 1.0 nF, 603	Std	Std
2	J1, J5	Header, male 2 x 6 pin, 100-mil spacing, 0.100 inch x 2 inch x 6 inch	PEC06DAAN	Sullins
2	J2, J3	Terminal block, 2 pin, 6 A, 3.5 mm, 0.27 inch x 0.25 inch	ED555/2DS	OST
1	J4	Header, male 2 pin, 100-mil spacing, 0.100 inch x 2 inch	PEC02SAAN	Sullins
1	L1	Inductor, 1.0 μ H, 5.6 m Ω , power, \pm 20%, 1.0 μ H, 6.6 mm x 7 mm	PCMC065T-1R0MN	Cyntec Co.
2	R1, R15	Resistor, chip, 1/16 W, 1%, 24.3 k Ω , 603	Std	Std
2	R2, R7	Resistor, chip, 1/16 W, 1%, 2.0 k Ω , 603	Std	Std
1	R3	Resistor, chip, 1/16 W, 1%, 10.0 Ω , 603	Std	Std
2	R4, R16	Resistor, chip, 1/16 W, 1%, 57.6 k Ω , 603	Std	Std
1	R5	Resistor, chip, 1/16 W, 1%, 49.9 Ω , 603	Std	Std
2	R6, R17	Resistor, chip, 1/16 W, 1%, 105 k Ω , 603	Std	Std
2	R8, R13	Resistor, chip, 1/16 W, 1%, 0 Ω , 603	Std	Std
1	R9	Resistor, chip, 1/16 W, 1%, 1.33 k Ω , 603	Std	Std
2	R10, R18	Resistor, chip, 1/16 W, 1%, 174 k Ω , 603	Std	Std
0	R11, R19	Resistor, chip, 1/16 W, 1%, 603	Std	Std
1	R12	Resistor, chip, 1/8 W, 1%, 2.0 Ω , 603	Std	Std
1	R14	Resistor, chip, 1/16 W, 1%, 10.0 k Ω , 603	Std	Std
4	TP1, TP2, TP11, TP12	Test point, white, thru hole, 0.125 inch x 0.125 inch	5012	Keystone
4	TP3, TP6, TP7, TP8	Test point, red, thru hole, 0.125 inch x 0.125 inch	5010	Keystone
4	TP4, TP5, TP9, TP10	Test point, black, thru hole, 0.125 inch x 0.125 inch	5011	Keystone
1	U1	5-A Step-down Regulator with Integrated Switcher, QFN-16	TPS53316RGT	TI
3	--	Shunt, 100 mil, black, 0.100 inch	929950-00	3M

Evaluation Board/Kit Important Notice

Texas Instruments (TI) provides the enclosed product(s) under the following conditions:

This evaluation board/kit is intended for use for **ENGINEERING DEVELOPMENT, DEMONSTRATION, OR EVALUATION PURPOSES ONLY** and is not considered by TI to be a finished end-product fit for general consumer use. Persons handling the product(s) must have electronics training and observe good engineering practice standards. As such, the goods being provided are not intended to be complete in terms of required design-, marketing-, and/or manufacturing-related protective considerations, including product safety and environmental measures typically found in end products that incorporate such semiconductor components or circuit boards. This evaluation board/kit does not fall within the scope of the European Union directives regarding electromagnetic compatibility, restricted substances (RoHS), recycling (WEEE), FCC, CE or UL, and therefore may not meet the technical requirements of these directives or other related directives.

Should this evaluation board/kit not meet the specifications indicated in the User's Guide, the board/kit may be returned within 30 days from the date of delivery for a full refund. **THE FOREGOING WARRANTY IS THE EXCLUSIVE WARRANTY MADE BY SELLER TO BUYER AND IS IN LIEU OF ALL OTHER WARRANTIES, EXPRESSED, IMPLIED, OR STATUTORY, INCLUDING ANY WARRANTY OF MERCHANTABILITY OR FITNESS FOR ANY PARTICULAR PURPOSE.**

The user assumes all responsibility and liability for proper and safe handling of the goods. Further, the user indemnifies TI from all claims arising from the handling or use of the goods. Due to the open construction of the product, it is the user's responsibility to take any and all appropriate precautions with regard to electrostatic discharge.

EXCEPT TO THE EXTENT OF THE INDEMNITY SET FORTH ABOVE, NEITHER PARTY SHALL BE LIABLE TO THE OTHER FOR ANY INDIRECT, SPECIAL, INCIDENTAL, OR CONSEQUENTIAL DAMAGES.

TI currently deals with a variety of customers for products, and therefore our arrangement with the user **is not exclusive.**

TI assumes **no liability for applications assistance, customer product design, software performance, or infringement of patents or services described herein.**

Please read the User's Guide and, specifically, the Warnings and Restrictions notice in the User's Guide prior to handling the product. This notice contains important safety information about temperatures and voltages. For additional information on TI's environmental and/or safety programs, please contact the TI application engineer or visit www.ti.com/esh.

No license is granted under any patent right or other intellectual property right of TI covering or relating to any machine, process, or combination in which such TI products or services might be or are used.

FCC Warning

This evaluation board/kit is intended for use for **ENGINEERING DEVELOPMENT, DEMONSTRATION, OR EVALUATION PURPOSES ONLY** and is not considered by TI to be a finished end-product fit for general consumer use. It generates, uses, and can radiate radio frequency energy and has not been tested for compliance with the limits of computing devices pursuant to part 15 of FCC rules, which are designed to provide reasonable protection against radio frequency interference. Operation of this equipment in other environments may cause interference with radio communications, in which case the user at his own expense will be required to take whatever measures may be required to correct this interference.

EVM Warnings and Restrictions

It is important to operate this EVM within the input voltage range of 2.9 VDC to 6.0 VDC and the output voltage range of 0 ADC to 5 ADC.

Exceeding the specified input range may cause unexpected operation and/or irreversible damage to the EVM. If there are questions concerning the input range, please contact a TI field representative prior to connecting the input power.

Applying loads outside of the specified output range may result in unintended operation and/or possible permanent damage to the EVM. Please consult the EVM User's Guide prior to connecting any load to the EVM output. If there is uncertainty as to the load specification, please contact a TI field representative.

During normal operation, some circuit components may have case temperatures greater than 55° C. The EVM is designed to operate properly with certain components above 55° C as long as the input and output ranges are maintained. These components include but are not limited to linear regulators, switching transistors, pass transistors, and current sense resistors. These types of devices can be identified using the EVM schematic located in the EVM User's Guide. When placing measurement probes near these devices during operation, please be aware that these devices may be very warm to the touch.

EVALUATION BOARD/KIT/MODULE (EVM) ADDITIONAL TERMS

Texas Instruments (TI) provides the enclosed Evaluation Board/Kit/Module (EVM) under the following conditions:

The user assumes all responsibility and liability for proper and safe handling of the goods. Further, the user indemnifies TI from all claims arising from the handling or use of the goods.

Should this evaluation board/kit not meet the specifications indicated in the User's Guide, the board/kit may be returned within 30 days from the date of delivery for a full refund. THE FOREGOING LIMITED WARRANTY IS THE EXCLUSIVE WARRANTY MADE BY SELLER TO BUYER AND IS IN LIEU OF ALL OTHER WARRANTIES, EXPRESSED, IMPLIED, OR STATUTORY, INCLUDING ANY WARRANTY OF MERCHANTABILITY OR FITNESS FOR ANY PARTICULAR PURPOSE. EXCEPT TO THE EXTENT OF THE INDEMNITY SET FORTH ABOVE, NEITHER PARTY SHALL BE LIABLE TO THE OTHER FOR ANY INDIRECT, SPECIAL, INCIDENTAL, OR CONSEQUENTIAL DAMAGES.

Please read the User's Guide and, specifically, the Warnings and Restrictions notice in the User's Guide prior to handling the product. This notice contains important safety information about temperatures and voltages. For additional information on TI's environmental and/or safety programs, please visit www.ti.com/esh or contact TI.

No license is granted under any patent right or other intellectual property right of TI covering or relating to any machine, process, or combination in which such TI products or services might be or are used. TI currently deals with a variety of customers for products, and therefore our arrangement with the user is not exclusive. TI assumes no liability for applications assistance, customer product design, software performance, or infringement of patents or services described herein.

REGULATORY COMPLIANCE INFORMATION

As noted in the EVM User's Guide and/or EVM itself, this EVM and/or accompanying hardware may or may not be subject to the Federal Communications Commission (FCC) and Industry Canada (IC) rules.

For EVMs **not** subject to the above rules, this evaluation board/kit/module is intended for use for ENGINEERING DEVELOPMENT, DEMONSTRATION OR EVALUATION PURPOSES ONLY and is not considered by TI to be a finished end product fit for general consumer use. It generates, uses, and can radiate radio frequency energy and has not been tested for compliance with the limits of computing devices pursuant to part 15 of FCC or ICES-003 rules, which are designed to provide reasonable protection against radio frequency interference. Operation of the equipment may cause interference with radio communications, in which case the user at his own expense will be required to take whatever measures may be required to correct this interference.

General Statement for EVMs including a radio

User Power/Frequency Use Obligations: This radio is intended for development/professional use only in legally allocated frequency and power limits. Any use of radio frequencies and/or power availability of this EVM and its development application(s) must comply with local laws governing radio spectrum allocation and power limits for this evaluation module. It is the user's sole responsibility to only operate this radio in legally acceptable frequency space and within legally mandated power limitations. Any exceptions to this are strictly prohibited and unauthorized by Texas Instruments unless user has obtained appropriate experimental/development licenses from local regulatory authorities, which is responsibility of user including its acceptable authorization.

For EVMs annotated as FCC – FEDERAL COMMUNICATIONS COMMISSION Part 15 Compliant

Caution

This device complies with part 15 of the FCC Rules. Operation is subject to the following two conditions: (1) This device may not cause harmful interference, and (2) this device must accept any interference received, including interference that may cause undesired operation.

Changes or modifications not expressly approved by the party responsible for compliance could void the user's authority to operate the equipment.

FCC Interference Statement for Class A EVM devices

This equipment has been tested and found to comply with the limits for a Class A digital device, pursuant to part 15 of the FCC Rules. These limits are designed to provide reasonable protection against harmful interference when the equipment is operated in a commercial environment. This equipment generates, uses, and can radiate radio frequency energy and, if not installed and used in accordance with the instruction manual, may cause harmful interference to radio communications. Operation of this equipment in a residential area is likely to cause harmful interference in which case the user will be required to correct the interference at his own expense.

FCC Interference Statement for Class B EVM devices

This equipment has been tested and found to comply with the limits for a Class B digital device, pursuant to part 15 of the FCC Rules. These limits are designed to provide reasonable protection against harmful interference in a residential installation. This equipment generates, uses and can radiate radio frequency energy and, if not installed and used in accordance with the instructions, may cause harmful interference to radio communications. However, there is no guarantee that interference will not occur in a particular installation. If this equipment does cause harmful interference to radio or television reception, which can be determined by turning the equipment off and on, the user is encouraged to try to correct the interference by one or more of the following measures:

- Reorient or relocate the receiving antenna.
- Increase the separation between the equipment and receiver.
- Connect the equipment into an outlet on a circuit different from that to which the receiver is connected.
- Consult the dealer or an experienced radio/TV technician for help.

For EVMs annotated as IC – INDUSTRY CANADA Compliant

This Class A or B digital apparatus complies with Canadian ICES-003.

Changes or modifications not expressly approved by the party responsible for compliance could void the user's authority to operate the equipment.

Concerning EVMs including radio transmitters

This device complies with Industry Canada licence-exempt RSS standard(s). Operation is subject to the following two conditions: (1) this device may not cause interference, and (2) this device must accept any interference, including interference that may cause undesired operation of the device.

Concerning EVMs including detachable antennas

Under Industry Canada regulations, this radio transmitter may only operate using an antenna of a type and maximum (or lesser) gain approved for the transmitter by Industry Canada. To reduce potential radio interference to other users, the antenna type and its gain should be so chosen that the equivalent isotropically radiated power (e.i.r.p.) is not more than that necessary for successful communication.

This radio transmitter has been approved by Industry Canada to operate with the antenna types listed in the user guide with the maximum permissible gain and required antenna impedance for each antenna type indicated. Antenna types not included in this list, having a gain greater than the maximum gain indicated for that type, are strictly prohibited for use with this device.

Cet appareil numérique de la classe A ou B est conforme à la norme NMB-003 du Canada.

Les changements ou les modifications pas expressément approuvés par la partie responsable de la conformité ont pu vider l'autorité de l'utilisateur pour actionner l'équipement.

Concernant les EVMs avec appareils radio

Le présent appareil est conforme aux CNR d'Industrie Canada applicables aux appareils radio exempts de licence. L'exploitation est autorisée aux deux conditions suivantes : (1) l'appareil ne doit pas produire de brouillage, et (2) l'utilisateur de l'appareil doit accepter tout brouillage radioélectrique subi, même si le brouillage est susceptible d'en compromettre le fonctionnement.

Concernant les EVMs avec antennes détachables

Conformément à la réglementation d'Industrie Canada, le présent émetteur radio peut fonctionner avec une antenne d'un type et d'un gain maximal (ou inférieur) approuvé pour l'émetteur par Industrie Canada. Dans le but de réduire les risques de brouillage radioélectrique à l'intention des autres utilisateurs, il faut choisir le type d'antenne et son gain de sorte que la puissance isotrope rayonnée équivalente (p.i.r.e.) ne dépasse pas l'intensité nécessaire à l'établissement d'une communication satisfaisante.

Le présent émetteur radio a été approuvé par Industrie Canada pour fonctionner avec les types d'antenne énumérés dans le manuel d'usage et ayant un gain admissible maximal et l'impédance requise pour chaque type d'antenne. Les types d'antenne non inclus dans cette liste, ou dont le gain est supérieur au gain maximal indiqué, sont strictement interdits pour l'exploitation de l'émetteur.

【Important Notice for Users of this Product in Japan】

This development kit is NOT certified as Confirming to Technical Regulations of Radio Law of Japan

If you use this product in Japan, you are required by Radio Law of Japan to follow the instructions below with respect to this product:

1. Use this product in a shielded room or any other test facility as defined in the notification #173 issued by Ministry of Internal Affairs and Communications on March 28, 2006, based on Sub-section 1.1 of Article 6 of the Ministry's Rule for Enforcement of Radio Law of Japan,
2. Use this product only after you obtained the license of Test Radio Station as provided in Radio Law of Japan with respect to this product, or
3. Use of this product only after you obtained the Technical Regulations Conformity Certification as provided in Radio Law of Japan with respect to this product. Also, please do not transfer this product, unless you give the same notice above to the transferee. Please note that if you could not follow the instructions above, you will be subject to penalties of Radio Law of Japan.

Texas Instruments Japan Limited
(address) 24-1, Nishi-Shinjuku 6 chome, Shinjuku-ku, Tokyo, Japan

<http://www.tij.co.jp>

【ご使用にあたっての注】

本開発キットは技術基準適合証明を受けておりません。

本製品のご使用に際しては、電波法遵守のため、以下のいずれかの措置を取っていただく必要がありますのでご注意ください。

1. 電波法施行規則第6条第1項第1号に基づく平成18年3月28日総務省告示第173号で定められた電波暗室等の試験設備でご使用いただく。
2. 実験局の免許を取得後ご使用いただく。
3. 技術基準適合証明を取得後ご使用いただく。

なお、本製品は、上記の「ご使用にあたっての注意」を譲渡先、移転先に通知しない限り、譲渡、移転できないものとします。

上記を遵守頂けない場合は、電波法の罰則が適用される可能性があることをご留意ください。

日本テキサス・インスツルメンツ株式会社
東京都新宿区西新宿6丁目24番1号
西新宿三井ビル

<http://www.tij.co.jp>

EVALUATION BOARD/KIT/MODULE (EVM) WARNINGS, RESTRICTIONS AND DISCLAIMERS

For Feasibility Evaluation Only, in Laboratory/Development Environments. Unless otherwise indicated, this EVM is not a finished electrical equipment and not intended for consumer use. It is intended solely for use for preliminary feasibility evaluation in laboratory/development environments by technically qualified electronics experts who are familiar with the dangers and application risks associated with handling electrical mechanical components, systems and subsystems. It should not be used as all or part of a finished end product.

Your Sole Responsibility and Risk. You acknowledge, represent and agree that:

1. You have unique knowledge concerning Federal, State and local regulatory requirements (including but not limited to Food and Drug Administration regulations, if applicable) which relate to your products and which relate to your use (and/or that of your employees, affiliates, contractors or designees) of the EVM for evaluation, testing and other purposes.
2. You have full and exclusive responsibility to assure the safety and compliance of your products with all such laws and other applicable regulatory requirements, and also to assure the safety of any activities to be conducted by you and/or your employees, affiliates, contractors or designees, using the EVM. Further, you are responsible to assure that any interfaces (electronic and/or mechanical) between the EVM and any human body are designed with suitable isolation and means to safely limit accessible leakage currents to minimize the risk of electrical shock hazard.
3. You will employ reasonable safeguards to ensure that your use of the EVM will not result in any property damage, injury or death, even if the EVM should fail to perform as described or expected.
4. You will take care of proper disposal and recycling of the EVM's electronic components and packing materials.

Certain Instructions. It is important to operate this EVM within TI's recommended specifications and environmental considerations per the user guidelines. Exceeding the specified EVM ratings (including but not limited to input and output voltage, current, power, and environmental ranges) may cause property damage, personal injury or death. If there are questions concerning these ratings please contact a TI field representative prior to connecting interface electronics including input power and intended loads. Any loads applied outside of the specified output range may result in unintended and/or inaccurate operation and/or possible permanent damage to the EVM and/or interface electronics. Please consult the EVM User's Guide prior to connecting any load to the EVM output. If there is uncertainty as to the load specification, please contact a TI field representative. During normal operation, some circuit components may have case temperatures greater than 60°C as long as the input and output are maintained at a normal ambient operating temperature. These components include but are not limited to linear regulators, switching transistors, pass transistors, and current sense resistors which can be identified using the EVM schematic located in the EVM User's Guide. When placing measurement probes near these devices during normal operation, please be aware that these devices may be very warm to the touch. As with all electronic evaluation tools, only qualified personnel knowledgeable in electronic measurement and diagnostics normally found in development environments should use these EVMs.

Agreement to Defend, Indemnify and Hold Harmless. You agree to defend, indemnify and hold TI, its licensors and their representatives harmless from and against any and all claims, damages, losses, expenses, costs and liabilities (collectively, "Claims") arising out of or in connection with any use of the EVM that is not in accordance with the terms of the agreement. This obligation shall apply whether Claims arise under law of tort or contract or any other legal theory, and even if the EVM fails to perform as described or expected.

Safety-Critical or Life-Critical Applications. If you intend to evaluate the components for possible use in safety critical applications (such as life support) where a failure of the TI product would reasonably be expected to cause severe personal injury or death, such as devices which are classified as FDA Class III or similar classification, then you must specifically notify TI of such intent and enter into a separate Assurance and Indemnity Agreement.

Mailing Address: Texas Instruments, Post Office Box 655303, Dallas, Texas 75265
Copyright © 2012, Texas Instruments Incorporated

IMPORTANT NOTICE

Texas Instruments Incorporated and its subsidiaries (TI) reserve the right to make corrections, enhancements, improvements and other changes to its semiconductor products and services per JESD46, latest issue, and to discontinue any product or service per JESD48, latest issue. Buyers should obtain the latest relevant information before placing orders and should verify that such information is current and complete. All semiconductor products (also referred to herein as "components") are sold subject to TI's terms and conditions of sale supplied at the time of order acknowledgment.

TI warrants performance of its components to the specifications applicable at the time of sale, in accordance with the warranty in TI's terms and conditions of sale of semiconductor products. Testing and other quality control techniques are used to the extent TI deems necessary to support this warranty. Except where mandated by applicable law, testing of all parameters of each component is not necessarily performed.

TI assumes no liability for applications assistance or the design of Buyers' products. Buyers are responsible for their products and applications using TI components. To minimize the risks associated with Buyers' products and applications, Buyers should provide adequate design and operating safeguards.

TI does not warrant or represent that any license, either express or implied, is granted under any patent right, copyright, mask work right, or other intellectual property right relating to any combination, machine, or process in which TI components or services are used. Information published by TI regarding third-party products or services does not constitute a license to use such products or services or a warranty or endorsement thereof. Use of such information may require a license from a third party under the patents or other intellectual property of the third party, or a license from TI under the patents or other intellectual property of TI.

Reproduction of significant portions of TI information in TI data books or data sheets is permissible only if reproduction is without alteration and is accompanied by all associated warranties, conditions, limitations, and notices. TI is not responsible or liable for such altered documentation. Information of third parties may be subject to additional restrictions.

Resale of TI components or services with statements different from or beyond the parameters stated by TI for that component or service voids all express and any implied warranties for the associated TI component or service and is an unfair and deceptive business practice. TI is not responsible or liable for any such statements.

Buyer acknowledges and agrees that it is solely responsible for compliance with all legal, regulatory and safety-related requirements concerning its products, and any use of TI components in its applications, notwithstanding any applications-related information or support that may be provided by TI. Buyer represents and agrees that it has all the necessary expertise to create and implement safeguards which anticipate dangerous consequences of failures, monitor failures and their consequences, lessen the likelihood of failures that might cause harm and take appropriate remedial actions. Buyer will fully indemnify TI and its representatives against any damages arising out of the use of any TI components in safety-critical applications.

In some cases, TI components may be promoted specifically to facilitate safety-related applications. With such components, TI's goal is to help enable customers to design and create their own end-product solutions that meet applicable functional safety standards and requirements. Nonetheless, such components are subject to these terms.

No TI components are authorized for use in FDA Class III (or similar life-critical medical equipment) unless authorized officers of the parties have executed a special agreement specifically governing such use.

Only those TI components which TI has specifically designated as military grade or "enhanced plastic" are designed and intended for use in military/aerospace applications or environments. Buyer acknowledges and agrees that any military or aerospace use of TI components which have **not** been so designated is solely at the Buyer's risk, and that Buyer is solely responsible for compliance with all legal and regulatory requirements in connection with such use.

TI has specifically designated certain components which meet ISO/TS16949 requirements, mainly for automotive use. Components which have not been so designated are neither designed nor intended for automotive use; and TI will not be responsible for any failure of such components to meet such requirements.

Products

Audio	www.ti.com/audio
Amplifiers	amplifier.ti.com
Data Converters	dataconverter.ti.com
DLP® Products	www.dlp.com
DSP	dsp.ti.com
Clocks and Timers	www.ti.com/clocks
Interface	interface.ti.com
Logic	logic.ti.com
Power Mgmt	power.ti.com
Microcontrollers	microcontroller.ti.com
RFID	www.ti-rfid.com
OMAP Applications Processors	www.ti.com/omap
Wireless Connectivity	www.ti.com/wirelessconnectivity

Applications

Automotive and Transportation	www.ti.com/automotive
Communications and Telecom	www.ti.com/communications
Computers and Peripherals	www.ti.com/computers
Consumer Electronics	www.ti.com/consumer-apps
Energy and Lighting	www.ti.com/energy
Industrial	www.ti.com/industrial
Medical	www.ti.com/medical
Security	www.ti.com/security
Space, Avionics and Defense	www.ti.com/space-avionics-defense
Video and Imaging	www.ti.com/video

TI E2E Community

e2e.ti.com