



EVQ4210-U-00B

40V, 100W Synchronous Buck-Boost Controller with I²C and Current Monitor, AEC-Q100 Qualified

DESCRIPTION

The EVQ4210-U-00B Evaluation Board is designed to demonstrate the capabilities of MPS' MPQ4210GU-AEC1.

The MPQ4210 is a synchronous, four-switch, buck-boost controller capable of regulating different output voltages with a wide input voltage range and high efficiency. It provides an I²C interface, which supports V_{OUT} voltage programmability, V_{OUT} slew-rate control, and output constant current limit programmability, making the MPQ4210 suitable for USB power delivery (PD) design in USB Type-C power supplies.

The MPQ4210 uses valley current control in buck mode and peak current control in boost mode, providing fast load transient response and smooth buck-boost mode transient. The MPQ4210 provides forced continuous conduction mode (FCCM) and a programmable average current limit, which supports flexible designs for different applications.

It also features programmable over-current protection (OCP) mode, programmable over-voltage protection (OVP) mode, and programmable V_{IN} UVLO hysteresis.

The MPQ4210 is available in a QFN-27 (5mmx5mm) package.

ELECTRICAL SPECIFICATION

Parameter	Symbol	Value	Units
Input Voltage ⁽¹⁾	V _{IN}	6 – 40	V
Output Voltage ⁽²⁾	V _{OUT}	Default: 5	V
Output Current ⁽³⁾	I _{OUT}	0 – 5	A

FEATURES

- 6V to 40V Start-Up Input Voltage Range
- 5V to 40V Operation Input Voltage Range
- Flexible I²C Interface Control for:
 - 0.5V to 28V Output Voltage Range
 - 0.3V to 2.047V Reference Voltage Range with 1mV Step
 - Selectable V_{OUT} Slew Rate
 - Programmable Constant Current Limit
- Output Current Monitor Function (IMON)
- Programmable Soft-Start Time
- Switching Frequency Spread Spectrum for EMI Optimization
- Integrated V_{OUT} Discharge Function
- Selectable 200kHz, 300kHz, 400kHz, and 600kHz Switching Frequency
- Forced CCM Operation Mode
- Programmable V_{IN} UVLO Hysteresis
- OCP, SCP, and OVP
- Interrupt Indicator for OCP, OVP, and PNG
- Available in a QFN-27 (5mmx5mm) Package with Wettable Flank
- AEC-Q100 Qualified

APPLICATIONS

- USB Power Delivery
- Industrial PC Power Supplies
- Super-Capacitor Charging

All MPS parts are lead-free, halogen-free, and adhere to the RoHS directive. For MPS green status, please visit the MPS website under Quality Assurance. "MPS" and "The Future of Analog IC Technology" are registered trademarks of Monolithic Power Systems, Inc.

Note:

(1) V_{IN} must be 6V or higher to enable this board. After startup, it can work with 5V input voltage.

(2) EVQ4214-U-00B is default off. Using I²C interface to set board on.

(3) Default current limit is 3A. Using I²C interface to set current limit if load current > 3A.

EVQ4210-U-00B EVALUATION BOARD

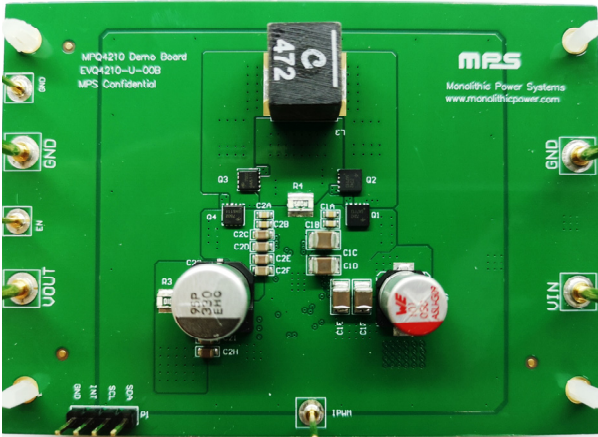

(L × W) 9.14cm x 6.6cm

Board Number	MPS IC Number
EVQ4210-U-00B	MPQ4210GU-AEC1

Efficiency vs. Load

V_{IN}=12V

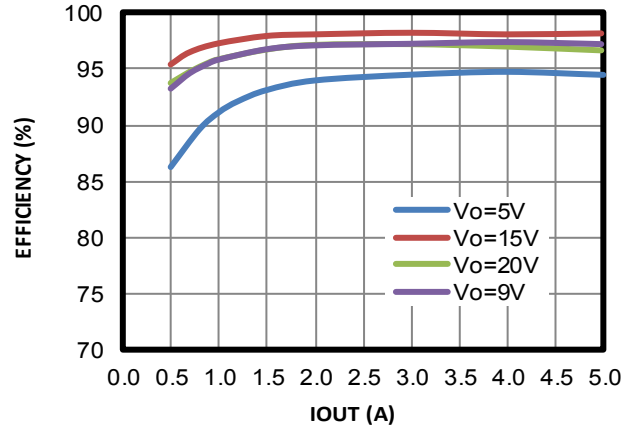

EVALUATION BOARD SCHEMATIC

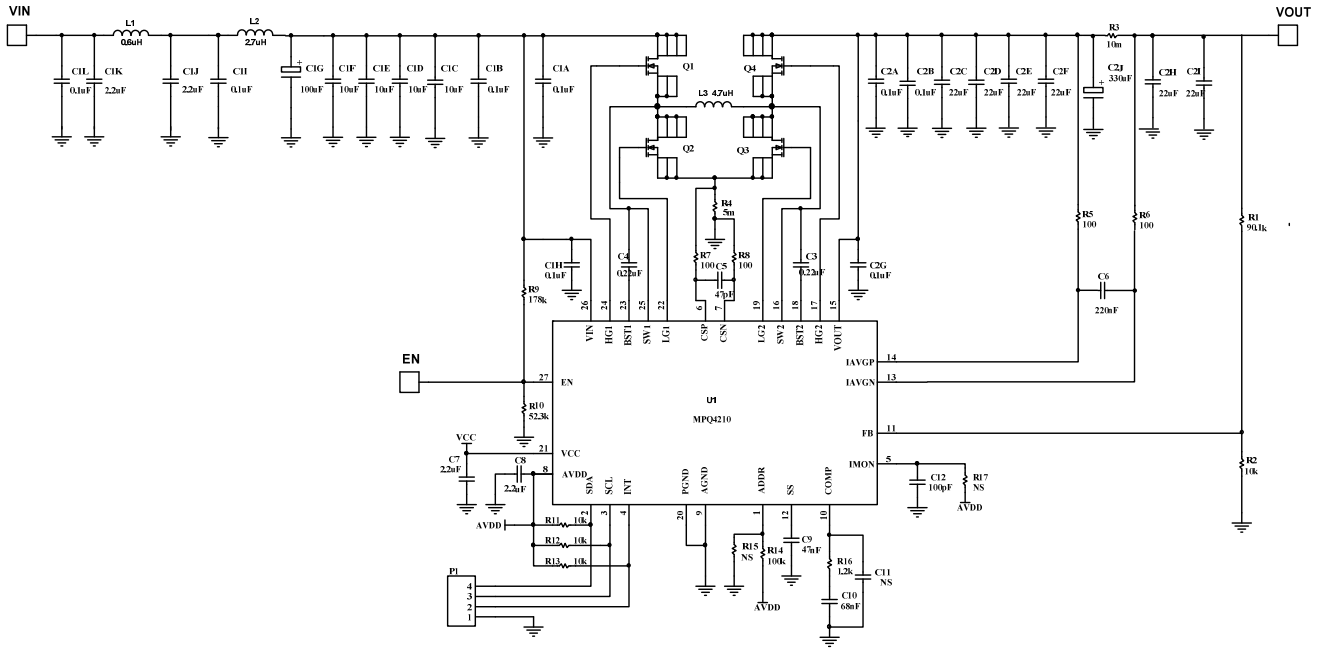

EVQ4210-U-00B BILL OF MATERIALS

Qty	Ref	Value	Description	Package	Manufacturer	Manufacturer PN
8	C1A, C1B, C1H, C1I, C1L, C2A, C2B, C2G	100nF	Ceramic Cap.,50V,X7R	0603	Murata	GRM188R71H104KA93D
1	C2J	330µF	330µF/25V, 80mΩ	SMD	NIPPON CHEMI-CON	EMZJ250ADA331MHAOG
4	C1C, C1D, C1E, C1F	10µF	Ceramic Cap.,50V,X7R	1210	Murata	GRM32ER71H106KA12L
1	C1G	100µF	Alum-electrolytic Cap. 50V,460mΩ, 0.35A	SMD	Wurth	865080653016
2	C1J, C1K	2.2µF	Ceramic Cap.,50V,X7R	1210	Murata	GRM32ER71H225KL
6	C2C, C2D, C2E, C2F, C2H, C2I	22µF	Ceramic Cap.,25V,X5R	0805	Murata	GRM21BR61E226ME44L
3	C3, C4, C6	220nF	Ceramic Cap.,16V,X7R	0603	Murata	GRM188R71C224KA01D
1	C5	47pF	Ceramic Cap.,50V,C0G	0603	Murata	GRM1885C1H470JA01D
1	C7	2.2µF	Ceramic Cap.,16V,X7R	0805	Murata	GRM21BR71C225KA12L
1	C8	2.2µF	Ceramic Cap.,10V,X7R	0603	Murata	GRM188R71A225KE15D
1	C9	47nF	Ceramic Cap.,16V,X7R	0603	Murata	GRM188R71C473KA01D
1	C10	68nF	Ceramic Cap.,50V,X7R	0603	TDK	C1608X7R1H683KT000N
0	C11	NS				
1	C12	100pF	Ceramic Cap,50V,C0G	0603	Murata	GRM1885C1H101JA01D
1	L3	4.7µH	4.7µH inductor	SMD	Coilcraft	XAL1010-472MED
1	L1	0.6µH	Inductor, DCR=4.11mΩ,Isat=19.8A	SMD	Coilcraft	XAL5030-601MEC
1	L2	2.7µH	2.7µH inductor	SMD	Coilcraft	XEL6060-272MEC
1	P1	4PINS	4Pins,1 row,straight	DIP	WE	61300411121
2	Q1, Q2	AON72 42	40V, 3.2mΩ, 50A, 26.5nC, N-channel Mosfet	DFN 3.3x3.3 EP	AOS	AON7242
2	Q3, Q4	AON75 02	30V, 3.9mΩ, 30A, 15.6nC, N-channel Mosfet	DFN 3 x3 EP	AOS	AON7502
1	R1	90K9	Film Res,1%	0603	YAGEO	RC0603FR-0790K9L
4	R2, R11, R12, R13	10K	Film Res,1%	0603	YAGEO	RC0603FR-0710KL
1	R4	5m	SMD 1W 0.005Ω 1%	L1508	Susumu	RL3720WT-R005-F
1	R3	10m	Film Res,1%,1W,0.01R	L1508	Susumu	RL3720WT-R010-F
4	R5, R6, R7, R8	100R	Film Res,1%	0603	YAGEO	RC0603FR-07100RL
1	R9	178K	Film Res,1%	0603	YAGEO	RC0603FR-07178KL
1	R14	100K	Film Res,1%	0603	YAGEO	RC0603FR-07100KL
1	R10	52K3	Film Res,1%	0603	YAGEO	RC0603FR-0752K3L
0	R15, R17	NS				
1	R16	1K2	Film Res,1%	0603	YAGEO	RC0603FR-071K2L
1	U1	MPQ42 10	40V Synchronous Buck-Boost Controller with I2C	QFN-27(5x5)	MPS	MPQ4210GU-AEC1

EVB TEST RESULTS

Performance curves and waveforms are tested on the evaluation board.

V_{IN} = 12V, V_{OUT} = 5V, L = 4.7μH, T_A = +25°C, unless otherwise noted.

Efficiency vs. Load

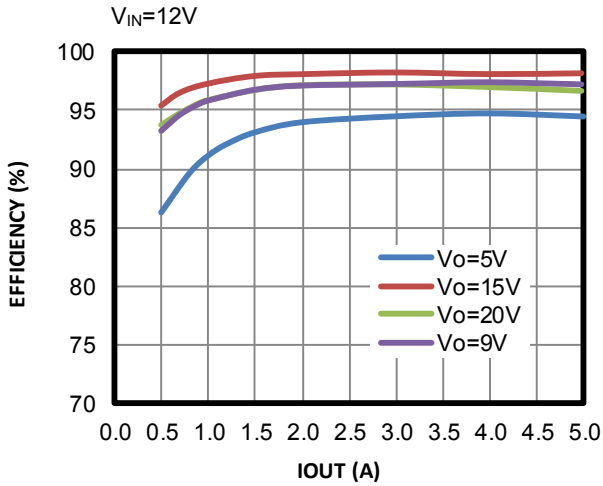

Load Regulation

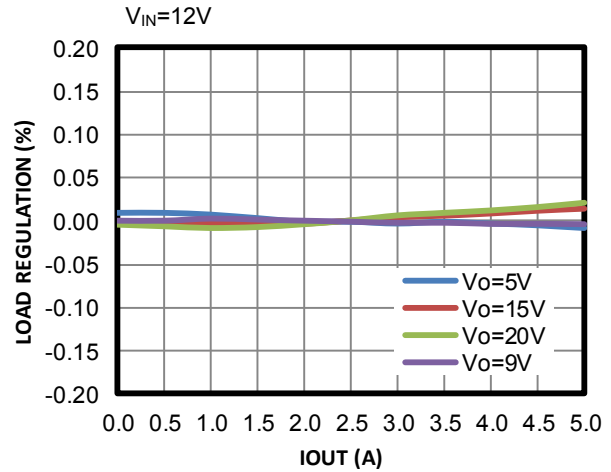

Vo=5V Line Regulation

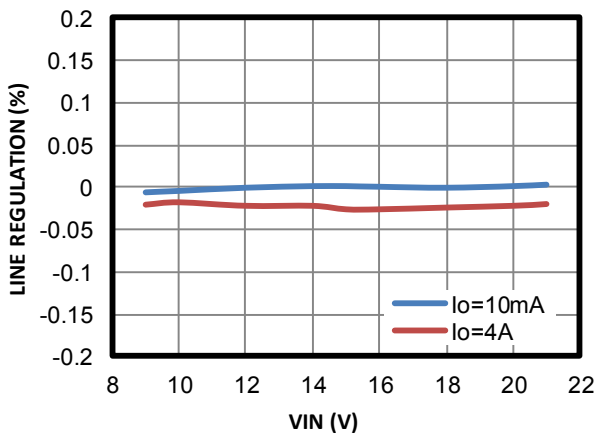

Vout=9V Line Regulation

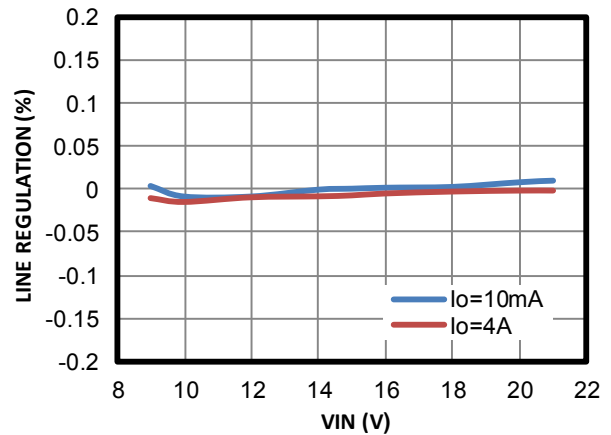

Vout=15V Line Regulation

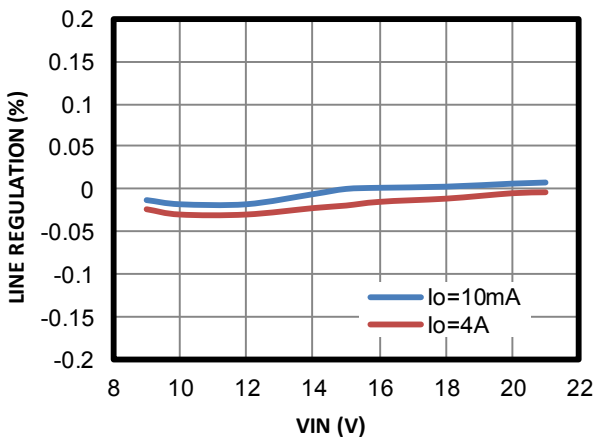

Vout=20V Line Regulation

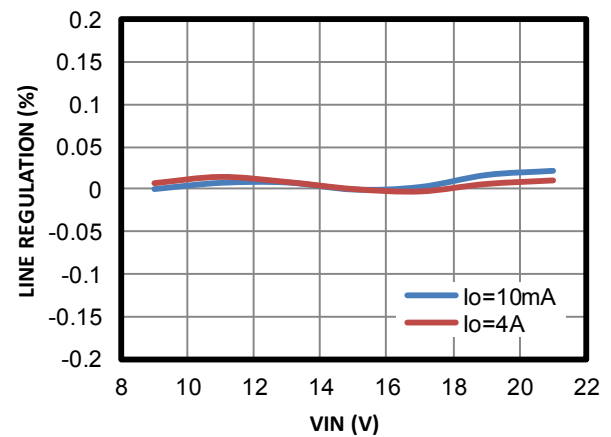

EVB TEST RESULTS (continued)

Performance curves and waveforms are tested on the evaluation board.

V_{IN} = 12V, V_{OUT} = 5V, L = 4.7μH, T_A = +25°C, unless otherwise noted.

Bode Plot

V_{OUT} = 5V, I_{OUT} = 3A, BW = 3.06kHz,
PM = 73.73deg

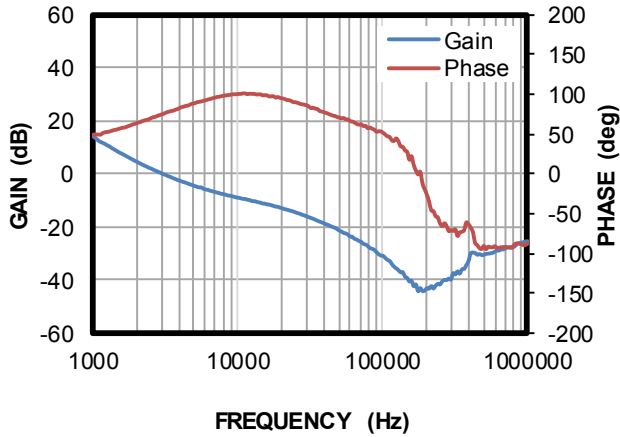

Bode Plot

V_{OUT} = 12V, I_{OUT} = 3A, BW = 2.64kHz,
PM = 75deg

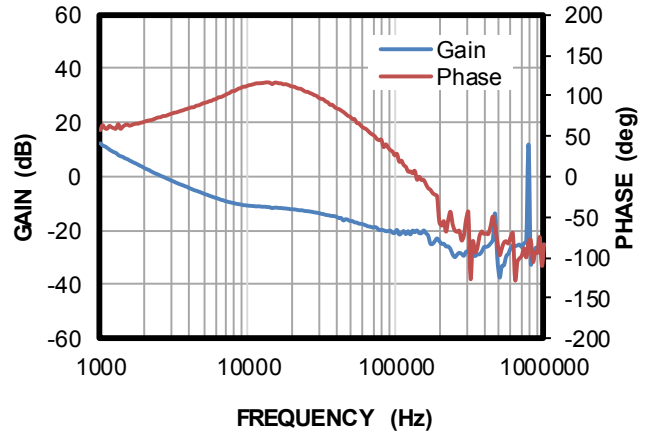

Bode Plot

V_{OUT} = 20V, I_{OUT} = 3A, BW = 2.3kHz,
PM = 64.48deg

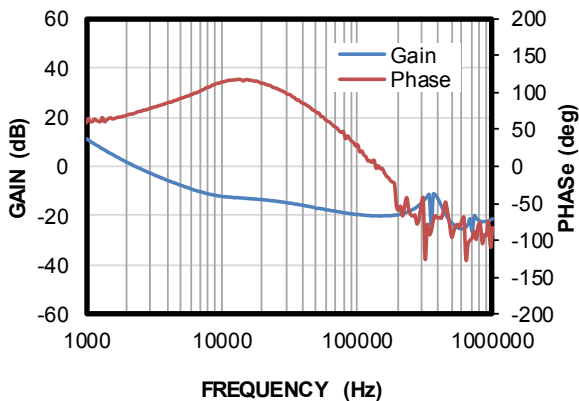

Thermal Rise

V_{IN} = 12V, V_{OUT} = 5V, f_{sw} = 400kHz,
based on EVQ4210-U-00B

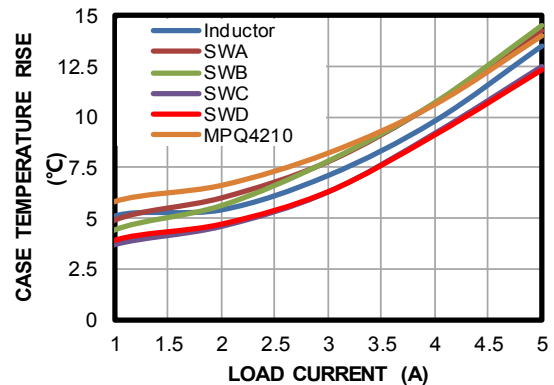

Thermal Rise

V_{IN} = 12V, V_{OUT} = 9V, f_{sw} = 400kHz,
based on EVQ4210-U-00B

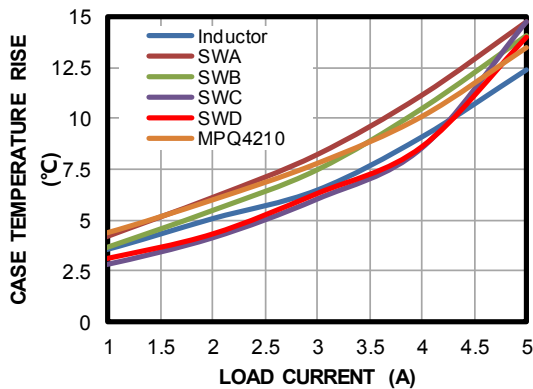

Thermal Rise

V_{IN} = 12V, V_{OUT} = 15V, f_{sw} = 400kHz,
based on EVQ4210-U-00B

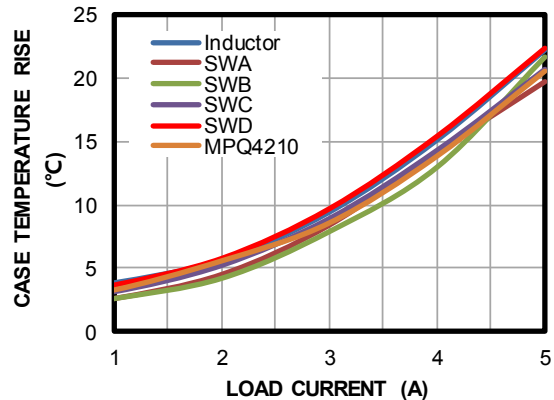

EVB TEST RESULTS *(continued)*

Performance curves and waveforms are tested on the evaluation board.

V_{IN} = 12V, V_{OUT} = 5V, L = 4.7μH, T_A = +25°C, unless otherwise noted.

Thermal Rise

V_{IN} = 12V, V_{OUT} = 20V, f_{SW} = 400kHz,
based on EVQ4210-U-00B

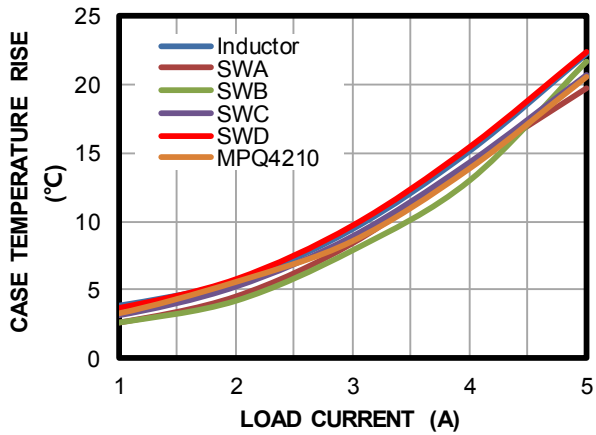

EVB TEST RESULTS (CONTINUED)

Performance curves and waveforms are tested on the evaluation board.

$V_{IN} = 12V$, $V_{OUT} = 5V$, $L = 4.7\mu H$, $T_A = +25^\circ C$, unless otherwise noted.

ENPWR Bit Enable through I2C Command , Load=0A

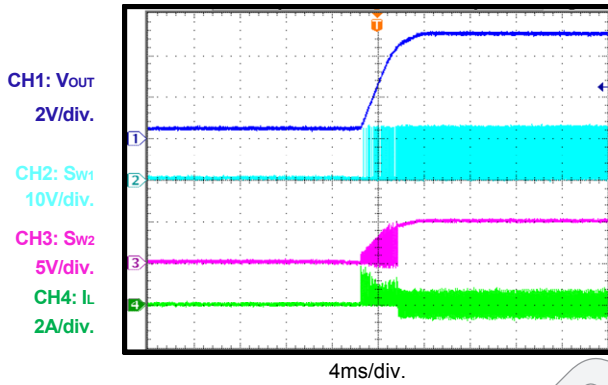

ENPWR Bit Enable through I2C Command , Load=5A

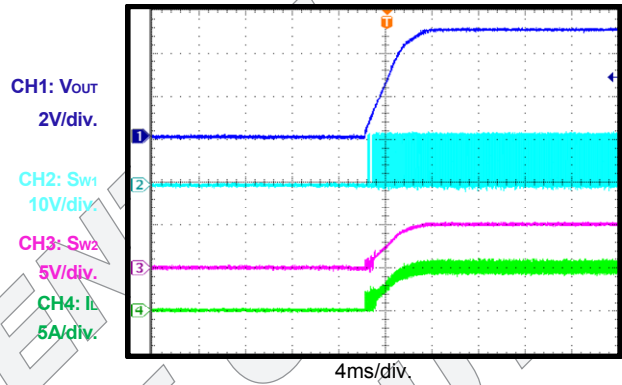

ENPWR Bit Disable through I2C Command , Load=0A

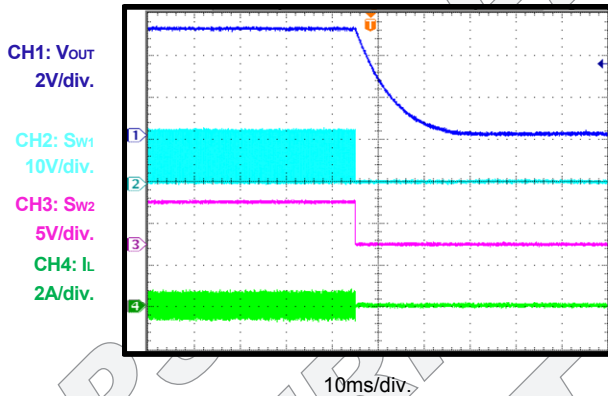

ENPWR Bit Disable through I2C Command , Load=5A

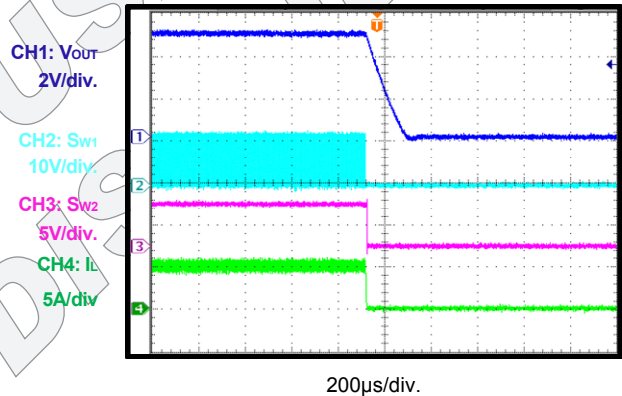

EN Pin Disable , Load=10mA

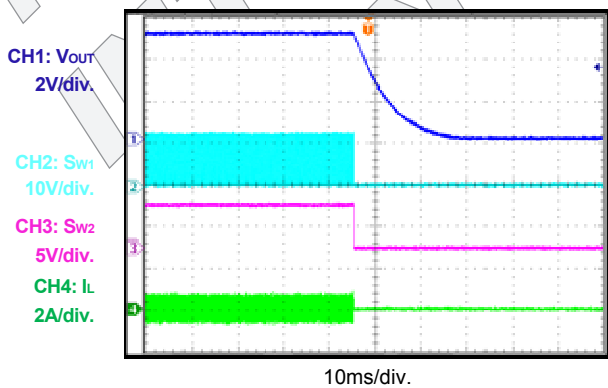

EN Pin Disable , Load=5A

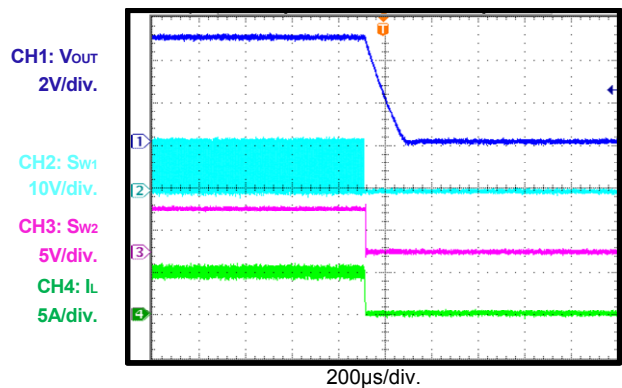

EVB TEST RESULTS (continued)

Performance curves and waveforms are tested on the evaluation board.

 $V_{IN} = 12V$, $V_{OUT} = 5V$, $L = 4.7\mu H$, $T_A = +25^\circ C$, unless otherwise noted.

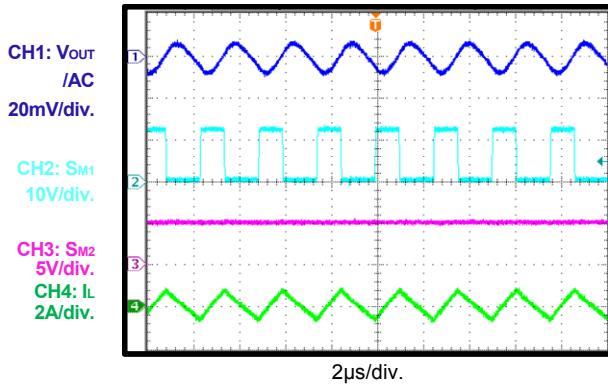
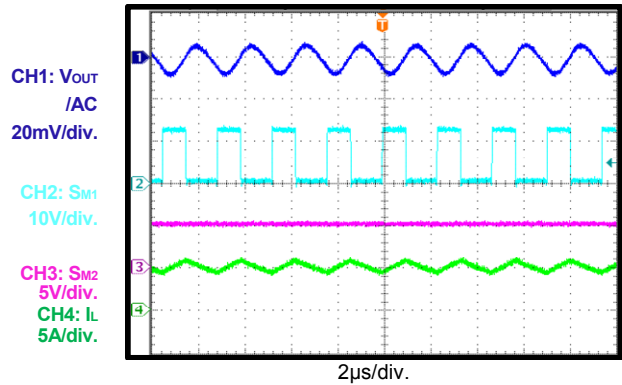
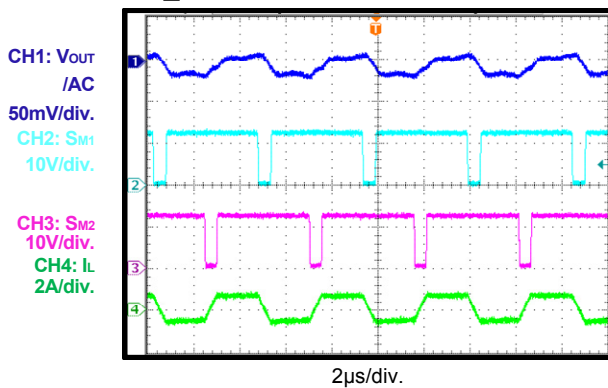
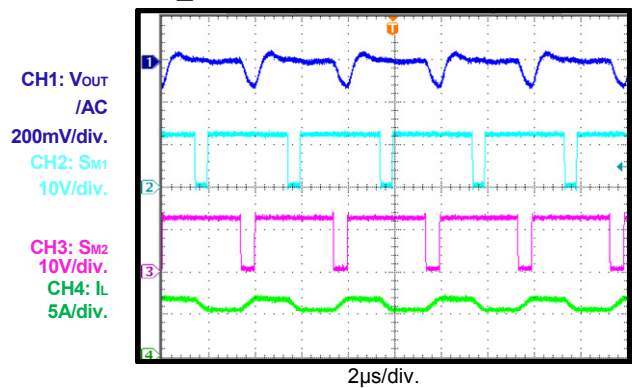
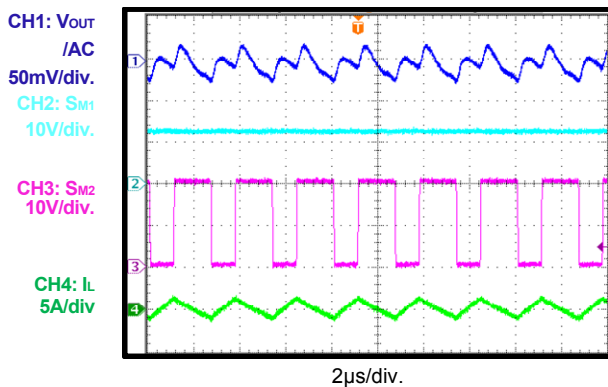
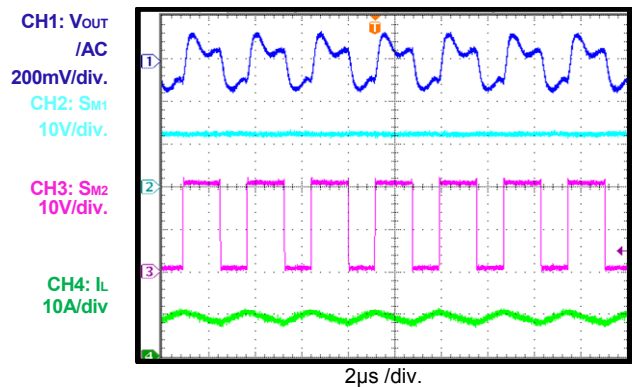
Steady state , $V_{OUT}=5V$ Load=0A

Steady state $V_{OUT}=5V$ Load=5A

**Steady state , $V_{OUT}=12V$,
BB_FSW=1 , Load=0A**

**Steady state , $V_{OUT}=12V$,
BB_FSW=1 , Load=5A**

Steady state , $V_{OUT}=20V$, Load=0A

Steady state , $V_{OUT}=20V$ Load=5A

EVB TEST RESULTS (continued)

Performance curves and waveforms are tested on the evaluation board.

V_{IN} = 12V, V_{OUT} = 5V, L = 4.7μH, T_A = +25°C, unless otherwise noted.

Load Transient

V_{IN}=12V, V_{OUT}=5V, Load=0A to 2.5A, 150mA/us

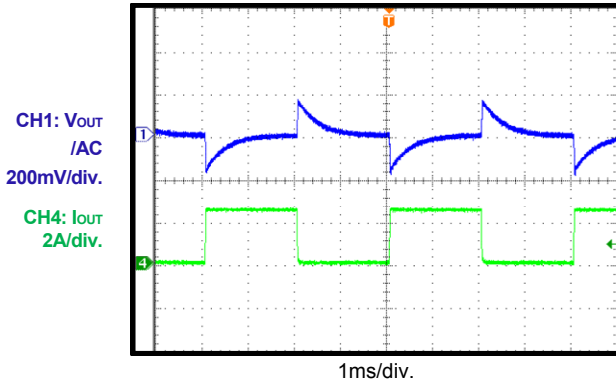

V_{IN}=12V, V_{OUT}=5V, Load=2.5A to 5A, 150mA/us

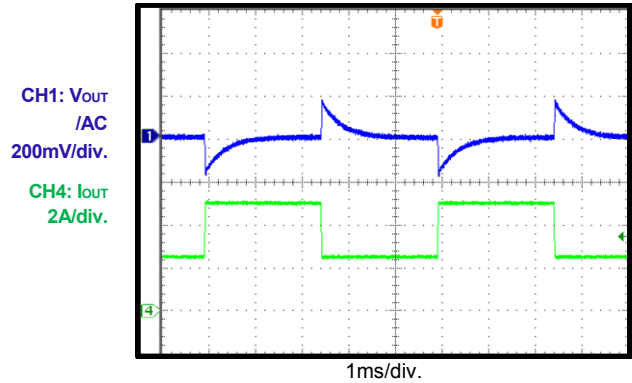

V_{IN}=12V, V_{OUT}=20V, Load=0A to 2.5A, 150mA/us

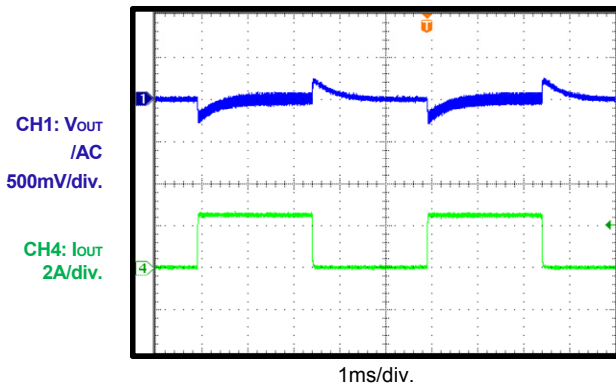

V_{IN}=12V, V_{OUT}=20V, Load=2.5A to 5A, 150mA/us

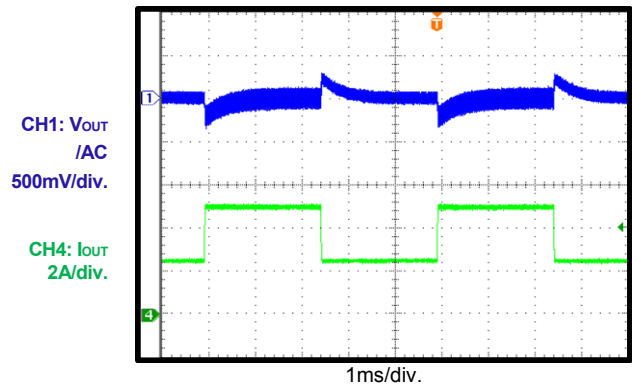

Input Voltage Transient,

V_{IN}=9V to 20V, V_{OUT}=15V, Load=0A

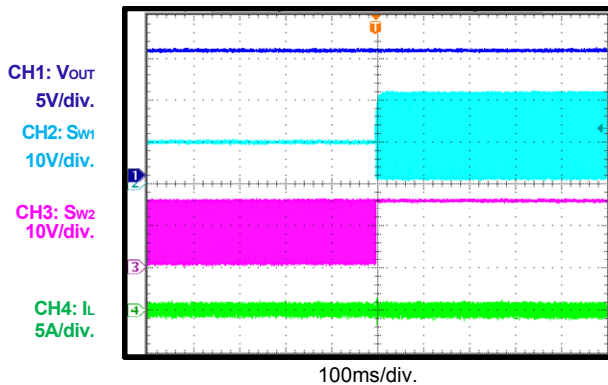

Input Voltage Transient,

V_{IN}=9V to 20V, V_{OUT}=15V, Load=5A

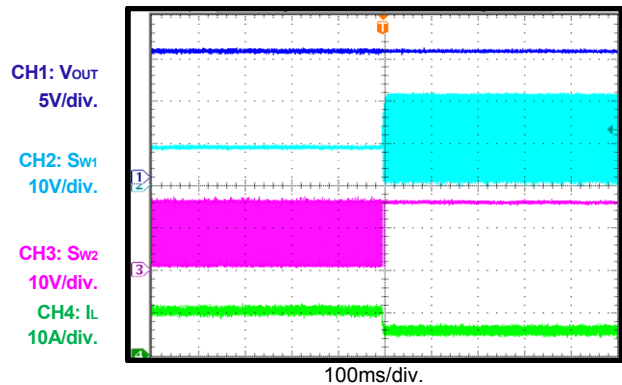

EVB TEST RESULTS (continued)

Performance curves and waveforms are tested on the evaluation board.

V_{IN} = 12V, V_{OUT} = 5V, L = 4.7μH, T_A = +25°C, unless otherwise noted.

Input Voltage Transient,
V_{IN}=20V to 9V, V_{OUT}=15V, Load=0A

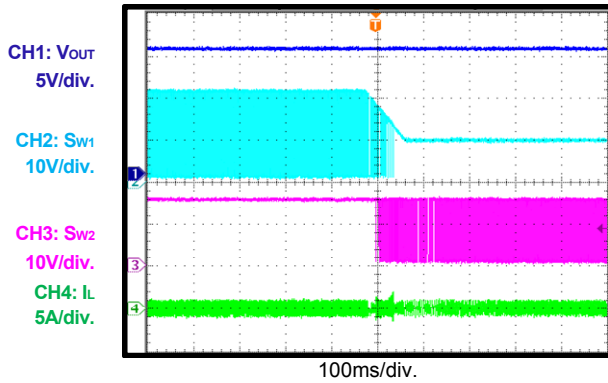

Input Voltage Transient,
V_{IN}=20V to 9V, V_{OUT}=15V, Load=5A

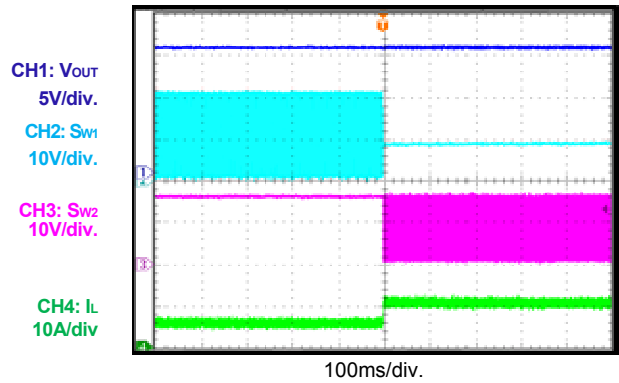

Output Voltage Transient,
V_{OUT}=5V to 12V, I_{OUT}=5A

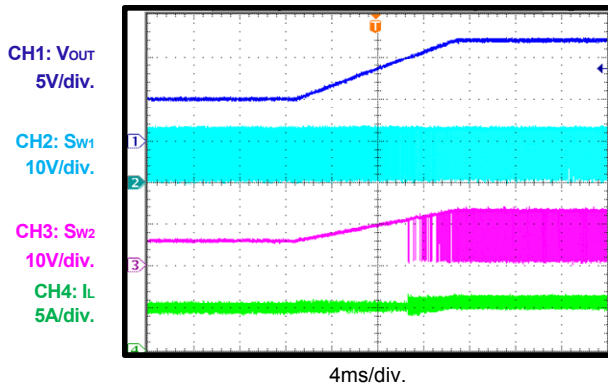

Output Voltage Transient,
V_{OUT}=12V to 5V, Load=5A

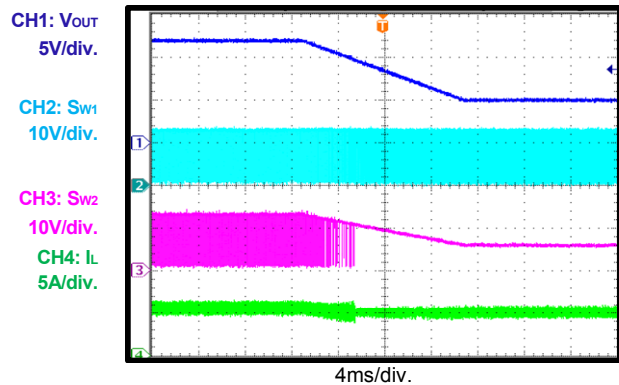

Output Voltage Transient,
V_{OUT}=5V to 20V, Load=5A

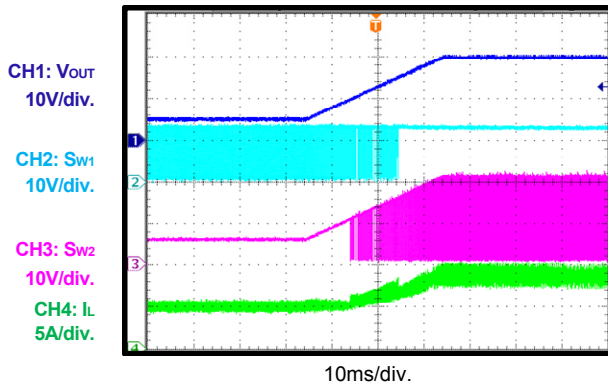

Output Voltage Transient,
V_{OUT}=20V to 5V, Load=5A

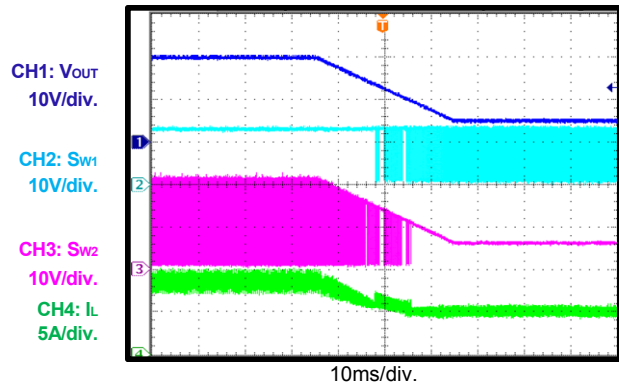

EVB TEST RESULTS (continued)

Performance curves and waveforms are tested on the evaluation board.

 $V_{IN} = 12V$, $V_{OUT} = 5V$, $L = 4.7\mu H$, $T_A = +25^{\circ}C$, unless otherwise noted.

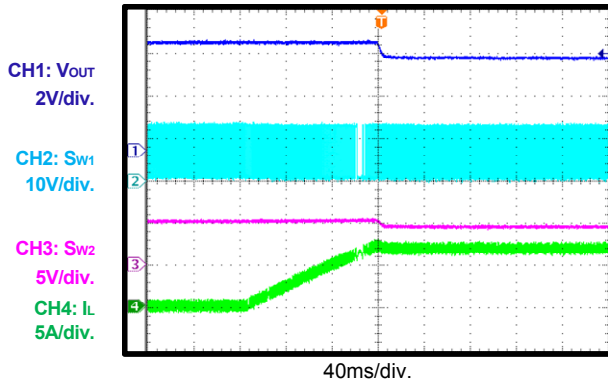
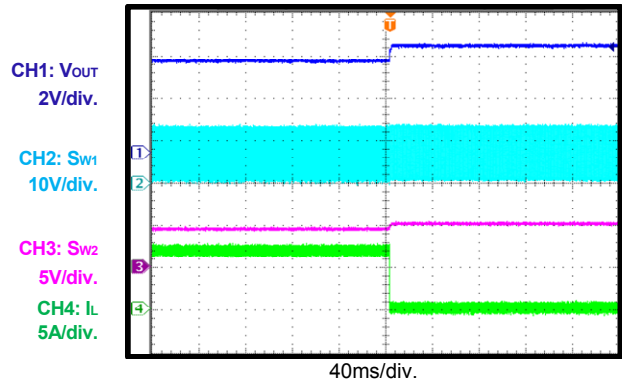
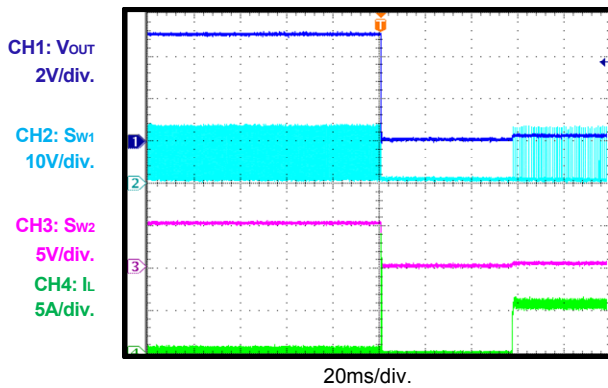
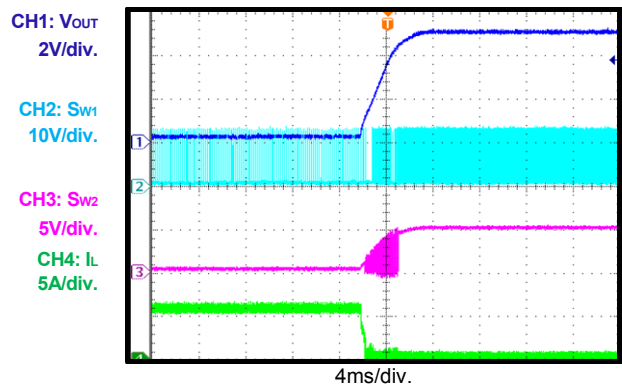
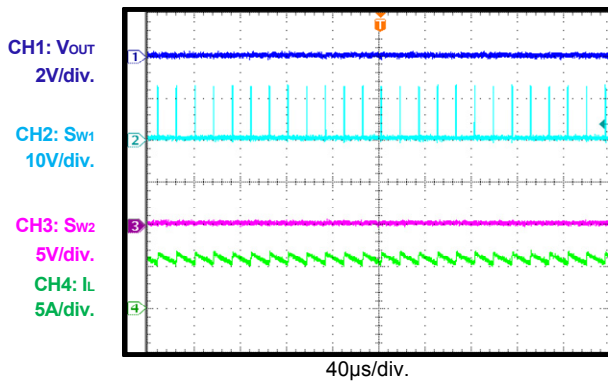
OCP Enter

OCP recover

SCP enter

SCP recover

SCP steady state

PRINTED CIRCUIT BOARD LAYOUT

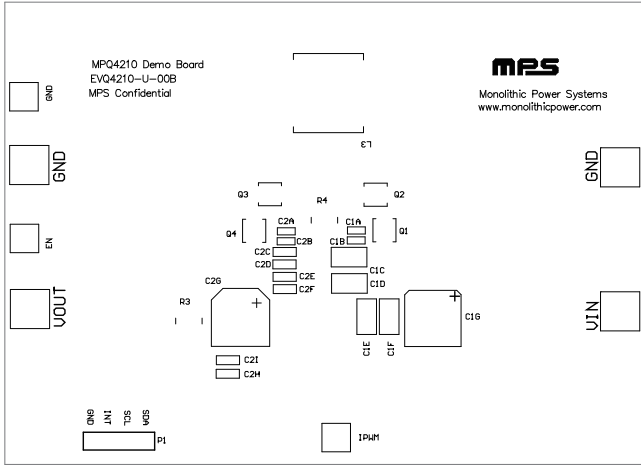

Figure 1: Top Silkscreen Layer

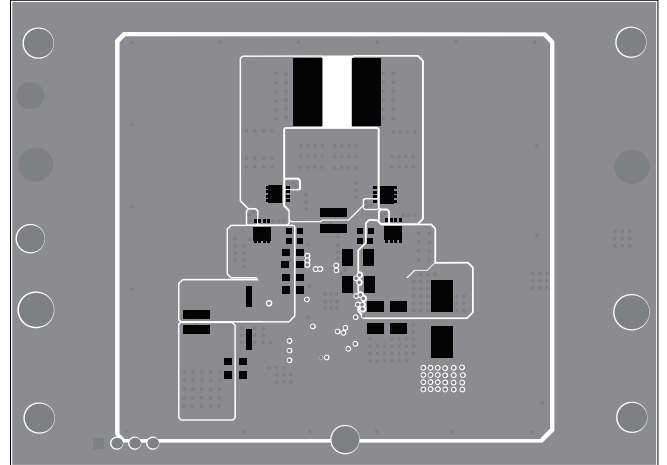

Figure 2: Top Layer

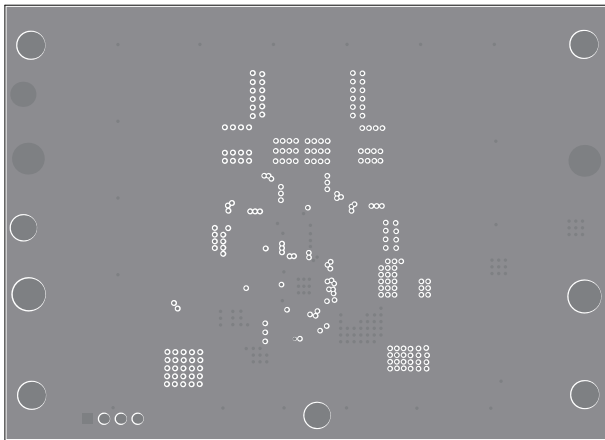

Figure 3: Middle Layer 1

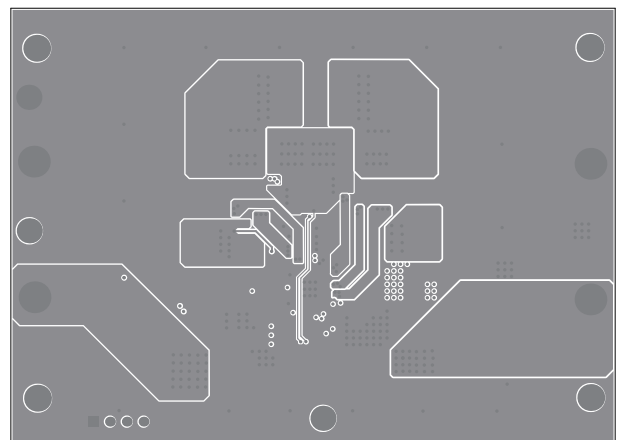

Figure 4: Middle Layer 2

QUICK START GUIDE

1. Connect the positive and negative terminals of the load($\leq 3A$) to the VOUT and GND pins, respectively.
2. Preset the power supply output voltage within the range 6V~40V, and then turn off the power supply.
3. Connect the positive and negative terminals of the power supply output to the VIN and GND pins, respectively.
4. Install the MPQ4210 GUI software, connect I²C cable from host computer to the board. (MPS provides USB to IC develop dongle for MPQ4210 GUI control)
5. Turn on the power supply. And then click Detect button on the GUI.
6. Normally the GUI will indicate the connection is OK.

Then set MPQ4210 registers through I²C in following step:

- a. Set ILIM bits to 111b for >5A load current limit;
- b. Set 0x02h bit[2] to 1b before ENPWR=1;
- c. Set BB_FSW bit to 1b to get higher frequency in buck-boost mode.
- d. Set ENPWR=1 to enable MPQ4210 switching, default output voltage is 5V.
- e. If other output voltage is required, firstly set the REF bits ($V_{out}=10 \cdot V_{REF}$), then write GO_BIT=1, MPQ4210 will change V_{OUT} automatically.

NOTICE: The information in this document is subject to change without notice. Please contact MPS for current specifications. Users should warrant and guarantee that third party Intellectual Property rights are not infringed upon when integrating MPS products into any application. MPS will not assume any legal responsibility for any said applications.