

# NCV8716

## Low Dropout Regulator - Ultra-Low Iq, Wide Input Voltage

### 80 mA

The NCV8716 is 80 mA LDO Linear Voltage Regulator. It is a very stable and accurate device with ultra-low ground current consumption (4.7  $\mu\text{A}$  over the full output load range) and a wide input voltage range (up to 24 V). The regulator incorporates several protection features such as Thermal Shutdown and Current Limiting.

#### Features

- Operating Input Voltage Range: 2.5 V to 24 V
- Fixed Voltage Options Available:  
1.5 V to 5.0 V
- Ultra Low Quiescent Current: Max. 5.8  $\mu\text{A}$  over Temperature
- $\pm 2\%$  Accuracy over Full Load, Line and Temperature Variations
- PSRR: 60 dB at 100 kHz
- Noise: 200  $\mu\text{V}_{\text{RMS}}$  from 200 Hz to 100 kHz
- Thermal Shutdown and Current Limit Protection
- Available in wDFN6, 2x2x0.8 mm Package
- NCV Prefix for Automotive and Other Applications Requiring Unique Site and Control Change Requirements; AEC-Q100 Qualified and PPAP Capable; Device Temperature Grade 1:  $-40^{\circ}\text{C}$  to  $+125^{\circ}\text{C}$  Ambient Operating Temperature Range
- These Devices are Pb-Free, Halogen Free/BFR Free and are RoHS Compliant

#### Typical Applications

- Portable Equipment
- Communication Systems

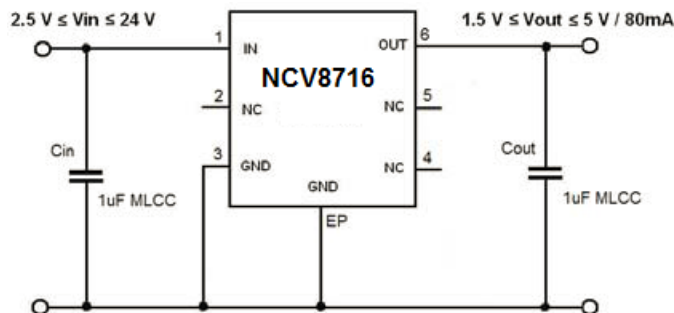

Figure 1. Typical Application Schematic



ON Semiconductor®

[www.onsemi.com](http://www.onsemi.com)



WDFN6  
CASE 511BR

#### MARKING DIAGRAMS

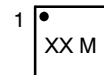

XX = Specific Device Code  
M = Date Code

#### PIN CONNECTIONS

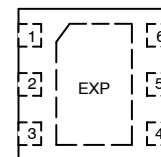

WDFN6 2x2 mm  
(Top View)

#### ORDERING INFORMATION

See detailed ordering, marking and shipping information on page 17 of this data sheet.

# NCV8716

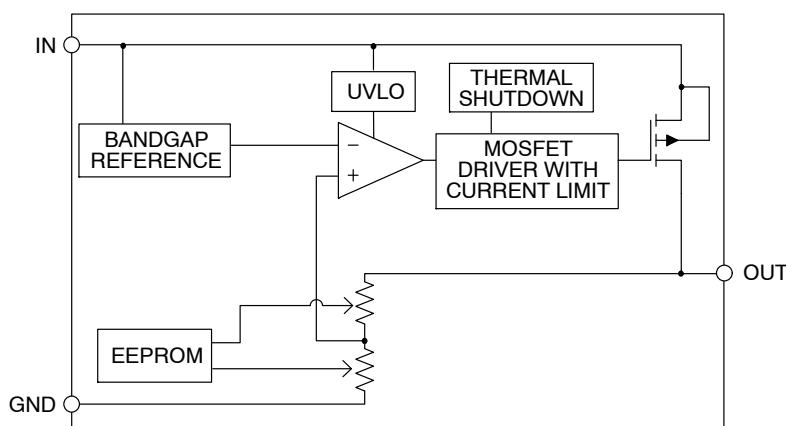

**Figure 2. Simplified Block Diagram**

**Table 1. PIN FUNCTION DESCRIPTION**

Pin No.	Pin Name	Description
6	OUT	Regulated output voltage pin. A small 0.47 $\mu\text{F}$ ceramic capacitor is needed from this pin to ground to assure stability.
2	N/C	No connection. This pin can be tied to ground to improve thermal dissipation or left disconnected.
3, EXP	GND	Power supply ground. Exposed pad EXP must be tied with GND pin 3.
4	N/C	No connection. This pin can be tied to ground to improve thermal dissipation or left disconnected.
5	N/C	No connection. This pin can be tied to ground to improve thermal dissipation or left disconnected.
1	IN	Input pin. A small capacitor is needed from this pin to ground to assure stability.

**Table 2. ABSOLUTE MAXIMUM RATINGS**

Rating	Symbol	Value	Unit
Input Voltage (Note 1)	$V_{IN}$	-0.3 to 24	V
Output Voltage	$V_{OUT}$	-0.3 to 6	V
Output Short Circuit Duration	$t_{SC}$	Indefinite	s
Maximum Junction Temperature	$T_{J(MAX)}$	150	$^{\circ}\text{C}$
Operating Ambient Temperature Range	$T_A$	-40 to 125	$^{\circ}\text{C}$
Storage Temperature Range	$T_{STG}$	-55 to 150	$^{\circ}\text{C}$
ESD Capability, Human Body Model (Note 2)	$ESD_{HBM}$	2000	V
ESD Capability, Machine Model (Note 2)	$ESD_{MM}$	200	V

Stresses exceeding Maximum Ratings may damage the device. Maximum Ratings are stress ratings only. Functional operation above the Recommended Operating Conditions is not implied. Extended exposure to stresses above the Recommended Operating Conditions may affect device reliability.

- Refer to ELECTRICAL CHARACTERISTICS and APPLICATION INFORMATION for Safe Operating Area.
- This device series incorporates ESD protection and is tested by the following methods:  
 ESD Human Body Model tested per EIA/JESD22-A114  
 ESD Machine Model tested per EIA/JESD22-A115  
 Latch up Current Maximum Rating tested per JEDEC standard: JESD78.

**Table 3. THERMAL CHARACTERISTICS**

Rating	Symbol	Value	Unit
Thermal Characteristics, wDFN6, 2 mm x 2 mm Thermal Resistance, Junction-to-Air	$R_{\theta JA}$	120	$^{\circ}\text{C}/\text{W}$

**Table 4. RECOMMENDED OPERATING CONDITIONS**

Parameter	Symbol	Min	Max	Unit
Input Voltage	$V_{IN}$	2.5	24	V
Junction Temperature	$T_J$	-40	125	$^{\circ}\text{C}$

Functional operation above the stresses listed in the Recommended Operating Ranges is not implied. Extended exposure to stresses beyond the Recommended Operating Ranges limits may affect device reliability.

# NCV8716

**Table 5. ELECTRICAL CHARACTERISTICS Voltage version 1.5 V**

$-40^{\circ}\text{C} \leq T_J \leq 125^{\circ}\text{C}$ ;  $V_{IN} = 3.0\text{ V}$ ;  $I_{OUT} = 1\text{ mA}$ ,  $C_{IN} = C_{OUT} = 1.0\text{ }\mu\text{F}$ , unless otherwise noted. Typical values are at  $T_J = +25^{\circ}\text{C}$ . (Note 5)

Parameter	Test Conditions	Symbol	Min	Typ	Max	Unit
Operating Input Voltage	$I_{OUT} \leq 10\text{ mA}$	$V_{IN}$	2.5		24	V
	$10\text{ mA} < I_{OUT} < 80\text{ mA}$		3.0		24	
Output Voltage Accuracy	$3.0\text{ V} < V_{IN} < 24\text{ V}$ , $0 < I_{OUT} < 80\text{ mA}$	$V_{OUT}$	1.455	1.5	1.545	V
Line Regulation	$3.0\text{ V} \leq V_{IN} \leq 24\text{ V}$ , $I_{OUT} = 1\text{ mA}$	Reg <sub>LINE</sub>		20	25	mV
Load Regulation	$I_{OUT} = 0\text{ mA}$ to $80\text{ mA}$	Reg <sub>LOAD</sub>		20	25	mV
Dropout voltage (Note 3)						
Maximum Output Current	(Note 6)	$I_{OUT}$	110			mA
Ground current	$0 < I_{OUT} < 80\text{ mA}$ , $V_{IN} = 24\text{ V}$	$I_{GND}$		3.4	5.8	$\mu\text{A}$
Power Supply Rejection Ratio	$V_{IN} = 3.0\text{ V}$ , $V_{OUT} = 1.5\text{ V}$ $V_{PP} = 200\text{ mV}$ modulation $I_{OUT} = 1\text{ mA}$ , $C_{OUT} = 10\text{ }\mu\text{F}$	$f = 100\text{ kHz}$ PSRR		56		dB
Output Noise Voltage	$V_{OUT} = 1.5\text{ V}$ , $I_{OUT} = 80\text{ mA}$ $f = 200\text{ Hz}$ to $100\text{ kHz}$	$V_N$		120		$\mu\text{V}_{rms}$
Thermal Shutdown Temperature (Note 4)	Temperature increasing from $T_J = +25^{\circ}\text{C}$	$T_{SD}$		155		$^{\circ}\text{C}$
Thermal Shutdown Hysteresis (Note 4)	Temperature falling from $T_{SD}$	$T_{SDH}$	-	25	-	$^{\circ}\text{C}$

Product parametric performance is indicated in the Electrical Characteristics for the listed test conditions, unless otherwise noted. Product performance may not be indicated by the Electrical Characteristics if operated under different conditions.

3. Not Characterized at  $V_{IN} = 3.0\text{ V}$ ,  $V_{OUT} = 1.5\text{ V}$ ,  $I_{OUT} = 80\text{ mA}$

4. Guaranteed by design and characterization.

5. Performance guaranteed over the indicated operating temperature range by design and/or characterization production tested at

$T_J = T_A = 25^{\circ}\text{C}$ . Low duty cycle pulse techniques are used during testing to maintain the junction temperature as close to ambient as possible.

6. Respect SOA

# NCV8716

**Table 6. ELECTRICAL CHARACTERISTICS Voltage version 1.8 V**

$-40^{\circ}\text{C} \leq T_J \leq 125^{\circ}\text{C}$ ;  $V_{IN} = 3.0\text{ V}$ ;  $I_{OUT} = 1\text{ mA}$ ,  $C_{IN} = C_{OUT} = 1.0\text{ }\mu\text{F}$ , unless otherwise noted. Typical values are at  $T_J = +25^{\circ}\text{C}$ . (Note 9)

Parameter	Test Conditions	Symbol	Min	Typ	Max	Unit
Operating Input Voltage	$I_{OUT} \leq 10\text{ mA}$	$V_{IN}$	2.8		24	V
	$10\text{ mA} < I_{OUT} < 80\text{ mA}$		3.0		24	
Output Voltage Accuracy	$3.0\text{ V} < V_{IN} < 24\text{ V}$ , $0 < I_{OUT} < 80\text{ mA}$	$V_{OUT}$	1.746	1.8	1.854	V
Line Regulation	$3.0\text{ V} \leq V_{IN} \leq 24\text{ V}$ , $I_{OUT} = 1\text{ mA}$	$\text{Reg}_{LINE}$		15	20	mV
Load Regulation	$I_{OUT} = 0\text{ mA}$ to $80\text{ mA}$	$\text{Reg}_{LOAD}$		15	20	mV
Dropout voltage (Note 7)						
Maximum Output Current	(Note 10)	$I_{OUT}$	110			mA
Ground current	$0 < I_{OUT} < 80\text{ mA}$ , $V_{IN} = 24\text{ V}$	$I_{GND}$		3.4	5.8	$\mu\text{A}$
Power Supply Rejection Ratio	$V_{IN} = 3.0\text{ V}$ , $V_{OUT} = 1.8\text{ V}$ $V_{PP} = 200\text{ mV}$ modulation $I_{OUT} = 1\text{ mA}$ , $C_{OUT} = 10\text{ }\mu\text{F}$	$f = 100\text{ kHz}$ $\text{PSRR}$		60		dB
Output Noise Voltage	$V_{OUT} = 1.8\text{ V}$ , $I_{OUT} = 80\text{ mA}$ $f = 200\text{ Hz}$ to $100\text{ kHz}$	$V_N$		140		$\mu\text{V}_{rms}$
Thermal Shutdown Temperature (Note 8)	Temperature increasing from $T_J = +25^{\circ}\text{C}$	$T_{SD}$		155		$^{\circ}\text{C}$
Thermal Shutdown Hysteresis (Note 8)	Temperature falling from $T_{SD}$	$T_{SDH}$	-	25	-	$^{\circ}\text{C}$

Product parametric performance is indicated in the Electrical Characteristics for the listed test conditions, unless otherwise noted. Product performance may not be indicated by the Electrical Characteristics if operated under different conditions.

7. Not Characterized at  $V_{IN} = 3.0\text{ V}$ ,  $V_{OUT} = 1.8\text{ V}$ ,  $I_{OUT} = 80\text{ mA}$

8. Guaranteed by design and characterization.

9. Performance guaranteed over the indicated operating temperature range by design and/or characterization production tested at  $T_J = T_A = 25^{\circ}\text{C}$ . Low duty cycle pulse techniques are used during testing to maintain the junction temperature as close to ambient as possible.

10. Respect SOA

# NCV8716

**Table 7. ELECTRICAL CHARACTERISTICS Voltage version 2.5 V**

$-40^{\circ}\text{C} \leq T_J \leq 125^{\circ}\text{C}$ ;  $V_{IN} = 3.5\text{ V}$ ;  $I_{OUT} = 1\text{ mA}$ ,  $C_{IN} = C_{OUT} = 1.0\text{ }\mu\text{F}$ , unless otherwise noted. Typical values are at  $T_J = +25^{\circ}\text{C}$ . (Note 13)

Parameter	Test Conditions	Symbol	Min	Typ	Max	Unit
Operating Input Voltage	$I_{OUT} = 80\text{ mA}$	$V_{IN}$	3.5		24	V
Output Voltage Accuracy	$3.5\text{ V} < V_{IN} < 24\text{ V}$ , $0 < I_{OUT} < 80\text{ mA}$	$V_{OUT}$	2.45	2.5	2.55	V
Line Regulation	$V_{OUT} + 1\text{ V} \leq V_{IN} \leq 24\text{ V}$ , $I_{OUT} = 1\text{ mA}$	Reg <sub>LINE</sub>		15	20	mV
Load Regulation	$I_{OUT} = 0\text{ mA to } 80\text{ mA}$	Reg <sub>LOAD</sub>		15	20	mV
Dropout voltage (Note 11)	$V_{DO} = V_{IN} - (V_{OUT(NOM)} - 125\text{ mV})$ $I_{OUT} = 80\text{ mA}$	$V_{DO}$		400	640	mV
Maximum Output Current	(Note 14)	$I_{OUT}$	110			mA
Ground current	$0 < I_{OUT} < 80\text{ mA}$ , $V_{IN} = 24\text{ V}$	$I_{GND}$		3.4	5.8	$\mu\text{A}$
Power Supply Rejection Ratio	$V_{IN} = 3.5\text{ V}$ , $V_{OUT} = 2.5\text{ V}$ $V_{PP} = 200\text{ mV}$ modulation $I_{OUT} = 1\text{ mA}$ , $C_{OUT} = 10\text{ }\mu\text{F}$ $f = 100\text{ kHz}$	PSRR		60		dB
Output Noise Voltage	$V_{OUT} = 2.5\text{ V}$ , $I_{OUT} = 80\text{ mA}$ $f = 200\text{ Hz to } 100\text{ kHz}$	$V_N$		160		$\mu\text{V}_{rms}$
Thermal Shutdown Temperature (Note 12)	Temperature increasing from $T_J = +25^{\circ}\text{C}$	$T_{SD}$		155		$^{\circ}\text{C}$
Thermal Shutdown Hysteresis (Note 12)	Temperature falling from $T_{SD}$	$T_{SDH}$	-	25	-	$^{\circ}\text{C}$

Product parametric performance is indicated in the Electrical Characteristics for the listed test conditions, unless otherwise noted. Product performance may not be indicated by the Electrical Characteristics if operated under different conditions.

11. Characterized when  $V_{OUT}$  falls 125 mV below the regulated voltage and only for devices with  $V_{OUT} = 2.5\text{ V}$

12. Guaranteed by design and characterization.

13. Performance guaranteed over the indicated operating temperature range by design and/or characterization production tested at  $T_J = T_A = 25^{\circ}\text{C}$ . Low duty cycle pulse techniques are used during testing to maintain the junction temperature as close to ambient as possible.

14. Respect SOA

# NCV8716

**Table 8. ELECTRICAL CHARACTERISTICS Voltage version 2.8 V**

$-40^{\circ}\text{C} \leq T_J \leq 125^{\circ}\text{C}$ ;  $V_{IN} = 3.8\text{ V}$ ;  $I_{OUT} = 1\text{ mA}$ ,  $C_{IN} = C_{OUT} = 1.0\text{ }\mu\text{F}$ , unless otherwise noted. Typical values are at  $T_J = +25^{\circ}\text{C}$ . (Note 17)

Parameter	Test Conditions	Symbol	Min	Typ	Max	Unit
Operating Input Voltage	$I_{OUT} = 80\text{ mA}$	$V_{IN}$	3.8		24	V
Output Voltage Accuracy	$3.8\text{ V} < V_{IN} < 24\text{ V}$ , $0 < I_{OUT} < 80\text{ mA}$	$V_{OUT}$	2.744	2.8	2.856	V
Line Regulation	$V_{OUT} + 1\text{ V} \leq V_{IN} \leq 24\text{ V}$ , $I_{OUT} = 1\text{ mA}$	Reg <sub>LINE</sub>		4	10	mV
Load Regulation	$I_{OUT} = 0\text{ mA to } 80\text{ mA}$	Reg <sub>LOAD</sub>		10	30	mV
Dropout voltage (Note 15)	$V_{DO} = V_{IN} - (V_{OUT(NOM)} - 150\text{ mV})$ $I_{OUT} = 80\text{ mA}$	$V_{DO}$		380	600	mV
Maximum Output Current	(Note 18)	$I_{OUT}$	110			mA
Ground current	$0 < I_{OUT} < 80\text{ mA}$ , $V_{IN} = 24\text{ V}$	$I_{GND}$		3.4	5.8	$\mu\text{A}$
Power Supply Rejection Ratio	$V_{IN} = 3.8\text{ V}$ , $V_{OUT} = 2.8\text{ V}$ $V_{PP} = 200\text{ mV modulation}$ $I_{OUT} = 1\text{ mA}$ , $C_{OUT} = 10\text{ }\mu\text{F}$ $f = 100\text{ kHz}$	PSRR		58		dB
Output Noise Voltage	$V_{OUT} = 2.8\text{ V}$ , $I_{OUT} = 80\text{ mA}$ $f = 200\text{ Hz to } 100\text{ kHz}$	$V_N$		180		$\mu\text{V}_{rms}$
Thermal Shutdown Temperature (Note 16)	Temperature increasing from $T_J = +25^{\circ}\text{C}$	$T_{SD}$		155		$^{\circ}\text{C}$
Thermal Shutdown Hysteresis (Note 16)	Temperature falling from $T_{SD}$	$T_{SDH}$	-	25	-	$^{\circ}\text{C}$

Product parametric performance is indicated in the Electrical Characteristics for the listed test conditions, unless otherwise noted. Product performance may not be indicated by the Electrical Characteristics if operated under different conditions.

15. Characterized when  $V_{OUT}$  falls 140 mV below the regulated voltage and only for devices with  $V_{OUT} = 2.8\text{ V}$

16. Guaranteed by design and characterization.

17. Performance guaranteed over the indicated operating temperature range by design and/or characterization production tested at  $T_J = T_A = 25^{\circ}\text{C}$ . Low duty cycle pulse techniques are used during testing to maintain the junction temperature as close to ambient as possible.

18. Respect SOA

# NCV8716

**Table 9. ELECTRICAL CHARACTERISTICS Voltage version 3.0 V**

$-40^{\circ}\text{C} \leq T_J \leq 125^{\circ}\text{C}$ ;  $V_{IN} = 4.0\text{ V}$ ;  $I_{OUT} = 1\text{ mA}$ ,  $C_{IN} = C_{OUT} = 1.0\text{ }\mu\text{F}$ , unless otherwise noted. Typical values are at  $T_J = +25^{\circ}\text{C}$ . (Note 21)

Parameter	Test Conditions	Symbol	Min	Typ	Max	Unit
Operating Input Voltage	$I_{OUT} = 80\text{ mA}$	$V_{IN}$	4.0		24	V
Output Voltage Accuracy	$4.0\text{ V} < V_{IN} < 24\text{ V}$ , $0 < I_{OUT} < 80\text{ mA}$	$V_{OUT}$	2.94	3.0	3.06	V
Line Regulation	$V_{OUT} + 1\text{ V} \leq V_{IN} \leq 24\text{ V}$ , $I_{OUT} = 1\text{ mA}$	Reg <sub>LINE</sub>		4	10	mV
Load Regulation	$I_{OUT} = 0\text{ mA to } 80\text{ mA}$	Reg <sub>LOAD</sub>		10	30	mV
Dropout voltage (Note 19)	$V_{DO} = V_{IN} - (V_{OUT(NOM)} - 150\text{ mV})$ $I_{OUT} = 80\text{ mA}$	$V_{DO}$		370	580	mV
Maximum Output Current	(Note 22)	$I_{OUT}$	110			mA
Ground current	$0 < I_{OUT} < 80\text{ mA}$ , $V_{IN} = 24\text{ V}$	$I_{GND}$		3.4	5.8	$\mu\text{A}$
Power Supply Rejection Ratio	$V_{IN} = 4.0\text{ V}$ , $V_{OUT} = 3.0\text{ V}$ $V_{PP} = 200\text{ mV modulation}$ $I_{OUT} = 1\text{ mA}$ , $C_{OUT} = 10\text{ }\mu\text{F}$ $f = 100\text{ kHz}$	PSRR		58		dB
Output Noise Voltage	$V_{OUT} = 3.0\text{ V}$ , $I_{OUT} = 80\text{ mA}$ $f = 200\text{ Hz to } 100\text{ kHz}$	$V_N$		190		$\mu\text{V}_{rms}$
Thermal Shutdown Temperature (Note 20)	Temperature increasing from $T_J = +25^{\circ}\text{C}$	$T_{SD}$		155		$^{\circ}\text{C}$
Thermal Shutdown Hysteresis (Note 20)	Temperature falling from $T_{SD}$	$T_{SDH}$	-	25	-	$^{\circ}\text{C}$

Product parametric performance is indicated in the Electrical Characteristics for the listed test conditions, unless otherwise noted. Product performance may not be indicated by the Electrical Characteristics if operated under different conditions.

19. Characterized when  $V_{OUT}$  falls 150 mV below the regulated voltage and only for devices with  $V_{OUT} = 3.0\text{ V}$

20. Guaranteed by design and characterization.

21. Performance guaranteed over the indicated operating temperature range by design and/or characterization production tested at  $T_J = T_A = 25^{\circ}\text{C}$ . Low duty cycle pulse techniques are used during testing to maintain the junction temperature as close to ambient as possible.

22. Respect SOA

# NCV8716

**Table 10. ELECTRICAL CHARACTERISTICS Voltage version 3.3 V**

$-40^{\circ}\text{C} \leq T_J \leq 125^{\circ}\text{C}$ ;  $V_{IN} = 4.3\text{ V}$ ;  $I_{OUT} = 1\text{ mA}$ ,  $C_{IN} = C_{OUT} = 1.0\text{ }\mu\text{F}$ , unless otherwise noted. Typical values are at  $T_J = +25^{\circ}\text{C}$ . (Note 25)

Parameter	Test Conditions	Symbol	Min	Typ	Max	Unit
Operating Input Voltage	$I_{OUT} = 80\text{ mA}$	$V_{IN}$	4.3		24	V
Output Voltage Accuracy	$4.3\text{ V} < V_{IN} < 24\text{ V}$ , $0 < I_{OUT} < 80\text{ mA}$	$V_{OUT}$	3.234	3.3	3.366	V
Line Regulation	$V_{OUT} + 1\text{ V} \leq V_{IN} \leq 24\text{ V}$ , $I_{OUT} = 1\text{ mA}$	Reg <sub>LINE</sub>		4	10	mV
Load Regulation	$I_{OUT} = 0\text{ mA to } 80\text{ mA}$	Reg <sub>LOAD</sub>		10	30	mV
Dropout voltage (Note 23)	$V_{DO} = V_{IN} - (V_{OUT(NOM)} - 165\text{ mV})$ $I_{OUT} = 80\text{ mA}$	$V_{DO}$		350	560	mV
Maximum Output Current	(Note 26)	$I_{OUT}$	110			mA
Ground current	$0 < I_{OUT} < 80\text{ mA}$ , $V_{IN} = 24\text{ V}$	$I_{GND}$		3.4	5.8	$\mu\text{A}$
Power Supply Rejection Ratio	$V_{IN} = 4.3\text{ V}$ , $V_{OUT} = 3.3\text{ V}$ $V_{PP} = 200\text{ mV modulation}$ $I_{OUT} = 1\text{ mA}$ , $C_{OUT} = 10\text{ }\mu\text{F}$ $f = 100\text{ kHz}$	PSRR		60		dB
Output Noise Voltage	$V_{OUT} = 4.3\text{ V}$ , $I_{OUT} = 80\text{ mA}$ $f = 200\text{ Hz to } 100\text{ kHz}$	$V_N$		200		$\mu\text{V}_{rms}$
Thermal Shutdown Temperature (Note 24)	Temperature increasing from $T_J = +25^{\circ}\text{C}$	$T_{SD}$		155		$^{\circ}\text{C}$
Thermal Shutdown Hysteresis (Note 24)	Temperature falling from $T_{SD}$	$T_{SDH}$	-	25	-	$^{\circ}\text{C}$

Product parametric performance is indicated in the Electrical Characteristics for the listed test conditions, unless otherwise noted. Product performance may not be indicated by the Electrical Characteristics if operated under different conditions.

23. Characterized when  $V_{OUT}$  falls 165 mV below the regulated voltage and only for devices with  $V_{OUT} = 3.3\text{ V}$

24. Guaranteed by design and characterization.

25. Performance guaranteed over the indicated operating temperature range by design and/or characterization production tested at  $T_J = T_A = 25^{\circ}\text{C}$ . Low duty cycle pulse techniques are used during testing to maintain the junction temperature as close to ambient as possible.

26. Respect SOA

# NCV8716

**Table 11. ELECTRICAL CHARACTERISTICS Voltage version 5.0 V**

$-40^{\circ}\text{C} \leq T_J \leq 125^{\circ}\text{C}$ ;  $V_{IN} = 6.0\text{ V}$ ;  $I_{OUT} = 1\text{ mA}$ ,  $C_{IN} = C_{OUT} = 1.0\ \mu\text{F}$ , unless otherwise noted. Typical values are at  $T_J = +25^{\circ}\text{C}$ . (Note 29)

Parameter	Test Conditions	Symbol	Min	Typ	Max	Unit
Operating Input Voltage	$I_{OUT} = 80\text{ mA}$	$V_{IN}$	6.0		24	V
Output Voltage Accuracy	$6.0\text{ V} < V_{IN} < 24\text{ V}$ , $0 < I_{OUT} < 80\text{ mA}$	$V_{OUT}$	4.9	5.0	5.1	V
Line Regulation	$V_{OUT} + 1\text{ V} \leq V_{IN} \leq 24\text{ V}$ , $I_{OUT} = 1\text{ mA}$	Reg <sub>LINE</sub>		4	10	mV
Load Regulation	$I_{OUT} = 0\text{ mA}$ to $80\text{ mA}$	Reg <sub>LOAD</sub>		10	30	mV
Dropout voltage (Note 27)	$V_{DO} = V_{IN} - (V_{OUT(NOM)} - 250\text{ mV})$ $I_{OUT} = 80\text{ mA}$	$V_{DO}$		310	500	mV
Maximum Output Current	(Note 30)	$I_{OUT}$	110			mA
Ground current	$0 < I_{OUT} < 80\text{ mA}$ , $V_{IN} = 24\text{ V}$	$I_{GND}$		3.4	5.8	$\mu\text{A}$
Power Supply Rejection Ratio	$V_{IN} = 6.0\text{ V}$ , $V_{OUT} = 5.0\text{ V}$ $V_{PP} = 200\text{ mV}$ modulation $I_{OUT} = 1\text{ mA}$ , $C_{OUT} = 10\ \mu\text{F}$	$f = 100\text{ kHz}$ PSRR		54		dB
Output Noise Voltage	$V_{OUT} = 5.0\text{ V}$ , $I_{OUT} = 80\text{ mA}$ $f = 200\text{ Hz}$ to $100\text{ kHz}$	$V_N$		220		$\mu\text{V}_{rms}$
Thermal Shutdown Temperature (Note 28)	Temperature increasing from $T_J = +25^{\circ}\text{C}$	$T_{SD}$		155		$^{\circ}\text{C}$
Thermal Shutdown Hysteresis (Note 28)	Temperature falling from $T_{SD}$	$T_{SDH}$	-	25	-	$^{\circ}\text{C}$

Product parametric performance is indicated in the Electrical Characteristics for the listed test conditions, unless otherwise noted. Product performance may not be indicated by the Electrical Characteristics if operated under different conditions.

27. Characterized when  $V_{OUT}$  falls 250 mV below the regulated voltage and only for devices with  $V_{OUT} = 5.0\text{ V}$

28. Guaranteed by design and characterization.

29. Performance guaranteed over the indicated operating temperature range by design and/or characterization production tested at  $T_J = T_A = 25^{\circ}\text{C}$ . Low duty cycle pulse techniques are used during testing to maintain the junction temperature as close to ambient as possible.

30. Respect SOA

TYPICAL CHARACTERISTICS

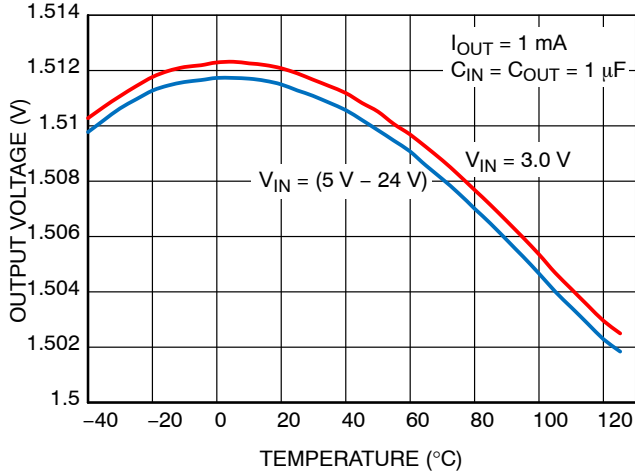

Figure 3. NCV8716x15xxx Output Voltage vs. Temperature

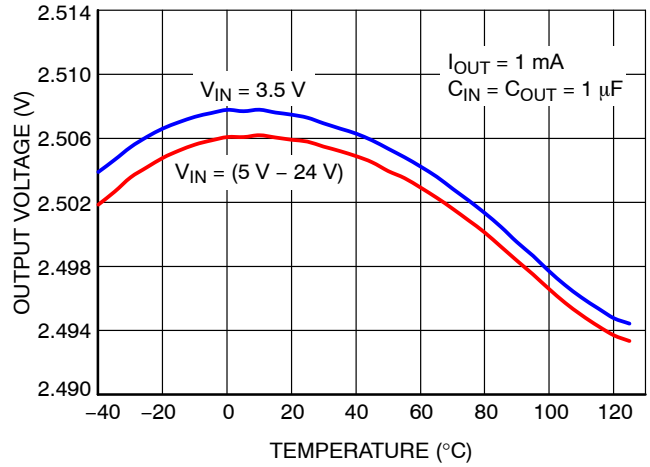

Figure 4. NCV8716x25xxx Output Voltage vs. Temperature

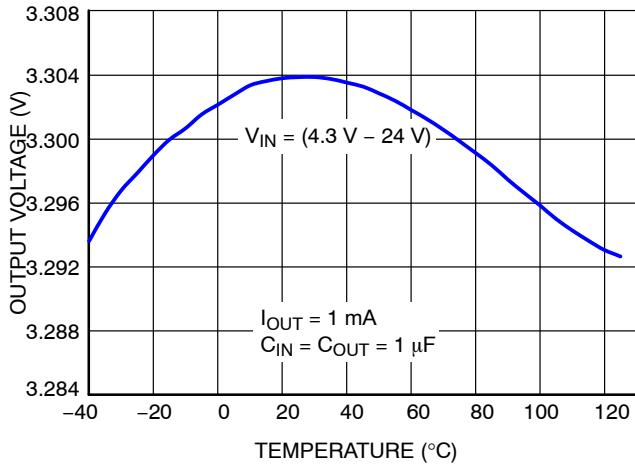

Figure 5. NCV8716x33xxx Output Voltage vs. Temperature

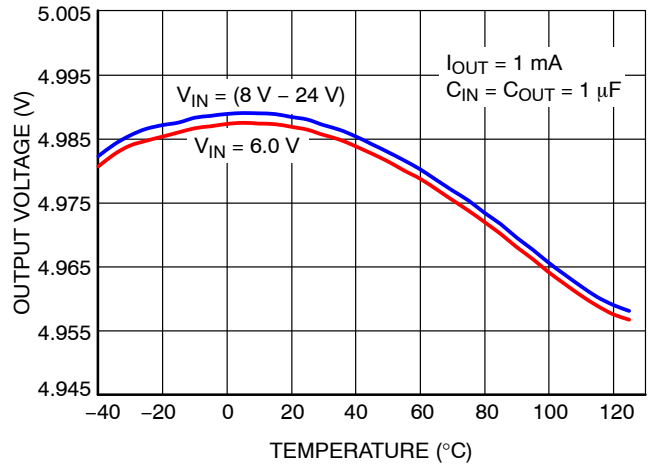

Figure 6. NCV8716x50xxx Output Voltage vs. Temperature

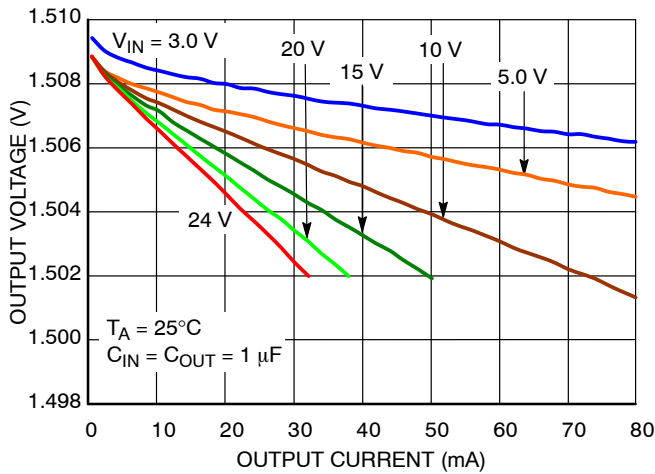

Figure 7. NCV8716x15xxx Output Voltage vs. Output Current

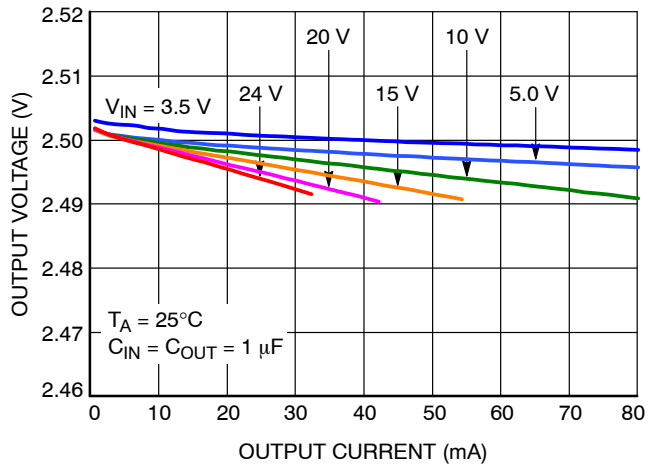

Figure 8. NCV8716x25xxx Output Voltage vs. Output Current

TYPICAL CHARACTERISTICS

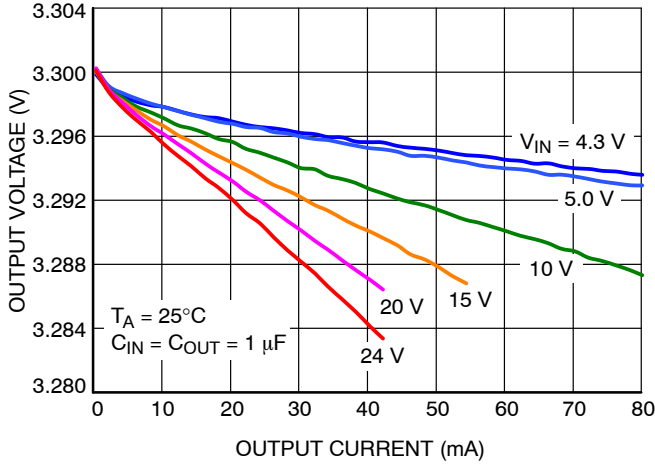

Figure 9. NCV8716x33xxx Output Voltage vs. Output Current

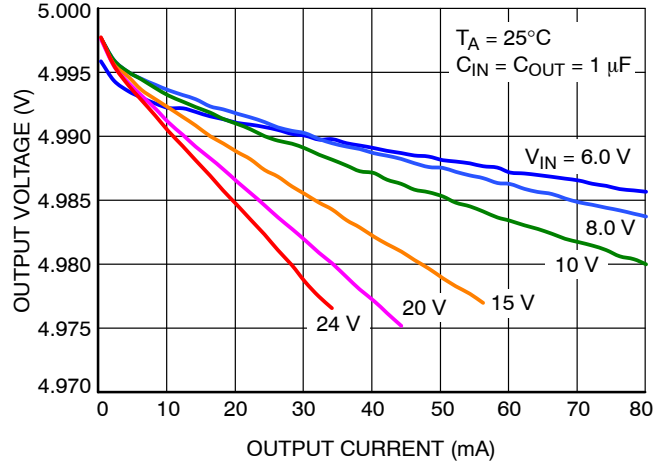

Figure 10. NCV8716x50xxx Output Voltage vs. Output Current

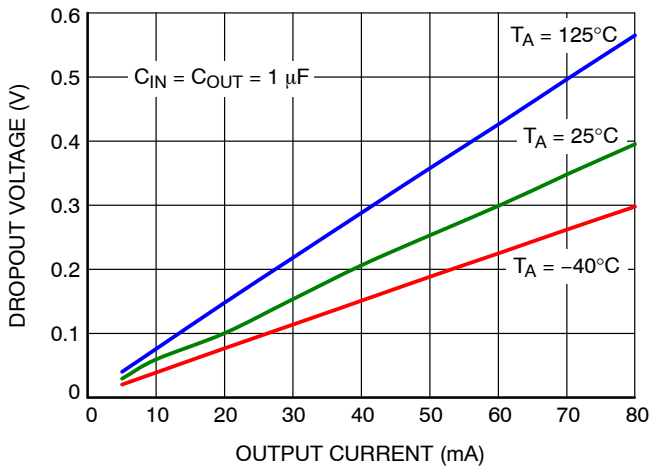

Figure 11. NCV8716x25xxx Dropout Voltage vs. Output Current

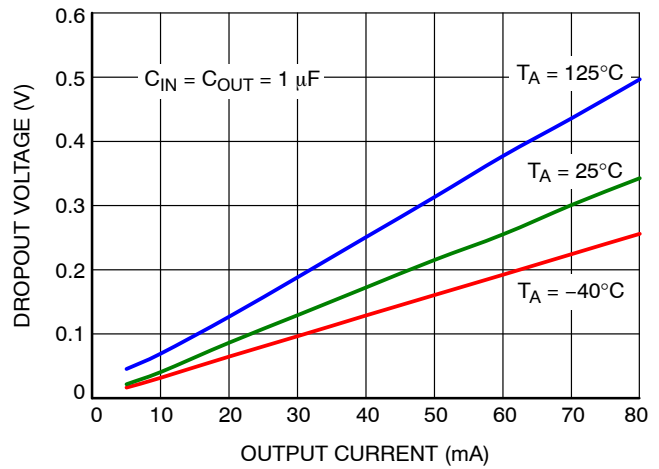

Figure 12. NCV8716x33xxx Dropout Voltage vs. Output Current

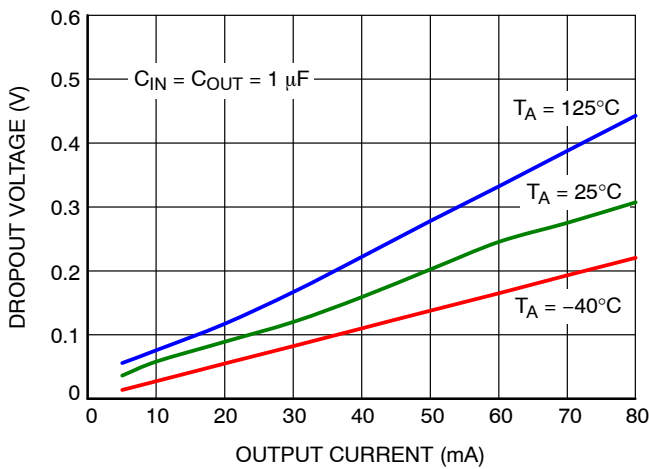

Figure 13. NCV8716x50xxx Dropout Voltage vs. Output Current

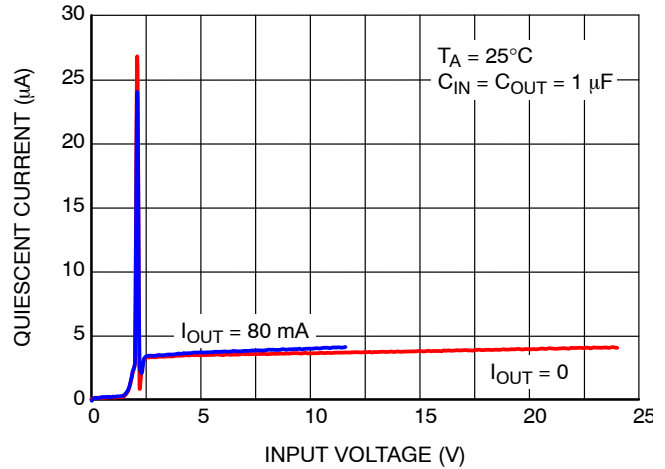

Figure 14. NCV8716x15xxx Ground Current vs. Input Voltage

TYPICAL CHARACTERISTICS

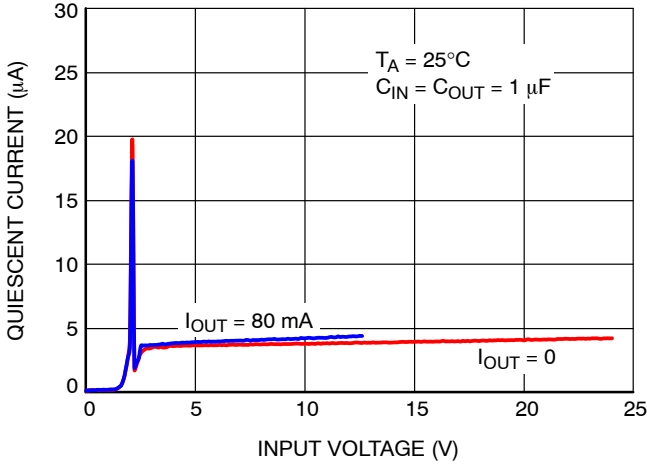

Figure 15. NCV8716x25xxx Ground Current vs. Input Voltage

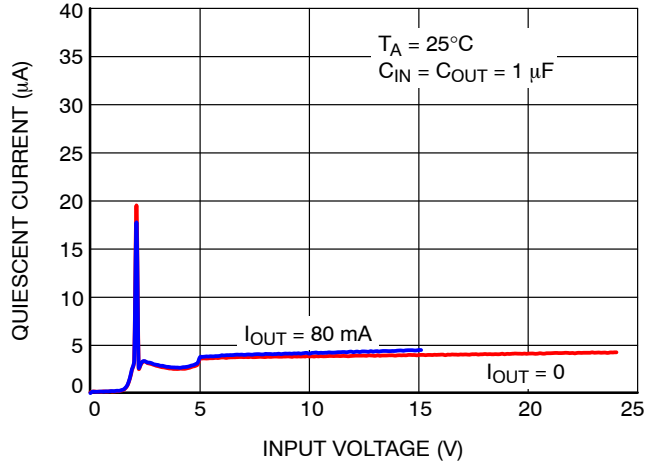

Figure 16. NCV8716x50xxx Ground Current vs. Input Voltage

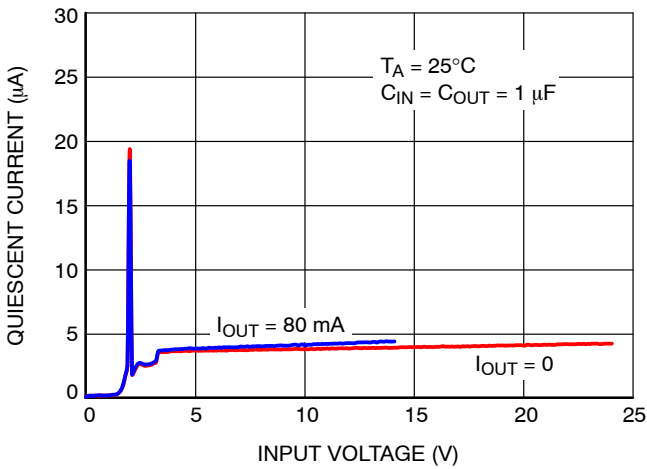

Figure 17. NCV8716x33xxx Ground Current vs. Input Voltage

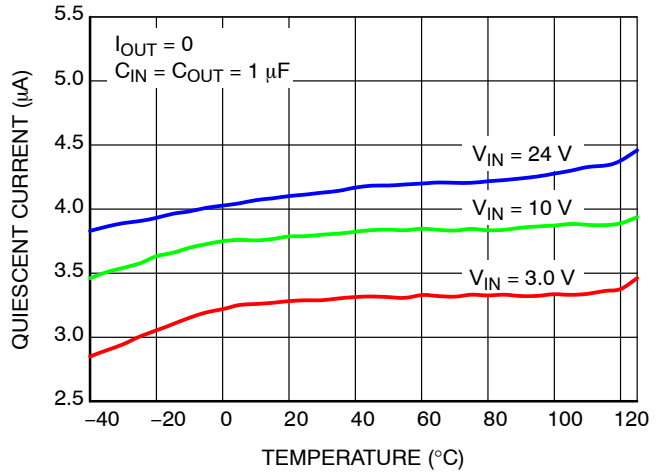

Figure 18. NCV8716x15xxx Quiescent Current vs. Temperature

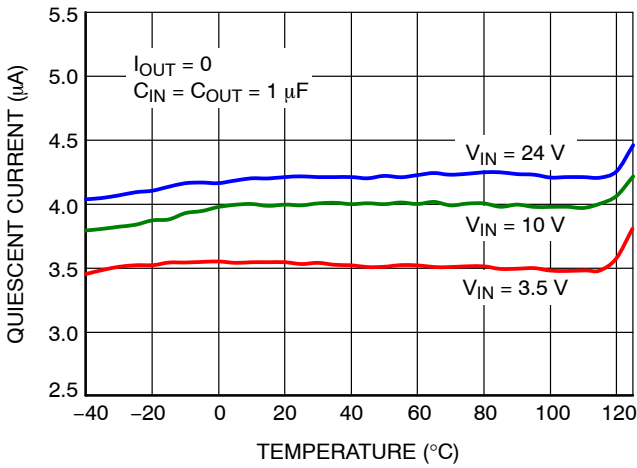

Figure 19. NCV8716x25xxx Quiescent Current vs. Temperature

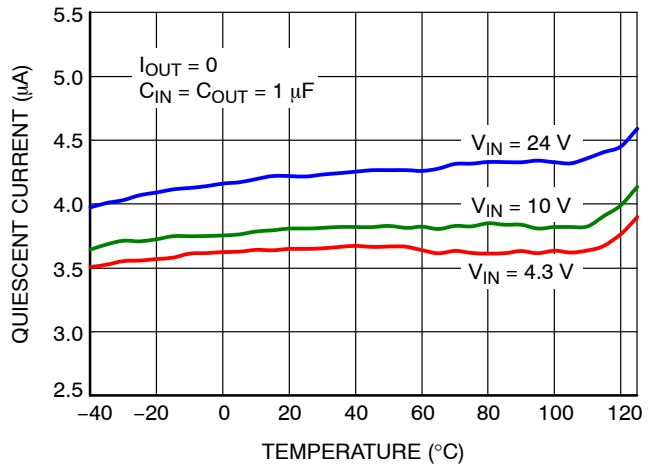

Figure 20. NCV8716x33xxx Quiescent Current vs. Temperature

TYPICAL CHARACTERISTICS

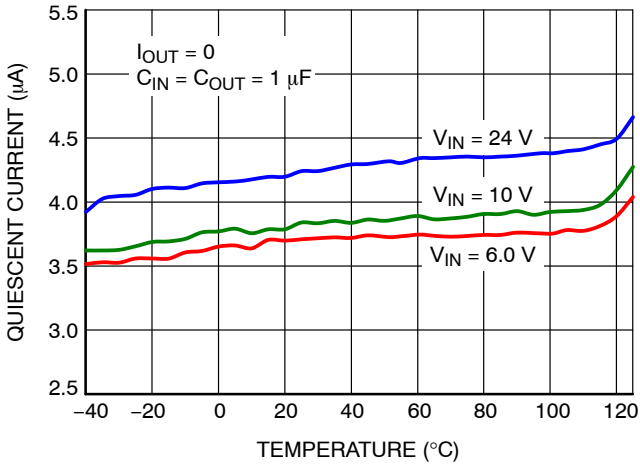

Figure 21. NVP716x50xxx Quiescent Current vs. Temperature

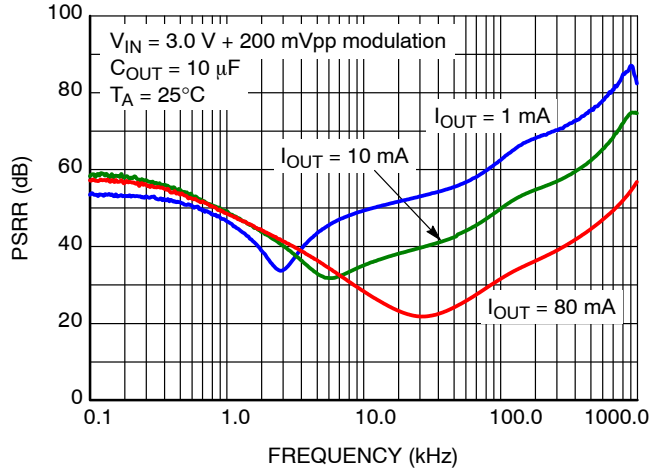

Figure 22. NCV8716x15xxx PSRR vs. Frequency

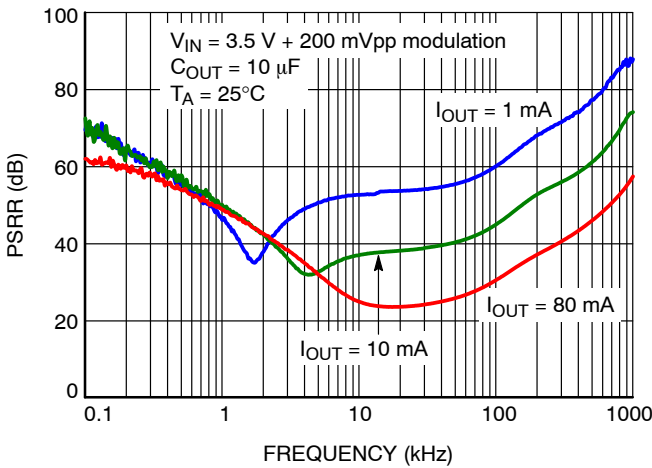

Figure 23. NCV8716x25xxx PSRR vs. Frequency

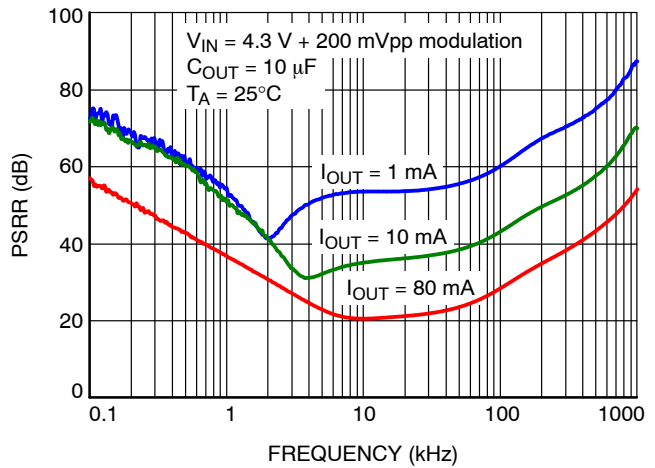

Figure 24. NCV8716x33xxx PSRR vs. Frequency

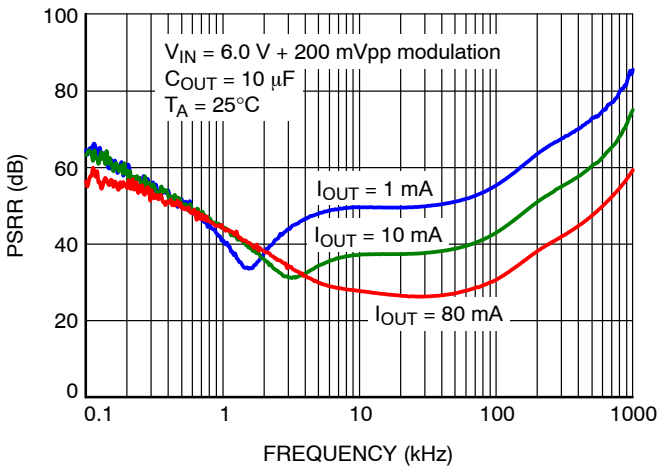

Figure 25. NCV8716x50xxx PSRR vs. Frequency

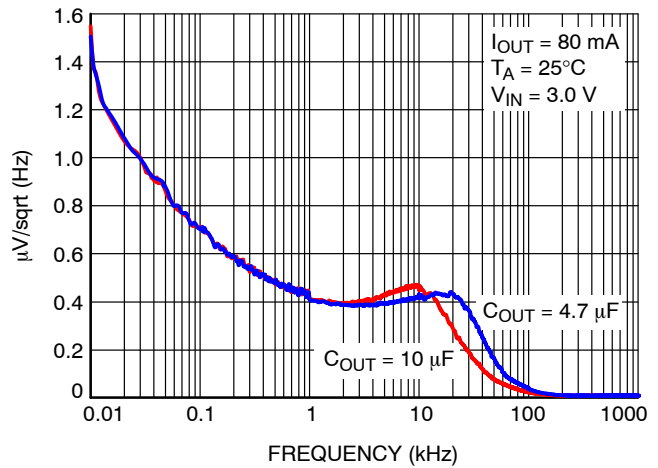

Figure 26. NCV8716x15xxx Output Spectral Noise Density vs. Frequency

TYPICAL CHARACTERISTICS

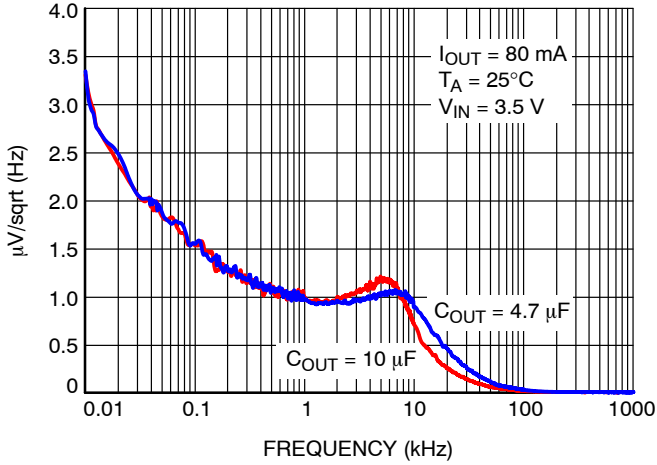

Figure 27. NCV8716x25xxx Output Spectral Noise Density vs. Frequency

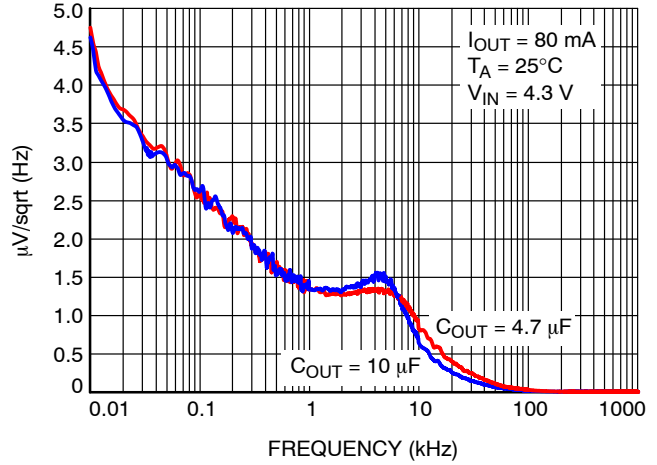

Figure 28. NCV8716x33xxx Output Spectral Noise Density vs. Frequency

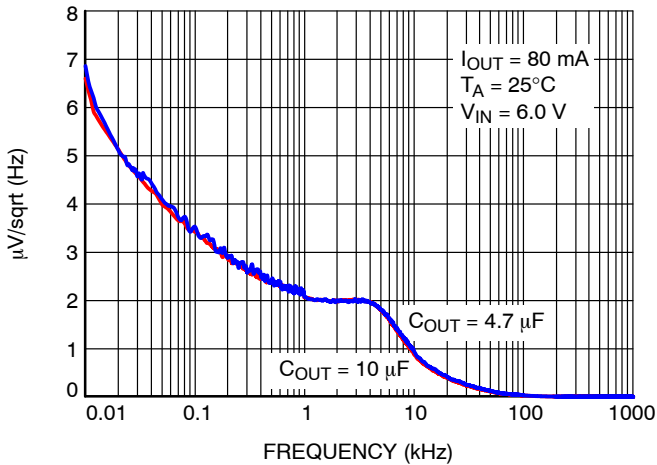

Figure 29. NCV8716x50xxx Output Spectral Noise Density vs. Frequency

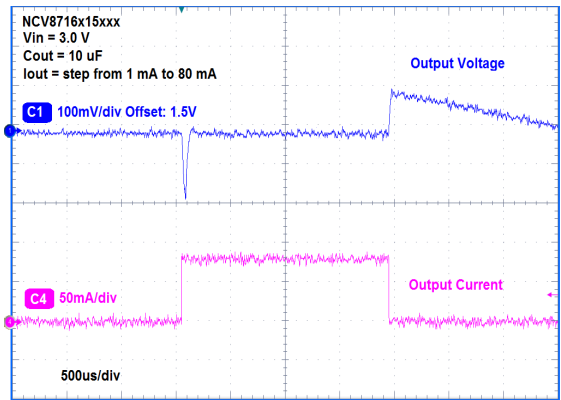

Figure 30. Load Transient Response

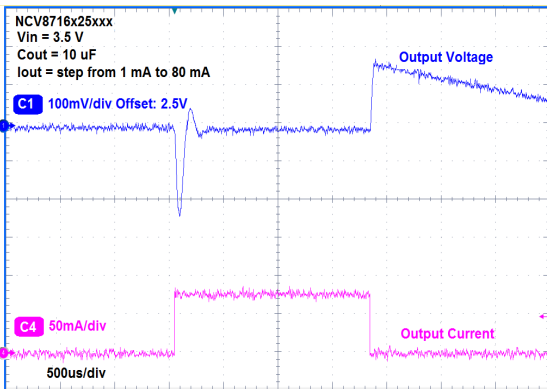

Figure 31. Load Transient Response

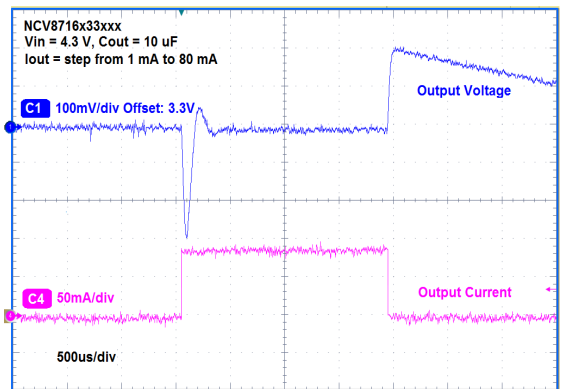

Figure 32. Load Transient Response

TYPICAL CHARACTERISTICS

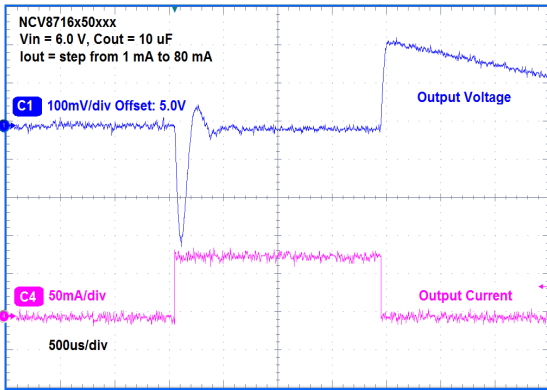

Figure 33. Load Transient Response

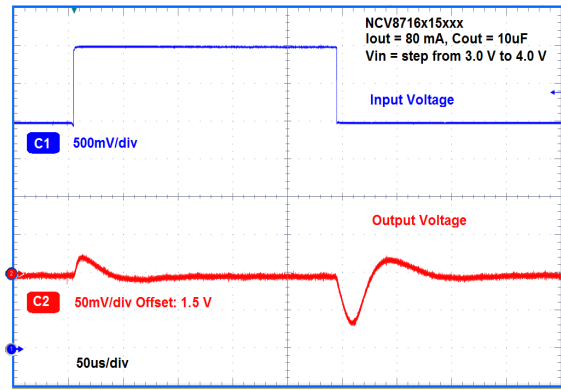

Figure 34. Line Transient Response

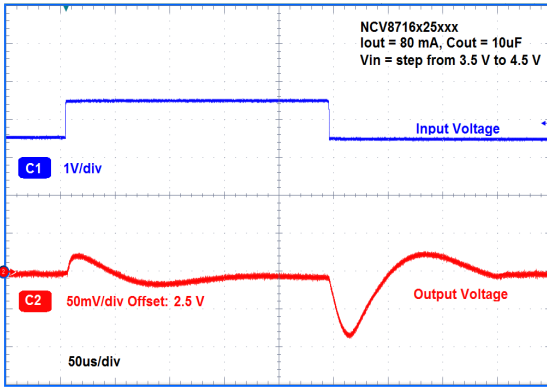

Figure 35. Line Transient Response

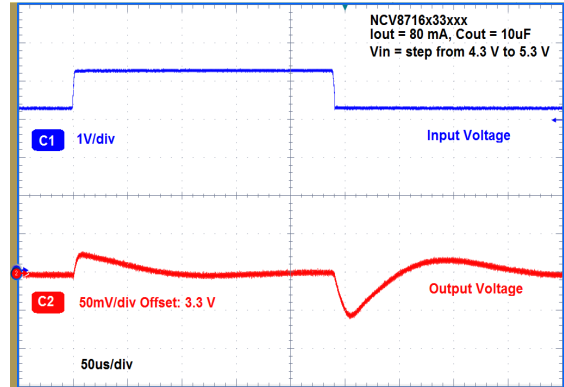

Figure 36. Line Transient Response

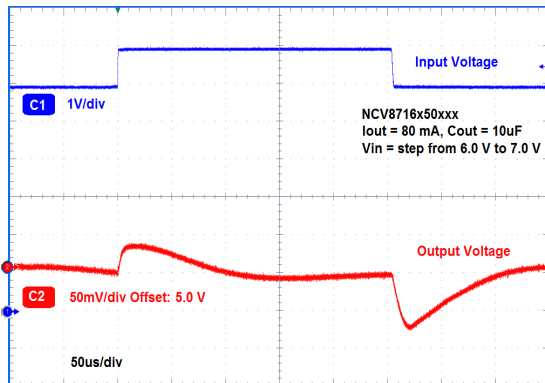

Figure 37. Line Transient Response

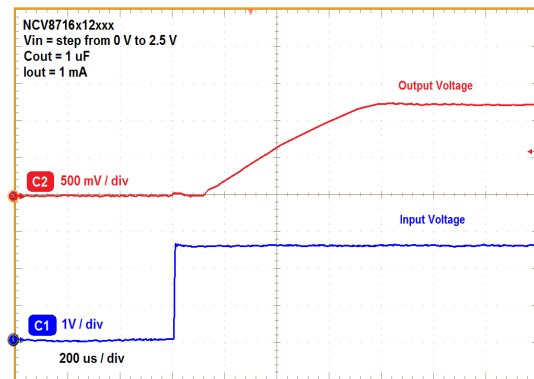

Figure 38. Input Voltage Turn-On Response

# NCV8716

## TYPICAL CHARACTERISTICS

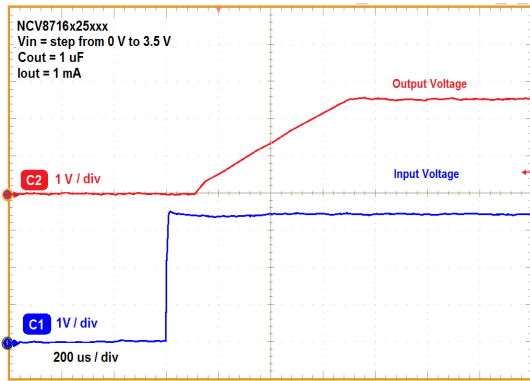

Figure 39. Input Voltage Turn-On Response

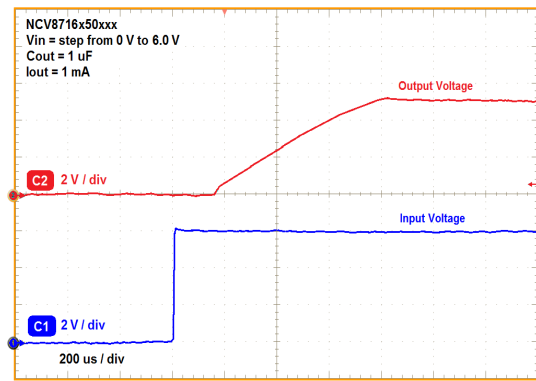

Figure 40. Input Voltage Turn-On Response

# NCV8716

## APPLICATIONS INFORMATION

The NCV8716 is the member of new family of Wide Input Voltage Range Low Dropout Regulators which delivers Ultra Low Ground Current consumption, Good Noise and Power Supply Rejection Ratio Performance.

### Input Decoupling ( $C_{IN}$ )

It is recommended to connect at least 0.1  $\mu$ F Ceramic X5R or X7R capacitor between IN and GND pin of the device. This capacitor will provide a low impedance path for any unwanted AC signals or Noise superimposed onto constant Input Voltage. The good input capacitor will limit the influence of input trace inductances and source resistance during sudden load current changes.

Higher capacitance and lower ESR Capacitors will improve the overall line transient response.

### Output Decoupling ( $C_{OUT}$ )

The NCV8716 does not require a minimum Equivalent Series Resistance (ESR) for the output capacitor. The device is designed to be stable with standard ceramics capacitors with values of 0.47  $\mu$ F or greater up to 10  $\mu$ F. The X5R and X7R types have the lowest capacitance variations over temperature thus they are recommended.

### Power Dissipation and Heat sinking

The maximum power dissipation supported by the device is dependent upon board design and layout. Mounting pad configuration on the PCB, the board material, and the ambient temperature affect the rate of junction temperature rise for the part. The maximum power dissipation the NCV8716 can handle is given by:

$$P_{D(MAX)} = \frac{[T_{J(MAX)} - T_A]}{R_{\theta JA}} \quad (\text{eq. 1})$$

The power dissipated by the NCV8716 for given application conditions can be calculated from the following equations:

$$P_D \approx V_{IN}(I_{GND} + I_{OUT}) + I_{OUT}(V_{IN} - V_{OUT}) \quad (\text{eq. 2})$$

or

$$V_{IN(MAX)} \approx \frac{P_{D(MAX)} + (V_{OUT} \times I_{OUT})}{I_{OUT} + I_{GND}} \quad (\text{eq. 3})$$

For reliable operation, junction temperature should be limited to +125°C maximum.

### Hints

$V_{IN}$  and GND printed circuit board traces should be as wide as possible. When the impedance of these traces is high, there is a chance to pick up noise or cause the regulator to malfunction. Place external components, especially the output capacitor, as close as possible to the NCV8716, and make traces as short as possible.

## ORDERING INFORMATION

Device	Voltage Option	Marking	Package	Shipping <sup>†</sup>
NCV8716MT15TBG	1.5 V	7C	WDFN6 (Pb-Free)	3000 / Tape & Reel
NCV8716MT18TBG	1.8 V	7D		
NCV8716MT25TBG	2.5 V	7E		
NCV8716MT28TBG	2.8 V	7J		
NCV8716MT30TBG	3.0 V	7F		
NCV8716MT33TBG	3.3 V	7G		
NCV8716MT50TBG	5.0 V	7H		

<sup>†</sup>For information on tape and reel specifications, including part orientation and tape sizes, please refer to our Tape and Reel Packaging Specifications Brochure, BRD8011/D.

# NCV8716

## PACKAGE DIMENSIONS

WDFN6 2x2, 0.65P  
CASE 511BR  
ISSUE B

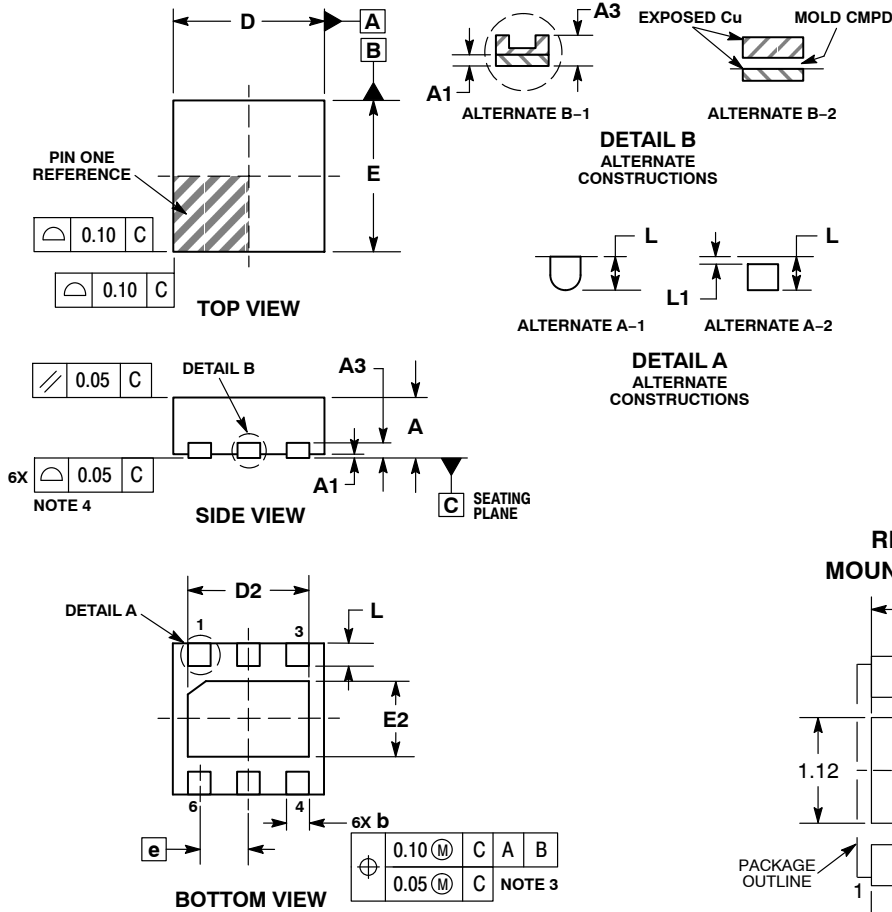

**NOTES:**

1. DIMENSIONING AND TOLERANCING PER ASME Y14.5M, 1994.
2. CONTROLLING DIMENSION: MILLIMETERS.
3. DIMENSION b APPLIES TO PLATED TERMINAL AND IS MEASURED BETWEEN 0.15 AND 0.25 mm FROM THE TERMINAL TIP.
4. COPLANARITY APPLIES TO THE EXPOSED PAD AS WELL AS THE TERMINALS.
5. FOR DEVICES CONTAINING WETTABLE FLANK OPTION, DETAIL A ALTERNATE CONSTRUCTION A-2 AND DETAIL B ALTERNATE CONSTRUCTION B-2 ARE NOT APPLICABLE.

DIM	MILLIMETERS	
	MIN	MAX
A	0.70	0.80
A1	0.00	0.05
A3	0.20	REF
b	0.25	0.35
D	2.00 BSC	
D2	1.50	1.70
E	2.00 BSC	
E2	0.90	1.10
e	0.65 BSC	
L	0.20	0.40
L1	---	0.15

### RECOMMENDED MOUNTING FOOTPRINT\*

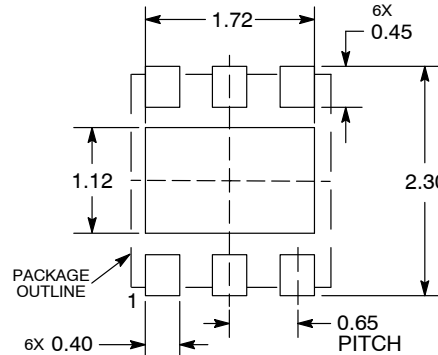

DIMENSIONS: MILLIMETERS

\*For additional information on our Pb-Free strategy and soldering details, please download the ON Semiconductor Soldering and Mounting Techniques Reference Manual, SOLDERRM/D.

ON Semiconductor and are trademarks of Semiconductor Components Industries, LLC dba ON Semiconductor or its subsidiaries in the United States and/or other countries. ON Semiconductor owns the rights to a number of patents, trademarks, copyrights, trade secrets, and other intellectual property. A listing of ON Semiconductor's product/patent coverage may be accessed at [www.onsemi.com/site/pdf/Patent-Marketing.pdf](http://www.onsemi.com/site/pdf/Patent-Marketing.pdf). ON Semiconductor reserves the right to make changes without further notice to any products herein. ON Semiconductor makes no warranty, representation or guarantee regarding the suitability of its products for any particular purpose, nor does ON Semiconductor assume any liability arising out of the application or use of any product or circuit, and specifically disclaims any and all liability, including without limitation special, consequential or incidental damages. Buyer is responsible for its products and applications using ON Semiconductor products, including compliance with all laws, regulations and safety requirements or standards, regardless of any support or applications information provided by ON Semiconductor. "Typical" parameters which may be provided in ON Semiconductor data sheets and/or specifications can and do vary in different applications and actual performance may vary over time. All operating parameters, including "Typicals" must be validated for each customer application by customer's technical experts. ON Semiconductor does not convey any license under its patent rights nor the rights of others. ON Semiconductor products are not designed, intended, or authorized for use as a critical component in life support systems or any FDA Class 3 medical devices or medical devices with a same or similar classification in a foreign jurisdiction or any devices intended for implantation in the human body. Should Buyer purchase or use ON Semiconductor products for any such unintended or unauthorized application, Buyer shall indemnify and hold ON Semiconductor and its officers, employees, subsidiaries, affiliates, and distributors harmless against all claims, costs, damages, and expenses, and reasonable attorney fees arising out of, directly or indirectly, any claim of personal injury or death associated with such unintended or unauthorized use, even if such claim alleges that ON Semiconductor was negligent regarding the design or manufacture of the part. ON Semiconductor is an Equal Opportunity/Affirmative Action Employer. This literature is subject to all applicable copyright laws and is not for resale in any manner.

### PUBLICATION ORDERING INFORMATION

**LITERATURE FULFILLMENT:**

Literature Distribution Center for ON Semiconductor  
19521 E. 32nd Pkwy, Aurora, Colorado 80011 USA  
Phone: 303-675-2175 or 800-344-3860 Toll Free USA/Canada  
Fax: 303-675-2176 or 800-344-3867 Toll Free USA/Canada  
Email: [orderlit@onsemi.com](mailto:orderlit@onsemi.com)

**N. American Technical Support:** 800-282-9855 Toll Free  
USA/Canada  
**Europe, Middle East and Africa Technical Support:**  
Phone: 421 33 790 2910  
**Japan Customer Focus Center**  
Phone: 81-3-5817-1050

**ON Semiconductor Website:** [www.onsemi.com](http://www.onsemi.com)

**Order Literature:** <http://www.onsemi.com/orderlit>

For additional information, please contact your local Sales Representative