



ON Semiconductor®

FDB035AN06A0-F085

N-Channel PowerTrench® MOSFET 60V, 80A, 3.5mΩ

Features

- $r_{DS(ON)} = 3.2m\Omega$ (Typ.), $V_{GS} = 10V$, $I_D = 80A$
- $Q_g(tot) = 95nC$ (Typ.), $V_{GS} = 10V$
- Low Miller Charge
- Low Q_{rr} Body Diode
- UIS Capability (Single Pulse and Repetitive Pulse)
- Qualified to AEC Q101

Formerly developmental type 82584

Applications

- Motor / Body Load Control
- ABS Systems
- Powertrain Management
- Injection Systems
- DC-DC converters and Off-line UPS
- Distributed Power Architectures and VRMs
- Primary Switch for 12V and 24V systems

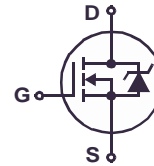
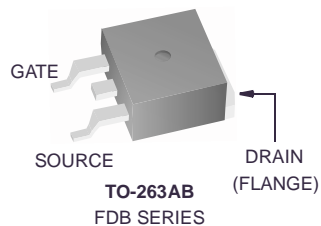

MOSFET Maximum Ratings $T_C = 25^\circ C$ unless otherwise noted

Symbol	Parameter	Ratings	Units
V_{DSS}	Drain to Source Voltage	60	V
V_{GS}	Gate to Source Voltage	± 20	V
I_D	Drain Current		
	Continuous ($T_C < 153^\circ C$, $V_{GS} = 10V$)	80	A
	Continuous ($T_{amb} = 25^\circ C$, $V_{GS} = 10V$, with $R_{\theta JA} = 43^\circ C/W$)	22	A
	Pulsed	Figure 4	A
E_{AS}	Single Pulse Avalanche Energy (Note 1)	625	mJ
P_D	Power dissipation	310	W
	Derate above $25^\circ C$	2.07	W/ $^\circ C$
T_J, T_{STG}	Operating and Storage Temperature	-55 to 175	$^\circ C$

Thermal Characteristics

$R_{\theta JC}$	Thermal Resistance Junction to Case TO-263	0.48	$^\circ C/W$
$R_{\theta JA}$	Thermal Resistance Junction to Ambient TO-263, (Note 2)	62	$^\circ C/W$
$R_{\theta JA}$	Thermal Resistance Junction to Ambient TO-263, 1in ² copper pad area	43	$^\circ C/W$

Package Marking and Ordering Information

Device Marking	Device	Package	Reel Size	Tape Width	Quantity
FDB035AN06A0	FDB035AN06A0-F085	TO-263AB	330mm	24mm	800 units

Electrical Characteristics $T_C = 25^\circ\text{C}$ unless otherwise noted

Symbol	Parameter	Test Conditions	Min	Typ	Max	Units
--------	-----------	-----------------	-----	-----	-----	-------

Off Characteristics

B_{VDSS}	Drain to Source Breakdown Voltage	$I_D = 250\mu\text{A}, V_{GS} = 0\text{V}$	60	-	-	V
I_{DSS}	Zero Gate Voltage Drain Current	$V_{DS} = 50\text{V}$	-	-	1	μA
		$V_{GS} = 0\text{V}$ $T_C = 150^\circ\text{C}$	-	-	250	
I_{GSS}	Gate to Source Leakage Current	$V_{GS} = \pm 20\text{V}$	-	-	± 100	nA

On Characteristics

$V_{GS(TH)}$	Gate to Source Threshold Voltage	$V_{GS} = V_{DS}, I_D = 250\mu\text{A}$	2	-	4	V
$r_{DS(ON)}$	Drain to Source On Resistance	$I_D = 80\text{A}, V_{GS} = 10\text{V}$	-	0.0032	0.0035	Ω
		$I_D = 80\text{A}, V_{GS} = 10\text{V}, T_J = 175^\circ\text{C}$	-	0.0065	0.0071	

Dynamic Characteristics

C_{ISS}	Input Capacitance	$V_{DS} = 25\text{V}, V_{GS} = 0\text{V}, f = 1\text{MHz}$	-	6400	-	pF
C_{OSS}	Output Capacitance		-	1123	-	pF
C_{RSS}	Reverse Transfer Capacitance		-	367	-	pF
$Q_{g(TOT)}$	Total Gate Charge at 10V	$V_{GS} = 0\text{V to } 10\text{V}$	-	95	124	nC
$Q_{g(TH)}$	Threshold Gate Charge	$V_{GS} = 0\text{V to } 2\text{V}$	-	12	15	nC
Q_{gs}	Gate to Source Gate Charge	$V_{DD} = 30\text{V}$ $I_D = 80\text{A}$ $I_g = 1.0\text{mA}$	-	30	-	nC
Q_{gs2}	Gate Charge Threshold to Plateau		-	18	-	nC
Q_{gd}	Gate to Drain "Miller" Charge		-	24	-	nC

Switching Characteristics ($V_{GS} = 10\text{V}$)

t_{ON}	Turn-On Time	$V_{DD} = 30\text{V}, I_D = 80\text{A}$ $V_{GS} = 10\text{V}, R_{GS} = 2.4\Omega$	-	-	163	ns
$t_{d(ON)}$	Turn-On Delay Time		-	15	-	ns
t_r	Rise Time		-	93	-	ns
$t_{d(OFF)}$	Turn-Off Delay Time		-	38	-	ns
t_f	Fall Time		-	13	-	ns
t_{OFF}	Turn-Off Time		-	-	75	ns

Drain-Source Diode Characteristics

V_{SD}	Source to Drain Diode Voltage	$I_{SD} = 80\text{A}$	-	-	1.25	V
		$I_{SD} = 40\text{A}$	-	-	1.0	V
t_{rr}	Reverse Recovery Time	$I_{SD} = 75\text{A}, dI_{SD}/dt = 100\text{A}/\mu\text{s}$	-	-	38	ns
Q_{RR}	Reverse Recovered Charge	$I_{SD} = 75\text{A}, dI_{SD}/dt = 100\text{A}/\mu\text{s}$	-	-	39	nC

Notes:

- Starting $T_J = 25^\circ\text{C}$, $L = 0.255\text{mH}$, $I_{AS} = 70\text{A}$.
- Pulse Width = 100s

Typical Characteristics $T_C = 25^\circ\text{C}$ unless otherwise noted

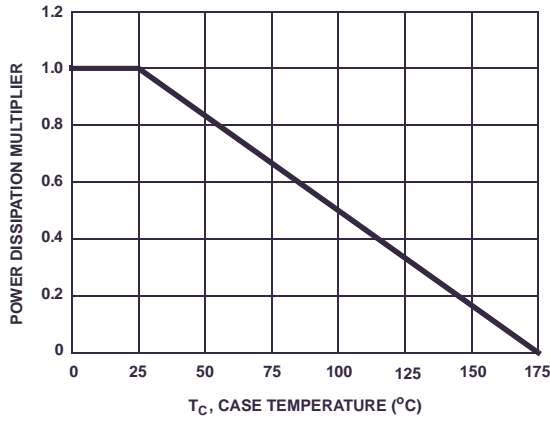

Figure 1. Normalized Power Dissipation vs Ambient Temperature

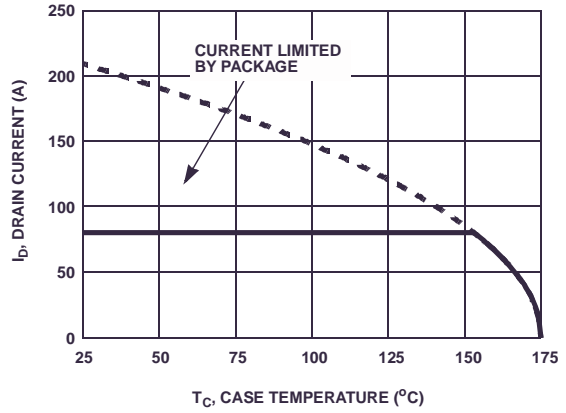

Figure 2. Maximum Continuous Drain Current vs Case Temperature

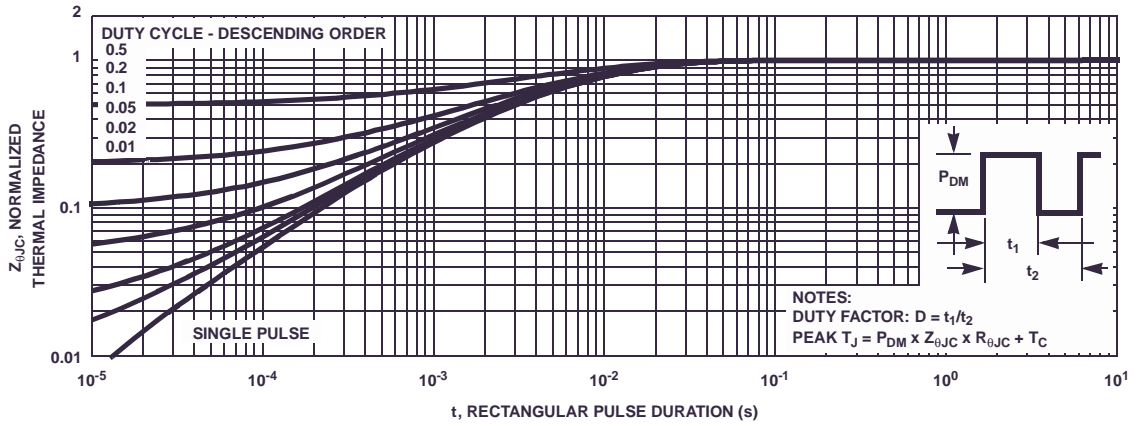

Figure 3. Normalized Maximum Transient Thermal Impedance

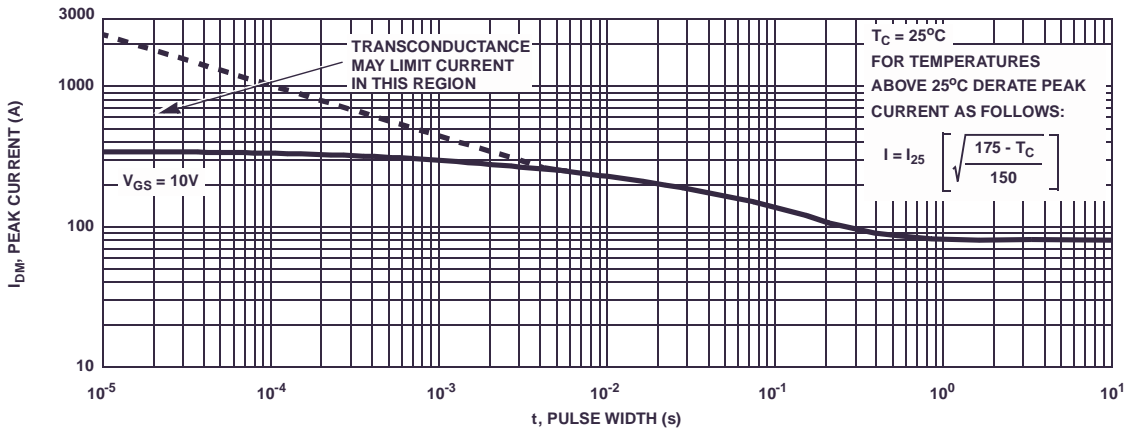

Figure 4. Peak Current Capability

Typical Characteristics $T_C = 25^\circ\text{C}$ unless otherwise noted

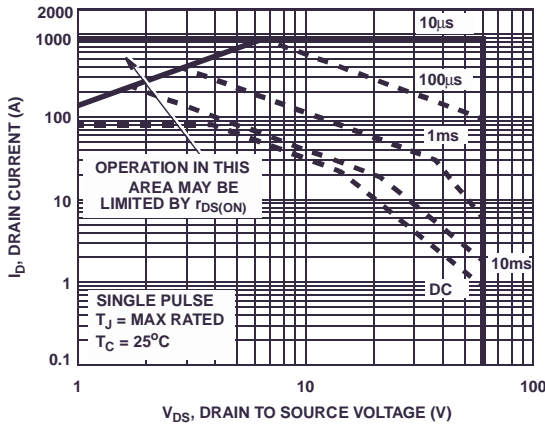

Figure 5. Forward Bias Safe Operating Area

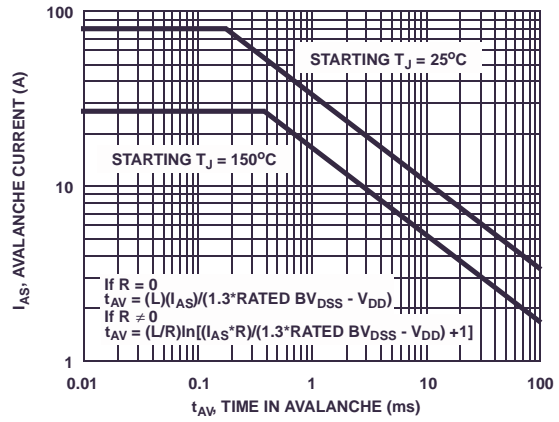

Figure 6. Unclamped Inductive Switching Capability

NOTE: Refer to ON Semiconductor Application Notes AN7514 and AN7515

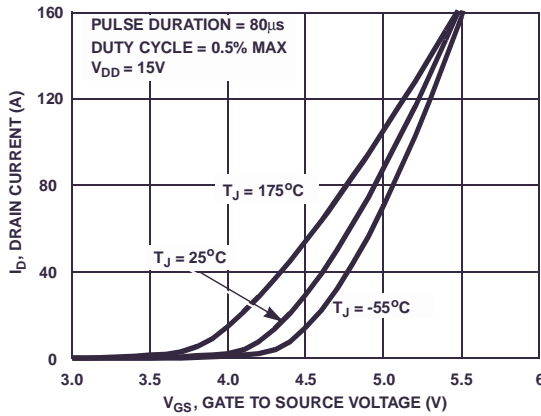

Figure 7. Transfer Characteristics

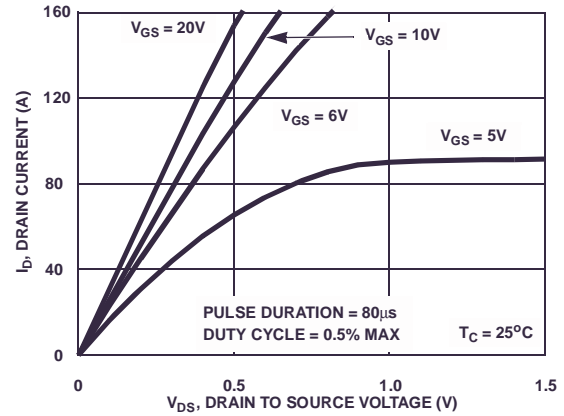

Figure 8. Saturation Characteristics

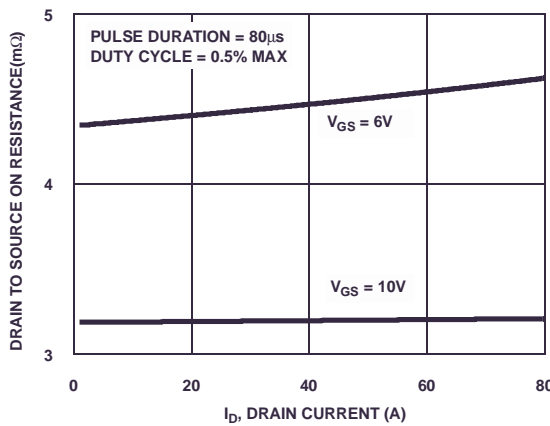

Figure 9. Drain to Source On Resistance vs Drain Current

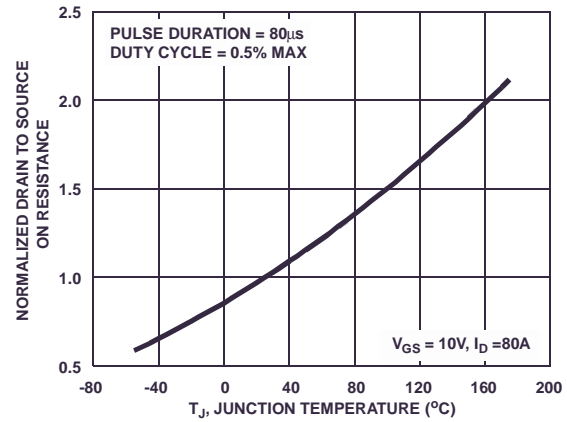

Figure 10. Normalized Drain to Source On Resistance vs Junction Temperature

Typical Characteristics $T_C = 25^\circ\text{C}$ unless otherwise noted

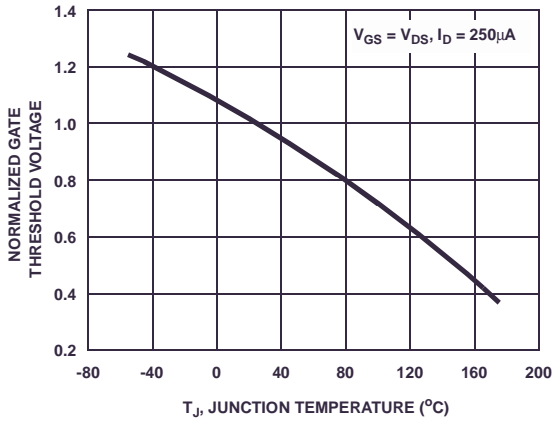

Figure 11. Normalized Gate Threshold Voltage vs Junction Temperature

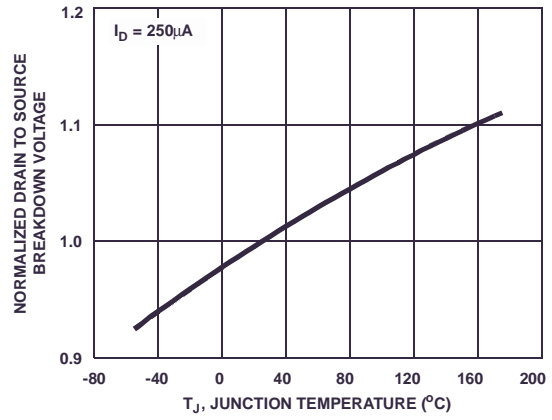

Figure 12. Normalized Drain to Source Breakdown Voltage vs Junction Temperature

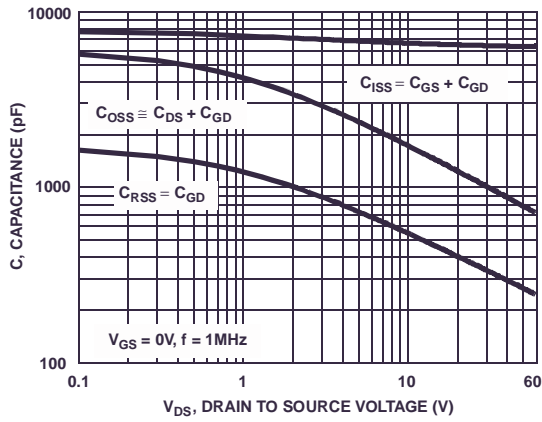

Figure 13. Capacitance vs Drain to Source Voltage

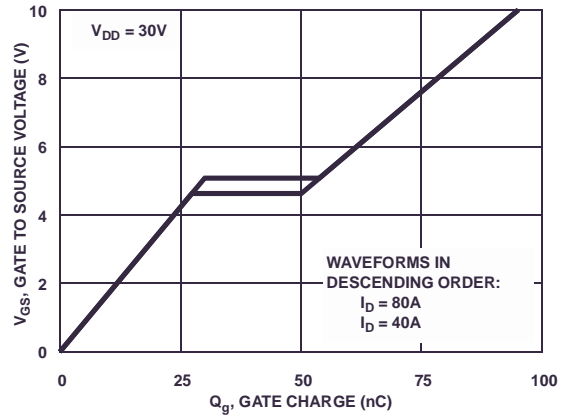

Figure 14. Gate Charge Waveforms for Constant Gate Current

Test Circuits and Waveforms

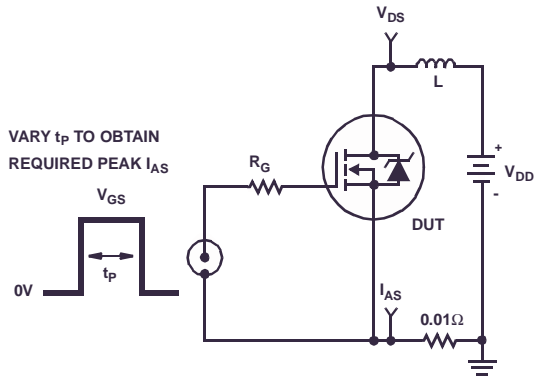

Figure 15. Unclamped Energy Test Circuit

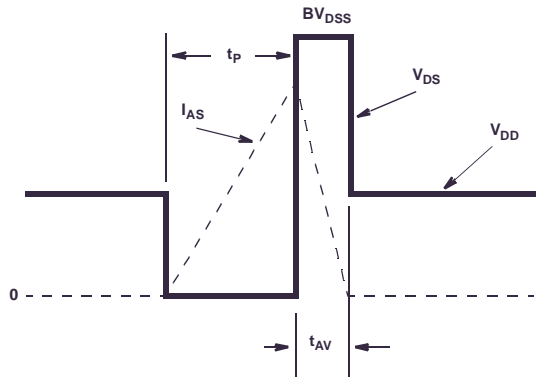

Figure 16. Unclamped Energy Waveforms

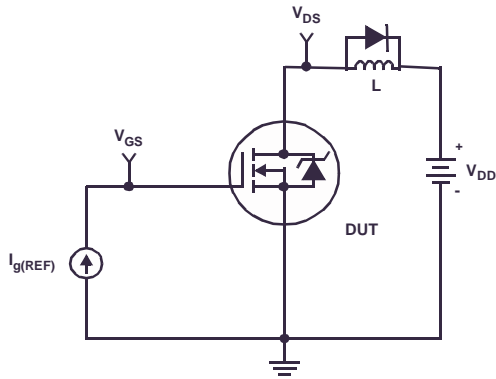

Figure 17. Gate Charge Test Circuit

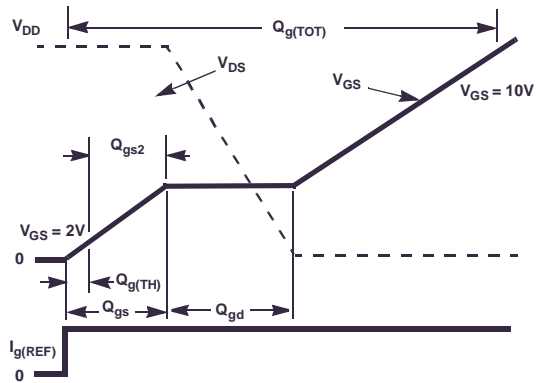

Figure 18. Gate Charge Waveforms

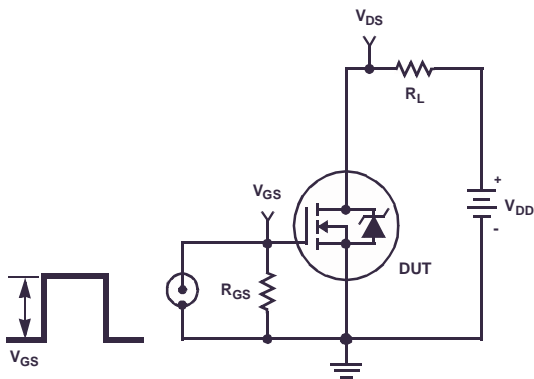

Figure 19. Switching Time Test Circuit

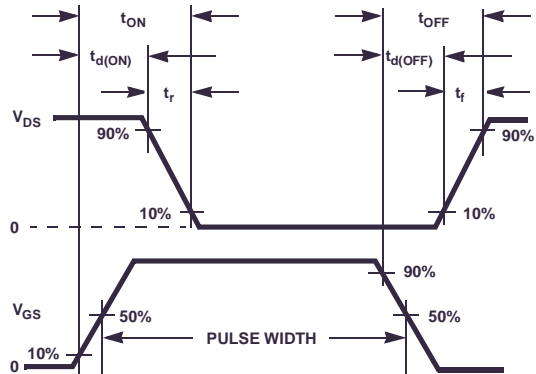

Figure 20. Switching Time Waveforms

Thermal Resistance vs. Mounting Pad Area

The maximum rated junction temperature, T_{JM} , and the thermal resistance of the heat dissipating path determines the maximum allowable device power dissipation, P_{DM} , in an application. Therefore the application's ambient temperature, T_A ($^{\circ}C$), and thermal resistance $R_{\theta JA}$ ($^{\circ}C/W$) must be reviewed to ensure that T_{JM} is never exceeded. Equation 1 mathematically represents the relationship and serves as the basis for establishing the rating of the part.

$$P_{DM} = \frac{(T_{JM} - T_A)}{R_{\theta JA}} \quad (EQ. 1)$$

In using surface mount devices such as the TO-263 package, the environment in which it is applied will have a significant influence on the part's current and maximum power dissipation ratings. Precise determination of P_{DM} is complex and influenced by many factors:

1. Mounting pad area onto which the device is attached and whether there is copper on one side or both sides of the board.
2. The number of copper layers and the thickness of the board.
3. The use of external heat sinks.
4. The use of thermal vias.
5. Air flow and board orientation.
6. For non steady state applications, the pulse width, the duty cycle and the transient thermal response of the part, the board and the environment they are in.

ON Semiconductor provides thermal information to assist the designer's preliminary application evaluation. Figure 21

defines the $R_{\theta JA}$ for the device as a function of the top copper (component side) area. This is for a horizontally positioned FR-4 board with 1oz copper after 1000 seconds of steady state power with no air flow. This graph provides the necessary information for calculation of the steady state junction temperature or power dissipation. Pulse applications can be evaluated using the ON Semiconductor device Spice thermal model or manually utilizing the normalized maximum transient thermal impedance curve.

Thermal resistances corresponding to other copper areas can be obtained from Figure 21 or by calculation using Equation 2 or 3. Equation 2 is used for copper area defined in inches square and equation 3 is for area in centimeters square. The area, in square inches or square centimeters is the top copper area including the gate and source pads.

$$R_{\theta JA} = 26.51 + \frac{19.84}{(0.262 + Area)} \quad (EQ. 2)$$

Area in Inches Squared

$$R_{\theta JA} = 26.51 + \frac{128}{(1.69 + Area)} \quad (EQ. 3)$$

Area in Centimeters Squared

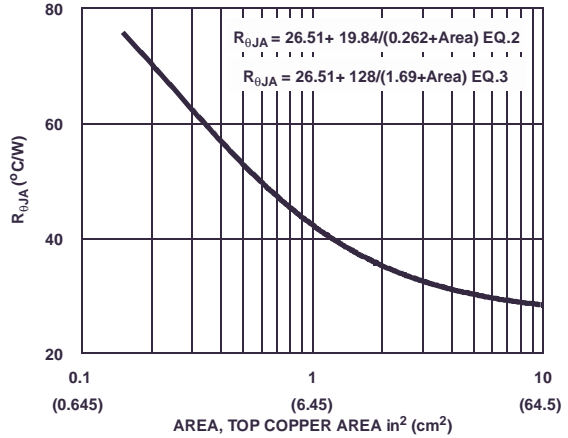

Figure 21. Thermal Resistance vs Mounting Pad Area

SABER Electrical Model

rev July 4, 2002

template FDB035AN06A0 n2,n1,n3 = m_temp

electrical n2,n1,n3
number m_temp=25

```
{
var i iscl
dp..model dbodymod = (isl=2.4e-11,nl=1.04,rs=1.65e-3,trs1=2.7e-3,trs2=2e-7,cjo=4.35e-9,m=5.4e-1,tt=1e-9,xti=3.9)
dp..model dbreakmod = (rs=1.5e-1,trs1=1e-3,trs2=-8.9e-6)
dp..model dplcapmod = (cjo=1.7e-9,isl=10e-30,nl=10,m=0.47)
m..model mmedmod = (type=_n,vto=3.3,kp=9,is=1e-30,tox=1)
m..model mstrongmod = (type=_n,vto=4.00,kp=275,is=1e-30,tox=1)
m..model mweakmod = (type=_n,vto=2.72,kp=0.03,is=1e-30,tox=1,rs=0.1)
sw_vcsp..model s1amod = (ron=1e-5,roff=0.1,von=-4,voff=-1.5)
sw_vcsp..model s1bmod = (ron=1e-5,roff=0.1,von=-1.5,voff=-4)
sw_vcsp..model s2amod = (ron=1e-5,roff=0.1,von=-1,voff=0.5)
sw_vcsp..model s2bmod = (ron=1e-5,roff=0.1,von=0.5,voff=-1)
c.ca n12 n8 = 1.5e-9
c.cb n15 n14 = 1.5e-9
c.cin n6 n8 = 6.1e-9
```

```
dp.dbody n7 n5 = model=dbodymod
dp.dbreak n5 n11 = model=dbreakmod
dp.dplcap n10 n5 = model=dplcapmod
```

```
spe.ebreak n11 n7 n17 n18 = 69.3
spe.eds n14 n8 n5 n8 = 1
spe.egs n13 n8 n6 n8 = 1
spe.esg n6 n10 n6 n8 = 1
spe.evthres n6 n21 n19 n8 = 1
spe.evtemp n20 n6 n18 n22 = 1
```

```
i.it n8 n17 = 1
```

```
l.lgate n1 n9 = 4.81e-9
l.ldrain n2 n5 = 1.0e-9
l.lsource n3 n7 = 4.63e-9
```

```
res.rlgate n1 n9 = 48.1
res.rldrain n2 n5 = 10
res.rlsource n3 n7 = 46.3
```

```
m.mmed n16 n6 n8 n8 = model=mmedmod, temp=m_temp, l=1u, w=1u
m.mstrong n16 n6 n8 n8 = model=mstrongmod, temp=m_temp, l=1u, w=1u
m.mweak n16 n21 n8 n8 = model=mweakmod, temp=m_temp, l=1u, w=1u
```

```
res.rbreak n17 n18 = 1, tc1=9e-4,tc2=-9e-7
res.rdrain n50 n16 = 1e-4, tc1=4e-2,tc2=1.75e-4
res.rgate n9 n20 = 1.36
res.rslc1 n5 n51 = 1e-6, tc1=1e-3,tc2=1e-5
res.rslc2 n5 n50 = 1e3
res.rsource n8 n7 = 2.5e-3, tc1=5e-3,tc2=1e-6
res.rvthres n22 n8 = 1, tc1=-6.7e-3,tc2=-1.5e-5
res.rvtemp n18 n19 = 1, tc1=-2.5e-3,tc2=1e-6
sw_vcsp.s1a n6 n12 n13 n8 = model=s1amod
sw_vcsp.s1b n13 n12 n13 n8 = model=s1bmod
sw_vcsp.s2a n6 n15 n14 n13 = model=s2amod
sw_vcsp.s2b n13 n15 n14 n13 = model=s2bmod
```

```
v.vbat n22 n19 = dc=1
```

```
equations {
i (n51->n50) +=iscl
iscl: v(n51,n50) = ((v(n5,n51))/(1e-9+abs(v(n5,n51))))*((abs(v(n5,n51))*1e6/250)** 10)
}
```

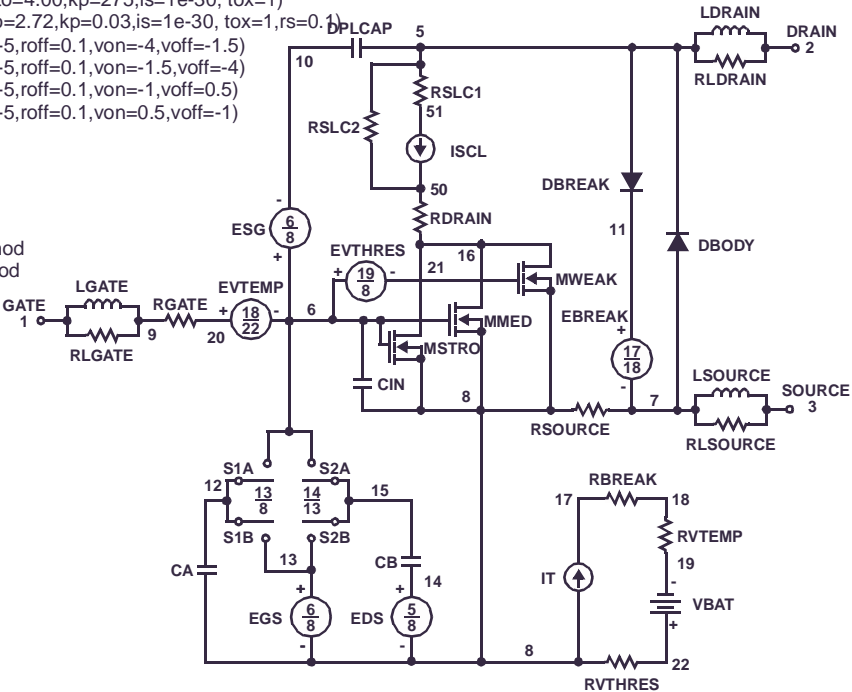

PSPICE Thermal Model

REV 23 July 4, 2002

FDB035AN06A0T

CTHERM1 TH 6 6.45e-3
 CTHERM2 6 5 3e-2
 CTHERM3 5 4 1.4e-2
 CTHERM4 4 3 1.65e-2
 CTHERM5 3 2 4.85e-2
 CTHERM6 2 TL 1e-1

RTHERM1 TH 6 3.24e-3
 RTHERM2 6 5 8.08e-3
 RTHERM3 5 4 2.28e-2
 RTHERM4 4 3 1e-1
 RTHERM5 3 2 1.1e-1
 RTHERM6 2 TL 1.4e-1

SABER Thermal Model

SABER thermal model FDB035AN06A0T
 template thermal_model th tl
 thermal_c th, tl

```
{
    ctherm.ctherm1 th 6 =6.45e-3
    ctherm.ctherm2 6 5 =3e-2
    ctherm.ctherm3 5 4 =1.4e-2
    ctherm.ctherm4 4 3 =1.65e-2
    ctherm.ctherm5 3 2 =4.85e-2
    ctherm.ctherm6 2 tl =1e-1
```

```
rtherm.rtherm1 th 6 =3.24e-3
rtherm.rtherm2 6 5 =8.08e-3
rtherm.rtherm3 5 4 =2.28e-2
rtherm.rtherm4 4 3 =1e-1
rtherm.rtherm5 3 2 =1.1e-1
rtherm.rtherm6 2 tl =1.4e-1
```

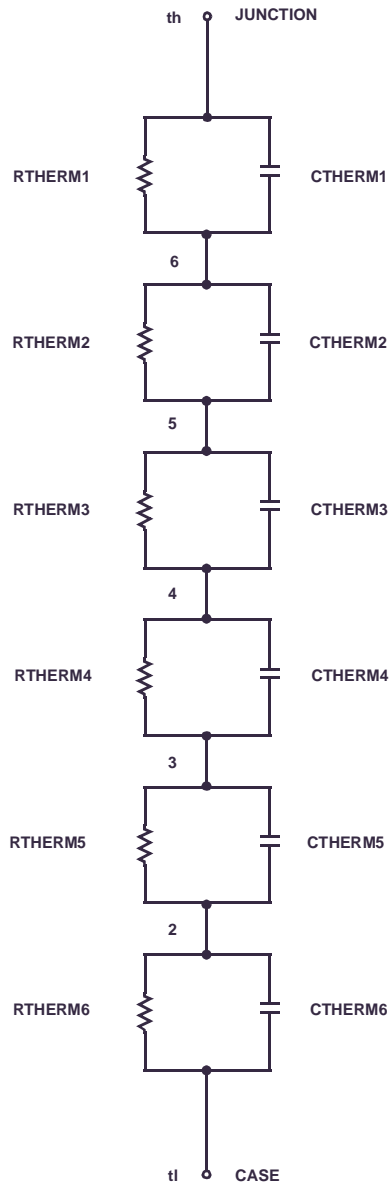

ON Semiconductor and  are trademarks of Semiconductor Components Industries, LLC dba ON Semiconductor or its subsidiaries in the United States and/or other countries. ON Semiconductor owns the rights to a number of patents, trademarks, copyrights, trade secrets, and other intellectual property. A listing of ON Semiconductor's product/patent coverage may be accessed at www.onsemi.com/site/pdf/Patent-Marking.pdf. ON Semiconductor reserves the right to make changes without further notice to any products herein. ON Semiconductor makes no warranty, representation or guarantee regarding the suitability of its products for any particular purpose, nor does ON Semiconductor assume any liability arising out of the application or use of any product or circuit, and specifically disclaims any and all liability, including without limitation special, consequential or incidental damages. Buyer is responsible for its products and applications using ON Semiconductor products, including compliance with all laws, regulations and safety requirements or standards, regardless of any support or applications information provided by ON Semiconductor. "Typical" parameters which may be provided in ON Semiconductor data sheets and/or specifications can and do vary in different applications and actual performance may vary over time. All operating parameters, including "Typicals" must be validated for each customer application by customer's technical experts. ON Semiconductor does not convey any license under its patent rights nor the rights of others. ON Semiconductor products are not designed, intended, or authorized for use as a critical component in life support systems or any FDA Class 3 medical devices or medical devices with a same or similar classification in a foreign jurisdiction or any devices intended for implantation in the human body. Should Buyer purchase or use ON Semiconductor products for any such unintended or unauthorized application, Buyer shall indemnify and hold ON Semiconductor and its officers, employees, subsidiaries, affiliates, and distributors harmless against all claims, costs, damages, and expenses, and reasonable attorney fees arising out of, directly or indirectly, any claim of personal injury or death associated with such unintended or unauthorized use, even if such claim alleges that ON Semiconductor was negligent regarding the design or manufacture of the part. ON Semiconductor is an Equal Opportunity/Affirmative Action Employer. This literature is subject to all applicable copyright laws and is not for resale in any manner.

PUBLICATION ORDERING INFORMATION

LITERATURE FULFILLMENT:

Literature Distribution Center for ON Semiconductor
19521 E. 32nd Pkwy, Aurora, Colorado 80011 USA
Phone: 303-675-2175 or 800-344-3860 Toll Free USA/Canada
Fax: 303-675-2176 or 800-344-3867 Toll Free USA/Canada
Email: orderlit@onsemi.com

N. American Technical Support: 800-282-9855 Toll Free
USA/Canada
Europe, Middle East and Africa Technical Support:
Phone: 421 33 790 2910
Japan Customer Focus Center
Phone: 81-3-5817-1050

ON Semiconductor Website: www.onsemi.com
Order Literature: <http://www.onsemi.com/orderlit>

For additional information, please contact your local Sales Representative