



MCP215X Data Logger Demo Board User's Guide

Note the following details of the code protection feature on Microchip devices:

- Microchip products meet the specification contained in their particular Microchip Data Sheet.
- Microchip believes that its family of products is one of the most secure families of its kind on the market today, when used in the intended manner and under normal conditions.
- There are dishonest and possibly illegal methods used to breach the code protection feature. All of these methods, to our knowledge, require using the Microchip products in a manner outside the operating specifications contained in Microchip's Data Sheets. Most likely, the person doing so is engaged in theft of intellectual property.
- Microchip is willing to work with the customer who is concerned about the integrity of their code.
- Neither Microchip nor any other semiconductor manufacturer can guarantee the security of their code. Code protection does not mean that we are guaranteeing the product as "unbreakable."

Code protection is constantly evolving. We at Microchip are committed to continuously improving the code protection features of our products. Attempts to break Microchip's code protection feature may be a violation of the Digital Millennium Copyright Act. If such acts allow unauthorized access to your software or other copyrighted work, you may have a right to sue for relief under that Act.

Information contained in this publication regarding device applications and the like is provided only for your convenience and may be superseded by updates. It is your responsibility to ensure that your application meets with your specifications. MICROCHIP MAKES NO REPRESENTATIONS OR WARRANTIES OF ANY KIND WHETHER EXPRESS OR IMPLIED, WRITTEN OR ORAL, STATUTORY OR OTHERWISE, RELATED TO THE INFORMATION, INCLUDING BUT NOT LIMITED TO ITS CONDITION, QUALITY, PERFORMANCE, MERCHANTABILITY OR FITNESS FOR PURPOSE. Microchip disclaims all liability arising from this information and its use. Use of Microchip's products as critical components in life support systems is not authorized except with express written approval by Microchip. No licenses are conveyed, implicitly or otherwise, under any Microchip intellectual property rights.

Trademarks

The Microchip name and logo, the Microchip logo, Accuron, dsPIC, KEELOQ, microID, MPLAB, PIC, PICmicro, PICSTART, PRO MATE, PowerSmart, rfPIC, and SmartShunt are registered trademarks of Microchip Technology Incorporated in the U.S.A. and other countries.

AmpLab, FilterLab, MXDEV, MXLAB, PICMASTER, SEEVAL, SmartSensor and The Embedded Control Solutions Company are registered trademarks of Microchip Technology Incorporated in the U.S.A.

Analog-for-the-Digital Age, Application Maestro, dsPICDEM, dsPICDEM.net, dsPICworks, ECAN, ECONOMONITOR, FanSense, FlexROM, fuzzyLAB, In-Circuit Serial Programming, ICSP, ICEPIC, Migratable Memory, MPASM, MPLIB, MPLINK, MPSIM, PICKit, PICDEM, PICDEM.net, PICLAB, PICtail, PowerCal, PowerInfo, PowerMate, PowerTool, rLAB, rfPICDEM, Select Mode, Smart Serial, SmartTel and Total Endurance are trademarks of Microchip Technology Incorporated in the U.S.A. and other countries.

SQTP is a service mark of Microchip Technology Incorporated in the U.S.A.

All other trademarks mentioned herein are property of their respective companies.

© 2004, Microchip Technology Incorporated, Printed in the U.S.A., All Rights Reserved.

 Printed on recycled paper.

QUALITY MANAGEMENT SYSTEM
CERTIFIED BY DNV
== ISO/TS 16949:2002 ==

Microchip received ISO/TS-16949:2002 quality system certification for its worldwide headquarters, design and wafer fabrication facilities in Chandler and Tempe, Arizona and Mountain View, California in October 2003. The Company's quality system processes and procedures are for its PICmicro® 8-bit MCUs, KEELOQ® code hopping devices, Serial EEPROMs, microperipherals, nonvolatile memory and analog products. In addition, Microchip's quality system for the design and manufacture of development systems is ISO 9001:2000 certified.



MCP215X DATA LOGGER DEMO BOARD USER'S GUIDE

Table of Contents

Preface	1
Chapter 1. Overview	7
1.1 Introduction	7
1.2 What is the MCP215X Data Logger Demo Board?	7
1.3 What the MCP215X Data Logger Demo Board Kit Includes	7
Chapter 2. Installation and Operation	9
2.1 Introduction	9
2.2 Features	10
2.3 Getting Started	11
2.4 Running the demos	23
2.5 MCP215X Data Logger Demo Board Description	39
Appendix A. Schematic and Layouts	45
A.1 Introduction	45
A.2 Schematics and PCB Layout	45
Appendix B. Bill-Of-Materials (BOM)	49
Appendix C. MCP215X Connection Sequence Overview	51
Appendix D. MCP215X 250-byte Data Transmit Table	53
Worldwide Sales and Service	54

MCP215X Data Logger Demo Board User's Guide

NOTES:



MCP215X DATA LOGGER DEMO BOARD USER'S GUIDE

Preface

NOTICE TO CUSTOMERS

All documentation becomes dated, and this manual is no exception. Microchip tools and documentation are constantly evolving to meet customer needs, so some actual dialogs and/or tool descriptions may differ from those in this document. Please refer to our web site (www.microchip.com) to obtain the latest documentation available.

Documents are identified with a "DS" number. This number is located on the bottom of each page, in front of the page number. The numbering convention for the DS number is "DSXXXXXA", where "XXXXX" is the document number and "A" is the revision level of the document.

For the most up-to-date information on development tools, see the MPLAB® IDE on-line help. Select the Help menu, and then Topics to open a list of available on-line help files.

INTRODUCTION

This chapter contains general information that will be useful to know before using the MCP215X Data Logger Demo Board User's Guide. Items discussed in this chapter include:

- About This Guide
- Recommended Reading
- The Microchip Web Site
- Customer Support

MCP215X Data Logger Demo Board User's Guide

ABOUT THIS GUIDE

Document Layout

This document describes how to use the MCP215X Data Logger Demo Board User's Guide as a development tool to emulate and debug firmware on a target board. The manual layout is as follows:

- **Chapter 1: Product Overview** – Important information about the MCP215X Data Logger Demo Board User's Guide.
- **Chapter 2: MCP215X Data Logger Demo Board User's Guide** – Includes instructions on how to get started with this demo board, with a detailed description of each function.
- **Appendix A: Schematic and Layouts** – Shows the schematic and layout diagrams for the MCP215X Data Logger Demo Board.
- **Appendix B: Bill-of-Materials** – Lists the parts used to build the MCP215X Data Logger Demo Board.
- **Appendix C: Connection Sequence** – Shows the connection sequence between a Primary device and the MCP215X (Secondary device). This connection sequence is shown at an overview level and does not show exact operation.
- **Appendix D: 250 Byte Transmit Table** – Shows the data that is transmitted by the program when in 250-Byte Transmit mode.

Conventions Used in this Guide

This manual uses the following documentation conventions:

DOCUMENTATION CONVENTIONS

Description	Represents	Examples
Arial font:		
Italic characters	Referenced books	<i>MPLAB[®] IDE User's Guide</i>
	Emphasized text	...is the <i>only</i> compiler...
Initial caps	A window	the Output window
	A dialog	the Settings dialog
	A menu selection	select Enable Programmer
Quotes	A field name in a window or dialog	"Save project before build"
Underlined, italic text with right angle bracket	A menu path	<u><i>File>Save</i></u>
Bold characters	A dialog button	Click OK
	A tab	Click the Power tab
'bnnnn	A binary number where <i>n</i> is a digit	'b00100, 'b10
Text in angle brackets < >	A key on the keyboard	Press <Enter>, <F1>
Courier font:		
Plain Courier	Sample source code	#define START
	Filenames	autoexec.bat
	File paths	c:\mcc18\h
	Keywords	_asm, _endasm, static
	Command-line options	-Opa+, -Opa-
	Bit values	0, 1
Italic Courier	A variable argument	<i>file.o</i> , where <i>file</i> can be any valid filename
0xnnnn	A hexadecimal number where <i>n</i> is a hexadecimal digit	0xFFFF, 0x007A
Square brackets []	Optional arguments	mcc18 [options] <i>file</i> [options]
Curly brackets and pipe character: { }	Choice of mutually exclusive arguments; an OR selection	errorlevel {0 1}
Ellipses...	Replaces repeated text	var_name [, var_name...]
	Represents code supplied by user	void main (void) { ... }

MCP215X Data Logger Demo Board User's Guide

RECOMMENDED READING

This user's guide describes how to use MCP215X Data Logger Demo Board User's Guide. Other useful documents are listed below. The following Microchip documents are available and recommended as supplemental reference resources.

MCP2150 Data Sheet (DS21790)

This data sheet provides detailed information regarding the MCP2150 device.

MCP2155 Data Sheet (DS21790)

This data sheet provides detailed information regarding the MCP2155 device.

AN858, "Interfacing the MCP215x to Host Controller" (DS00858)

This application note discusses the interface between a Host Controller and the MCP215X device.

AN888, "Programming the Palm OS® for Embedded IR Applications" (DS00888)

This application note discusses the programming of a Palm™ PDA to interface to an IrDA® standard device using IrCOMM.

AN926, "Programming the Pocket PC OS for Embedded IR Applications" (DS00926)

This application note discusses the programming of a Pocket PC PDA to interface to an IrDA standard device using IrCOMM.

AN941, "Programming Windows® XP for Embedded IR Applications" (DS00941)

This application note discusses the programming of a Windows XP PC to interface to an IrDA standard device using IrCOMM.

THE MICROCHIP WEB SITE

Microchip provides online support via our web site at www.microchip.com. This web site is used as a means to make files and information easily available to customers. Accessible by using your favorite Internet browser, the web site contains the following information:

- **Product Support** – Data sheets and errata, application notes and sample programs, design resources, user's guides and hardware support documents, latest software releases and archived software
- **General Technical Support** – Frequently Asked Questions (FAQ), technical support requests, online discussion groups, Microchip consultant program member listing
- **Business of Microchip** – Product selector and ordering guides, latest Microchip press releases, listing of seminars and events, listings of Microchip sales offices, distributors and factory representatives

CUSTOMER SUPPORT

Users of Microchip products can receive assistance through several channels:

- Distributor or Representative
- Local Sales Office
- Field Application Engineer (FAE)
- Technical Support
- Development Systems Information Line

Customers should contact their distributor, representative or field application engineer (FAE) for support. Local sales offices are also available to help customers. A listing of sales offices and locations is included in the back of this document.

Technical support is available through the web site at: <http://support.microchip.com>

In addition, there is a Development Systems Information Line which lists the latest versions of Microchip's development systems software products. This line also provides information on how customers can receive currently available upgrade kits.

The Development Systems Information Line numbers are:

1-800-755-2345 – United States and most of Canada

1-480-792-7302 – Other International Locations

MCP215X Data Logger Demo Board User's Guide

NOTES:

Chapter 1. Overview

1.1 INTRODUCTION

This chapter provides an overview of the MCP215X Data Logger Demo Board and covers the following topics:

- What is the MCP215X Data Logger Demo Board?
- What the MCP215X Data Logger Demo Board kit includes

1.2 WHAT IS THE MCP215X DATA LOGGER DEMO BOARD?

The MCP215X IrDA[®] Standard Protocol Stack Controller device allows the system designer to implement a low-cost, wireless IR port in any application providing support for the IrDA standard protocol stack and IrDA standard bit encoding/decoding.

The MCP215X Data Logger Demo Board is used to evaluate and demonstrate either the MCP2150 or MCP2155 device in a data-logging application. The board will communicate to a Primary device (such as a PDA (e.g., Palm™ or Pocket PC) or laptop computer). It is intended to serve as an example to assist system designers in developing an IrDA standard node using the MCP215X device.

Though the MCP215X Data Logger Demo Board ships with a MCP2150 installed, this device may be interchanged with a MCP2155, allowing the MCP2155 to be evaluated.

Note: If the MCP2150 is replaced by the MCP2155, the MCP2155 device must have the firmware programmed into the device. Ensure that the demo program firmware was assembled for the MCP2155 (the demo program uses conditional assembly to use the same source file for the two devices). The “MCP215X” variable needs to be equated to ‘55’. The MPASM™ assembler will display a message as to which device the file has assembled for.

1.3 WHAT THE MCP215X DATA LOGGER DEMO BOARD KIT INCLUDES

This MCP215X Data Logger Demo Board Kit includes:

- The MCP215X Data Logger Demo Board (with MCP2150 installed)
- MCP215X Data Logger Demo Board User's Guide (on CD-ROM)
- CD-ROM also includes:
 - Palm PDA Primary device application program (and related Application Note 888)
 - Pocket PC Primary device application program (and related Application Note 926)
 - Windows XP Primary device application program (and related Application Note 941)
 - Demo board firmware that can be conditionally assembled for either the MCP2150 or the MCP2155.

MCP215X Data Logger Demo Board User's Guide

NOTES:



MCP215X DATA LOGGER DEMO BOARD USER'S GUIDE

Chapter 2. Installation and Operation

2.1 INTRODUCTION

This chapter discusses the installation and operation of the MCP215X Data Logger Demo Board and a Primary device for data communication. This demonstrates an IrDA standard system and will assist the system designer on how to integrate an IR port into a system.

The MCP215X Data Logger Demo Board demonstrates the implementation of an embedded system with an IrDA standard interface. This system operates as an IrDA standard Secondary device using either the MCP2150 or the MCP2155 device.

The IrDA standard system requires the Primary device to be running an appropriate application program. The MCP215X Data Logger Demo Board interfaces to the Primary device application programs that are currently available from Microchip. The three application programs available for the following Primary device systems are:

- Palm OS®
- Microsoft® Pocket PC 2003
- Microsoft® Windows XP

These application programs are supported by three application notes that discuss the programming of these particular operating systems. These application notes are:

- AN888, "Programming the Palm OS® for Embedded IR Applications", DS00888
- AN926, "Programming the Pocket PC for Embedded IR Applications", DS00926
- AN941, "Programming Windows XP® for Embedded IR Applications", DS00941

Note: References to a MCP215X device in this document can refer to either the MCP2150 or the MCP2155 device.

The host UART interface includes non-data flow control signals. These are the signals between a Host Controller and a MCP215X device. A discussion of the host UART interface is given in the following application note:

- AN858, "Interfacing the MCP215X to a Host Controller", DS00858

2.2 FEATURES

The MCP215X Data Logger Demo Board has the following features:

- Communicates directly to Primary device (PDA or laptop computer) running the supplied Primary device application program or running a terminal emulation program
- LCD display (2 row x 16 character) for display of system information
- Data is transmitted in an easy-to-read format
- Reprogrammable PIC16F877 with MPLAB[®] In-Circuit Debugger (ICD) interface for user application development
- 18-pin socket for the installation of either a MCP2150 (default device) or a MCP2155 (optional device)
- Header that allows either several board signals to be monitored or allows the MCP215X Data Logger Demo Board to be interfaced to the user's system
- Eight LEDs that indicate MCP215X status (CTS, RTS, DTR, DSR, CD and RI activity)
- Eight LEDs that are connected to PORTD of the PIC16F877
- Battery-operated by a 9V source (can use a 9V battery)
- PICmicro[®] microcontroller (MCU) RESET switch
- Two switches (SW2 and SW3) to control the PICmicro MCU program operation
- Header and jumpers to allow the electrical removal of the optical transceiver and the installation of an alternate optical transceiver circuit (on a daughter board)
- Variable resistor connected to PICmicro MCU A/D input
- 8-pin DIP socket for the installation of an optional serial EEPROM (24LC256)

2.3 GETTING STARTED

This section presents an overview of the following system blocks:

- The MCP215X Data Logger Demo Board Hardware
- The MCP215X Data Logger Demo Board Firmware
- The Primary device Graphical User Interface (GUI)

This should give you an understanding of what these components do in the complete IrDA standard system.

2.3.1 The MCP215X Data Logger Demo Board Hardware Overview

The major components for the MCP215X Data Logger Demo Board are:

1. MCP215X device (U3)
2. Optical transceiver (U5 - TFDS 4500)
3. PICmicro MCU (U1 - PIC16F877)
4. LCD module
5. Power supply
6. User inputs to PICmicro MCU (SW2, SW3 and variable resistor (VR1))
7. PICmicro MCU RESET
8. PICmicro MCU crystal (Y2)

The MCP215X Data Logger Demo Board is fully assembled and tested for evaluation and demonstration of the MCP2150 or MCP2155 features. A block diagram of the demo board is shown in Figure 2-1. The board has been designed to allow the installation of an optional LCD contrast control (VR2) and serial EEPROM device. These optional components are removed from the MCP215X Data Logger Demo Board block diagrams for readability.

For more detailed circuit information, refer to **Appendix A. "Schematic and Layouts"** and **Appendix B. "Bill-Of-Materials (BOM)"**.

FIGURE 2-1: MCP215X DATA LOGGER DEMO BOARD BLOCK DIAGRAM

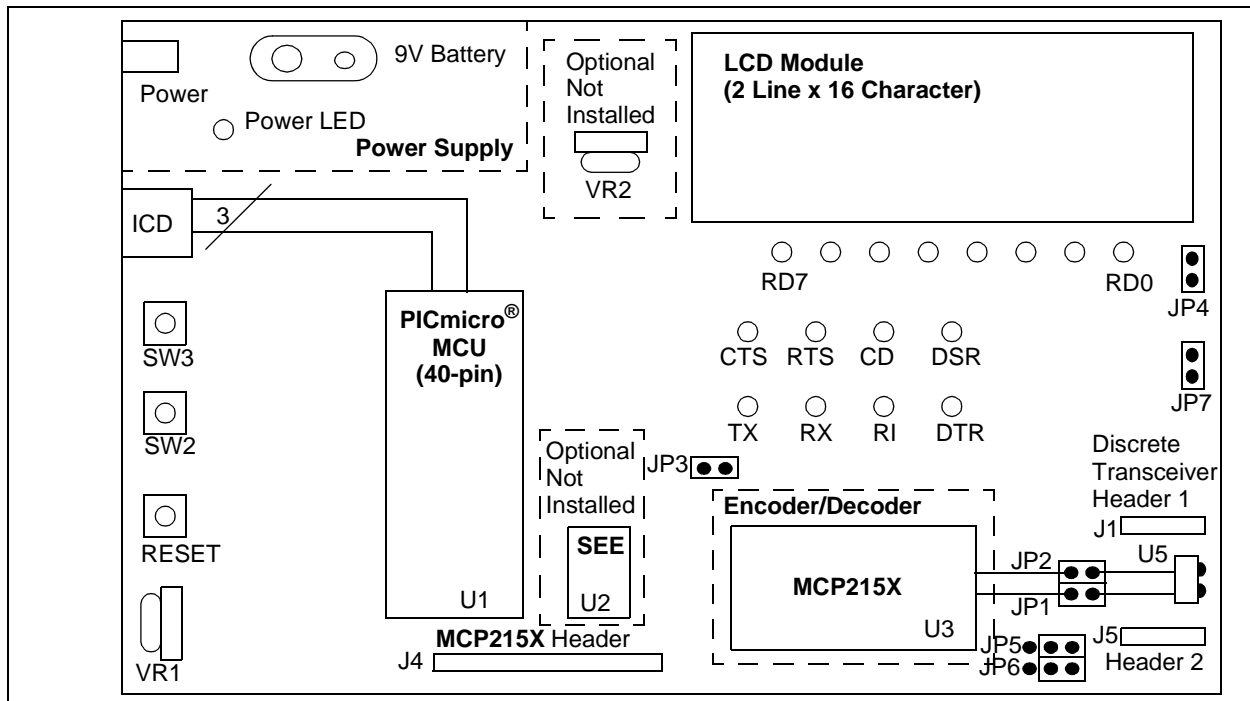

MCP215X Data Logger Demo Board User's Guide

Figure 2-2 shows the layout of the MCP215X Data Logger Demo Board with indication to points of interest.

FIGURE 2-2: MCP215X DATA LOGGER DEMO BOARD

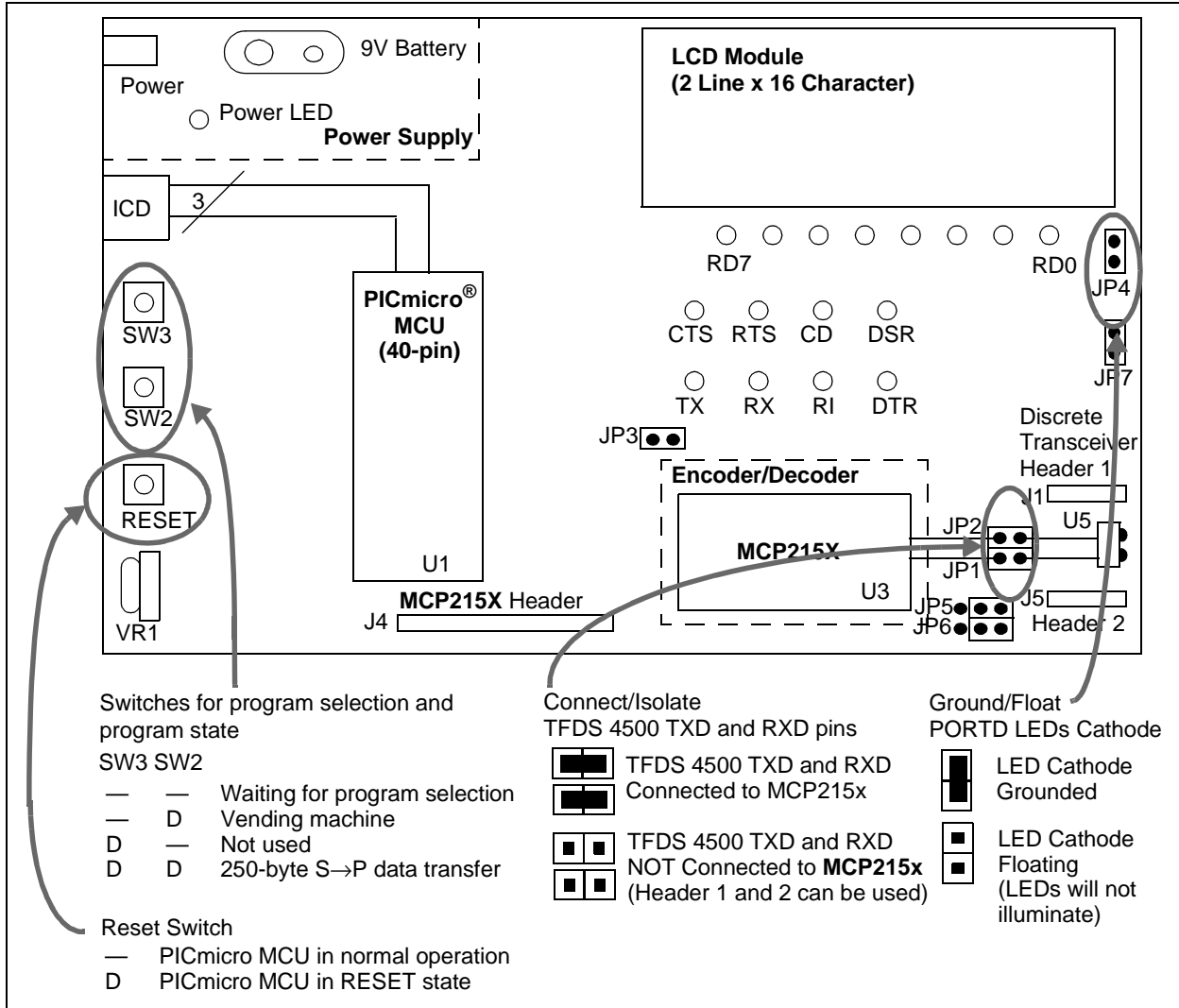
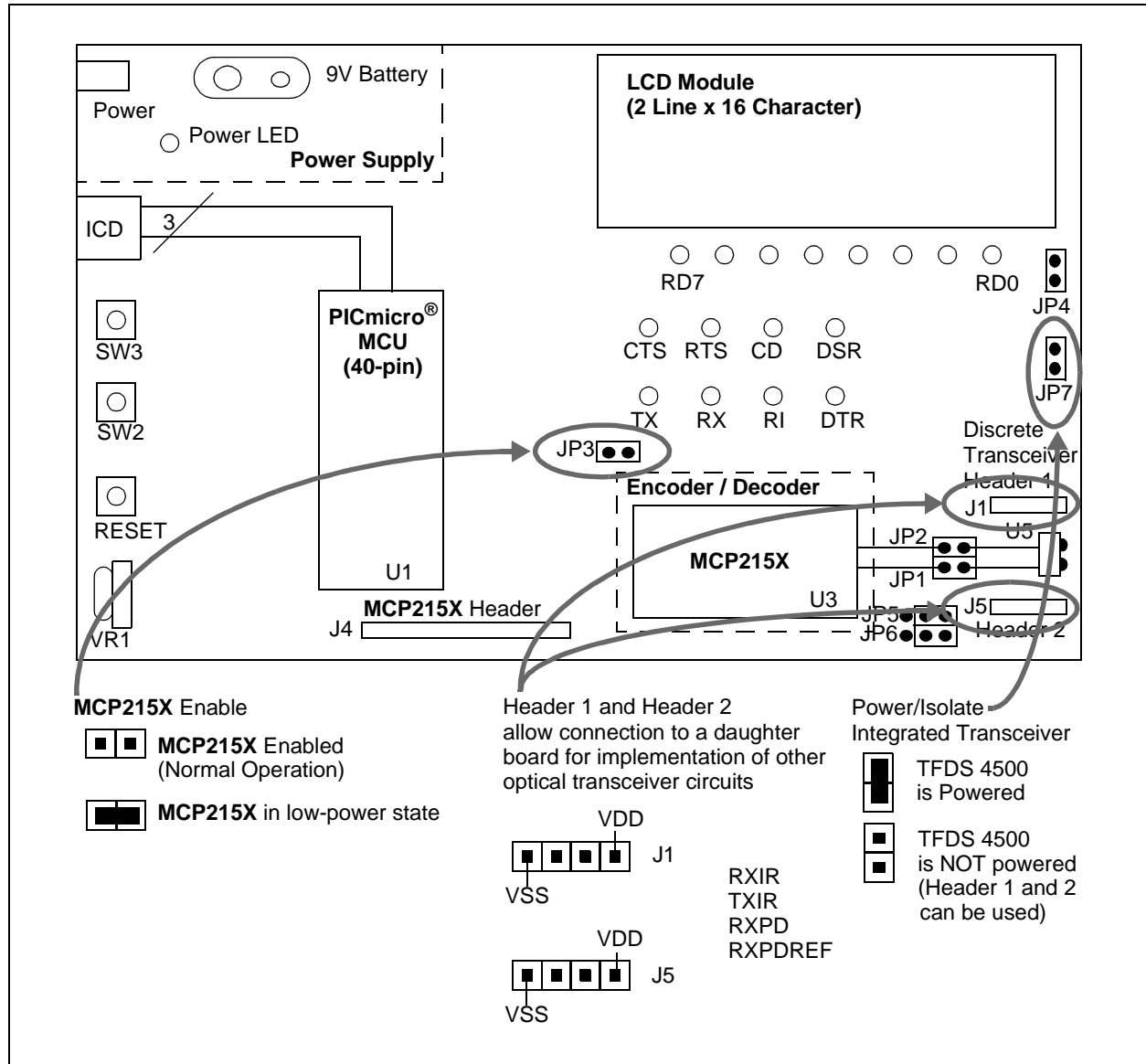

Figure 2-3 shows the switches used to reset the MCP2150 and select one of two demo programs. Switch **RESET** resets the MCP2150 and switch **S2** is used for program selection.

FIGURE 2-3: MCP215X DATA LOGGER DEMO BOARD



MCP215X Data Logger Demo Board User's Guide

FIGURE 2-4: MCP215X DATA LOGGER DEMO BOARD

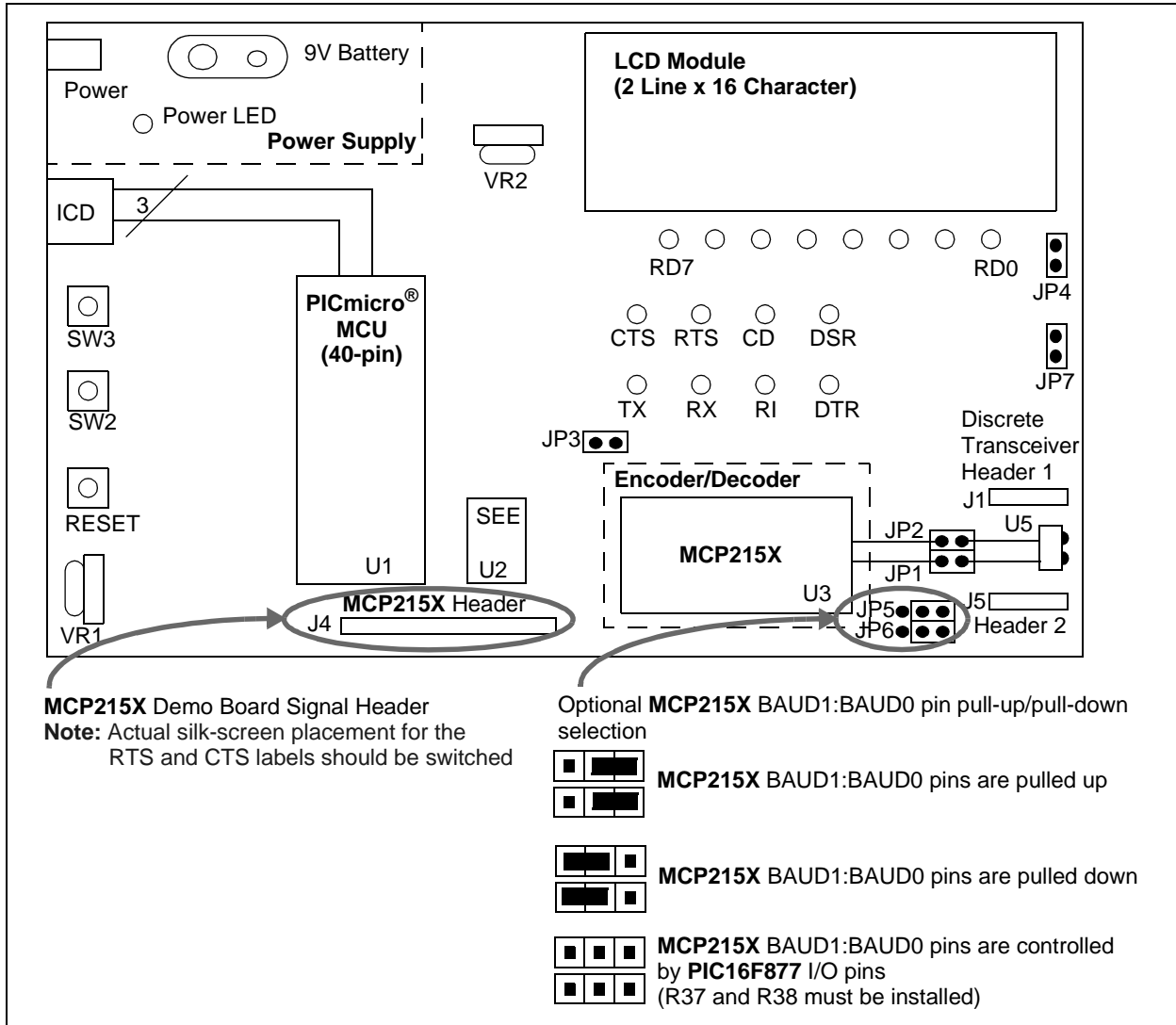

A description of the MCP215X Data Logger Demo Board jumpers is given in Table 2-1.

TABLE 2-1: JUMPER DESCRIPTIONS AND SETTINGS

Jumper #	Typical Settings ⁽¹⁾	Description	Comment
JP1	S	To connect TXIR of MCP2150 to TXD of U5 (TFDS 4500) S = TXIR connected to TXD O = TXIR Not connected to TXD	When Open, the signal can come from the daughter board connected to Header J1/J5.
JP2	S	To connect RXIR of MCP2150 to RXD of U5 (TFDS 4500) S = RXIR connected to RXD O = RXIR Not connected to RXD	When Open, the signal can come from the daughter board connected to Header J1/J5.
JP3	O	To connect EN of MCP2150 to Vss S = MCP2150 in Low-power mode O = MCP2150 during normal operation	
JP4	S	To connect cathode of LEDs (RD7:RD0) to Vss S = Cathode of LEDs to Vss O = Cathode of LEDs floating	The PCB default state is shorted between jumper. No jumper is required.
JP5	N/A	To control source of MCP2150 BAUD1 pin	
JP6	N/A	To control source of MCP2150 BAUD0 pin	
JP7	S	To connect VDD to integrated optical transceiver (U5) - TFDS 4500	

Legend: S = Jumper is shorted (Closed) O = Jumper is Open

Note 1: This is the jumper settings for using the integrated transceiver where the PIC16F877 controls the baud rate and the PORTD LEDs are used.

2.3.2 The Embedded System Firmware Overview

There are two PIC16F877 firmware programs that can be demonstrated on the demo board. These are:

- A vending machine that allows the uploading of data and responds to the commands of the Primary device
- A 250-byte secondary device (S) to primary device (P) data transfer. This demonstrates the S → P data throughput

The 250-byte Secondary device (S) to Primary device (P) data transfer program has two options. These are:

1. Transfer data from the Host Controller (PIC16F877) to the MCP2150 while the CTS signal is low.
2. Transfer 64 bytes of data from the Host Controller (PIC16F877) to the MCP2150 after CTS signal falling edge.

Option 2 will demonstrate higher S → P data throughput.

Typical Primary devices include Palm or Pocket PC PDAs and laptop PCs with an IrDA standard infrared port. The embedded system acts as an IrDA standard Secondary device.

The PIC16F877 firmware follows the flow control of the host UART interface. These are the signals between a Host Controller and a MCP2150 device.

The details of the vending machine firmware operation are discussed in **Section 2.3.2.1 “Vending Machine Program Description”**.

The details of the “250 byte Secondary Device (S) to Primary Device (P) Data Transfer” firmware operation are discussed in **Section 2.3.2.2 “250-byte Secondary Device (S) to Primary Device Data Transfer Program Description”**.

Figure 2-5 shows the program flow that occurs to select between these two programs. The MCP215X Data Logger Demo Board LCD module will display information on the state of the firmware execution. This information includes queries for user input.

The selection of the program is dependant on the switches (SW2 and SW3) that are depressed (see Figure 2-4).

TABLE 2-2: DEMO PROGRAM SELECTION

SW3	SW2	Demo Program
—	—	N/A (waiting for a switch to be depressed)
—	D	Vending machine
D	—	Not implemented
D	D	S→P Transfer 250-bytes from demo board to Primary device (PDA)

Note: D = Depressed — = Not depressed

The MCP2150/MCP2155 source code of the MCP215X Data Logger Demo Board is available for download from the Microchip web site at www.microchip.com. This board also supports the MCP2155 device with only a change of the PIC16F877 firmware. The MCP2140 can be supported with some hardware modifications and changes to the PIC16F877 firmware.

FIGURE 2-5: PIC16F877 FIRMWARE FLOW - MAIN

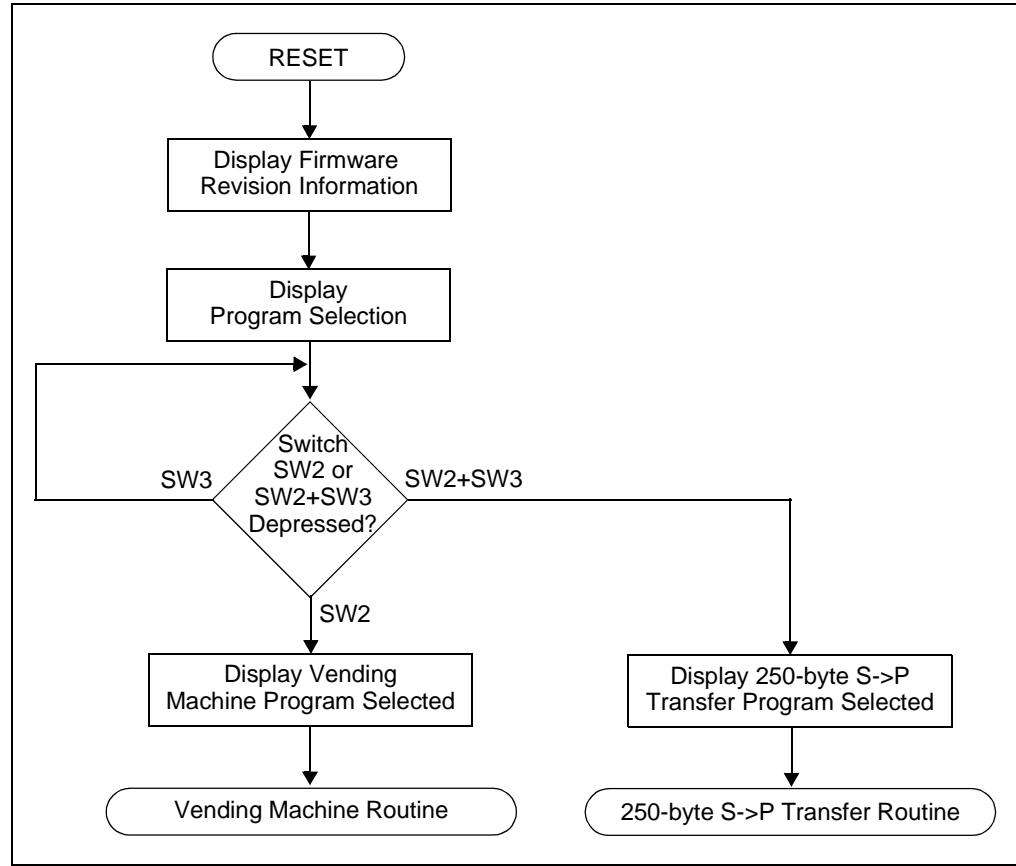

2.3.2.1 VENDING MACHINE PROGRAM DESCRIPTION

This demo emulates a vending machine by counting the number of each item (soda and candy) dispensed.

Once the MCP215X Data Logger Demo Board has completed reset and the LCD module indicates which switches to depress to select a program, depress switch **S2**. The LCD module will indicate that the vending machine program is selected.

The LCD module will then indicate the values of the soda and candy counters. Depressing the **S2** switch will increment the soda counter, while depressing the **S3** switch will increment the candy counter. Once either switch is depressed, the LCD module displays the new counter values. Each counter is an 8-bit value and can display a value from 0 to 255 (decimal).

When the PIC16F877 receives a data byte, the value is checked to determine the operation to perform. The vending machine program understands two commands:

1. Transmit the counter values.
2. Clear the counter values.

Table 2-3 shows the two commands that the vending machine program accepts. All other data values that are received are ignored. Once the program has received the "Transmit the current counter values" command, the PIC16F877 will transmit the data on two lines, in the following easy-to-read format:

```
Soda = xxx  
Candy = xxx
```

where xxx is the counter value

TABLE 2-3: VENDING MACHINE COMMANDS

Description	Command	
	ASCII Code	Hex Code
Transmit the current soda and candy counter values to the Primary device	5	0x35
Clear the current soda and candy counters	6	0x36

Note: All other received data values are ignored.

The host UART interface is operating at 115,200 baud.

The transfer will not commence until the PIC16F877 has received a data byte from the Primary device.

The PIC16F877 follows the flow control of the MCP2150 to ensure that data is not lost. The MCP2150 handles all the IrCOMM protocol for the data packets that it receives from the PIC16F877.

Once the command has been processed, the PIC16F877 waits for the next command to be received.

The program flow for the vending machine demo is shown in Figure 2-6.

FIGURE 2-6: PIC16F877 FIRMWARE FLOW - VENDING MACHINE

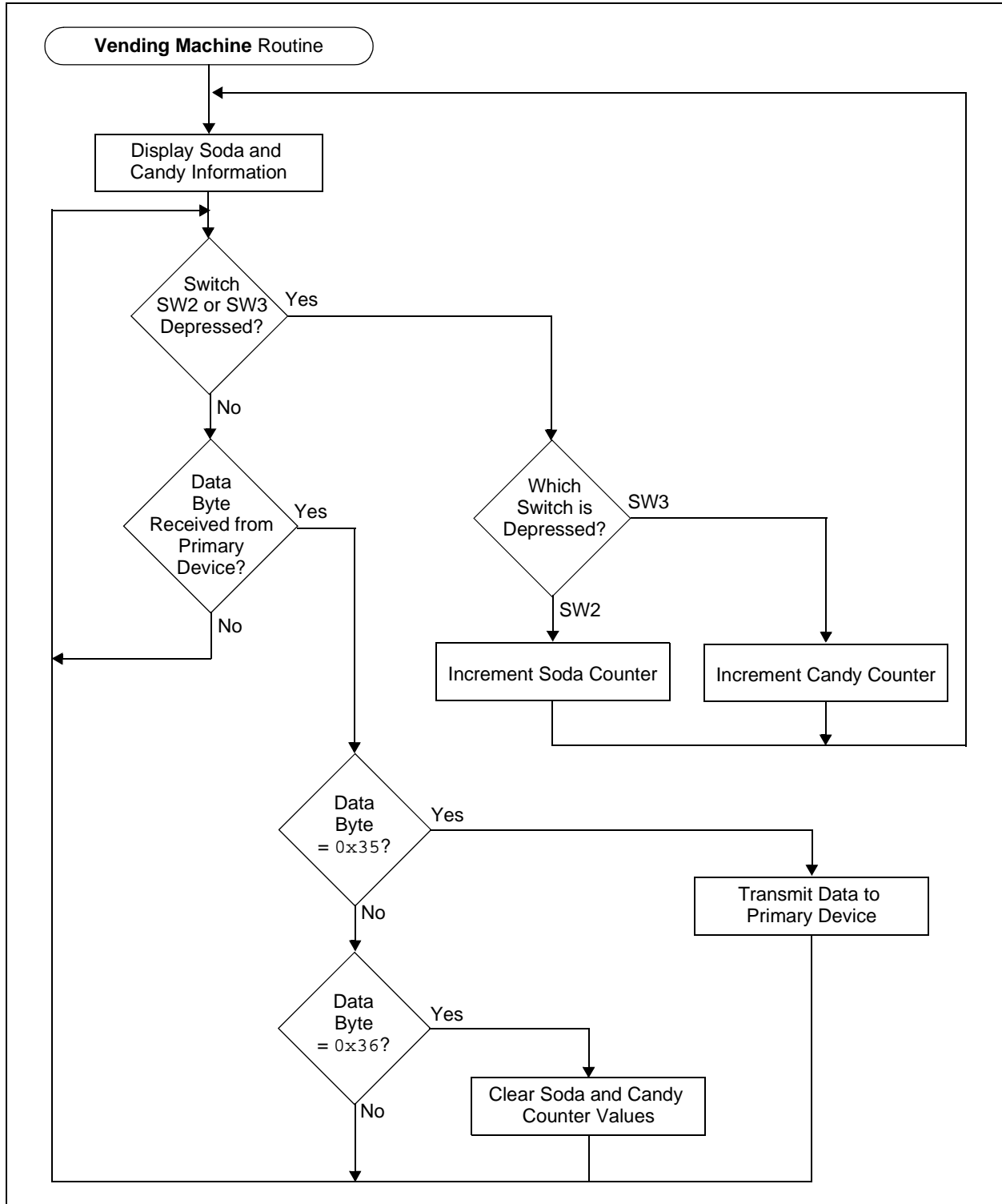

2.3.2.2 250-BYTE SECONDARY DEVICE (S) TO PRIMARY DEVICE DATA TRANSFER PROGRAM DESCRIPTION

After the MCP215X Data Logger Demo Board has completed reset and the LCD module indicates which switches to depress to select a program, depress switches **S2** and **S3** simultaneously. The LCD module will indicate that the 250-byte S→P program is selected.

You then need to specify the data transfer method. The host UART interface is operating at 115,200 baud. There are two methods by which to accomplish this.

In the first method, the PIC16F877 will transfer data to the MCP2150 while the CTS signal is low. This is the easiest method to implement. To select this method, depress switch **S2**. After depressing **S2**, the LCD will indicate the mode of data transfer and that it is waiting. The transfer will not commence until the PIC16F877 has received a data byte from the Primary device.

In the second method, the PIC16F877 will transfer 64 bytes of the data table to the MCP2150 after the falling edge of the CTS signal. This method gives the best data throughput. To select this method, depress switch **S3**. After depressing **S3**, the LCD will indicate the mode of data transfer and that it is waiting. The transfer will not commence until the PIC16F877 has received a data byte from the Primary device.

The PIC16F877 follows the flow control of the MCP2150 to ensure that data is not lost. The MCP2150 handles all the IrCOMM protocol for the data packets that it receives from the PIC16F877.

After the table has completed transmission, the PIC16F877 returns to the routine that asks for the data transfer method.

The program flow for the "250 Byte Secondary Device (S) to Primary Device (P) Data Transfer" demo is shown in Figure 2-7.

The 250-byte data table transmitted from the MCP215X Data Logger Demo Board to the Primary device is shown in **Appendix D. "MCP215X 250-Byte Data Transmit Table"**. These values will be displayed in the Primary device's terminal emulation program window.

<p>Note: The byte sent by the Primary device is expected since most PDAs will not establish a link until data is sent. Depending on the PDA application program used (Palm™ or Pocket PC), the operation of the Connect button varies.</p>
--

The PIC16F877 receives a single byte from the IrDA standard Primary device and then a 250-byte table is transmitted back to the Primary device.

If you desire more than 250 bytes to be transferred, the source code is written to allow this 250-byte table to be transmitted multiple times. At the beginning of the S→P Data Transfer routine (routine has label `S2Pxfcr`), there is a `#define` for the `TableCNTR`. This is set to '1', but can be changed to allow the data table to be transmitted "`TableCNTR`" time. `TableCNTR` should not be greater than D'255' (8-bit value)

FIGURE 2-7: PIC16F877 FIRMWARE FLOW - 250-BYTE S->P TRANSFER

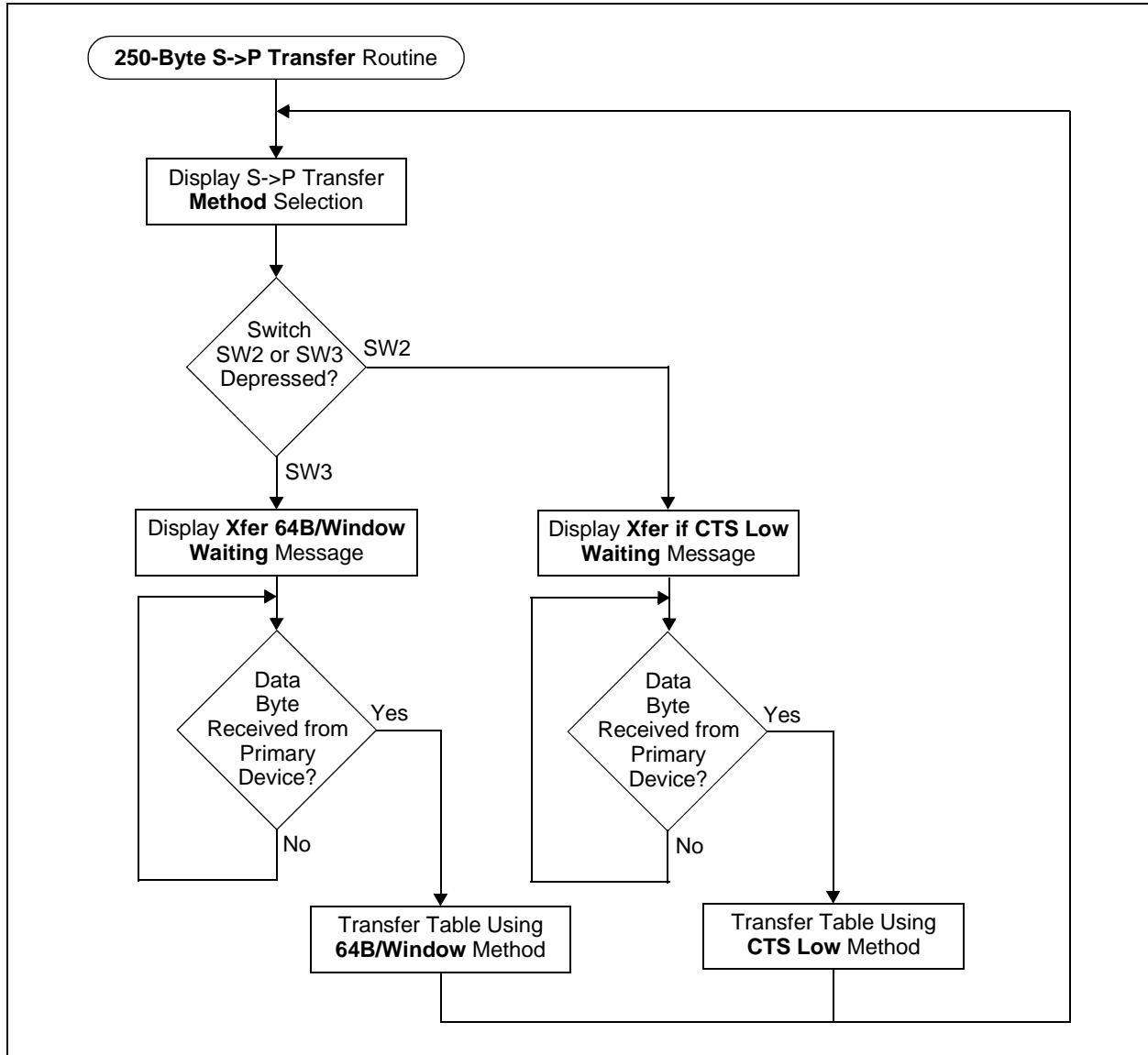

2.3.3 The Primary Device Graphical User Interface (GUI) Overview

Three Primary device platforms have had application programs developed to interface to the MCP215X Data Logger Demo Board. These platforms are:

- Palm PDAs
- Pocket PC PDAs
- Window XP PCs

The GUI for these three platforms have been designed to look similar. Figure 2-8 shows the GUIs for the three platforms. A more detailed description of each GUI is given in the section that describes how to use that Primary device with the MCP215X Data Logger Demo Board (**Section 2.4.1 “Running the MCP215X Data Logger Demo Board with a Palm PDA”, Section 2.4.2 “Running the MCP215X Data Logger Demo Board with a Pocket PC PDA” or Section 2.4.3 “Running the MCP215X Data Logger Demo Board with a Window XP PC with an IrDA Standard Port”**).

FIGURE 2-8: PRIMARY DEVICE GUIS

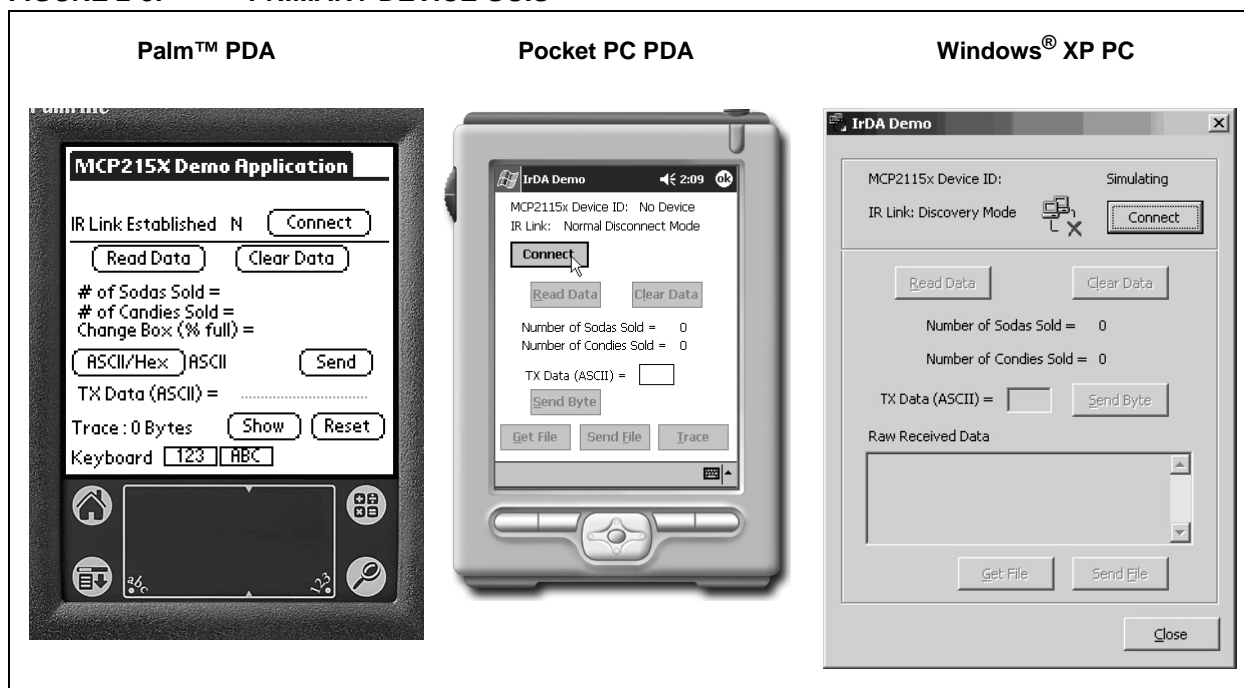

2.4 RUNNING THE DEMOS

This demo board can interface to any Primary device that implements the IrCOMM 9-wire “cooked” protocol layer. Some typical Primary devices include:

1. Palm PDA
2. Pocket PC PDA
3. Laptop PC with IrDA Standard Port

Three application programs have been developed to interface these devices to the MCP215X Data Logger Demo Board. One for each Primary device platform shown. These application programs also have an associated application note to discuss the implementation of the application program. These programs are discussed in the following application notes:

- For Palm OS - Application Note 888, *“Programming the Palm OS® for Embedded IR Applications”*, DS00888
- For Pocket PC OS - Application Note 926, *“Programming the Pocket PC OS for Embedded IR Applications”*, DS00926
- For Windows XP - Application Note 941, *“Programming Windows® XP for Embedded IR Applications”*, DS00941

Other third-party programs may be used to communicate with the MCP215X Data Logger Demo Board, though these methods will not be discussed in this document. If additional information is desired, refer to the MCP2140 IrDA® Standard Wireless Temperature Sensor Demo Board User’s Guide (DS51487).

2.4.1 Running the MCP215X Data Logger Demo Board with a Palm PDA

An overview of the Application Note 941 GUI is given (Section 2.4.1.1 “The Palm PDA GUI”), followed by the operation of the demos (Section 2.4.3.2 “Running The Demos Using The Application Note 941 Program”).

2.4.1.1 THE PALM PDA GUI

The GUI consists of a number of user-interface elements, including command buttons, text labels and a text-entry field. Refer to Figure 2-9.

FIGURE 2-9: PALM PDA MAIN FORM

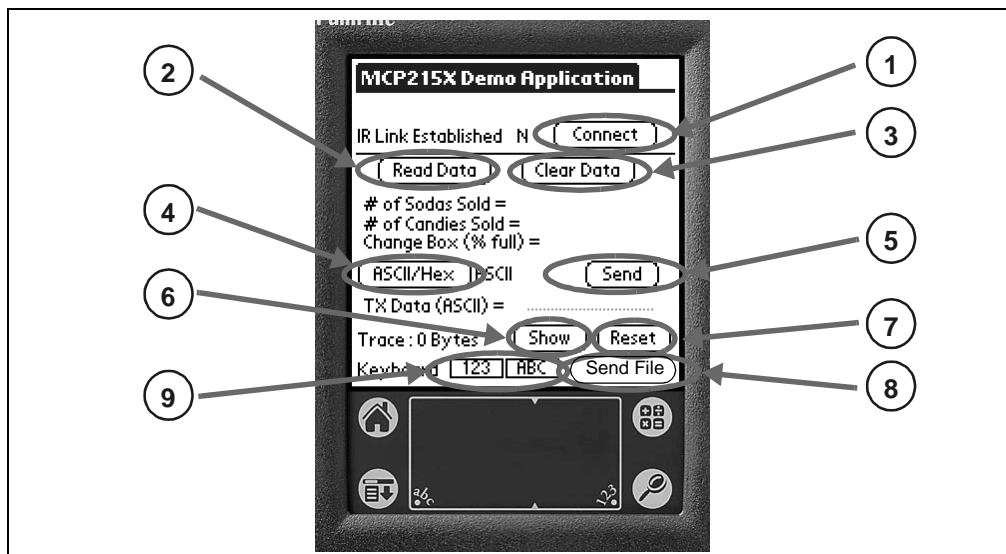

1. The **Connect** button attempts to establish a connection to the MCP215X Data Logger Demo Board, with the Palm PDA acting as the Primary device. The label to the left of the button provides an indication of the connection.
2. The **Read Data** button sends a query to the demo board, requesting the soda and candy counter values. Received data is parsed and displayed.
3. The **Clear Data** button sends a command to the demo board, instructing it to reset the application level counters. The command to “Read Data” is then sent to ensure that the registers were cleared.
4. The **ASCII/HEX** button toggles the application between ASCII and HEX modes. This value is used when preparing and transmitting data to the IR demo board. This is useful when there is a need to send a non-printable value, such as low-order ASCII. For example, to send the value 0x03, use the keyboard or Graffiti® to enter “03” (without the quotes). This will be converted to 0x03 and transmitted.
5. The **Send** button sends the data shown on the “TX Data” line. If HEX mode is selected, minimal error-checking is performed.
6. The **Show** button causes a message box to be displayed that contains the received buffer information.
7. The **Reset** button clears the Palm PDA application's receive data buffer.
8. The **Send File** button is used to send a file.
9. The **123** and **ABC** button opens a keyboard for data entry. The **123** button will open the numeric keyboard, while the **ABC** button will open the alpha keyboard.

2.4.1.2 RUNNING THE DEMO USING THE APPLICATION NOTE AN888 PROGRAM

After saving the AN888 application program to your PC's hard drive, the PC can communicate with the MCP215X Data Logger Demo Board. **Section 2.4.1.2.1 "Steps to Operate the Vending Machine Demo"** discusses how to operate the vending machine program, while **Section 2.4.1.2.2 "Steps to Operate the 250-byte S -> P Data Transfer Demo"** discusses how to operate the 250-byte Secondary device (S) to Primary device (P) data transfer program.

2.4.1.2.1 Steps to Operate the Vending Machine Demo

The vending machine demo is shown by following the steps in Table 2-4.

TABLE 2-4: VENDING MACHINE DEMO - PALM™ PDA

Step	Action	Result
1	Place both devices on a flat surface about 25 cm (10") apart, and with the IR ports facing each other	—
2	On the MCP215X Data Logger Demo Board: Ensure that jumpers JP1 and JP2 are shorted (closed position).	—
3	On the MCP215X Data Logger Demo Board: Ensure that jumper JP7 is shorted (closed position).	—
4	On the MCP215X Data Logger Demo Board: Insert the 9V battery into the battery holder (BT1) or plug a 9V AC to DC power supply (such as those supplied with some Microchip development tools) into the 9V DC connection plug (J2). You may need to depress the RESET switch if the LCD does not display the Microchip program revision information and then the directions for demo program selection.	On the MCP215X Data Logger Demo Board: The green power LED (D10) will turn on, the DTR LED will be on, while all the other UART flow control signals (CTS, RTS, CD, RI and DSR) will be off. Also, the RD7 and RD6 LEDs will be on.
5	On the MCP215X Data Logger Demo Board: Depress Switch 2 (SW2).	On the MCP215X Data Logger Demo Board: This causes the vending machine program to be executed.
6	On the PDA: Tap on the MCP215XDemo icon.	On the PDA: The screen will display the MCP215XDemo program window.
7	On the PDA: Tap on the Connect button.	On the PDA: The Connect button will change to the Disconnect button.
8	On the MCP215X Data Logger Demo Board: Switch 2 (SW2) increments the soda counter, and Switch 3 (SW3) increments the candy counter. The value of the candy and soda counters will be displayed on the LCD. Depress Switch 2 until the soda counter displays 7 and depress Switch 3 until the candy counter displays 12. For demonstration purposes, it is nice when the two counter values are different.	—

MCP215X Data Logger Demo Board User's Guide

TABLE 2-4: VENDING MACHINE DEMO - PALM™ (CONTINUED)PDA

Step	Action	Result
9	On the PDA: Tap on the Read Data button.	On the MCP215X Data Logger Demo Board: The CD LED will turn on. The CTS LED will strobe rapidly and then return to the normal rate.
		On the PDA: The Program window will update the display for "Number of Sodas Sold =" and "Number of Candies Sold =" to the value displayed on the demo board LCD.
10	On the MCP215X Data Logger Demo Board: Update the soda and candy counters by depressing Switch 2 until the soda counter displays 14 and depressing Switch 3 until the candy counter displays 16.	—
11	On the PDA: Tap on the Read Data button.	On the MCP215X Data Logger Demo Board: The CTS LED will strobe rapidly and then return to the normal rate.
		On the PDA: The program window will update the display for "Number of Sodas Sold =" and "Number of Candies Sold =" to the new value displayed on the demo board LCD.
12	On the PDA: Tap on the Clear Data button.	On the PDA: The program window will open a query window that asks "Clear Counters, Are You Sure".
13	On the PDA: In the Query box, tap the Yes button.	On the MCP215X Data Logger Demo Board: The LCD module will update the candy and soda counter values to 0.
		On the PDA: The program sends the command value to clear the counters. About a second later, the PDA sends a second command to read the counter values (which are now 0). The window will update the display for "Number of Sodas Sold =" and "Number of Candies Sold =" to the new value displayed on the demo board LCD.
14	Step 10 through Step 13 may be repeated.	—
15	On the PDA: Tap on the Disconnect button.	On the PDA: This will disconnect (close) the IR link. The Connect button will change to the Disconnect button.
		On the MCP215X Data Logger Demo Board: The CD and the CTS LEDs will turn off.

2.4.1.2.2 Steps to Operate the 250-byte S -> P Data Transfer Demo

The 250-byte S -> P data transfer demo is shown by following the steps in Table 2-5.

TABLE 2-5: 250-BYTE S -> P DATA TRANSFER DEMO - PALM™ PDA

Step	Action	Result
1	Place both devices on a flat surface about 25 cm (10") apart, with the IR ports facing each other.	—
2	On the MCP215X Data Logger Demo Board: Ensure that jumpers JP1 and JP2 are shorted (closed position).	—
3	On the MCP215X Data Logger Demo Board: Ensure that jumper JP7 is shorted (closed position).	—
4	On the MCP215X Data Logger Demo Board: Insert the 9V battery into the battery holder (BT1) or plug a 9V AC-to-DC power supply (such as those supplied with some Microchip development tools) into the 9V DC connection plug (J2). You may need to depress the RESET switch if the LCD does not display the Microchip program revision information, followed by the directions for demo program selection.	On the MCP215X Data Logger Demo Board: The green power LED (D10) will turn on, the DTR LED will be on, while all the other UART flow control signals (CTS, RTS, CD, RI and DSR) will be off. The RD7 and RD6 LEDs will also be on.
5	On the MCP215X Data Logger Demo Board: Depress Switch 2 and Switch 3 (SW2 + SW3) simultaneously.	On the MCP215X Data Logger Demo Board: This causes the 250-byte S->P data transfer program to be executed. The LCD will display that this program was selected and then update the display to show the two options for transmitting data from the PIC16F877 to the MCP2150: 1. CTS (transmit data bytes while CTS is low) 2. 64 bytes (transmit 64 data bytes when CTS goes low)
6	On the PDA: Tap on the MCP215XDemo icon.	On the PDA: The screen will display the MCP215XDemo program window.
7	On the PDA: Tap on the Connect button.	On the PDA: The Connect button will change to the Disconnect button.
8	On the PDA: Tap on the 123 button.	On the PDA: This opens the numeric keyboard.
9	On the PDA: Tap on the number (5) button.	On the PDA: In the upper-left corner of the window, the typed number will appear.
10	On the PDA: Tap on the Done button.	On the PDA: This closes the numeric keyboard window. The number that was typed is shown on the "TX Data (ASCII) =" line.

MCP215X Data Logger Demo Board User's Guide

TABLE 2-5: 250-BYTE S -> P DATA TRANSFER DEMO - PALM™ (CONTINUED)PDA

Step	Action	Result
11	On the MCP215X Data Logger Demo Board: Depress Switch 2 or Switch 3 to select which flavor of the transmit program is executed.	On the MCP215X Data Logger Demo Board: If SW2 is depressed, the Host Controller will only transmit data to the MCP2150 while the CTS signal is low. The LCD will indicate that the MCP215X Data Logger Demo Board is waiting to receive a data byte from the Primary device. If SW3 is depressed, the Host Controller will transmit 64 bytes of data to the MCP2150 when the CTS signal goes low. The LCD will indicate that the MCP215X Data Logger Demo Board is waiting to receive a data byte from the Primary device.
12	On the PDA: Tap on the Send Byte button.	On the MCP215X Data Logger Demo Board: The CD LED will turn on (the IR link is now open) and the CTS LED will strobe rapidly before returning to the normal rate. The second line of the LCD will display the text "Transmitting" and, once the data table has been sent, the text will change to "TX Complete". After approx. 1 second, the PIC16F877 will return to the routine used to select how the 250-byte table is transmitted (see Step 11). The LCD will display the options. On the PDA: Trace will show "250 bytes".
13	On the PDA: Tap on the Show button.	On the PDA: This opens the trace buffer window. The received data table should be in the window.
14	On the PDA: Tap on the OK button.	On the PDA: This closes the trace buffer window.
15	On the PDA: Tap on the Reset button.	On the PDA: This will open a query window that asks "Reset Trace Buffer, Are You Sure".
16	On the PDA: In the Query window, tap on the Yes button.	On the PDA: This clears the contents of the trace buffer. Trace shows "0 Bytes".
17	Step 8 through Step 16 may be repeated.	—
18	On the PDA: Tap on the Disconnect button.	On the PDA: This will disconnect (close) the IR link. When the IR link is disconnected, the PC icon will change to indicate that the IR link is disconnected (has a red X). On the MCP215X Data Logger Demo Board: The CD and the CTS LEDs will turn off.

2.4.2 Running the MCP215X Data Logger Demo Board with a Pocket PC PDA

An overview of the Application Note 941 GUI is given (Section 2.4.2.1 “The Pocket PC PDA GUI”) and then the operation of the demos is given (2.4.2.2 “Running The Demo Using The Application Note 926 Program”).

2.4.2.1 THE POCKET PC PDA GUI

The GUI consists of a number of user interface elements including command buttons, text labels and a text-entry field. (Figure 2-10)

FIGURE 2-10: POCKET PC PDA WINDOW

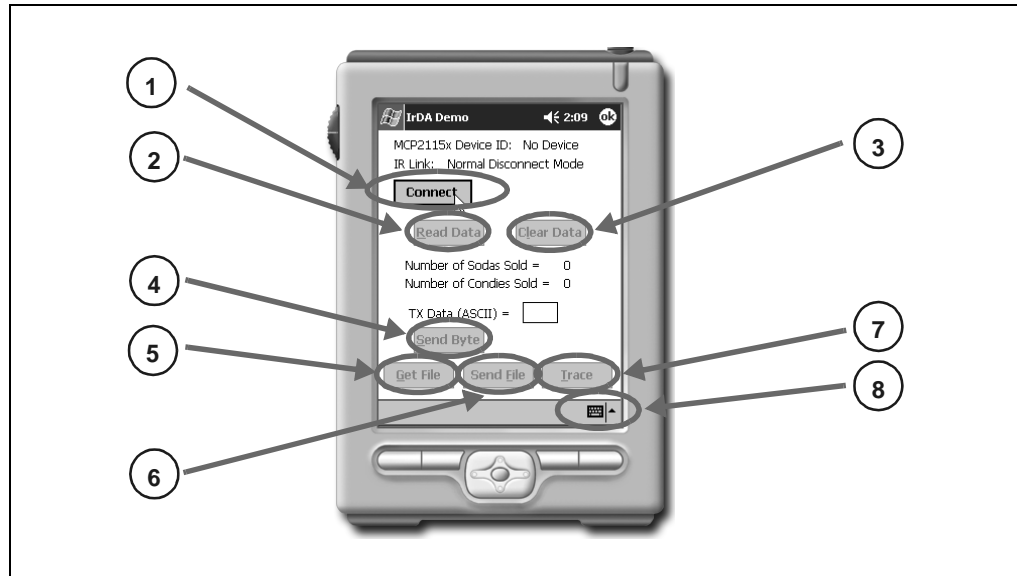

1. The **Connect** button attempts to establish a connection to the IR demo board. The PPC device is acting as the Primary device and the demo board as the Secondary device.
2. The **Read Data** button causes a query to be sent to the demo board, requesting the number of sodas and candies information. Data received from the demo board is parsed and displayed in text labels.
3. The **Clear Data** button sends a command to the demo board instructing it to reset the application level counters.
4. The **Send Byte** button transfers the byte entered into the TX Data (ASCII) text box. Any byte may be entered and transferred to the embedded system. If the byte corresponds to one of the commands to read data, clear data or transfer a buffer, the board will respond depending on its mode (vending machine or 250-byte transfer).
5. The **Get File** button initiates the 250-byte data transfer from the embedded system by sending the embedded system the command byte for the transfer.
6. The **Send File** button allows the user to select a file on the PPC and transfer it to the embedded system.
7. The **Trace** button causes the information in the trace buffer to be displayed. Within this window is the capability to clear the trace buffer.
8. The **Keyboard** button opens a keyboard for data entry. The **123** button will open the numeric keyboard, while the **ABC** button will open the alpha keyboard.

MCP215X Data Logger Demo Board User's Guide

2.4.2.2 RUNNING THE DEMO USING THE APPLICATION NOTE 926 PROGRAM

After saving the AN941 application program to your PC's hard drive, the PC can communicate with the MCP215X Data Logger Demo Board. **Section 2.4.2.2.1 "Steps to Operate the Vending Machine Demo"** discusses how to operate the vending machine program, while **2.4.2.2.2 "Steps to Operate the 250-byte S -> P Data Transfer Demo"** discusses how to operate the 250-byte Secondary device (S) to Primary device (P) data transfer program.

2.4.2.2.1 Steps to Operate the Vending Machine Demo

The vending machine demo is shown by following the steps in Table 2-6.

TABLE 2-6: VENDING MACHINE DEMO - POCKET PC

Step	Action	Result
1	Place both devices on a flat surface about 25 cm (10") apart and with the IR ports facing each other.	—
2	On the MCP215X Data Logger Demo Board: Ensure that jumpers JP1 and JP2 are shorted (closed position).	—
3	On the MCP215X Data Logger Demo Board: Ensure that jumper JP7 is shorted (closed position).	—
4	On the MCP215X Data Logger Demo Board: Insert the 9V battery into the battery holder (BT1) or plug a 9V AC-to-DC power supply (such as those supplied with some Microchip development tools) into the 9V DC Connection Plug (J2). You may need to depress the RESET switch if the LCD does not display the Microchip program revision information and then the directions for demo program selection.	On the MCP215X Data Logger Demo Board: The green power LED (D10) will turn on, the DTR LED will be on, while all the other UART Flow Control signals (CTS, RTS, CD, RI and DSR) will be off. Also the RD7 and RD6 LEDs will be on.
5	On the MCP215X Data Logger Demo Board: Depress Switch 2 (SW2).	On the MCP215X Data Logger Demo Board: This causes the vending machine program to be executed.
6	On the PDA: Start the IrDA® Demo program.	On the PDA: The screen will display the IrDA Demo program window, with the "Device ID" line displaying "Generic IrDA", while the "IR Link" line displays "Discovery Mode".
7	On the PDA: Tap on the Connect button.	On the PDA: Once the connection is made, the program window will be updated so that the Connect button is called the Disconnect button and the "IR Link" line displays "Normal Response Mode". On the MCP215X Data Logger Demo Board: The CD LED will turn on and the CTS LED will strobe rapidly and then return to the normal rate. This indicates that an IR link is established between the PDA and the demo board.

TABLE 2-6: VENDING MACHINE DEMO - POCKET PC (CONTINUED)

Step	Action	Result
8	<p>On the MCP215X Data Logger Demo Board: Switch 2 (SW2) increments the soda counter, and Switch 3 (SW3) increments the candy counter. The value of the candy and soda counters will be displayed on the LCD. Depress Switch 2 until the soda counter displays 7 and depress Switch 3 until the candy counter displays 12. For demonstration purposes, it is nice when the two counter values are different.</p>	—
9	<p>On the PDA: Tap on the Read Data button.</p>	<p>On the MCP215X Data Logger Demo Board: The CTS LED will strobe rapidly and then return to the normal rate.</p> <p>On the PDA: The program window will update the display for “Number of Sodas Sold =” and “Number of Candies Sold =” to the value displayed on the demo board LCD.</p>
10	<p>On the MCP215X Data Logger Demo Board: Update the soda and candy counters by depressing Switch 2 until the soda counter displays 14 and depressing Switch 3 until the candy counter displays 16.</p>	—
11	<p>On the PDA: Tap on the Read Data button.</p>	<p>On the MCP215X Data Logger Demo Board: The CTS LED will strobe rapidly and then return to the normal rate.</p> <p>On the PDA: The program window will update the display for “Number of Sodas Sold =” and “Number of Candies Sold =” to the new value displayed on the demo board LCD.</p>
12	<p>On the PDA: Tap on the Clear Data button.</p>	<p>On the MCP215X Data Logger Demo Board: The LCD module will update the candy and soda counter values to 0.</p>
13	<p>On the PDA: Tap on the Read Data button.</p>	<p>On the MCP215X Data Logger Demo Board: The CTS LED will strobe rapidly and then return to the normal rate.</p> <p>On the PDA: The Program window will update the display for “Number of Sodas Sold =” and “Number of Candies Sold =” to the value displayed on the demo board LCD.</p>
14	Step 10 through Step 13 may be repeated.	—
15	<p>On the PDA: Tap on the Disconnect button.</p>	<p>On the PDA: This will disconnect (close) the IR link. When the IR link is closed, the program window will be updated so that the Disconnect button changes back to the Connect button. The “IR Link” line will display “Normal Disconnect Mode” and then, after a couple of seconds, will display “Discovery Mode”.</p> <p>On the MCP215X Data Logger Demo Board: The CD and the CTS LEDs will turn off.</p>

MCP215X Data Logger Demo Board User's Guide

2.4.2.2.2 Steps to Operate the 250-byte S -> P Data Transfer Demo

The 250-byte S -> P data transfer demo is shown by following the steps in Table 2-7.

TABLE 2-7: 250-BYTE S -> P DATA TRANSFER DEMO - POCKET PC

Step	Action	Result
1	Place both devices on a flat surface about 25 cm (10") apart and with the IR ports facing each other.	—
2	On the MCP215X Data Logger Demo Board: Ensure that jumpers JP1 and JP2 are shorted (closed position).	—
3	On the MCP215X Data Logger Demo Board: Ensure that jumper JP7 is shorted (closed position).	—
4	On the MCP215X Data Logger Demo Board: Insert the 9V battery into the battery holder (BT1) or plug a 9V AC-to-DC power supply (such as supplied with some Microchip development tools) into the 9V DC connection plug (J2). You may need to depress the RESET switch if the LCD does not display the Microchip program revision information and then the directions for demo program selection.	On the MCP215X Data Logger Demo Board: The green power LED (D10) will turn on, the DTR LED will be on, while all the other UART flow control signals (CTS, RTS, CD, RI and DSR) will be off. Also the RD7 and RD6 LEDs will be on.
5	On the MCP215X Data Logger Demo Board: Depress Switch 2 and Switch 3 (SW2 + SW3) simultaneously.	On the MCP215X Data Logger Demo Board: This causes the 250-byte S->P data transfer program to be executed. The LCD will display that this program was selected and will then update the display to show the two options for transmitting data from the PIC16F877 to the MCP2150: 1. CTS (transmit data bytes while CTS is low) 2. 64 bytes (transmit 64 data bytes when CTS goes low)
6	On the PDA: Start the IrDA [®] Demo program.	On the PDA: The screen will display the "IrDA Demo" program window, with the "Device ID" line displaying "Generic IrDA" and the "IR Link" line displaying "Discovery Mode".
7	On the PDA: Tap on the Connect button.	On the PDA: Once the connection is made, the program will be updated so that the Connect button is called the Disconnect button and the "IR Link" line displays "Normal Response Mode". On the MCP215X Data Logger Demo Board: The CD LED will turn on and the CTS LED will strobe rapidly and then return to the normal rate. This indicates that an IR link is established between the PDA and the demo board.

TABLE 2-7: 250-BYTE S -> P DATA TRANSFER DEMO - POCKET PC (CONTINUED)

Step	Action	Result
8	<p>On the MCP215X Data Logger Demo Board: Depress Switch 2 or Switch 3 to select which flavor of the transmit program is executed.</p>	<p>On the MCP215X Data Logger Demo Board: If Switch SW2 is depressed, then the Host Controller will only transmit data to the MCP2150 while the CTS signal is low. The LCD will indicate that the MCP215X Data Logger Demo Board is waiting to receive a data byte from the Primary device. If Switch SW3 is depressed, the Host Controller will transmit 64 bytes of data to the MCP2150 when the CTS signal goes low. The LCD will indicate that the MCP215X Data Logger Demo Board is waiting to receive a data byte from the Primary device.</p>
9	<p>On the PDA: Tap on the Get File button.</p>	<p>On the MCP215X Data Logger Demo Board: The CTS LED will strobe rapidly and then return to the normal rate. The second line of the LCD will display the text "Transmitting" and, once the data table has been sent, the text will change to "TX Complete". After approx. 1 second, the PIC16F877 will return to the routine used to select how the 250-byte table is transmitted (see Step 8). The LCD will display the options.</p> <p>On the PDA: The data is received in the program's trace buffer.</p>
10	<p>On the PDA: Tap on the Trace button.</p>	<p>On the PDA: This opens the trace buffer window. You may scroll up and down in this window to view the received data.</p>
11	<p>On the PDA: Tap on the Clear button.</p>	<p>On the PDA: This clears the data that is in the trace buffer window.</p>
12	<p>On the PDA: Tap on the Close button.</p>	<p>On the PDA: This closes the trace buffer window.</p>
13	Step 8 through Step 12 may be repeated.	—
14	<p>On the PDA: Tap on the Disconnect button.</p>	<p>On the PDA: This will disconnect (close) the IR link. When the IR Link is closed, the program window will be updated so that the Disconnect button changes back to the Connect button. The "IR Link" line will display "Normal Disconnect Mode" and then, after a couple of seconds, will display "Discovery Mode".</p> <p>On the MCP215X Data Logger Demo Board: The CD and the CTS LEDs will turn off.</p>

2.4.3 Running the MCP215X Data Logger Demo Board with a Window XP PC with an IrDA Standard Port

An overview of the Application Note 941 GUI is given (Section 2.4.3.1 “The Windows XP PC GUI”), followed by the operation of the demos (Section 2.4.3.2 “Running The Demos Using The Application Note 941 Program”).

2.4.3.1 THE WINDOWS XP PC GUI

The GUI consists of a number of user interface elements including command buttons, text labels and a text-entry field. Figure 2-11 identifies the buttons while the text below describes the operation of the button.

FIGURE 2-11: WINDOWS XP PC WINDOW

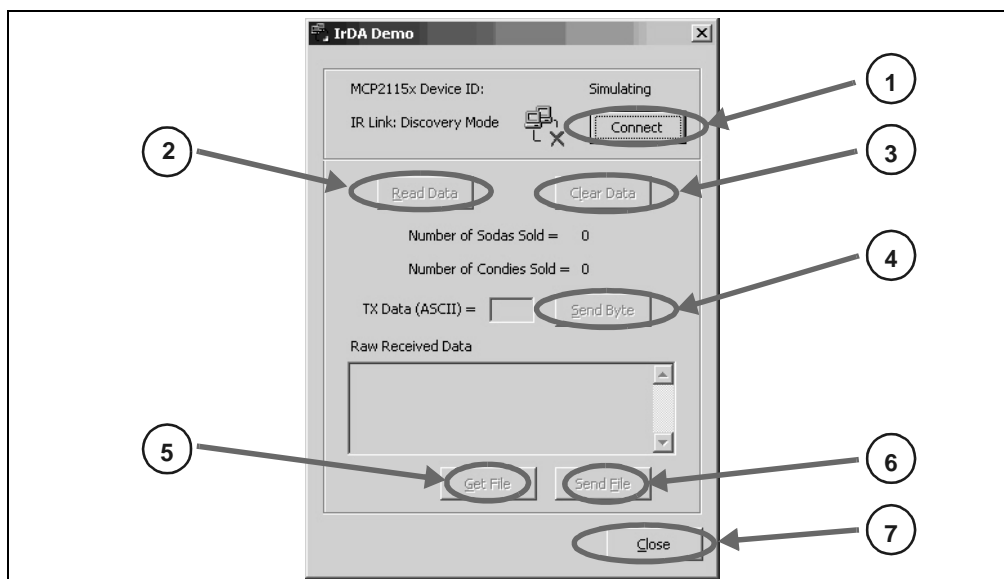

1. The **Connect** button attempts to establish a connection to the IR demo board. The PC is acting as the Primary device and the demo board acts as the Secondary device.
2. The **Read Data** button causes a query to be sent to the demo board requesting a tally of the number of sodas and candies dispensed. Data received from the demo board is parsed and displayed in text labels.
3. The **Clear Data** button sends a command to the demo board instructing it to reset the application level counters.
4. The **Send Byte** button transfers the byte entered into the TX Data (ASCII) text box. Any byte may be entered and transferred to the embedded system. If the byte corresponds to one of the commands to read data, clear data or transfer a buffer, the board will respond depending on its mode (vending machine or 250-byte transfer).
5. The **Get File** button initiates the 240-byte data transfer from the embedded system by sending the embedded system the command byte for the transfer.
6. The **Send File** button allows the user to select a file on the PC and transfer it to the embedded system.
7. The **Close** button closes the application.

2.4.3.2 RUNNING THE DEMOS USING THE APPLICATION NOTE 941 PROGRAM

After saving the AN941 application program to your PC's hard drive, the program needs to be launched. This PC program communicates with the MCP215X Data Logger Demo Board. **Section 2.4.3.2.1 "Steps to Operate the Vending Machine Demo - Windows XP"** discusses how to operate the vending machine demo, while **Section 2.4.3.2.2 "Steps to Operate the 250-byte S -> P Data Transfer Demo - Windows XP"** discusses how to operate the 250-byte Secondary device (S) to Primary device (P) data transfer demo.

2.4.3.2.1 Steps to Operate the Vending Machine Demo - Windows XP

The vending machine demo is shown by following the steps in Table 2-8.

TABLE 2-8: VENDING MACHINE DEMO - WINDOWS® XP

Step	Action	Result
1	Place both devices on a flat surface about 25 cm (10") apart, with the IR ports facing each other.	—
2	On the MCP215X Data Logger Demo Board: Ensure that jumpers JP1 and JP2 are shorted (closed position).	—
3	On the MCP215X Data Logger Demo Board: Ensure that jumper JP7 is shorted (closed position).	—
4	On the PC: Run the IrDA Demo.exe program.	On the PC: The program is searching for an IrDA standard device.
5	On the MCP215X Data Logger Demo Board: Insert the 9V battery into the battery holder (BT1) or plug a 9V AC-to-DC power supply (such as those supplied with some Microchip development tools) into the 9V DC connection plug (J2). You may need to depress the RESET switch if the LCD does not display the Microchip program revision information and then the directions for demo program selection.	On the MCP215X Data Logger Demo Board: The green power LED (D10) will turn on, the DTR LED will be on, while all the other UART flow control signals (CTS, RTS, CD, RI and DSR) are off. The RD7 and RD6 LEDs will also be on. In the IrDA® standard demo PC program window: The program should indicate that it has found an IrDA standard device, called "Generic IrDA".
6	On the PC: If the PC is configured to show the IR icon in the system tray, a single IR LED will be displayed. Place the mouse cursor over this icon.	On the PC: The message "Generic IrDA is in range" will be displayed; "Generic IrDA" is the device ID of the MCP2150.
7	On the MCP215X Data Logger Demo Board: Depress Switch 2 (SW2).	On the MCP215X Data Logger Demo Board: This causes the vending machine program to be executed.
8	In the IrDA standard demo PC program window: Depress and release the Connect button.	In the IrDA standard demo PC program window: Once the connection is made, the program window will be updated to show that the Connect button now is called the Disconnect button. On the MCP215X Data Logger Demo Board: The CD LED will turn on, and the CTS LED will flash. This indicates that an IR link has been established between the PC and the demo board.

MCP215X Data Logger Demo Board User's Guide

TABLE 2-8: VENDING MACHINE DEMO - WINDOWS® XP (CONTINUED)

Step	Action	Result
9	<p>On the PC: If the PC is configured to show the IR icon in the system tray, the single IR LED icon will change to an icon of two IR LEDs facing each other talking. Place the mouse cursor over this icon.</p>	<p>On the PC: The message "Wireless link with Generic IrDA at 115200 bps" will be displayed. This shows that a link is now established for data communication and that the IR communication rate is 115200 bps, the baud rate that was negotiated between the PC IrDA standard hardware and the MCP2150.</p>
10	<p>On the MCP215X Data Logger Demo Board: Switch 2 (SW2) increments the soda counter, while Switch 3 (SW3) increments the candy counter. The value of the candy and soda counters will be displayed on the LCD. Depress Switch 2 until the soda counter displays 7 and depress Switch 3 until the candy counter displays 12. For demonstration purposes, it is nice when the two counter values are different.</p>	—
11	<p>In the IrDA standard demo PC program window: Depress and release the Read Data button.</p>	<p>On the MCP215X Data Logger Demo Board: The CTS LED will strobe rapidly and then return to the normal rate.</p> <p>In the IrDA standard demo PC program window: The program window will update the display for "Number of Sodas Sold =" and "Number of Candies Sold =" to the value displayed on the demo board LCD. At the bottom of the IrDA standard demo PC program window, there is an area that displays the raw data received from the MCP215X Data Logger Demo Board.</p>
12	<p>On the MCP215X Data Logger Demo Board: Update the soda and candy counters by depressing Switch 2 until the soda counter displays 14 and depressing Switch 3 until the candy counter displays 16.</p>	—
13	<p>In the IrDA standard demo PC program window: Depress and release the Read Data button.</p>	<p>On the MCP215X Data Logger Demo Board: The CTS LED will strobe rapidly before returning to the normal rate.</p> <p>In the IrDA standard demo PC program window: The program window will update the display for "Number of Sodas Sold =" and "Number of Candies Sold =" to the new value displayed on the demo board LCD. There is an area at the bottom of the IrDA standard demo PC program window that displays the raw data received from the MCP215X Data Logger Demo Board.</p>
14	Step 12 and then Step 13 may be repeated.	—
15	<p>In the IrDA standard demo PC program window: Depress and release the Disconnect button.</p>	<p>In the IrDA standard demo PC program window: This will disconnect (close) the IR link. When the IR link is disconnected, the PC icon will change to indicate that the IR link is disconnected (has a red X).</p> <p>On the MCP215X Data Logger Demo Board: The CD and the CTS LEDs will turn off.</p>
16	If the PC is configured to show the IR icon in the system tray, a single IR LED will be displayed.	—

2.4.3.2.2 Steps to Operate the 250-byte S -> P Data Transfer Demo - Windows XP
The 250-byte S -> P data transfer demo is shown by the steps in Table 2-9.

TABLE 2-9: 250 BYTE S -> P DATA TRANSFER DEMO - WINDOWS® XP

Step	Action	Result
1	Place both devices on a flat surface about 25 cm (10") apart, with the IR ports facing each other.	—
2	On the MCP215X Data Logger Demo Board: Ensure that jumpers JP1 and JP2 are shorted (closed position).	—
3	On the MCP215X Data Logger Demo Board: Ensure that jumper JP7 is shorted (closed position).	—
4	On the PC: Run the IrDA Demo.exe program.	On the PC: The program is searching for an IrDA® standard device.
5	On the MCP215X Data Logger Demo Board: Insert the 9V battery into the battery holder (BT1) or plug a 9V AC-to-DC power supply (such as those supplied with some Microchip development tools) into the 9V DC connection plug (J2). You may need to depress the RESET switch if the LCD does not display the Microchip program revision information, as well as the directions for demo program selection.	On the MCP215X Data Logger Demo Board: The green power LED (D10) will turn on, the DTR LED will be on, while all the other UART Flow Control signals (CTS, RTS, CD, RI and DSR) will be off. Also the RD7 and RD6 LEDs will be on.
		In the IrDA Demo PC program window: The program should indicate that it has "found" an IrDA standard device, called "Generic IrDA".
6	On the PC: If the PC is configured to show the IR icon in the system tray, a single IR LED will be displayed. Place the mouse cursor over this icon.	On the PC: The message "Generic IrDA is in range" will be displayed. "Generic IrDA" is the device ID of the MCP2150.
7	On the MCP215X Data Logger Demo Board: Depress Switch 2 and Switch 3 (SW2 + SW3) simultaneously.	On the MCP215X Data Logger Demo Board: This causes the 250-byte S->P data transfer program to be executed. The LCD will display that this program was selected and then update the display to show the two options for transmitting data from the PIC16F877 to the MCP2150: 1. CTS (transmit data bytes while CTS is low) 2. 64 bytes (transmit 64 data bytes when CTS goes low)
8	On the MCP215X Data Logger Demo Board: Depress Switch 2 and Switch 3 to select which flavor of the program is executed.	On the MCP215X Data Logger Demo Board: If SW2 is depressed, the Host Controller will only transmit data to the MCP2150 while the CTS signal is low. The LCD will indicate that the MCP215X Data Logger Demo Board is waiting to receive a data byte from the Primary device. If SW3 is depressed, the Host Controller will transmit 64 bytes of data to the MCP2150 when the CTS signal goes low. The LCD will indicate that the MCP215X Data Logger Demo Board is waiting to receive a data byte from the Primary device.

MCP215X Data Logger Demo Board User's Guide

TABLE 2-9: 250 BYTE S -> P DATA TRANSFER DEMO - WINDOWS® XP (CONTINUED)

Step	Action	Result
9	In the IrDA standard demo PC program window: Depress and release the Connect button.	<i>In the IrDA standard demo PC program window:</i> Once the connection is made, the program window will be updated to show that the Connect button now is called the Disconnect button. <i>On the MCP215X Data Logger Demo Board:</i> The CD LED will turn on and the CTS LED will flash. This indicates that an IR link is established between the PC and the demo board.
10	<i>On the PC:</i> If the PC is configured to show the IR icon in the system tray, the single IR LED icon will change to an icon of two IR LEDs facing each other and talking. Place the mouse cursor over this icon.	<i>On the PC:</i> The message "Wireless link with Generic IrDA at 115200 bps" will be displayed. This shows that a link is now established for data communication and that the IR communication rate is 115200 bps, the baud rate that was negotiated between the PC IrDA standard hardware and the MCP2150.
11	In the IrDA standard demo PC program window: In the TX Data (ASCII) entry box, type in any number (such as "5").	—
12	In the IrDA standard demo PC program window: Depress and release the Send Byte button.	<i>On the MCP215X Data Logger Demo Board:</i> The CTS LED will strobe rapidly and then return to the normal rate, with the PORTD LEDs showing the ASCII value for the data byte transmitted ("5" = 0x35). After approx. 1 second, the PIC16F877 will return to the routine used to select how the 250-byte table is transmitted (see Step 7). The LCD will display the options. <i>In the IrDA standard demo PC program window:</i> The "Raw Received Data" window will display the data table that was transmitted by the MCP215X Data Logger Demo Board. This table is shown in Appendix D. "MCP215X 250-Byte Data Transmit Table" . The scroll bar may be used to inspect the data received.
13	Step 7 through Step 12 may be repeated.	—
14	In the IrDA standard demo PC program window: Depress and release the Disconnect button.	<i>In the IrDA standard demo PC program window:</i> This will disconnect (close) the IR link. When the IR link is disconnected, the PC icon will change to indicate that the IR link is disconnected (has a red X). <i>On the MCP215X Data Logger Demo Board:</i> The CD and the CTS LEDs will turn off.
15	If the PC is configured to show the IR icon in the system tray, a single IR LED will be displayed.	—

2.5 MCP215X DATA LOGGER DEMO BOARD DESCRIPTION

The following sections describe each element of this demo board in further detail.

2.5.1 Power

The MCP215X Data Logger Demo Board is powered by either a single 9V battery or an AC-to-9V power supply. This voltage is regulated to a nominal voltage of 4.5V. The green LED (D10) is the power indicator, turning on when power is applied.

2.5.2 MCP215X IrDA Protocol Stack Controller Device

This demo board highlights the MCP2150 or the MCP2155 IrDA Protocol Stack Controller device (U2) to demonstrate the implementation of an IR port in an embedded system application. The MCP215X device handles all IrDA standard protocol tasks, while allowing the system designer to easily interface the device to a microcontroller via a standard UART port.

The key signals for the MCP2150-to-microcontroller (Host UART) interface are shown in Table 2-10, while Table 2-11 shows these signals for the MCP2155. The operation of the host UART interface is slightly different for the MCP2150 and the MCP2155. Further information on the Host Controller interface may be obtained from the device documentation:

- MCP2150 data sheet, “IrDA[®] Standard Protocol Stack Controller Supporting DTE Applications”, (DS21655)
- MCP2155 data sheet, “IrDA[®] Standard Protocol Stack Controller Supporting DCE Applications”, (DS21690)
- Application Note 858, “Interfacing the MCP215X to a Host Controller”, (DS00858)

MCP215X Data Logger Demo Board User's Guide

TABLE 2-10: MCP2150 HOST UART INTERFACE PINS

Pin Name	Pin Number (PDIP)	Pin Type	Buffer Type	Description
TX	8	I	TTL	Asynchronous receive; from Host Controller UART.
RX	9	O	—	Asynchronous transmit; to Host Controller UART.
RI	10	I	TTL	Ring Indicator. The value on this pin is driven high.
DSR	11	O	—	Data Set Ready. Indicates that the MCP2150 has completed reset: 1 = MCP2150 is initialized. 0 = MCP2150 is not initialized.
DTR	12	I	TTL	Data Terminal Ready. The value of this pin is ignored once the MCP2150 is initialized. It is recommended that this pin be connected so that the voltage level is either Vss or Vcc. At device power-up, this signal is used with the RTS signal to enter device ID programming. 1 = Enter device ID programming mode (if RTS is cleared). 0 = Do not enter device ID programming mode.
CTS	13	O	—	Clear-to-Send. Indicates that the MCP2150 is ready to receive data from the Host Controller. This signal is locally emulated and not related to the CTS/RTS bit of the IrDA [®] standard Primary device. 1 = Host Controller should not send data. 0 = Host Controller may send data.
RTS	14	I	TTL	Request-to-Send. Indicates that a Host Controller is ready to receive data from the MCP2150. This signal is locally emulated and not related to the CTS/RTS bit of the IrDA standard Primary device. 1 = Host Controller not ready to receive data. 0 = Host Controller ready to receive data. At device power-up, this signal is used with the DTR signal to enter device ID programming. 1 = Do not enter device ID programming mode. 0 = Enter device ID programming mode (if DTR is set).
CD	19	I	ST	Carrier Detect. Indicates that the MCP2150 has established a valid link with a Primary Device. 1 = An IR link has not been established (No IR Link). 0 = An IR link has been established (IR link).

Legend: TTL = TTL compatible input
I = Input

ST = Schmitt Trigger input with CMOS levels
O = Output

TABLE 2-11: MCP2155 HOST UART INTERFACE PINS

Pin Name	Pin Number (PDIP)	Pin Type	Buffer Type	Description
TX	8	I	TTL	Asynchronous receive; from Host Controller UART.
RX	9	O	—	Asynchronous transmit; to Host Controller UART.
RI	10	I	TTL	Ring Indicator. The state of this bit is communicated to the IrDA [®] standard Primary device. 1 = No Ring Indicate Present. 0 = Ring Indicate Present.
DSR	11	O	—	Data Set Ready. Indicates that the MCP2150 has established a valid IrDA standard link with a Primary device. This signal is locally emulated and not related to the DTR bit of the IrDA standard Primary device. (Note 1) 1 = An IR link has not been established (No IR Link). 0 = An IR link has been established (IR link).
DTR	12	I	TTL	Data Terminal Ready. Indicates that the embedded device connected to the MCP2150 is ready for IR data. The state of this bit is communicated to the IrDA standard Primary device, via the IrDA standard DSR bit carried by IrCOMM. 1 = Embedded device not ready. 0 = Embedded device ready.
CTS	13	O	—	Clear-to-Send. Indicates that the MCP2150 is ready to receive data form the Host Controller. This signal is locally emulated and not related to the CTS/RTS bit of the IrDA standard Primary device. 1 = Host Controller should not send data. 0 = Host Controller may send data.
RTS	14	I	TTL	Request-to-Send. Indicates that a Host Controller is ready to receive data from the MCP2150. This signal is locally emulated and not related to the CTS/RTS bit of the IrDA standard Primary device. 1 = Host Controller not ready to receive data. 0 = Host Controller ready to receive data.
CD	19	I	ST	Carrier Detect. The state of this bit is communicated to the IrDA standard Primary device via the IrDA standard CD bit. 1 = No Carrier Present. 0 = Carrier Present.

Legend: TTL = TTL compatible input ST = Schmitt Trigger input with CMOS levels
I = Input O = Output

Note 1: The state of the DTR output pin does not reflect the state of the DTR bit of the IrDA standard Primary device.

MCP215X Data Logger Demo Board User's Guide

The key signals for the MCP215X-to-IR transceiver circuit are shown in Table 2-12.

TABLE 2-12: MCP2150 IR INTERFACE PINS

Pin Name	Pin Number (PDIP)	Pin Type	Buffer Type	Description
TXIR	2	O	—	Asynchronous transmit to IrDA [®] standard transceiver.
RXIR	3	I	ST	Asynchronous receive from Infrared transceiver.

Legend: A = Analog
I = Input
P = Power
O = Output

In addition to the signals described in Tables 2-10 through 2-12, the MCP215X RESET input is connected to the RESET output of the Host Controller (PIC16F877 I/O pin RC0), which asserts low after the RESET push button switch is asserted and the OSC1 and OSC2 pins are connected to an external 11.0592 MHz oscillator; specified in the MCP2150 data sheet (DS21655) and the MCP2155 data sheet (DS21690)

2.5.2.1 MCP215X OPERATION

The MCP215X (U3) implements the 9-wire “cooked” service class in the IrCOMM Application Layer protocol of the IrDA standard specification. IrCOMM is the IrDA standard specification for the replacement of the communication ports (serial and parallel) of a PC. The MCP215X allows the replacement of the serial cable with a wireless interface. The MCP215X implements the entire protocol layer, while the Host Controller (PIC16F877) talks to the MCP215X as if it were a serial port with flow control.

The MCP215X operates as a Secondary device only, so it will not initiate IrDA standard communication with other IrDA standard devices (neither a Secondary or Primary device).

Appendix C. “MCP215X Connection Sequence Overview” shows the connection sequence between a Primary device and the MCP215X (Secondary device). This connection sequence is shown at an overview level and does not show exact operation.

2.5.3 PICmicro[®] Microcontroller Functions

The MCP215X interfaces to the PIC16F877 (or PIC16F877A) microcontroller (U1). This device was chosen for this application because it has a UART port, an A/D Converter (ADC), Flash memory for reprogrammability, a sufficient number of I/O pins to interface to the LED and LCD module and is low power.

The $\overline{\text{MCLR}}$ input of the PIC16F877 is connected to the **RESET** push button switch. The device is reset when the **RESET** push button is depressed.

The PIC16F877 RA5 pin is connected to the S2 push button switch, while the RA4 pin is connected to the S3 push button switch. After device reset, the state of these switches is polled to determine which firmware program (vending machine or 250-byte S → P data transmit) to execute.

The PIC16F877 is connected to a standard In-Circuit Serial Programming[™] (ICSP[™]) header (J3) to allow easy program access to the device.

2.5.4 IR Transceiver Circuit

The IR transceiver circuit uses a Vishay[®] TFDS 4500 integrated optical transceiver.

2.5.5 Signal Header

To allow easy access to many of the system signals, a header (J4) was placed on one of the edges of the board. This allows the signals from the MCP2150 or MCP2155 to be accessed.

FIGURE 2-12: SIGNAL INTERFACE HEADER J4

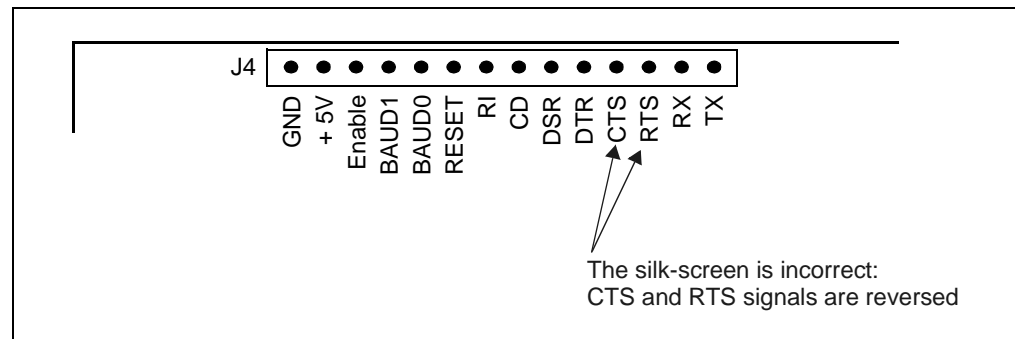

2.5.6 Using the Integrated Optical Transceiver (U5)

To use the integrated optical transceiver, it must be electrically powered and connected to the system. Connecting the integrated optical transceiver is done by:

1. Shorting Jumper JP7.
(this connects VDD to the integrated optical transceiver (U5))
2. Shorting Jumper JP1.
If jumper JP1 is removed, ensure that the short between two pins (on bottom-side of board) is present.
3. Shorting Jumper JP2.
If jumper JP2 is removed, ensure that the short between two pins (on bottom-side of board) is present.

Now the integrated optical transceiver should be operational.

2.5.7 Using a Discrete Optical Transceiver Daughter Board via Headers J1 and J5

To use an alternative optical transceiver, a daughter board can be connected to the MCP215X Data Logger Demo Board via the connection header of J1 and J5 (see Figure 2-13). The integrated optical transceiver on the MCP215X Data Logger Demo Board must be electrically removed from the system. The following explains how to accomplish this:

1. Remove Jumper on JP7 (this removes VDD from the integrated optical transceiver (U5)).
2. Remove Jumper on JP1.
If jumper is removed, ensure that the short between two pins (on bottom side of board) has been cut.
3. Remove Jumper on JP2.
If jumper is removed, ensure that the short between two pins (on bottom side of board) has been cut.
4. Plug the discrete optical transceiver board into Header J1 and J5.

Now the optical transceiver daughter board should be operational.

FIGURE 2-13: OPTICAL TRANSCEIVER DAUGHTER BOARD INTERFACE HEADER (J1 AND J5)

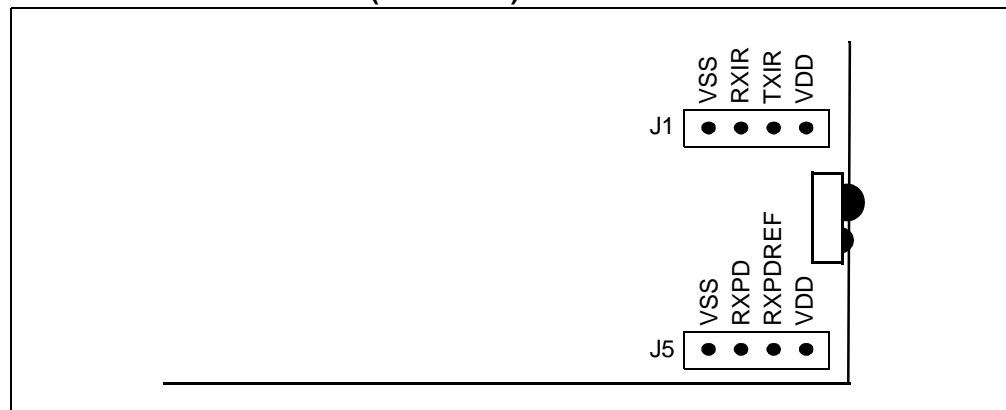

Appendix A. Schematic and Layouts

A.1 INTRODUCTION

This appendix contains the following schematics and layouts for the MCP215X Data Logger Demo Board:

- Board Schematic - Digital circuitry
- Board Schematic - Analog circuitry
- Board - Top Layer
- Board - Bottom Layer
- Board - Ground Layer
- Board - Power Layer

A.2 SCHEMATICS AND PCB LAYOUT

Figure A-2 shows the MCP215X Data Logger Demo Board schematic, while Figure A-3 and Figure A-4 show the layout for the two different layers. The layer order is shown in Figure A-1.

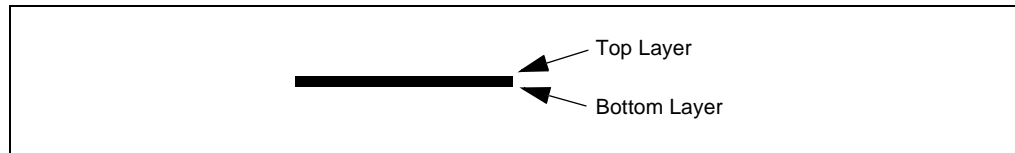
FIGURE A-1: LAYER ORDER

MCP215X Data Logger Demo Board User's Guide

FIGURE A-2: MCP215X DATA LOGGER DEMO BOARD SCHEMATIC

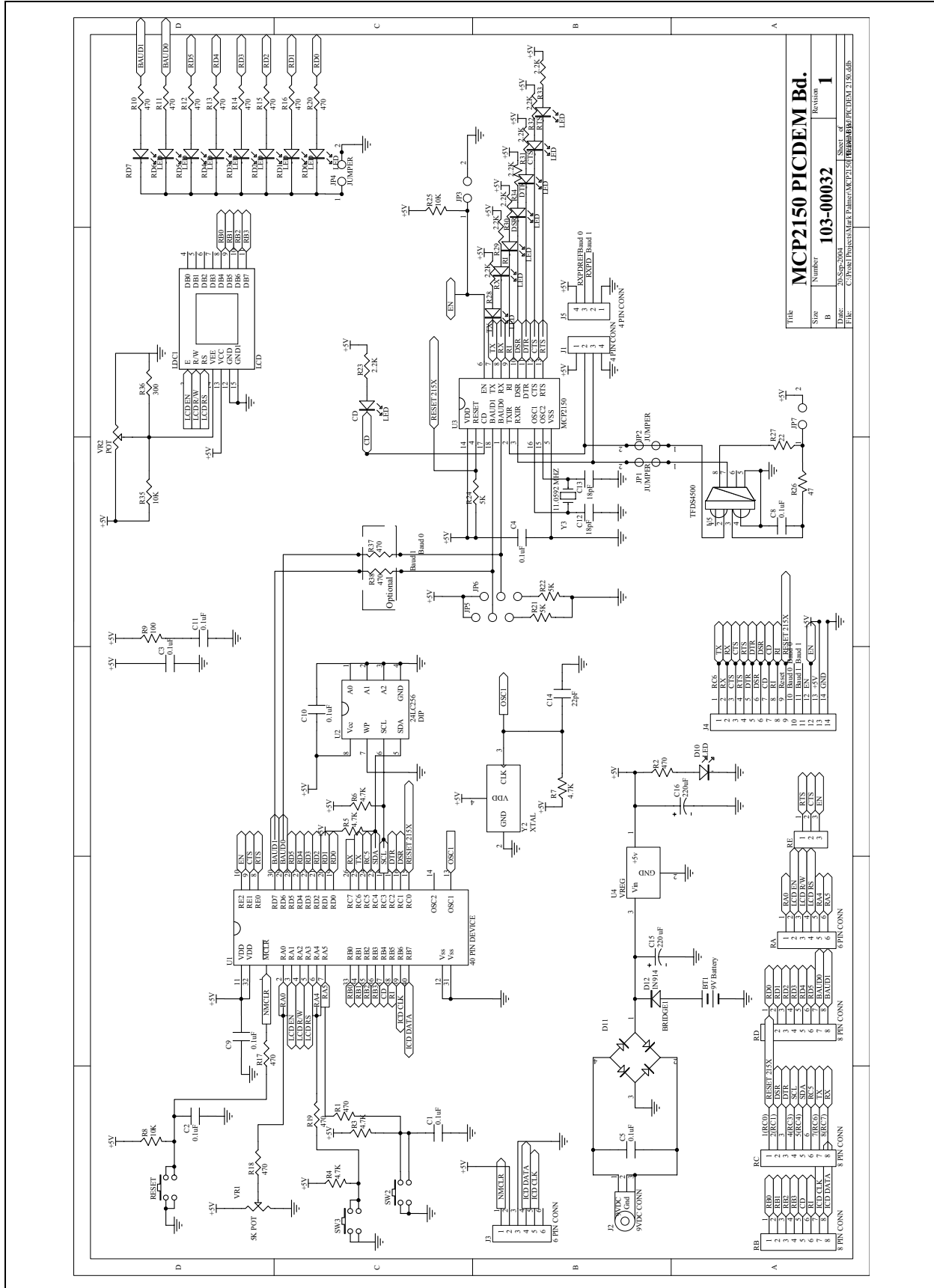
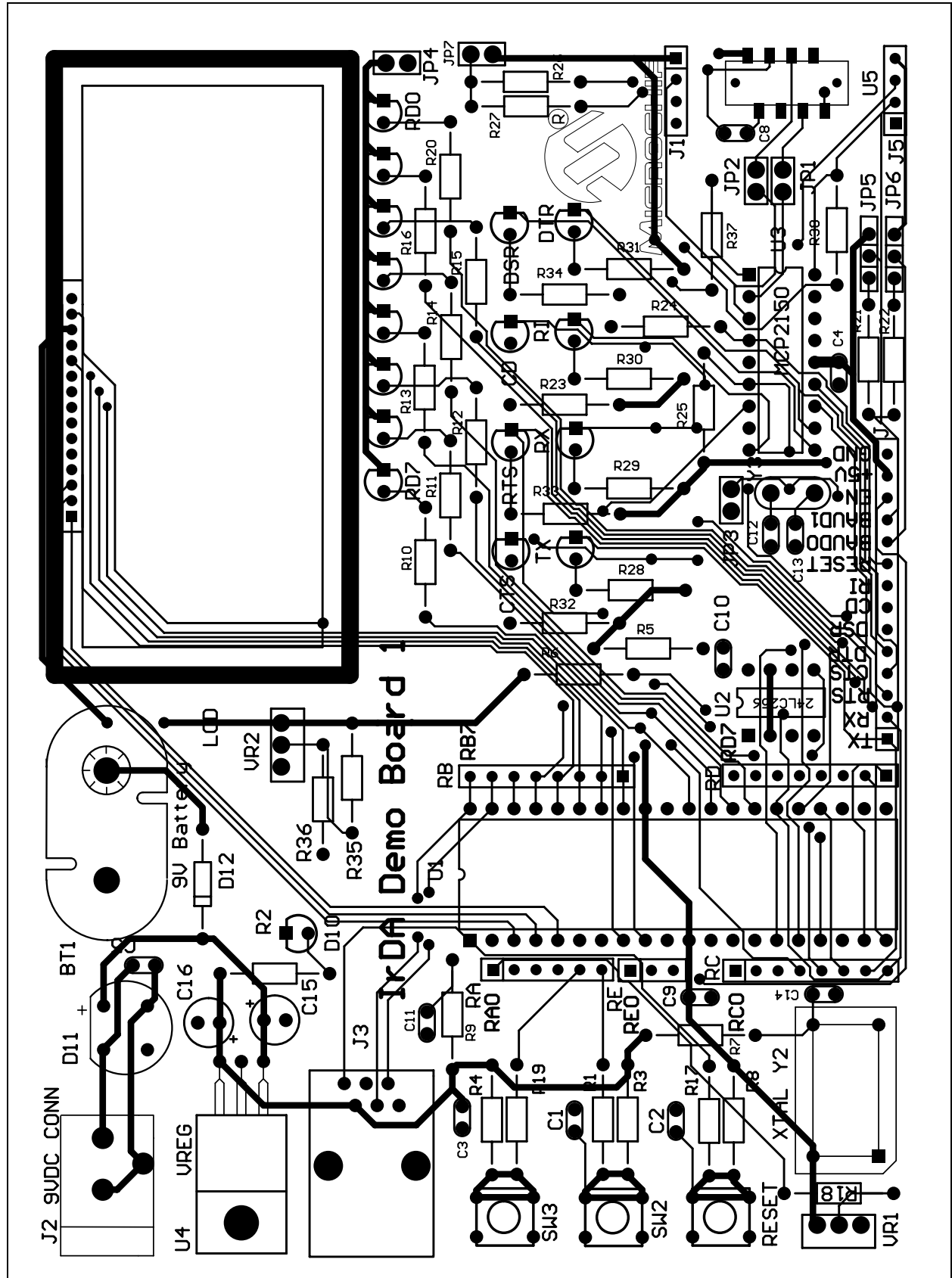
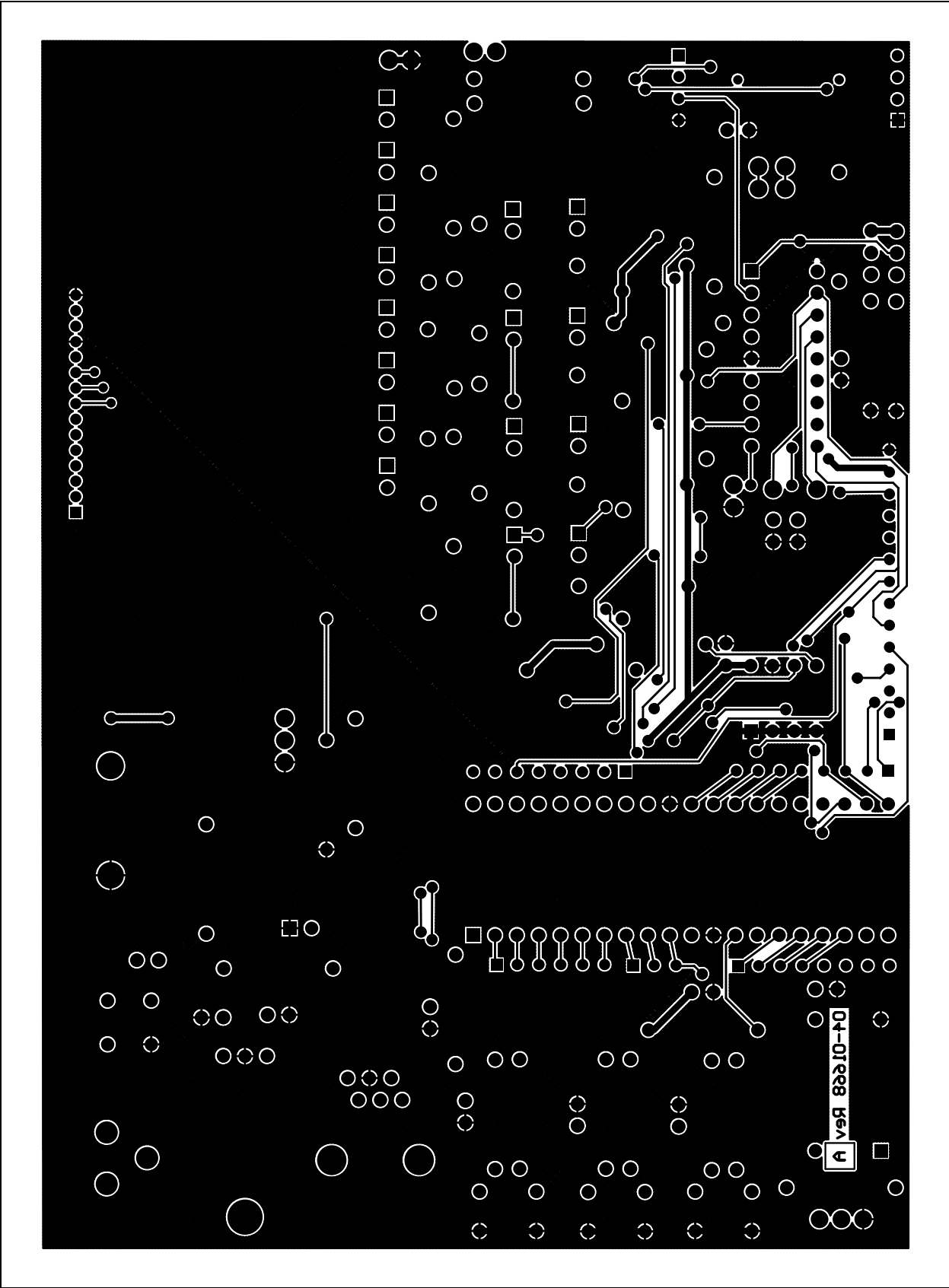

FIGURE A-3: MCP215X DATA LOGGER DEMO BOARD LAYOUT - TOP LAYER



MCP215X Data Logger Demo Board User's Guide

FIGURE A-4: MCP215X DATA LOGGER DEMO BOARD LAYOUT - BOTTOM LAYER





MCP215X DATA LOGGER DEMO BOARD USER'S GUIDE

Appendix B. Bill-Of-Materials (BOM)

TABLE B-1: BILL-OF-MATERIALS (BOM)

Qty	Reference	Description	Manufacturer	Part Number
9	C1,C2,C3,C4, C5,C8,C9,C10, C11	Capacitor, Ceramic, MONO, .1 μ F, 50V 10%	Panasonic [®] - ECG	ECU-S1H104KBB
2	C12,C13	Capacitor, 18 pF, 100V, 5%, MONOLITH Ceramic	Panasonic - ECG	ECU-S2A180JCA
1	C14	Capacitor, 22 pF, 100V, 5%, MONOLITH Ceramic	Panasonic - ECG	ECU-S2A220JCA
2	C15,C16	Capacitor, 220 μ F, 25V, Alum Lytic Radial	Panasonic - ECG	ECA-1EM221
1	D12	Diode, SS, HI COND, 100V, 200 mA, DO-35	Fairchild Semiconductor [®]	1N914TR
8	R31,R23,R29,R33 R28,R30,R32,R34	RES 2.2 k Ω , 1/4W 5%, Carbon Film	Yageo America	CFR-25JB-2K2
5	R3,R4,R5,R6,R7	Resistor, 4.7 k Ω , 1/4W 5%, Carbon Film	Yageo America	CFR-25JB-4K7
3	R8,R25,R35	Resistor, 10 k Ω , 1/4W, 5%, Carbon Film	Yageo America	CFR-25JB-10K
3	R21,R22,R24	Resistor, 5.1 k Ω , 1/4W, 5%, Carbon Film	Yageo America	CFR-25JB-5K1
1	R26	Resistor, 47 Ω , 1/4W, 5%, Carbon Film	Yageo America	CFR-25JB-47R
1	R27	Resistor, 22 Ω , 1/4W, 5%, Carbon Film	Yageo America	CFR-25JB-22R
1	R9	Resistor, 100 Ω , 1/4W, 5%, Carbon Film	Yageo America	CFR-25JB-100R
1	R36	Resistor, 300 Ω , 1/4W, 5%, Carbon Film	Yageo America	CFR-25JB-300R
15	R1,R2,R10, R11, R12, R13, R14, R15, R16, R17, R18, R19, R20, R37,38	Resistor, 470 Ω , 1/4W, 5%, Carbon Film	Yageo America	CFR-25JB-470R
5	JP1,JP2,JP3, JP4,JP7	Conn Header, 2POS, .100, VERT TIN	Molex [®] /Waldom [®] Electronics Corp	22-28-4020
3	JP5,JP6,RE	Conn Header, 3POS, .100, VERT TIN	Molex/Waldom Electronics Corp	22-28-4030
2	J1,J5	Conn Header, 4POS, .100, VERT TIN	Molex/Waldom Electronics Corp	22-28-4040
1	RA	Conn Header, 6POS, .100, VERT TIN	Molex/Waldom Electronics Corp	22-28-4060
3	RB,RC,RD	Conn Header, 8POS, .100, VERT TIN	Molex/Waldom Electronics Corp	22-28-4080
3	JP1,JP2 JP4	SHUNT LP W/HANDLE 2POS 30AU	AMP/Tyco Electronics	881545-2
1	BT1	Conn, PC VERT 9V SNAP-ON	Keystone Electronics [®]	968
1	J2	Conn, Power Jack, 2.5MM, PCB, CIRC	CUI Inc	PJ-102B
1	J3	Conn, Mod Jack, 6-6, R/A ,PCB, 50AU	AMP/Tyco Electronics	520470-3
1	VR1	Pot, 5.0 k Ω , Thumbwheel Cerm ST	Bourns Inc. [®]	3352W-1-502
1	VR2	Do not populate	Do not populate	Do not populate
1	J4	Conn Header, 14POS, .100, VERT TIN	Molex/Waldom Electronics Corp	22-28-4140

MCP215X Data Logger Demo Board User's Guide

TABLE B-1: BILL-OF-MATERIALS (BOM) (CONTINUED)

Qty	Reference	Description	Manufacturer	Part Number
1	U1	High Performance Microcontrollers with 10-bit A/D	Microchip Technology Inc.	PIC18F452-I/P
1	U1 Socket	40 Pin, IC Socket, GOLD, .600	Mill-Max Manufacturing Corp.®	110-93-640-41-001000
1	U2	256K I2C™ CMOS Serial EEPROM	Microchip Technology Inc.	24LC256
1	U2 socket	8-Pin, IC Socket, GOLD, .300	Mill-Max Manufacturing Corp.	110-93-308-41-001000
1	U3	MCP2150	Microchip Technology Inc.	MCP2150-I/P
1	U3 socket	18-Pin, IC Socket, GOLD, .300	Mill-Max Manufacturing Corp.	110-93-318-41-001000
1	U4	IC Regulator, Positive 5V, TO-220	National Semiconductor™	LM340T-5.0
1	U5	TFDS, LED, IR Serial Infrared Transceiver Module Side View	Vishay®	TFDS4500-TR3
1	D11	Rectifier Bridge, 1.5A, 200V, WOG	General Semiconductor®	W02G
1	LDC1	16 X 2 Chip On Glass LCD Display	FEMA Electronics P-Tec Corp	CG-1621-SGR1C PCOG1602C-GNFD-C
1	D10	Led, SS, Green, DIFF, RA, PCB, 3 MM	Fairchild Optoelectronics Group	MV5464MP4B
15	RD0-RD7, CD,CTS RTS,DSR,TX, RX,RI,DTR,	Led ,SS, Red, Diffused ,PCB, 3 MM	Fairchild Optoelectronics Group	MV5064MP4B
3	RESET SW2,SW3	Switch, Tact, 6 MM, MOM, 100GF	Omron Electronics, Inc®-ECB Div	B3F-1000
1	Y2	Oscillator, 20.000 MHZ, TTL	ECS Inc.	ECS-100A-200
1	Y2 Socket	Oscillator, Socket, Full Size, 4,Pin	Aries Electronics	1107741
1	Y3	Crystal, 11.0592 MHZ, 20 pF, Load Cap	CTS-Frequency Controls	ATS111
2	Y3 socket pins	Pin Recpt, .015/.025 DIA, 0667 SER	Mill-Max Manufacturing Corp.	0667-0-15-01-3027100

Appendix C. MCP215X Connection Sequence Overview

FIGURE C-1: HIGH-LEVEL MCP215X CONNECTION SEQUENCE

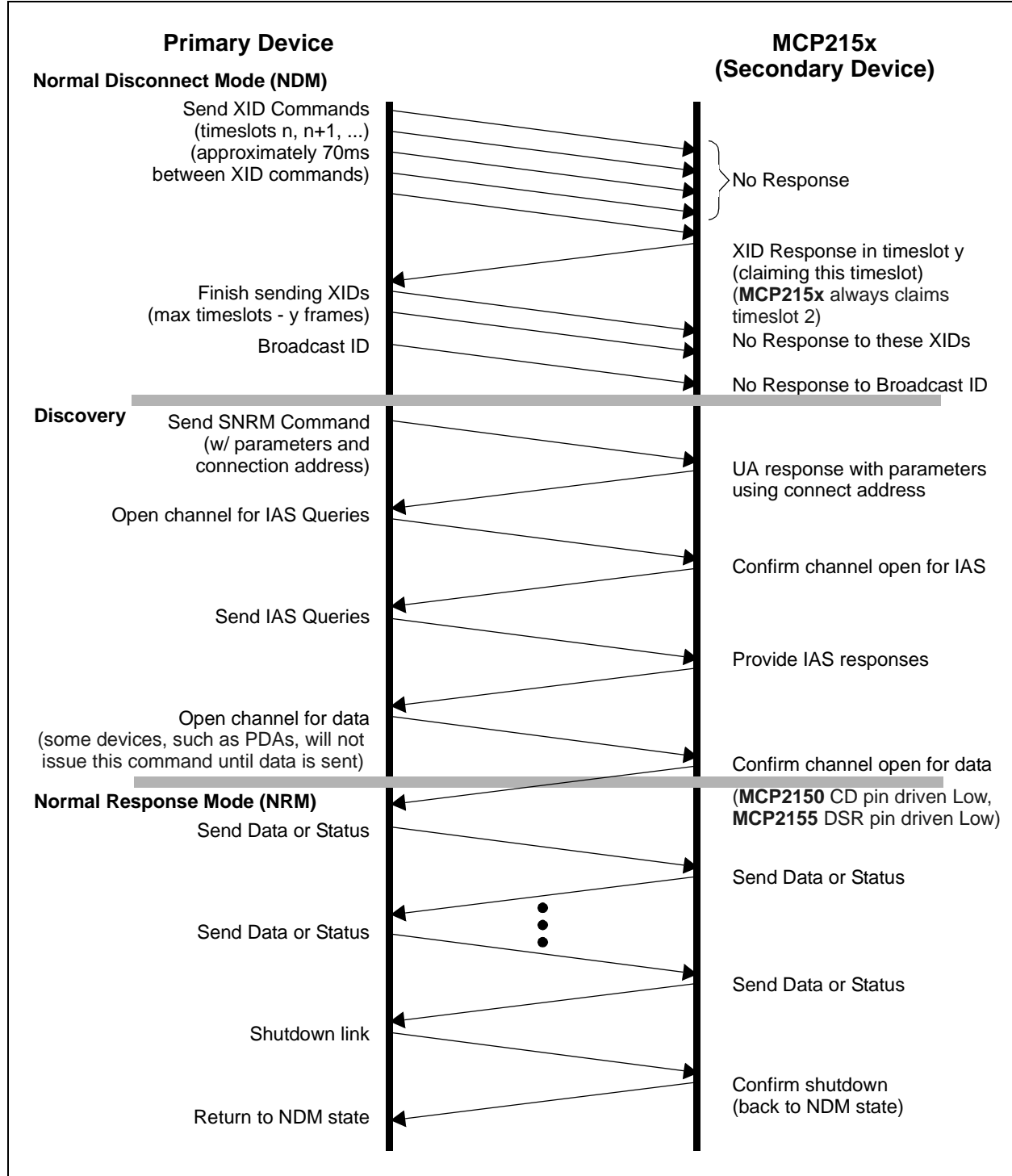

MCP215X Data Logger Demo Board User's Guide

NOTES:



MCP215X DATA LOGGER DEMO BOARD USER'S GUIDE

Appendix D. MCP215X 250-Byte Data Transmit Table

TABLE D-1: PIC16F877 250-BYTE DATA TRANSMIT TABLE

Line #	TXTB	DT	D'250'	
				; the first byte is the byte count
				; 1 Characters
1		DT	"12345678", 0x0D, 0x0A	; 10 Characters
2		DT	"2BCDEFGH", 0x0D, 0x0A	; 10 Characters
3		DT	"32345678", 0x0D, 0x0A	; 10 Characters
4		DT	"4bcdefgh", 0x0D, 0x0A	; 10 Characters
5		DT	"52345678", 0x0D, 0x0A	; 10 Characters
6		DT	"6BCDEFGH", 0x0D, 0x0A	; 10 Characters
7		DT	"72345678", 0x0D, 0x0A	; 10 Characters
8		DT	"8bcdefgh", 0x0D, 0x0A	; 10 Characters
9		DT	"92345678", 0x0D, 0x0A	; 10 Characters
10		DT	"ABCDEFGH", 0x0D, 0x0A	; 10 Characters
11		DT	"B2345678", 0x0D, 0x0A	; 10 Characters
12		DT	"Cbcdefgh", 0x0D, 0x0A	; 10 Characters
13		DT	"D2345678", 0x0D, 0x0A	; 10 Characters
14		DT	"EBCDEFGH", 0x0D, 0x0A	; 10 Characters
15		DT	"F2345678", 0x0D, 0x0A	; 10 Characters
16		DT	"1bcdefgh", 0x0D, 0x0A	; 10 Characters
17		DT	"22345678", 0x0D, 0x0A	; 10 Characters
18		DT	"3BCDEFGH", 0x0D, 0x0A	; 10 Characters
19		DT	"42345678", 0x0D, 0x0A	; 10 Characters
20		DT	"5bcdefgh", 0x0D, 0x0A	; 10 Characters
21		DT	"62345678", 0x0D, 0x0A	; 10 Characters
22		DT	"7BCDEFGH", 0x0D, 0x0A	; 10 Characters
23		DT	"82345678", 0x0D, 0x0A	; 10 Characters
24		DT	"9bcdefgh", 0x0D, 0x0A	; 10 Characters
25		DT	"a2345678", 0x0D, 0x0A	; 10 Characters
				; NOTE: 0x0D = Carriage Return, 0x0A = Line Feed
				;



WORLDWIDE SALES AND SERVICE

AMERICAS

Corporate Office

2355 West Chandler Blvd.
Chandler, AZ 85224-6199
Tel: 480-792-7200
Fax: 480-792-7277
Technical Support:
<http://support.microchip.com>
Web Address:
www.microchip.com

Atlanta

Alpharetta, GA
Tel: 770-640-0034
Fax: 770-640-0307

Boston

Westford, MA
Tel: 978-692-3848
Fax: 978-692-3821

Chicago

Itasca, IL
Tel: 630-285-0071
Fax: 630-285-0075

Dallas

Addison, TX
Tel: 972-818-7423
Fax: 972-818-2924

Detroit

Farmington Hills, MI
Tel: 248-538-2250
Fax: 248-538-2260

Kokomo

Kokomo, IN
Tel: 765-864-8360
Fax: 765-864-8387

Los Angeles

Mission Viejo, CA
Tel: 949-462-9523
Fax: 949-462-9608

San Jose

Mountain View, CA
Tel: 650-215-1444
Fax: 650-961-0286

Toronto

Mississauga, Ontario,
Canada
Tel: 905-673-0699
Fax: 905-673-6509

ASIA/PACIFIC

Australia - Sydney

Tel: 61-2-9868-6733
Fax: 61-2-9868-6755

China - Beijing

Tel: 86-10-8528-2100
Fax: 86-10-8528-2104

China - Chengdu

Tel: 86-28-8676-6200
Fax: 86-28-8676-6599

China - Fuzhou

Tel: 86-591-8750-3506
Fax: 86-591-8750-3521

China - Hong Kong SAR

Tel: 852-2401-1200
Fax: 852-2401-3431

China - Shanghai

Tel: 86-21-5407-5533
Fax: 86-21-5407-5066

China - Shenyang

Tel: 86-24-2334-2829
Fax: 86-24-2334-2393

China - Shenzhen

Tel: 86-755-8203-2660
Fax: 86-755-8203-1760

China - Shunde

Tel: 86-757-2839-5507
Fax: 86-757-2839-5571

China - Qingdao

Tel: 86-532-502-7355
Fax: 86-532-502-7205

ASIA/PACIFIC

India - Bangalore

Tel: 91-80-2229-0061
Fax: 91-80-2229-0062

India - New Delhi

Tel: 91-11-5160-8631
Fax: 91-11-5160-8632

Japan - Kanagawa

Tel: 81-45-471-6166
Fax: 81-45-471-6122

Korea - Seoul

Tel: 82-2-554-7200
Fax: 82-2-558-5932 or
82-2-558-5934

Singapore

Tel: 65-6334-8870
Fax: 65-6334-8850

Taiwan - Kaohsiung

Tel: 886-7-536-4818
Fax: 886-7-536-4803

Taiwan - Taipei

Tel: 886-2-2500-6610
Fax: 886-2-2508-0102

Taiwan - Hsinchu

Tel: 886-3-572-9526
Fax: 886-3-572-6459

EUROPE

Austria - Weis

Tel: 43-7242-2244-399
Fax: 43-7242-2244-393

Denmark - Ballerup

Tel: 45-4450-2828
Fax: 45-4485-2829

France - Massy

Tel: 33-1-69-53-63-20
Fax: 33-1-69-30-90-79

Germany - Ismaning

Tel: 49-89-627-144-0
Fax: 49-89-627-144-44

Italy - Milan

Tel: 39-0331-742611
Fax: 39-0331-466781

Netherlands - Drunen

Tel: 31-416-690399
Fax: 31-416-690340

England - Berkshire

Tel: 44-118-921-5869
Fax: 44-118-921-5820