

DESCRIPTION

The MP5121(single), MP5221(dual), and MP5421(quad) are high-speed, high-voltage rail-to-rail input-output amplifiers for use as voltage reference buffers in Thin Film Transistor Liquid Crystal Displays (TFT-LCDs). The MP5121 family provides excellent overall performance and versatility. The 20MHz –3dB bandwidth and 45V/μs slew rate make these amplifier suitable for many portable applications.

The MP5121, MP5221, and MP5421 are designed to operate at supply voltages as low as 3.2V and up to 20V at 1.6mA of supply current per amplifier. The MP5121 family has true single supply capability. The input can swing 0.5V below the negative rail and 0.5V above the positive rail. The output can swing within 100mV of each rail.

The MP5421 quad channel is available in the space-saving 14-pin TSSOP package. The MP5221 Dual channel is available in the 8-pin MSOP package and the MP5121 single channel is available in 5-pin TSOT package. All feature a standard operational amplifier pin out.

FEATURES

- 20MHz –3dB Bandwidth
- 45V/μs Slew Rate
- Single-Supply Operation: 3.2V to 20V
- Supply Current (per amplifier)1.6mA
- Unity-Gain Stable
- Output Swing within 100mV of Supply Rail
- Rail-to-Rail Input Capability
- High Output Drive Capability (50mA)
- MP5121 Available in TSOT-5
- MP5221 Available in MSOP-8
- MP5421 Available in TSSOP-14

APPLICATIONS

- TFT-LCD Drive Circuits
- Electronic Notebooks
- Electronic Games
- Touch-Screen Displays
- Personal Communication Devices
- Personal Digital Assistants (PDA)
- Portable Instrumentation
- Sampling ADC Amplifiers
- Wireless LAN
- Office Automation
- Active Filters
- ADC/DAC Buffer

"MPS" and "The Future of Analog IC Technology" are Registered Trademarks of Monolithic Power Systems, Inc.

TYPICAL APPLICATION

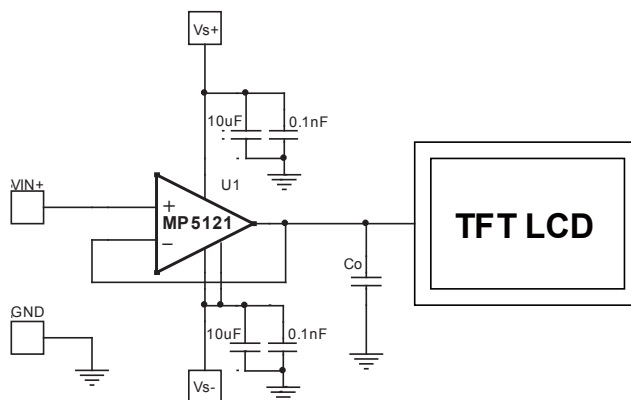

ORDERING INFORMATION

| Part Number | Package | Top Marking | Free Air Temperature (T _A) |
|-------------|----------|-------------|--|
| MP5121DJ* | TSOT23-5 | 2R | -40°C to +85°C |
| MP5221DK** | MOSP-8 | 5221D | |
| MP5421DM*** | TSSOP-14 | M5421DM | |

- * For Tape and Reel, add suffix -Z (eg. MP5121DJ-Z).
For RoHS Compliant Packaging, add suffix-LF (eg. MP5121DJ-LF-Z).
- ** For Tape and Reel, add suffix -Z (eg. MP5221DK-Z).
For RoHS Compliant Packaging, add suffix-LF (eg. MP5221DK-LF-Z).
- *** For Tape and Reel, add suffix -Z (eg. MP5421DM-Z).
For RoHS Compliant Packaging, add suffix-LF (eg. MP5421DM-LF-Z).

PACKAGE REFERENCE

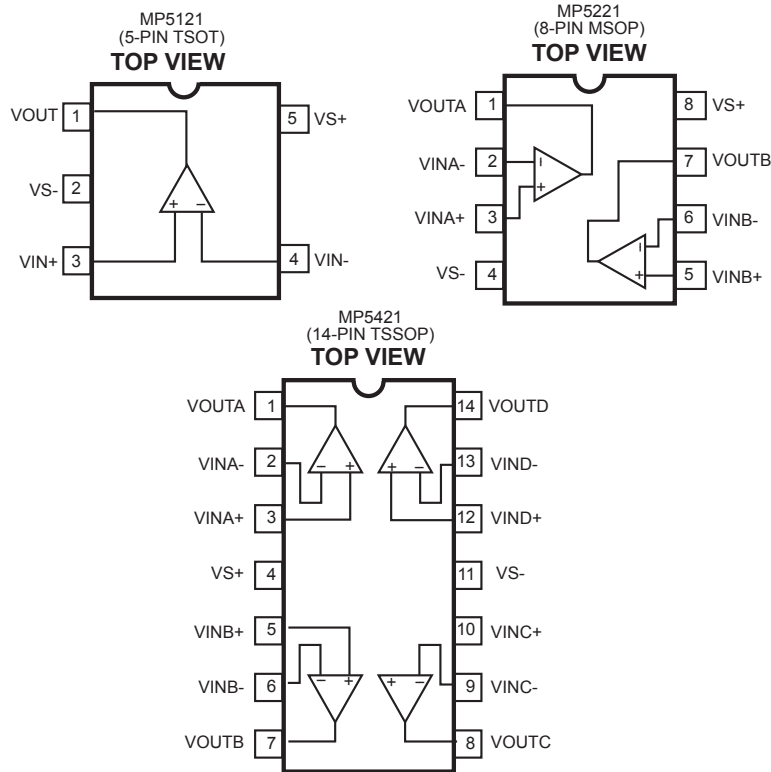

ABSOLUTE MAXIMUM RATINGS ⁽¹⁾
(T_A=25°C)

Single Supply Voltage V_S.....-0.3V to +23V
 Input Voltage..... V_S- - 0.5V, V_S+ +0.5V
 Maximum Continuous Output Current
 50mA
 Maximum Die Temperature+125°C
 Storage Temperature..... -60°C to +150°C
 Ambient Operating Temp..... -40°C to +85°C
 Power Dissipation. See Curves ⁽²⁾

Recommended Operating Conditions ⁽³⁾

Single Power Supply Operation V_S
3.2V to + 20V
 Operating Junct. Temp (T_J)..... -40°C to +125°C

| Thermal Resistance ⁽⁴⁾ | θ_{JA} | θ_{JC} |
|--|-----------------------|-----------------------|
| MSOP | 150 | 65.. °C/W |
| TSOT | 220 | 110.. °C/W |
| TSSOP | 40 | 6... °C/W |

Notes:

- 1) Exceeding these ratings may damage the device.
- 2) The maximum allowable power dissipation is a function of the maximum junction temperature T_J (MAX), the junction-to-ambient thermal resistance θ_{JA}, and the ambient temperature T_A. The maximum allowable continuous power dissipation at any ambient temperature is calculated by P_D (MAX) = (T_J (MAX)-T_A)/θ_{JA}. Exceeding the maximum allowable power dissipation will cause excessive die temperature, and the regulator will go into thermal shutdown. Internal thermal shutdown circuitry protects the device from permanent damage.
- 3) The device is not guaranteed to function outside of its operating conditions.
- 4) Measured on JESD51-7, 4-layer PCB

ELECTRICAL CHARACTERISTICS

$V_S = 10V$, $V_{CM} = 5V$, $V_{OUT} = 5V$, $R_L = 10k\Omega$ and $C_L = 10pF$, $T_A = T_J = 25^\circ C$, unless otherwise noted.

| Parameter | Symbol | Condition | Min | Typ | Max | Units |
|----------------------------------|------------|--|------|-------|------|----------------|
| INPUT CHARACTERISTICS | | | | | | |
| Input Offset Voltage | V_{OS} | | | 2 | 20 | mV |
| Average Offset Voltage Drift | TCV_{OS} | | | 5 | | $\mu/^\circ C$ |
| Input Bias Current | I_B | | | 0.5 | 2 | μA |
| Input Impedance | R_{IN} | | | 1 | | $G\Omega$ |
| Input Capacitance | C_{IN} | | | 1.35 | | pF |
| Common-Mode Input Range | CMIR | | -5.5 | | +5.5 | V |
| Common-Mode Rejection Ratio | CMRR | for V_{IN} from -5.5V to +5.5V | 60 | 85 | | dB |
| Open Loop Gain | A_{VOL} | $-4.5V \leq V_{OUT} \leq +4.5V$ | 50 | 60 | | dB |
| OUTPUT CHARACTERISTICS | | | | | | |
| Output Swing Low | V_{OL} | $I_L = -5mA$ | | -4.95 | | V |
| Output Swing High | V_{OH} | $I_L = -5mA$ | | 4.82 | | V |
| Short Circuit Current | I_{SC} | Sourcing | | 70 | | mA |
| POWER SUPPLY PERFORMANCE | | | | | | |
| Power Supply Rejection Ratio | PSRR | V_S is moved from $\pm 2.25V$ to $\pm 7.75V$ | 70 | 95 | | dB |
| Supply Current (Per Amplifier) | I_S | No load | | 1.6 | | mA |
| DYNAMIC PERFORMANCE | | | | | | |
| Slew Rate (Rise/Fall) | SR | $-4.0V \leq V_{OUT} \leq +4.0V$, 20% to 80% | | 45 | | $V/\mu s$ |
| Settling to +0.1% ($A_V = +1$) | t_s | ($A_V = +1$), $V_O = 2V$ step | | 500 | | ns |
| -3dB Bandwidth | BW | $R_L = 10k\Omega$, $C_L = 10pF$ | | 20 | | MHz |
| Gain-Bandwidth Product | GBWP | $R_L = 10k\Omega$, $C_L = 10pF$ | | 14 | | MHz |
| Phase Margin | PM | $R_L = 10k\Omega$, $C_L = 10pF$ | | 50 | | |
| Channel Separation | CS | $f = 5MHz$ (MP5221 & MP5421 only) | | 70 | | dB |

ELECTRICAL CHARACTERISTICS (continued)
 $V_S = 20V, V_{CM} = 10V, V_{OUT} = 10V, R_L = 10k\Omega$ and $C_L = 10pF, T_A = 25^\circ C$, unless otherwise noted.

| Parameter | Symbol | Condition | Min | Typ | Max | Units |
|----------------------------------|------------|--|-----|---------|-----|----------------|
| INPUT CHARACTERISTICS | | | | | | |
| Input Offset Voltage | V_{OS} | | | 2 | 20 | mV |
| Average Offset Voltage Drift | TCV_{OS} | | | 5 | | $\mu/^\circ C$ |
| Input Bias Current | I_B | | | 0.5 | 2 | μA |
| Input Impedance | R_{IN} | | | 1 | | $G\Omega$ |
| Input Capacitance | C_{IN} | | | 1.35 | | pF |
| Common-Mode Input Range | CMIR | | | ± 8 | | V |
| Common-Mode Rejection Ratio | CMRR | for V_{IN} from -8V to +8V | 60 | 85 | | dB |
| Open Loop Gain | A_{VOL} | $-9V \leq V_{OUT} \leq +9V$ | 50 | 60 | | dB |
| OUTPUT CHARACTERISTICS | | | | | | |
| Output Swing Low | V_{OL} | $I_L = -5mA$ | | -4.95 | | V |
| Output Swing High | V_{OH} | $I_L = -5mA$ | | 4.82 | | V |
| Short Circuit Current | I_{SC} | Sourcing | | 70 | | mA |
| POWER SUPPLY PERFORMANCE | | | | | | |
| Power Supply Rejection Ratio | PSRR | V_S is moved from $\pm 2.25V$ to $\pm 7.75V$ | 70 | 95 | | dB |
| Supply Current (Per Amplifier) | I_S | No load | | 1.6 | | mA |
| DYNAMIC PERFORMANCE | | | | | | |
| Slew Rate | SR | $-4.0V \leq V_{OUT} \leq +4.0V, 20\%$ to 80% | | 45 | | $V/\mu s$ |
| Settling to +0.1% ($A_V = +1$) | t_s | ($A_V = +1$), $V_O = 2V$ step | | 500 | | ns |
| -3dB Bandwidth | BW | $R_L = 10k\Omega, C_L = 10pF$ | | 20 | | MHz |
| Gain-Bandwidth Product | GBWP | $R_L = 10k\Omega, C_L = 10pF$ | | 14 | | MHz |
| Phase Margin | PM | $R_L = 10k\Omega, C_L = 10pF$ | | 50 | | |
| Channel Separation | CS | $f = 5MHz$ (MP5221 & MP5421 only) | | 70 | | dB |

TYPICAL PERFORMANCE CHARACTERISTICS

$V_{S+}=5V$, $V_{S-}=-5V$, $R_L=10K\Omega$, $C_L=12pF$, $T_A=25^\circ C$, unless otherwise noted.

Supply Current vs. Supply Voltage

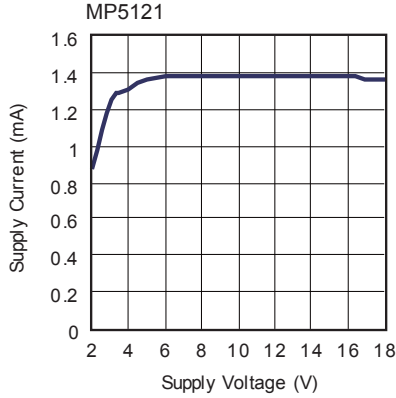

V_{OS} vs. V_{IN}

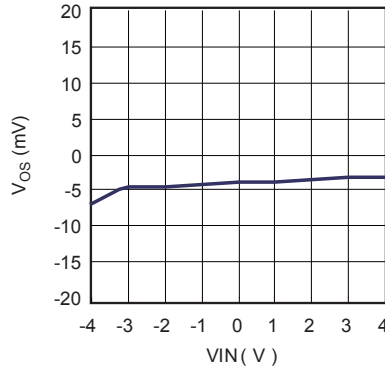

PSRR vs. Frequency

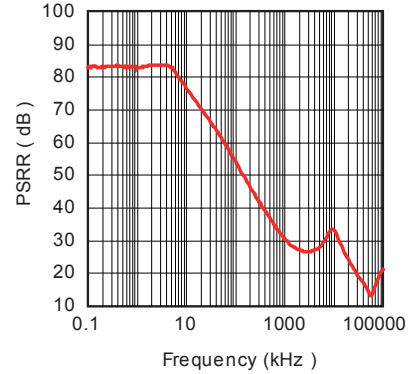

Open Loop

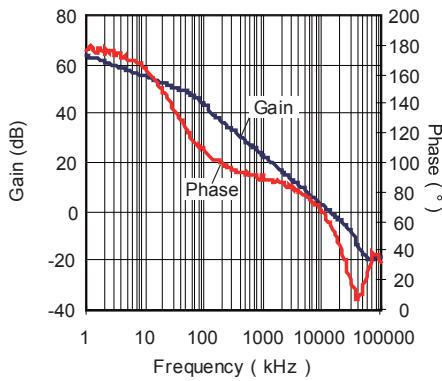

Closed Loop $A_v=1$

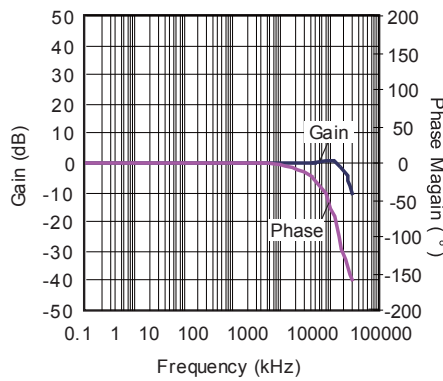

Closed Loop $A_v=2$

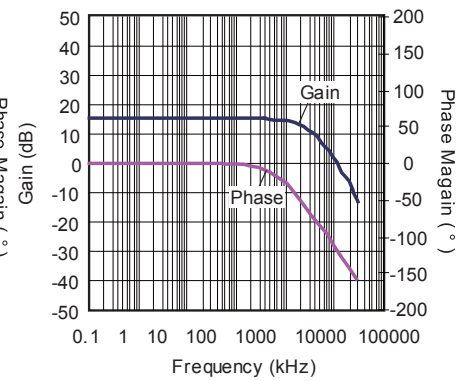

Frequency Response vs. C_L

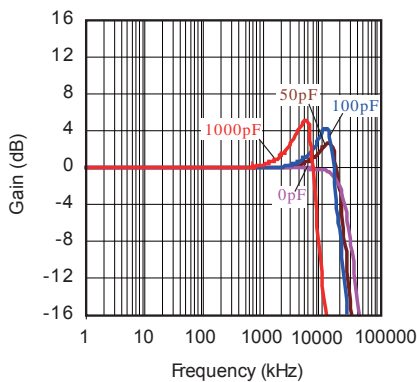

Frequency Response vs. R_L

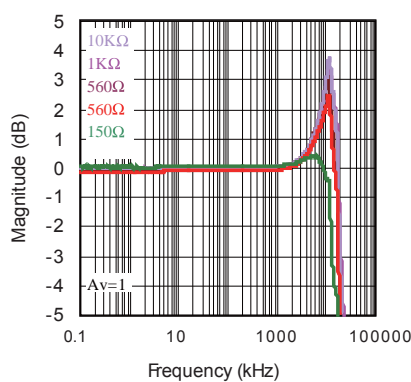

Output Noise vs. Frequency

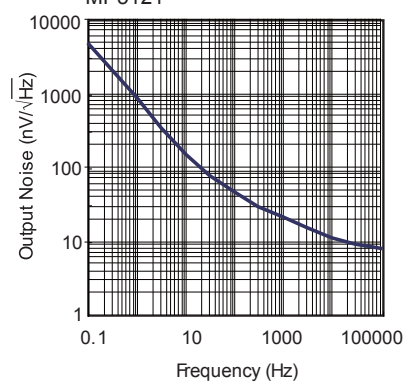

TYPICAL PERFORMANCE CHARACTERISTICS (continued)

$V_{S+}=5V$, $V_{S-}=-5V$, $R_L=10K\Omega$, $C_L=12pF$, $T_A=25^\circ C$, unless otherwise noted.

Small Signal Pulse Response
 $V_{S+}=+1.2V$, $V_{S-}=-1.2V$, $V_{IN}=\pm 0.1V$, $A_V=6$

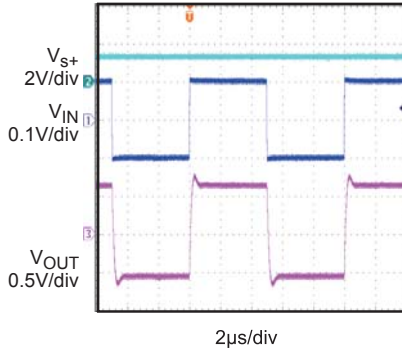

Small Signal Pulse Response
 $V_{S+}=+1.2V$, $V_{S-}=-1.2V$, $V_{IN}=\pm 0.1V$, $A_V=-5$

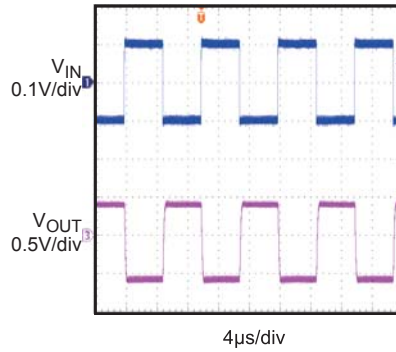

Small Signal Pulse Response
 $V_{IN}=\pm 50mV$, $A_V=+1$

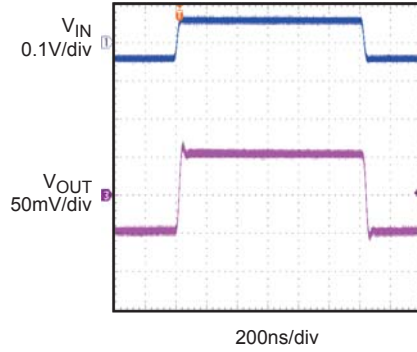

Rail to Rail Operation Response
 $V_{S+}=+1.2V$, $V_{S-}=-1.2V$, $V_{IN}=\pm 0.24V$, $A_V=-5$

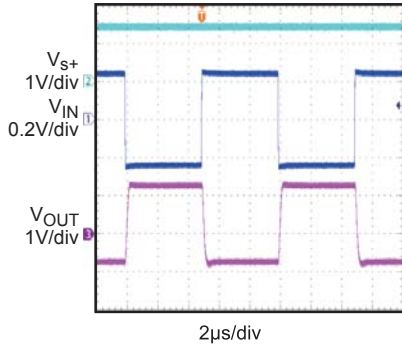

Small Signal Pulse Response
 $V_{IN}=\pm 0.8V$, $A_V=+6$

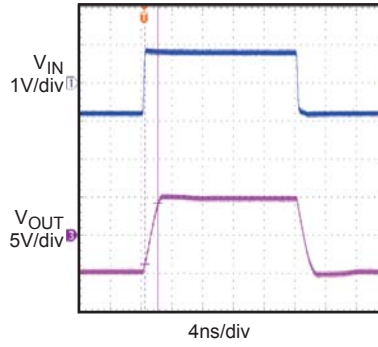

Large Signal Pulse Response
 $V_{IN}=\pm 3V$, $A_V=+1$

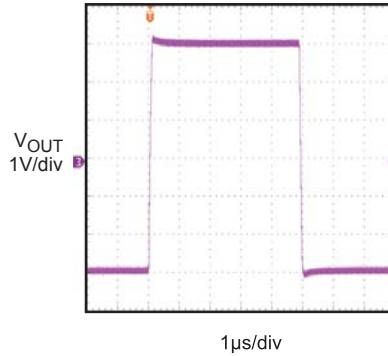

Rail to Rail Operation Response
 $V_{IN}=\pm 5V$, $A_V=1$

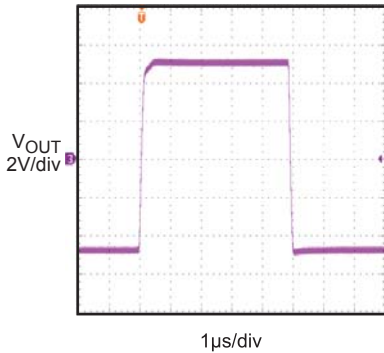

Rail to Rail Output Response
 $V_{S+}=+1.2V$, $V_{S-}=-1.2V$, $V_{IN}=\pm 0.22V$, $A_V=-5$

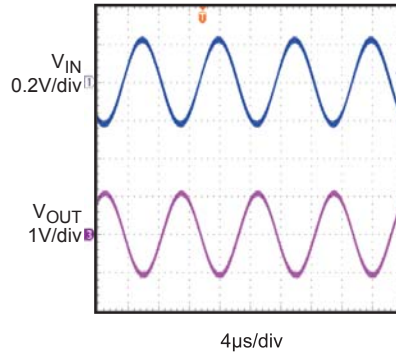

Rail to Rail Output Response
 $V_{S+}=+6V$, $V_{S-}=-6V$, $V_{IN}=\pm 1.2V$, $A_V=-5$

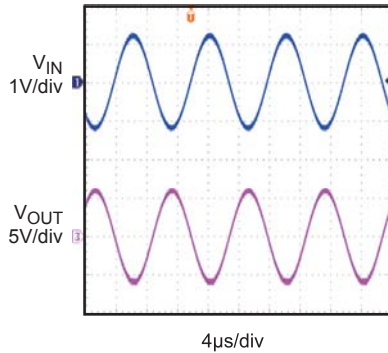

OPERATION DESCRIPTION

The MP5121/MP5221/MP5421 are high-speed, high slew rate, rail-to-rail input-output operational amplifiers. These devices can operate up to 50mA output current and 20MHz bandwidth.

INPUT

The MP5X21 can operate with inputs from rail to rail. It does this through the use of two differential pairs. A traditional PNP differential pair is used from 0.5V below the negative rail to 1V below the positive rail. At that point the input is switched to a NPN differential pair to operate up to 0.5V above the positive rail. The transition from one input differential pair to the other can cause distortion. Inputs near the rails can also cause distortion and degradation of other specifications.

OUTPUT

Current Rating

The MP5X21 can sink or source 50mA. It can provide high values of peak current, and much reduced value of average current. When the output voltages are near the rails the ability to provide current will be reduced.

Output Power

Make sure that the rms power is such that the die junction temperature will remain below 125°C

Power Requirements

The MP5X21 operates from a voltage supply, of $\pm V_s$ and ground, or from a V_s split supply. Single-ended voltage range is +3.2V to +20V.

PSRR and Noise

A common figure of merit is the PSRR (Power Supply Rejection Ratio). The PSRR is a measure of how much noise gets from the supply rails into the output. Notice that the PSRR falls with increasing frequency. In order to have good PSRR the ripple voltages and frequencies of the systems switching power supplies should be measured. If the PSRR is not acceptable, inductors can be inserted in series with the power supply rails to provide improved PSRR. Also make sure there are no transients created on the power supply lines when the MP5X21 load current changes suddenly. This can damage the part.

Transients

In addition to the ripple and noise on the power supplies, there are also transient voltage changes. This can be caused by another device on the same power supply suddenly drawing current or suddenly stopping a current draw. The design engineer should insure that there are no damaging transients induced on the power supply lines when the op amp suddenly changes current delivery.

LAYOUT

Ground Plane

Connect the opamp to a ground plane rather than ground traces for very low impedance. If this is not possible then make the ground traces as fat and short as possible.

Decoupling

High performance devices such as the MP5X21, with high slew rates and high currents, need large decoupling capacitors. These should be placed as close to the supply pins as possible. Use ground and power planes to make these decoupling capacitors as effective as possible. If that is not realistic then make the ground and power traces as thick and short as possible.

PACKAGE INFORMATION

TSOT23-5

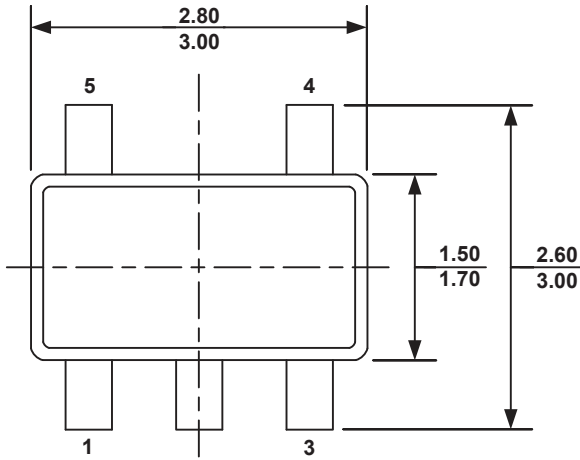

TOP VIEW

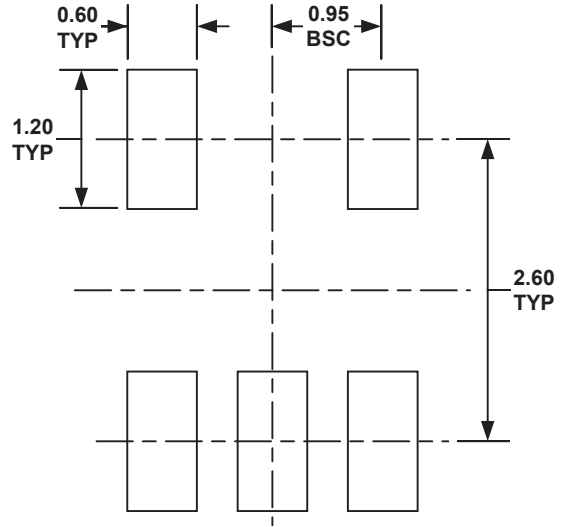

RECOMMENDED LAND PATTERN

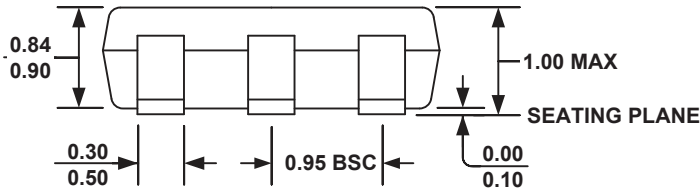

FRONT VIEW

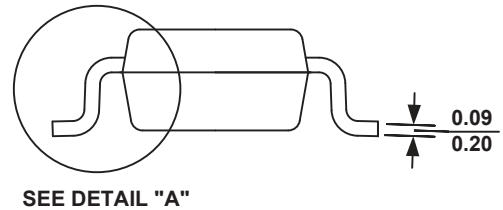

SIDE VIEW

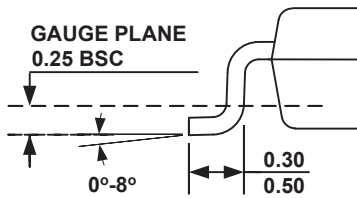

DETAIL A

NOTE:

- 1) ALL DIMENSIONS ARE IN MILLIMETERS.
- 2) PACKAGE LENGTH DOES NOT INCLUDE MOLD FLASH, PROTRUSION OR GATE BURR.
- 3) PACKAGE WIDTH DOES NOT INCLUDE INTERLEAD FLASH OR PROTRUSION.
- 4) LEAD COPLANARITY (BOTTOM OF LEADS AFTER FORMING) SHALL BE 0.10 MILLIMETERS MAX.
- 5) DRAWING CONFORMS TO JEDEC MO-193, VARIATION AA.
- 6) DRAWING IS NOT TO SCALE.

PACKAGE INFORMATION

MSOP8

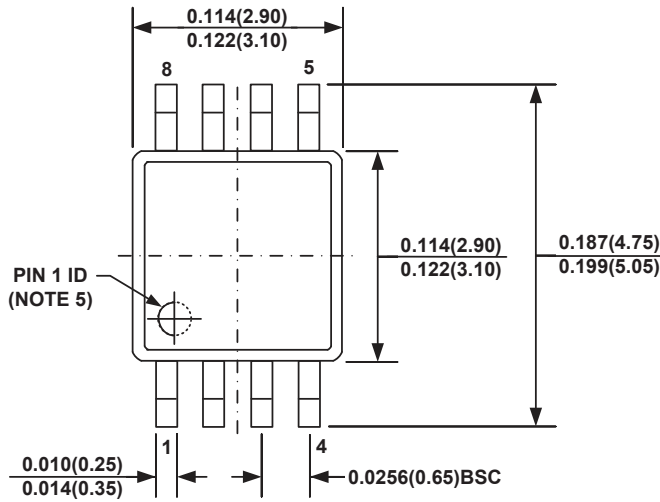

TOP VIEW

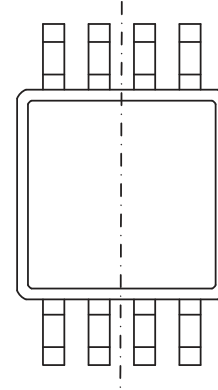

BOTTOM VIEW

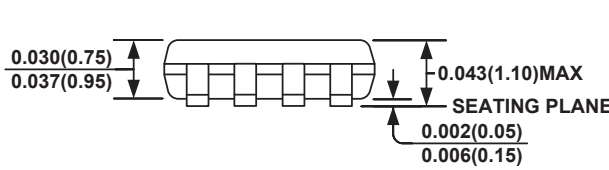

FRONT VIEW

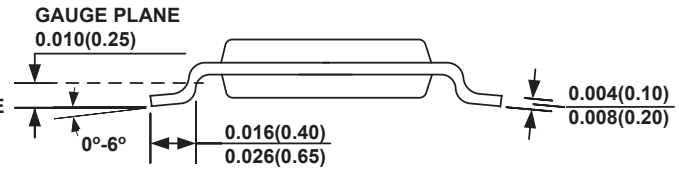

SIDE VIEW

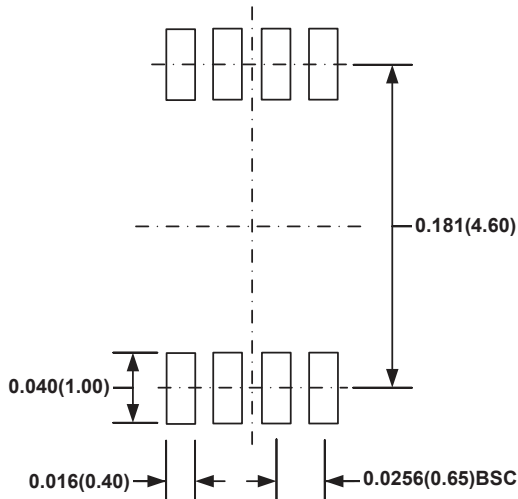

RECOMMENDED LAND PATTERN

NOTE:

- 1) CONTROL DIMENSION IS IN INCHES. DIMENSION IN BRACKET IS IN MILLIMETERS.
- 2) PACKAGE LENGTH DOES NOT INCLUDE MOLD FLASH, PROTRUSION OR GATE BURR.
- 3) PACKAGE WIDTH DOES NOT INCLUDE INTERLEAD FLASH OR PROTRUSION.
- 4) LEAD COPLANARITY (BOTTOM OF LEADS AFTER FORMING) SHALL BE 0.004" INCHES MAX.
- 5) PIN 1 IDENTIFICATION HAS HALF OR FULL CIRCLE OPTION.
- 6) DRAWING MEETS JEDEC MO-187, VARIATION AA.
- 7) DRAWING IS NOT TO SCALE.

PACKAGE INFORMATION

TSSOP14

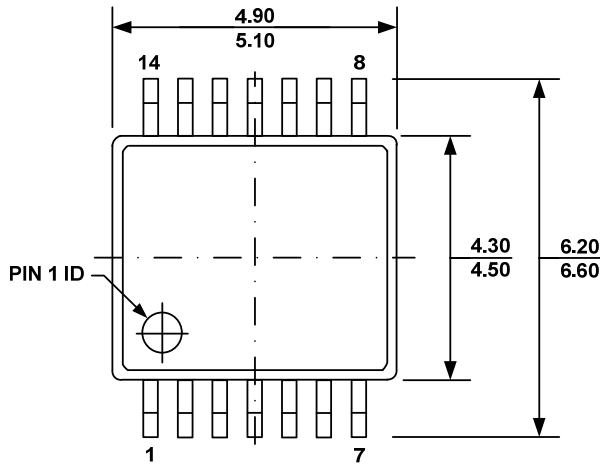

TOP VIEW

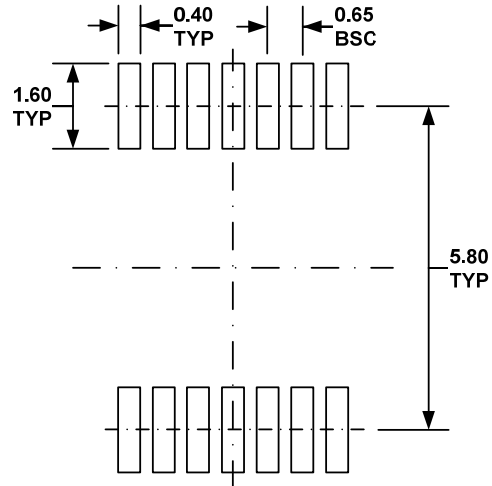

RECOMMENDED LAND PATTERN

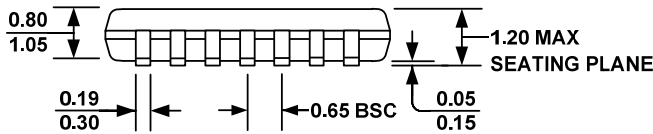

FRONT VIEW

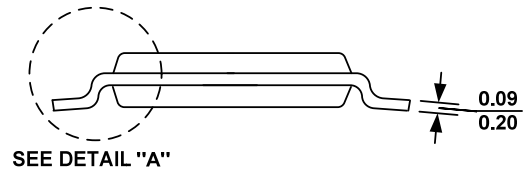

SIDE VIEW

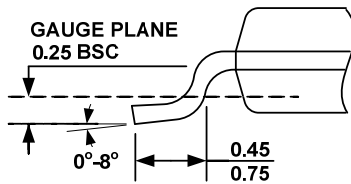

DETAIL "A"

NOTE:

- 1) ALL DIMENSIONS ARE IN MILLIMETERS.
- 2) PACKAGE LENGTH DOES NOT INCLUDE MOLD FLASH, PROTRUSION OR GATE BURR.
- 3) PACKAGE WIDTH DOES NOT INCLUDE INTERLEAD FLASH OR PROTRUSION.
- 4) LEAD COPLANARITY (BOTTOM OF LEADS AFTER FORMING) SHALL BE 0.10 MILLIMETERS MAX.
- 5) DRAWING CONFORMS TO JEDEC MO-153, VARIATION AB-1.
- 6) DRAWING IS NOT TO SCALE.

NOTICE: The information in this document is subject to change without notice. Please contact MPS for current specifications. Users should warrant and guarantee that third party Intellectual Property rights are not infringed upon when integrating MPS products into any application. MPS will not assume any legal responsibility for any said applications.