

# DLP®Products ECD 4K UHD EVM

## User's Guide



Literature Number: DLPU077A  
March 2019–Revised June 2019

---



---



---

<b>Preface</b> .....	<b>5</b>
<b>1 DLPDLR660TEVM, DLPDLR470TEVM and DLPLCRDC4422EVM Overview</b> .....	<b>6</b>
1.1 Welcome .....	6
1.2 What is in the DLPDLR660TEVM, DLPDLR470TEVM and DLPLCRDC4422EVM Evaluation Modules (EVMs)? .....	6
1.3 EVM Boards .....	8
1.4 Other Items Needed for Operation .....	9
1.5 DLPLCRDC4422EVM, DLPDLR470TEVM and DLPDLR660TEVM EVM Flex Cable .....	10
<b>2 Quick Start</b> .....	<b>11</b>
2.1 Downloading the Software .....	11
2.2 Connecting the DLPDLR660TEVM, or DLPDLR470TEVM, to the DLPLCRDC4422EVM .....	11
2.3 Powering-up the DLPLCRDC4422EVM and preparing for the DLPLCRDC4422EVM to be programmed.....	14
2.4 Programming the DLPLCRDC4422EVM and Displaying a SPLASH image .....	15
2.5 Troubleshooting .....	22
<b>3 Connections</b> .....	<b>23</b>
3.1 DLPLCRDC4422EVM Connections.....	23
3.1.1 Connectors .....	23
3.1.2 TestPoints .....	25
3.2 DLPDLR660TEVM Connections .....	27
3.2.1 Test Points .....	28
3.2.2 Connectors .....	28
3.3 DLPDLR470TEVM Connections .....	28
3.3.1 Test Points .....	30
3.3.2 Connectors .....	30
<b>4 Power Supply Requirements</b> .....	<b>31</b>
4.1 External Power Supply Requirements.....	31
<b>5 Safety</b> .....	<b>32</b>
5.1 Caution Labels.....	32
5.2 If You Need Assistance.....	32
<b>Revision History</b> .....	<b>33</b>

## List of Figures

1.	DLP DLPDLCR660TEVM and DLPLCRDC4422EVM Evaluation Module .....	5
1-1.	DLPLCRDC4422EVM .....	7
1-2.	DLPDLCR660TEVM .....	7
1-3.	DLPDLCR470TEVM .....	8
1-4.	EVM System Block Diagram .....	9
1-5.	Flex Cable Diagram .....	10
2-1.	Flex Cables on DLPDLCR660TEVM .....	12
2-2.	Flex Cables on DLPDLCR470TEVM .....	13
2-3.	EVMs Connected .....	14
2-4.	ON/OFF Switch .....	15
2-5.	DeVaSys Communication Configuration .....	16
2-6.	USB Communication Configuration .....	16
2-7.	Error Message .....	17
2-8.	Projector Control Menu .....	17
2-9.	Adding DLPC4422 Projector Control File .....	17
2-10.	Projector Control File for the Chosen Chipset .....	18
2-11.	DLPC4422 Projector Control Menu .....	18
2-12.	Loading the Flash Image .....	19
2-13.	Downloading Image unto the EVM .....	20
2-14.	Communication Between GUI and EVMs .....	20
2-15.	Splash Image Displayed on DMD .....	21
2-16.	USB Communication Error .....	22
2-17.	I2C communication error .....	22
2-18.	Programming Mode error .....	22
2-19.	Device programming delay increase .....	22
2-20.	Tool bar and panel display settings .....	22
3-1.	DLPLCRDC4422EVM Connectors (Top View) .....	23
3-2.	DLPDLCR660TEVM Test Points and Connectors .....	27
3-3.	DLPDLCR470TEVM Test Points and Connectors .....	29



## Read This First

---

---

### Trademarks

DLP is a registered trademark of Texas Instruments.

### About This Guide

This guide explains the hardware and software features of the DLP Products DLPDLCR660TEVM, DLPDLCR470TEVM and DLPLCRDC4422EVM systems. The EVM architecture and connectors will be described along with a quick start guide on how to operate the DLPDLCR660TEVM, DLPDLCR470TEVM and DLPLCRDC4422EVM EVMs using the DLPC4422 GUI. Specific DLP® chip details and operation can be found in related component documentation.

---

**NOTE:** Power supply, optics, illumination source, and cables are sold separately. See [Other Items Needed for Operation](#).

---



**Figure 1. DLP DLPDLCR660TEVM and DLPLCRDC4422EVM Evaluation Module**

### Related Documentation from Texas Instruments

DLP660TE Data Sheet: DLP660TE Digital Micromirror Device (DMD), [DLPS037](#)  
DLP470TE Data Sheet: DLP470TE Digital Micromirror Device (DMD), [DLPS037](#)  
DLPC4422 Data Sheet: DLPC4422 DLP Display Controller, [DLPS036](#)  
DLPA100 Data Sheet: DLPA100 Power Management and Motor Driver, [DLPS040](#)  
TPS65145 Data Sheet: TPS65145 Triple Output LCD Supply with Linear Regulator and Power, [DLPS053](#)

# ***DLPDLR660TEVM, DLPDLR470TEVM and DLPLCRDC4422EVM Overview***

---

---

---

## **1.1 Welcome**

The DLP Products DLPDLR660TEVM, DLPDLR470TEVM and DLPLCRDC4422EVM evaluation modules (EVMs) offer a reference design to enable faster development cycles for users of the DLPC4422 chips and allow evaluation of TI's DLP660TE and DLP470TE UHD chipsets. These consist of two DMD EVMs (DLPDLR660TEVM and DLPDLR470TEVM) and one controller EVM (DLPLCRDC4422EVM)

These evaluation kits bring together a set of components providing a great starting point to evaluate a UHD DLP system for:

- Laser TV
- Enterprise Projectors
- Digital Signage
- Gaming Machines
- Smart Projectors
- State Lighting Systems

## **1.2 What is in the DLPDLR660TEVM, DLPDLR470TEVM and DLPLCRDC4422EVM Evaluation Modules (EVMs)?**

The DLPDLR660TEVM, DLPDLR470TEVM and DLPLCRDC4422EVM are designed to be used in pairs. The DMD EVMs cannot be operated with the Controller EVM, DLPLCRDC4422EVM.

The DLPDLR660TEVM, which includes the DLP660TE display chip, and the DLPDLR470TEVM include the two flex cables required to connect to the DLPLCRDC4422EVM. DLPLCRDC4422EVM includes all circuitry required to drive the DLP660TE & DLP470TE display chip.

The DLPLCRDC4422EVM includes two DLPC4422 controllers in master-slave mode, two DLPA100s which serve as the power management and motor drivers, and other system circuitry such as the Vx1 receiver and system fan control.

The DLPLCRDC4422EVM can be programmed with either the DLP660TE or DLP470TE firmware which is available on the DLPC4422 product page. This firmware allows the DLPLCRDC4422EVM to drive either display chip. [Figure 1-1](#) and [Figure 1-2](#) show the top side of each EVM.

---

**NOTE:** [Figure 1-2](#) does not show the necessary flex cables needed to pair to DLPLCRDC4422EVM.

---

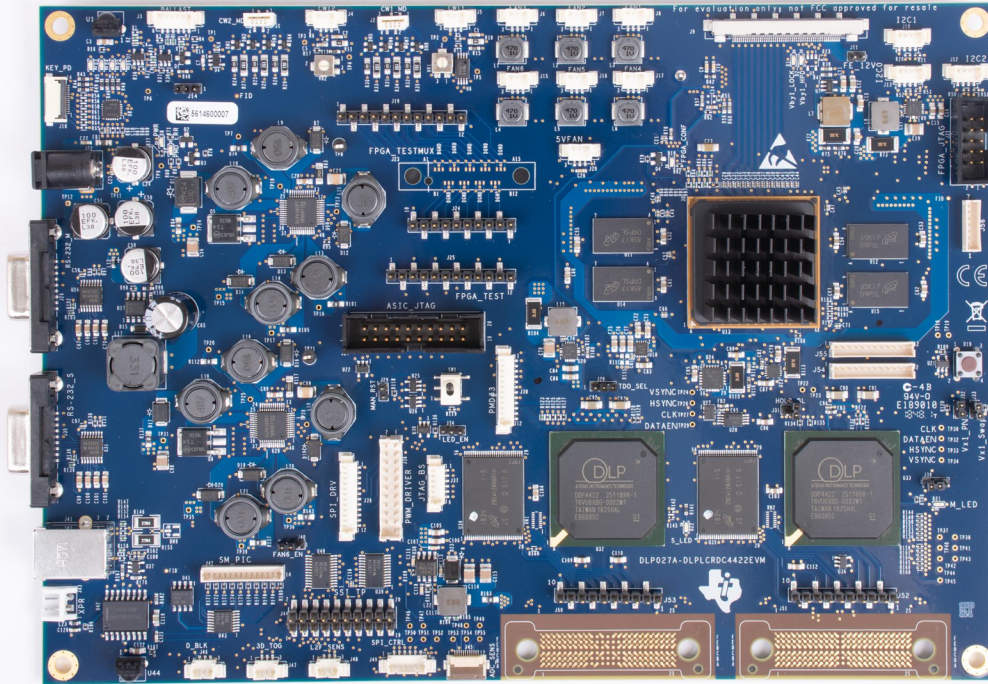

**Figure 1-1. DLPLCRDC4422EVM**

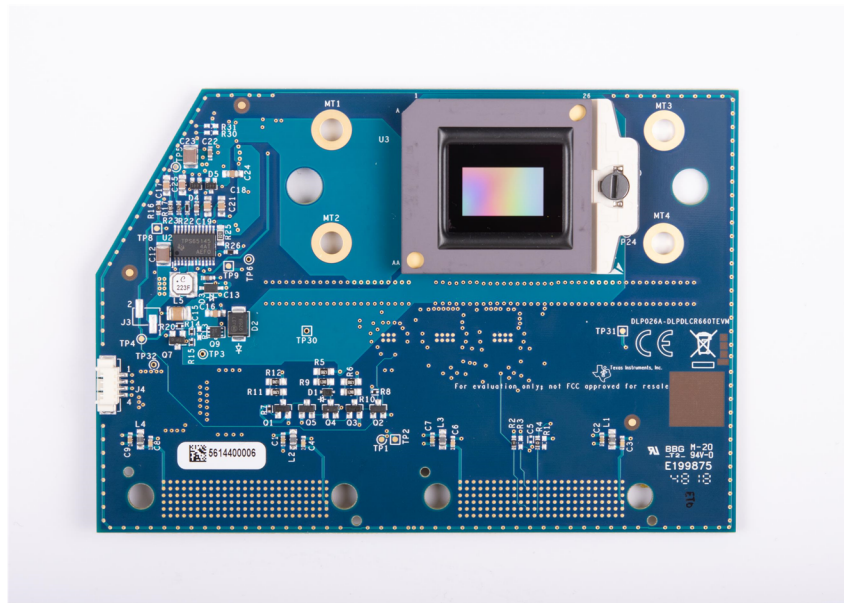

**Figure 1-2. DLPLCR660TEVM**

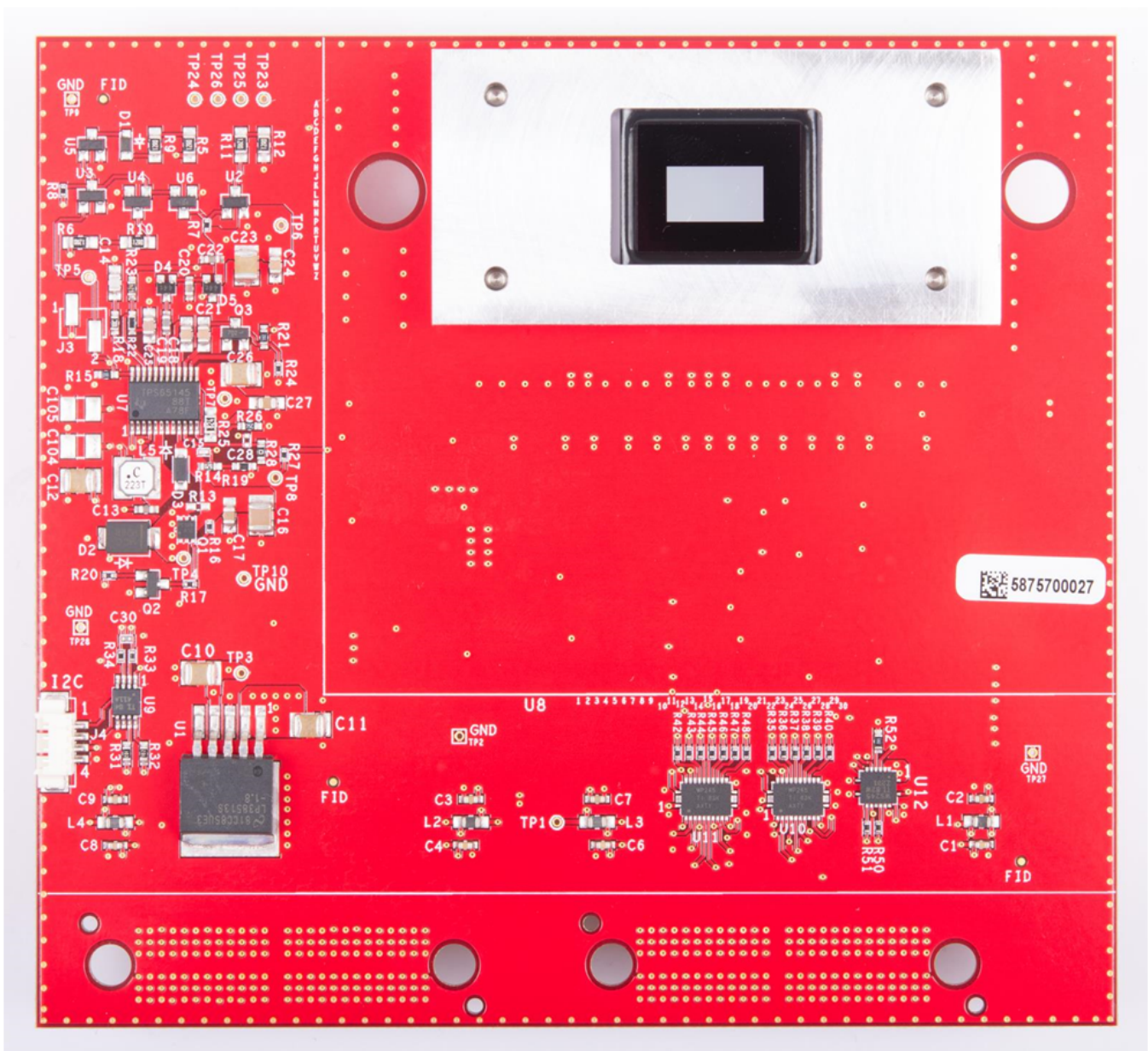

**Figure 1-3. DLPDLCR470TEVM**

### 1.3 EVM Boards

The DLPDLCR660TEVM, DLPDLCR470TEVM and DLPDLCRDC4422EVM EVMs contain the electronics required to drive either DLP660TE or DLP470TE DMD. The DLPLCRDC4422EVM offers several interface options for USB, I2C, and trigger inputs and outputs.

The system block diagram [Figure 1-4](#) details the functionality and control when using the DLPDLCR660TEVM and DLPDLCRDC4422EVM.



### 1.5 DLPLCRDC4422EVM, DLPDLCR470TEVM and DLPDLCR660TEVM EVM Flex Cable

Electrical malfunctions can occur by stressing the flex cable(s) connecting the DMD circuit board to the DLPLCRDC4422EVM controller circuit board. Stressing the flex cable can be caused by:

- Bending the cable outside the area identified in [Figure 1-5](#) (within 20.3 mm of connector plate centers).
- Repeatedly bending the flex cable(s) where the bend radius is less than 25.4 mm.
- A single bending of the flex cable(s) where the bend radius is less than 6.35 mm.

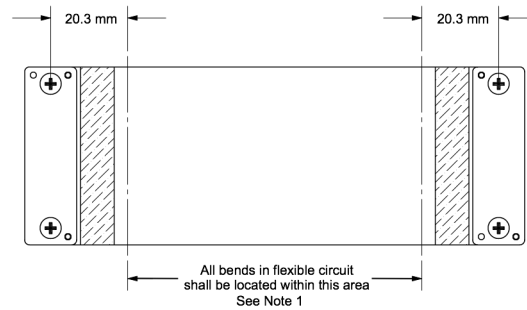

**Figure 1-5. Flex Cable Diagram**

---

**NOTE:** The minimum bend radius for forming flex cable (flexible) circuit is 6.35 mm  
Minimize any handline/movement on the flex cables during operation

---

Use caution when bending the flex cable to not exceed bending guidelines explained above.

## Quick Start

---

---

---

This chapter offers a quick start guide on how to connect the DLPDLCR660TEVM or DLPDLCR470TEVM to the DLPLCRDC4422EVM, how to power up the DLPLCRDC4422EVM, and how to program the DLPLCRDC4422EVM to display a SPLASH image on the DMD.

### 2.1 Downloading the Software

Before programming the DLPLCRDC4422EVM, ensure the DLPC4422 GUI and DMD firmware are both downloaded on the PC. The DLPC4422 GUI will allow for operation of the EVM and the DMD firmware is required so the DLPLCRDC4422EVM knows which DMD is being controlled. If the DLPDLCR660TEVM is being used with the DLPLCRDC4422EVM, the DLP660TE firmware is needed. Else if the DLPDLCR470TEVM is used, the DLP470TE firmware is needed.

The DLP660TE firmware and DLPC4422 GUI can be found under the “Tools and Software” tab on the product pages on TI.com. These are the product pages for the [DLP660TE](#), the [DLP470TE](#), and the [DLPC4422](#).

### 2.2 Connecting the DLPDLCR660TEVM, or DLPDLCR470TEVM, to the DLPLCRDC4422EVM

Before connecting the DLPDLCR660TEVM/DLPDLCR470TEVM to the DLPLCRDC4422EVM, locate the two flex cables that are packaged with either the DLPDLCR660TEVM/DLPDLCR470TEVM. Ensure the flex cables are not torn or damaged before connecting the DMD EVMs or the DLPLCRDC4422EVM.

The flex cables are exactly the same, meaning there is not a “right” or “left” cable. The cables are interchangeable, as long as the side of each cable labeled “DMD END” is connected to the DLPDLCR660TEVM/DLPDLCR470TEVM and the other end is connected to the DLPLCRDC4422EVM.

The steps for the connecting the EVMs are listed below:

1. Unscrew and remove the backer plate on each end of the flex cable.
2. Position the flex cable end which says “DMD END” to the backside of the DMD board.
3. Insert the two guide pins of the flex cable into the DMD board.
4. Using the guide pins, place one backer plate on the front side of the DMD board.
5. Screw the flex cable screws clockwise into the backer plate until nearly fully inserted
6. Take turns screwing in the screws so until each is lightly snug. Do not over-tighten.

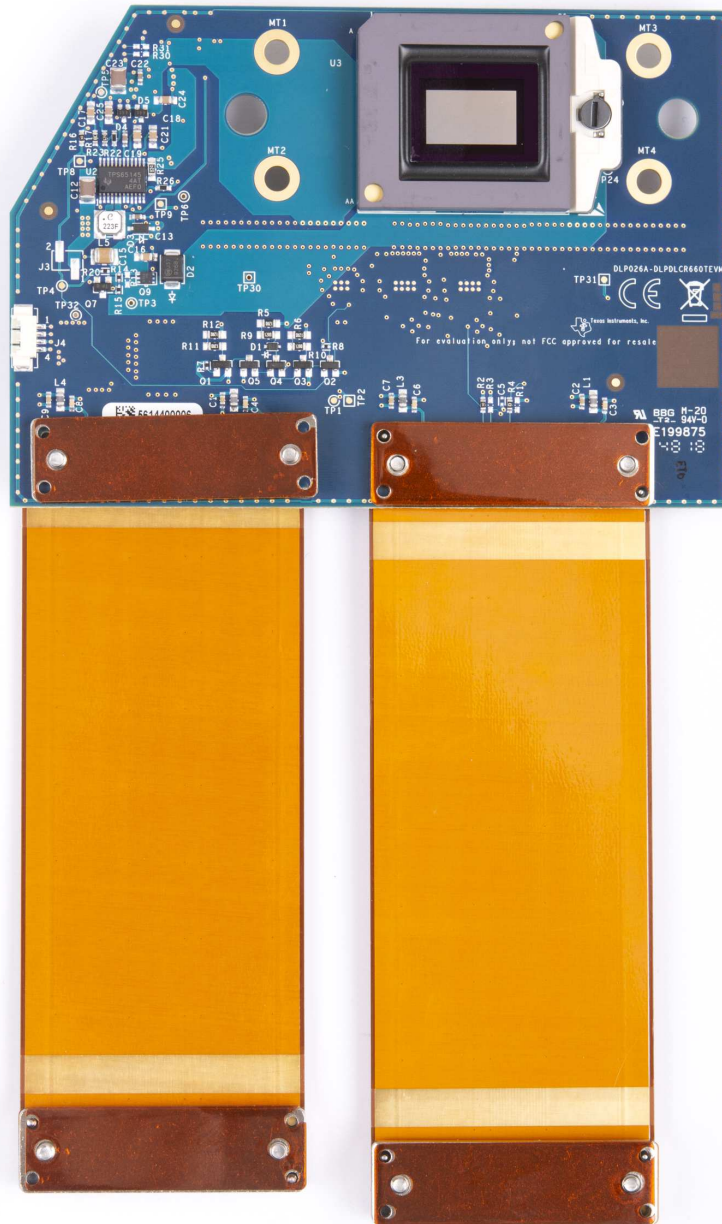

**Figure 2-1. Flex Cables on DLPDLCR660TEVM**

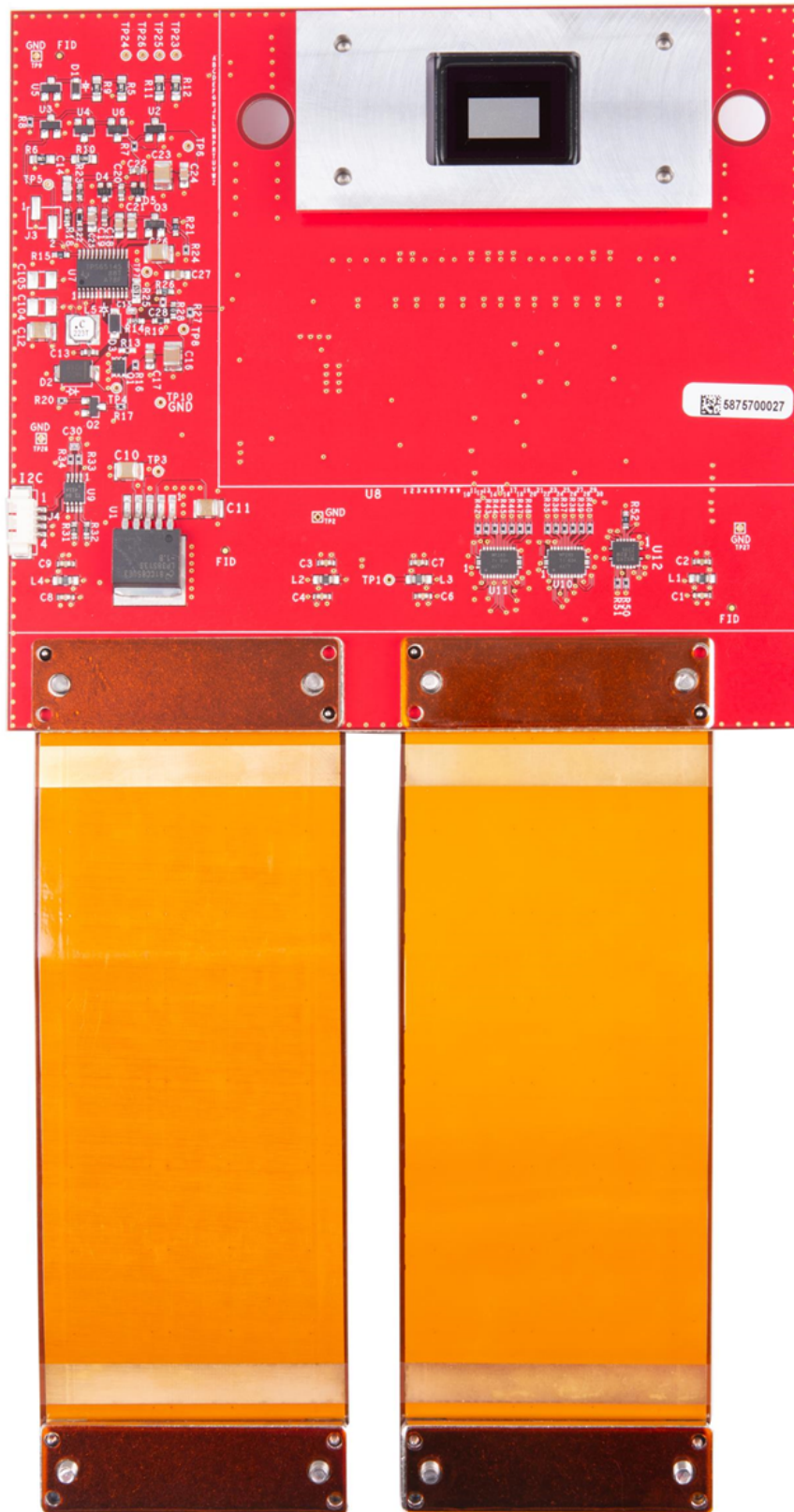

**Figure 2-2. Flex Cables on DLPDLCR470TEVM**

Repeat the above steps to connect the other end of each flex cable to the DLPLCRDC4422EVM. The EVM should look like after the flex cables have been connected to both the DLPDLR660TEVM and the DLPLCRDC4422EVM. The process is the same for use with the DLPDLR470TEVM.



Figure 2-3. EVMs Connected

### 2.3 Powering-up the DLPLCRDC4422EVM and preparing for the DLPLCRDC4422EVM to be programmed

Before powering up the EVM, ensure the included DLPLCRDC4422EVM jumpers are in the correct positions. The jumper locations are listed in [Section 3.1.1](#).

Table 2-1. Reference Designators

Jumper	Description (Bold Indicates Default Position)
J11 - Front End 12V	<b>Uninstalled - Main Board is Powered From its Own AC Adaptor</b> Installed - Front End Board Provides Power to Main Board
J14 - Blue LED enable or Lamp Ballast	Pins 1,2 connected Blue LED Enable <b>Pins 2,3 connected Lamp Mode</b>
J28 - TDO1 or TDO2	Pins 1,2 connected TDI in to slave is from TDO1 from Master <b>Pins 2,3 connected TDI in to slave is from TDO2 from Master</b>
J29 - Manual Reset	<b>Uninstalled - Normal Operation</b> Installed - Hold in Reset
J31 - Hold in Boot Loader	<b>Uninstalled - Normal Operation</b> Installed - Hold in Boot Loader

**Table 2-1. Reference Designators (continued)**

Jumper	Description (Bold Indicates Default Position)
J32 - Vx1 Swap P/N	Uninstalled - Swapping P and N <b>Installed - Not Swapping P and N</b>
J33 - Vx1 Swap Bit Order	Uninstalled - Swapping Bit Order <b>Installed - Not Swapping Bit Order</b>
J34 - LED Enable Invert	Pins 1,2 connected LED_EN inverted Pins 2,3 connected LED_EN not inverted
J38 - Light to Frequency Sensor or ADC Integrating Sensor	<b>Pins 1,2 connected ADC Integrating Sensor</b> Pins 2,3 connected Comparator Sensor
J40 - High Current Fan 5 or Fan 6	Pins 1,2 connected for High Current Fan 5 <b>Pins 2,3 connected for Fan 6</b>

Jumper J31 is the “Hold BL” jumper. This jumper is used to put the DLPLCRDC4422EVM into boot loader mode, which allows the DLPC4422 controllers to be programmed. Connect this jumper to prepare the DLPLCRDC4422EVM to be programmed.

To power up the DLPLCRDC4422EVM, a 12V, 5A power supply is needed. Ensure the power supply is functional and the switch SW1 on the EVM is set to off before connecting the power supply to the EVM. Connecting the power supply when the switch is in the off position may prevent damage to the DLPLCRDC4422EVM from poor power connections. The image below shows SW1 in the on position.

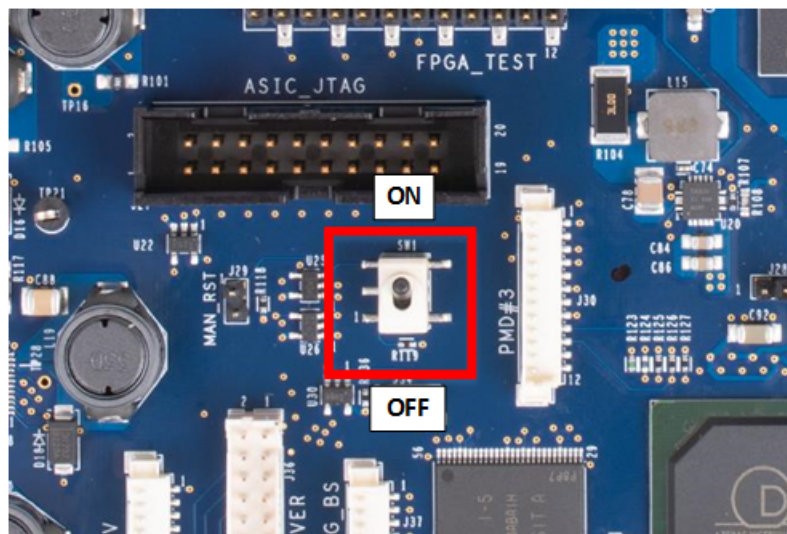
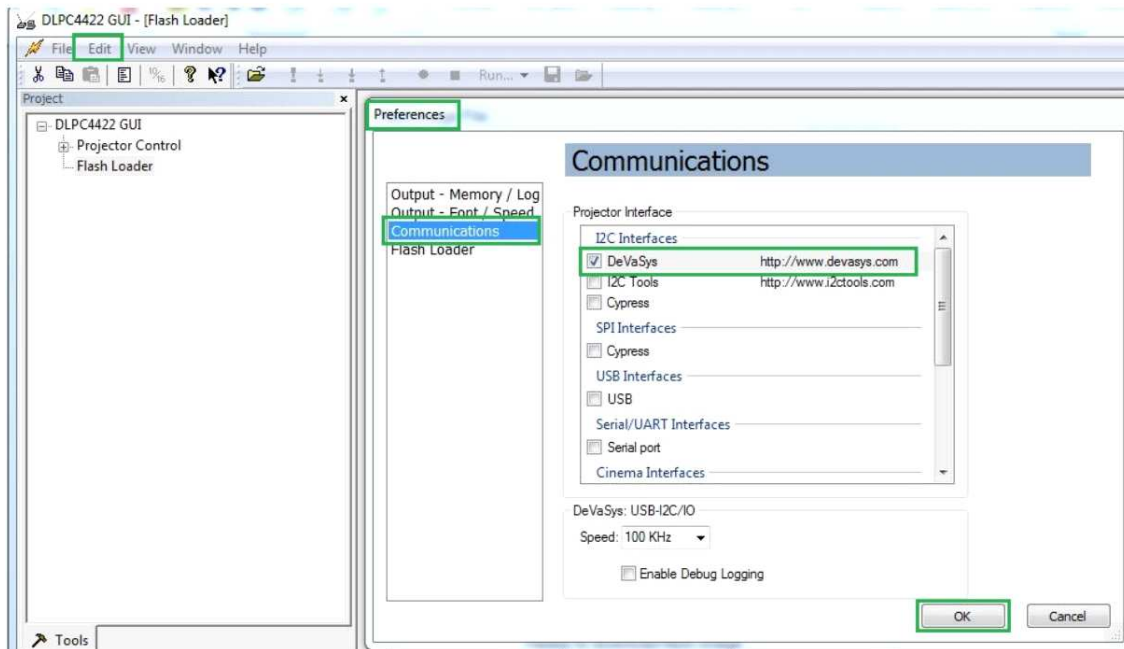

**Figure 2-4. ON/OFF Switch**

Once the power supply has been connected to the DLPLCRDC4422EVM, the switch SW1 can be flipped to the “on” position. You can then plug in the USB cable into the board to prepare for programming the board.

## 2.4 Programming the DLPLCRDC4422EVM and Displaying a SPLASH image

Follow these steps in order to download and configure the DLPC4422 GUI.:

1. Download and install the DLPDLCR660TEVM Firmware SW package. The Projector Control (.projector) and Firmware binary(.img) files will be located in the install directory. The same procedure applies to the DLPDLCR470TEVM with the appropriate firmware.
2. Setting up Communication Preferences:
  - a. DLPC4422 GUI supports USB and I2C communication. To change these settings, please go to Edit- >Preferences->Communication.



**Figure 2-5. DeVaSys Communication Configuration**

- b. For USB, please select the USB interface. Note: USB is the preferred method to download the firmware flash image to the projector as it is much faster than I2C.

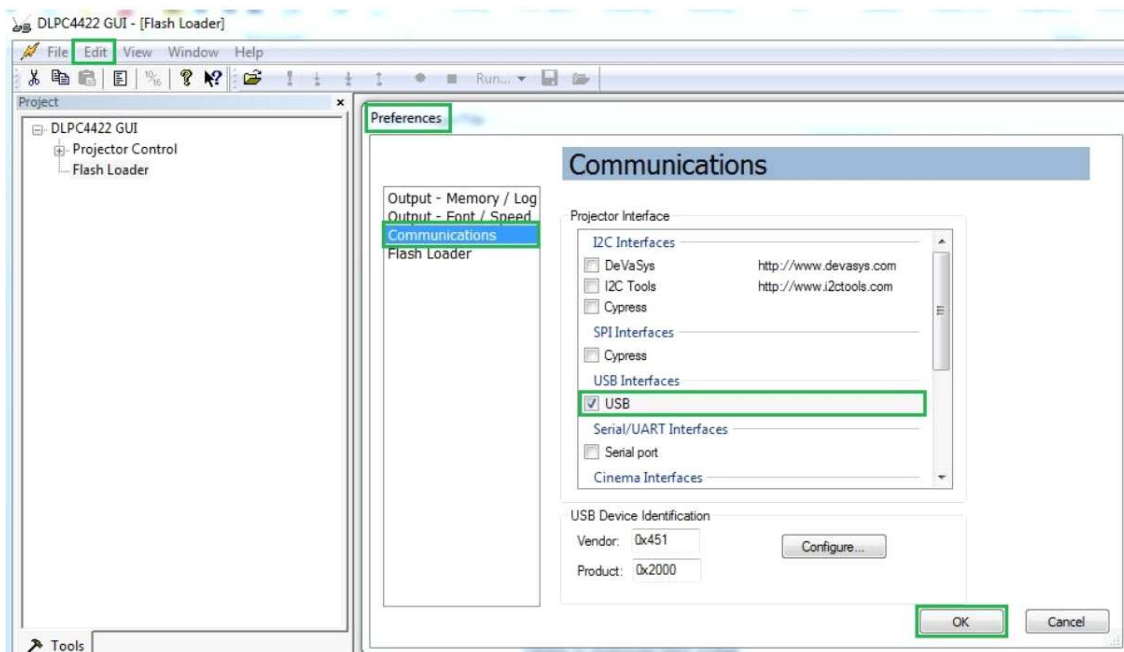

**Figure 2-6. USB Communication Configuration**

- c. An error message may appear saying the USB driver cannot be opened. This is expected, as we have not yet enabled communication on the board. Click “OK” on this error.

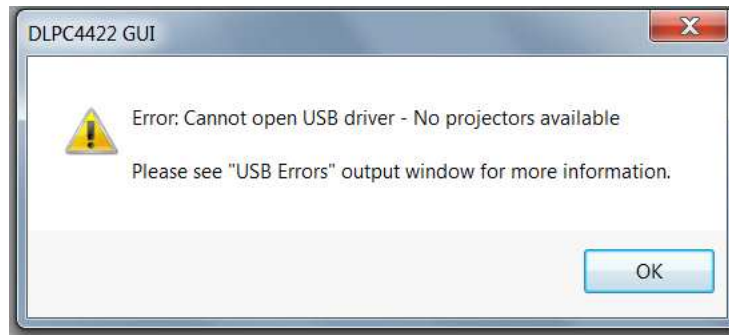

Figure 2-7. Error Message

3. Projector Control Configuration:
  - a. Run the DLPC4422 GUI tool and select the Projector Control sub-tool



Figure 2-8. Projector Control Menu

- b. Select Open Projector File then select Add. Navigate to the .projector file location installed in step 1

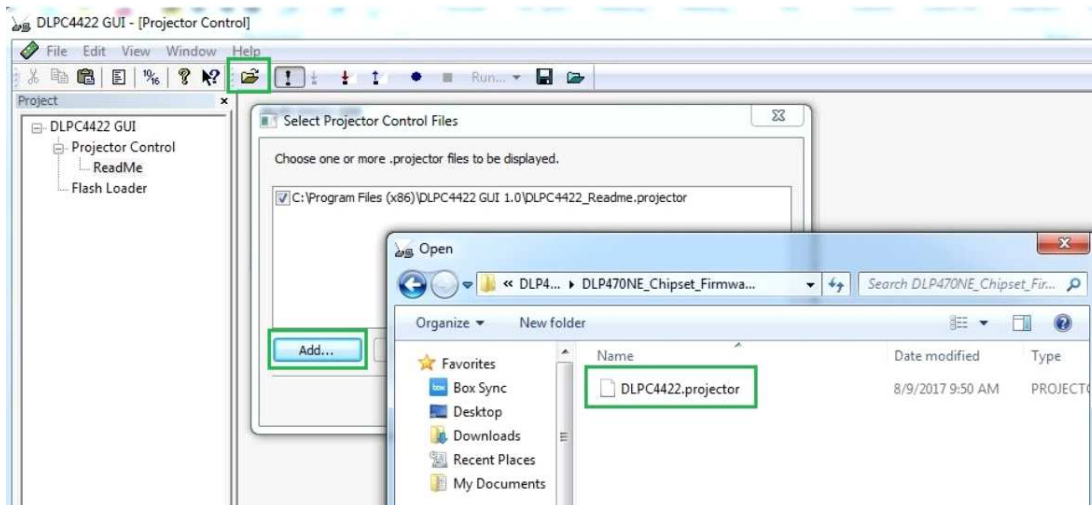

Figure 2-9. Adding DLPC4422 Projector Control File

- c. Ensure the desired Projector Control file is checked, then select OK. Note: If you want to use one Projector Control file at a time, please deselect the files you do not want to see before selecting OK.

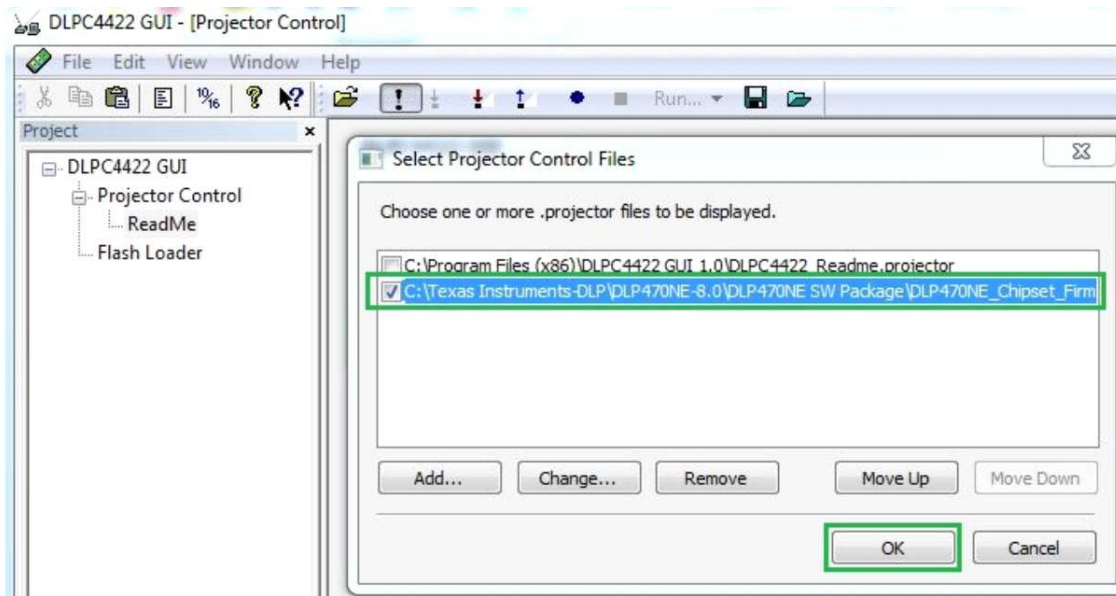

Figure 2-10. Projector Control File for the Chosen Chipset

d. Once this file is loaded, you can navigate through its pages to control a DLPC4422 controller.

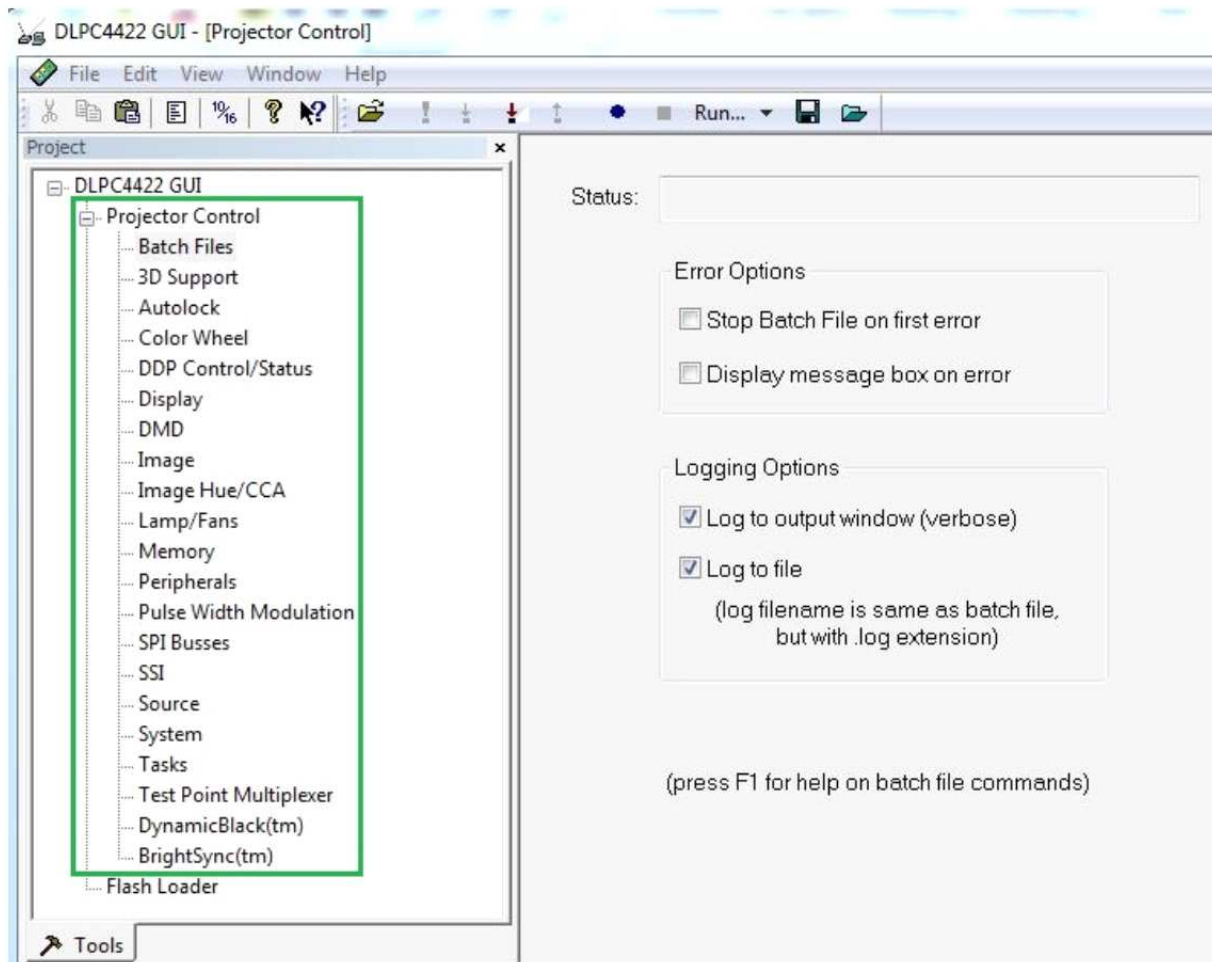
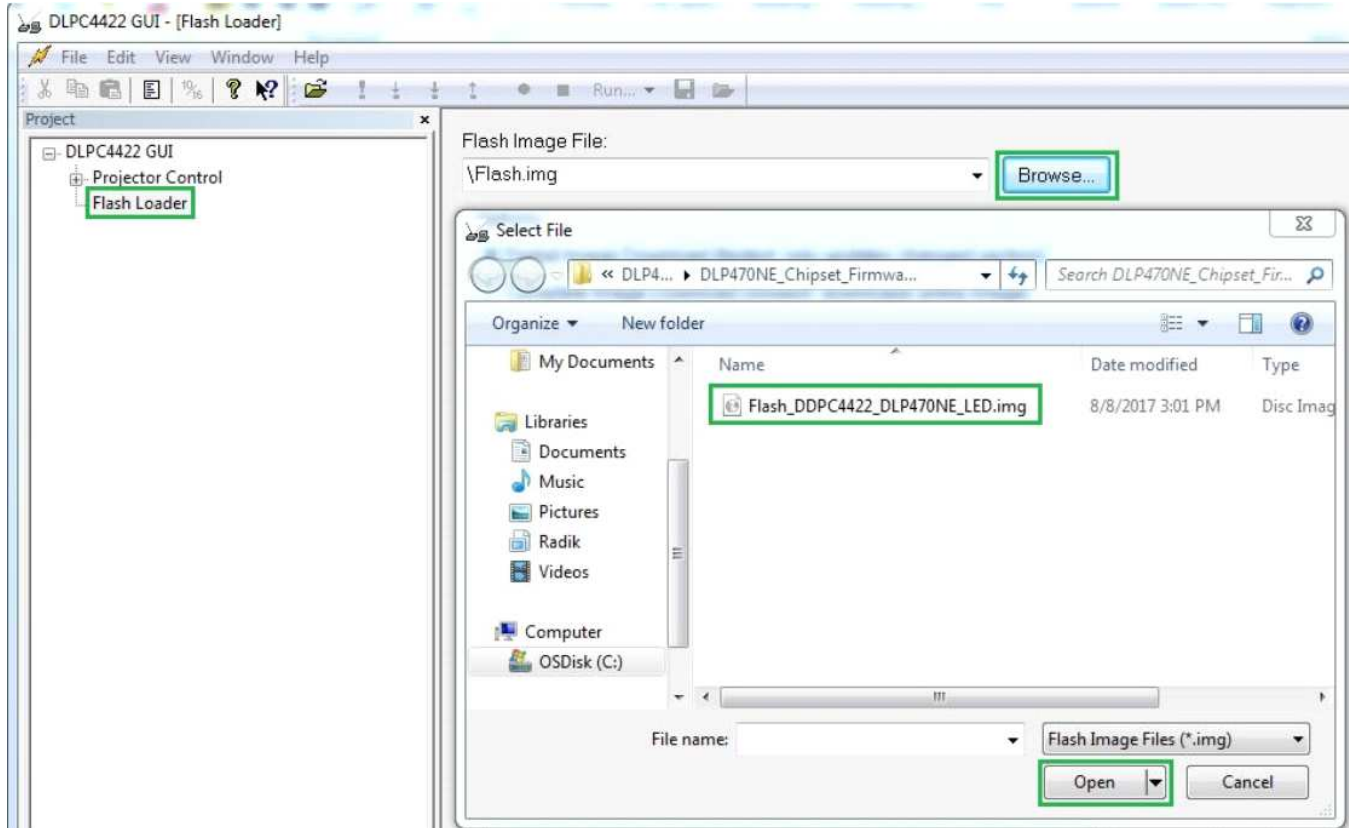

Figure 2-11. DLPC4422 Projector Control Menu

4. Flash Loader Configuration:

- a. Select the Flash Loader sub-tool, and then select the Browse button. The default location after downloading the EXE file should be “C:\Texas Instruments-DLP\DLP660TE-8.1\SW V8.1\DLP660TE\_Chipset\_Firmware\_v8.1”. After navigating to this directory, select the “Flash\_DUAL\_DLPC4422\_DLP660TE\_LED.img” file and click on "open".



**Figure 2-12. Loading the Flash Image**

- b. Select Complete Image Download for first time download. The flash should have the boot loader pre-loaded; uncheck the Skip Boot Loader Area. Check this only if you need to upgrade the bootloader.

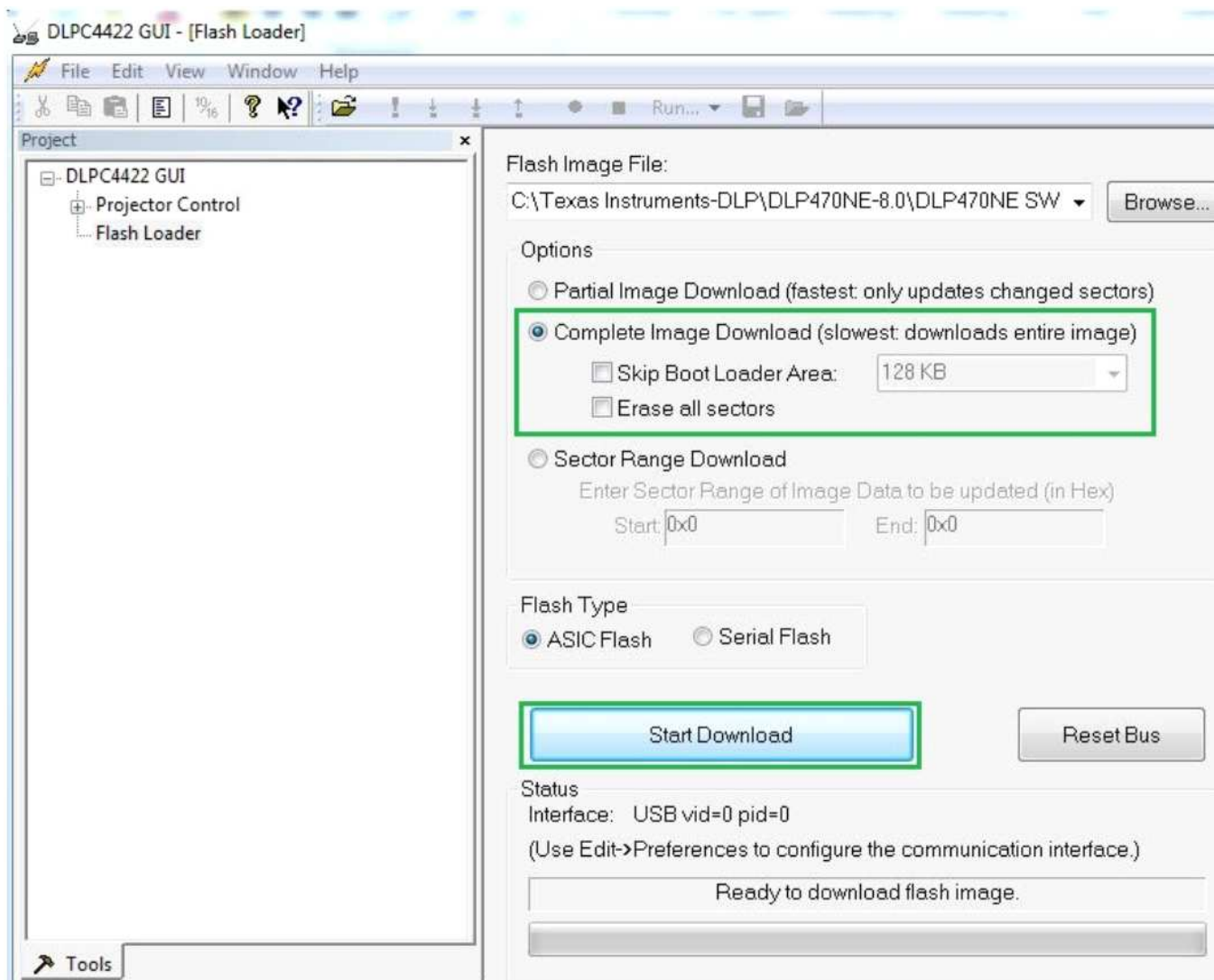

**Figure 2-13. Downloading Image into the EVM**

- c. 7. Connect DLPLCRDC4422EVM to PC via USB. Ensure USB communication capability by clicking “Reset Bus” on the bootloader menu in the DLPC4422 GUI. The “Status” field should look as follows:

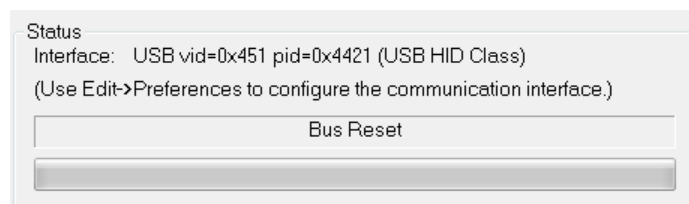
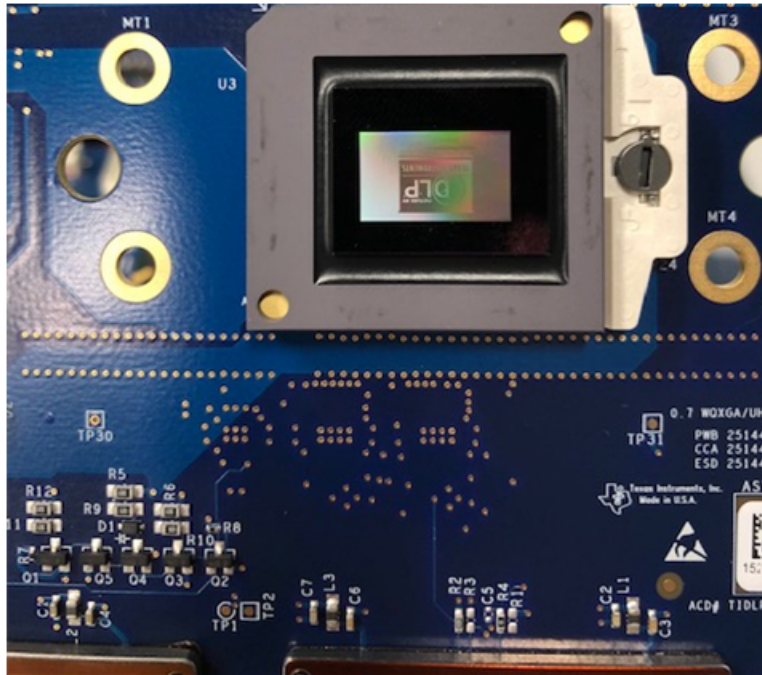

**Figure 2-14. Communication Between GUI and EVMs**

**NOTE:** If there is an issue with USB communication, turn off DLPLCRDC4422EVM and disconnect then reconnect USB cable and power on board.

- d. Select Start Download to begin.
- e. Click “Start Download”. The loading process should take between 5 and 10 minutes.

- f. After the download has completed, switch SW1 to “off” and switch the power to the UUT off. Remove the jumper on J31 from the DLPLCRDC4422EVM board.
- g. After removing the jumper, re-enable power to the DLPLCRDC4422EVM. Switch SW1 to the “On” position. A Red LED should appear after a few seconds. The Red LED will shut off and a green LED will begin blinking. After the blinking LED appears, the DLP Texas Instruments logo should be visible on the DMD for a few seconds. The DMD should appear as follows:



**Figure 2-15. Splash Image Displayed on DMD**

Turn the switch back to the “off” position before connecting the USB cable to DLPLCRDC4422EVM. The power supply does not have to be disconnected before connecting the USB cable. Once the USB cable is connected to the DLPLCRDC4422EVM (and the PC), turn the switch on the DLPLCRDC4422EVM to the “on” position.

## 2.5 Troubleshooting

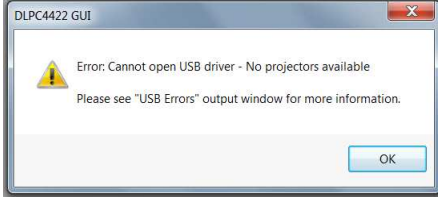
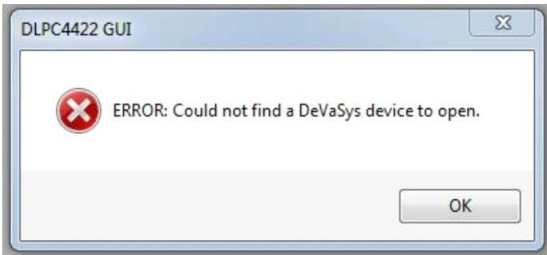
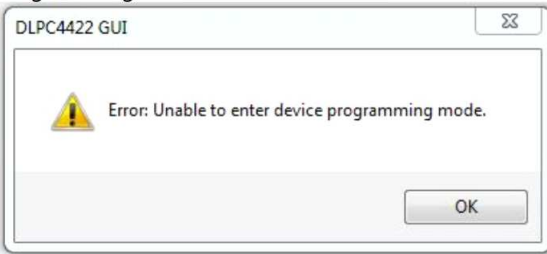
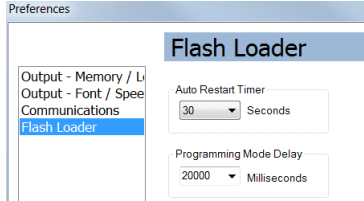
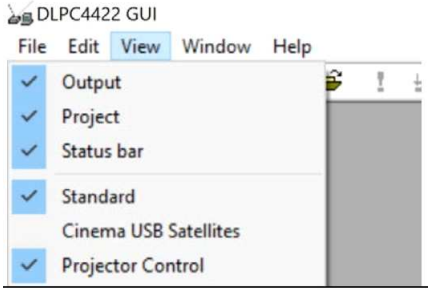
Problem	Possible solutions
<p style="text-align: center;">USB Communication Error</p>  <p style="text-align: center;"><b>Figure 2-16. USB Communication Error</b></p>	<p>Verify the correct communication settings have been applied. Ensure the USB cable is connected both to the projector and computer.</p>
<p style="text-align: center;">I2C communication error</p>  <p style="text-align: center;"><b>Figure 2-17. I2C communication error</b></p>	<p>Verify the correct communication settings have been applied. Ensure a DeVasys box and the appropriate USB and I2C cables are connected.</p>
<p style="text-align: center;">Programming Mode error</p>  <p style="text-align: center;"><b>Figure 2-18. Programming Mode error</b></p>	<p>Please check your connection settings and try again. Note: If this occurs only occasionally, increase the programming delay to 20000ms.</p>  <p style="text-align: center;"><b>Figure 2-19. Device programming delay increase</b></p>
<p style="text-align: center;">Tool bars or panels missing</p>	 <p style="text-align: center;"><b>Figure 2-20. Tool bar and panel display settings</b></p>

# Connections

This chapter introduces all the connections and test points available on the DLPLCRDC4422EVM and DLPDLCR660TEVM.

## 3.1 DLPLCRDC4422EVM Connections

Figure 3-1 depicts the switches and connectors with their respective locations. Note that neither cables nor the power supply is included with the module.

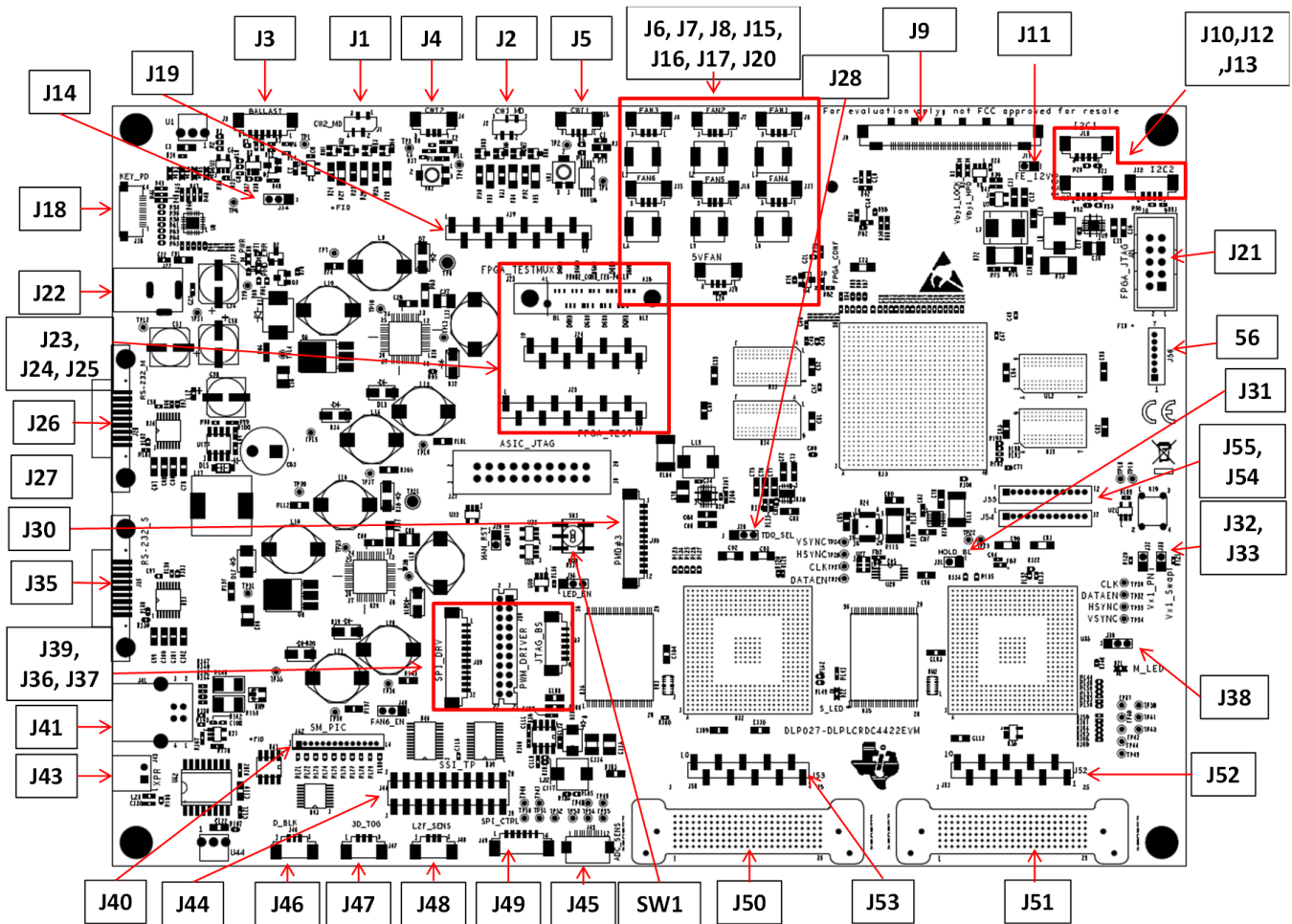

**Figure 3-1. DLPLCRDC4422EVM Connectors (Top View)**

### 3.1.1 Connectors

1. **J1** – Colorwheel #2 motor drive
2. **J2** – Colorwheel #1 motor drive

3. **J3** – Lamp Ballast Control
4. **J4** – Colorwheel #2 Index Sensor
5. **J5** – Colorwheel #1 Index Sensor
6. **J6** – Fan #3
7. **J7** – Fan #2
8. **J8** – Fan #1
9. **J9** – V-By-One Input
10. **J10** – I2C1 Bus
11. **J11** – FE\_12V
12. **J12** – I2C2 Bus
13. **J13** – I2C0 Bus
14. **J14** - Blue\_LED\_EN / Lamp Mode
15. **J15** - FAN #6
16. **J16** - FAN #5
17. **J17** - FAN #4
18. **J18** - Keyboard Interface
19. **J19** - FPGA Testmux Header
20. **J20** - 5V Fan
21. **J21** – FPGA\_JTAG
22. **J22** - 12V Input
23. **J23** - FPGA Testmux
24. **J24** - FPGA Testmux Header
25. **J25** - FPGA Test Points
26. **J26** - RS\_232\_M (Master)
27. **J27** - ASIC JTAG
28. **J28** - JTAG TDO1/2 Bus Selection
29. **J29** - Manual Reset Jumper
30. **J30** - Optional DLP1000 #3 Header
31. **J31** - HOLD\_BL
32. **J32** – Vx1 Swap PN
33. **J33** – Vx1 Swap Bit Order
34. **J34** - LED\_EN
35. **J35** - RS\_232\_S (Slave)
36. **J36** - PWM SSI Driver I/F
37. **J37** - JTAG Boundary Scan
38. **J38** – ADC Sensor Interface
39. **J39** - SPI Driver and Control I/F
40. **J40** – FAN6\_EN
41. **J41** – Mini-USB
42. **J42** –SM\_PIC (Actuator Test Points)
43. **J43** - XPR
44. **J44** – SSI\_TSP
45. **J45** – ADC Integrating Sensor Board I/F
46. **J46** – D\_BLK
47. **J47** – 3D\_TOG

48. **J48** – L2F\_Sens
49. **J49** – SSI SPI Control
50. **J50** – Flex Cable Connector
51. **J51** – Flex Cable Connector
52. **J52** – 4422 (Master) Testpoints
53. **J53** – 4422 (Slave) Testpoints
54. **J54** - Actuator Interface
55. **J55** - Actuator Interface
56. **J56** - Actuator Interface

### 3.1.2 TestPoints

1. **TP1** - LAMPLITZ\_FLTR
2. **TP2** - CW1 Sense Input
3. **TP3** - CW2 Sense Input
4. **TP4** - CW\_INDEX2
5. **TP5** - CW\_INDEX1
6. **TP6** - LMPCTRL
7. **TP7** - P5V\_M
8. **TP8** - GND
9. **TP9** - P12V
10. **TP10** - A1P8V\_M
11. **TP11** - P12V
12. **TP12** - GND
13. **TP13** - CW\_PWM1
14. **TP14** - P1P1V\_M
15. **TP15** - P1P8V\_M
16. **TP16** - P3P3V\_M
17. **TP17** - P2P5V\_M
18. **TP18** - ACT\_SYNC\_0
19. **TP19** - ACT\_SYNC\_1
20. **TP20** - P5V\_S
21. **TP21** - GND
22. **TP22** - EXT\_ARSTZ
23. **TP23** - MTR\_ARSTZ
24. **TP24** - S\_P1\_VSYNC
25. **TP25** - A1P8V\_S
26. **TP26** - S\_P1\_HSYNC
27. **TP27** - S\_P\_CLK1
28. **TP28** - CW\_PWM2
29. **TP29** - S\_P\_DATAEN1
30. **TP30** - M\_P\_CLK1
31. **TP31** - P1P1V\_S
32. **TP32** - M\_P\_DATAEN1
33. **TP33** - M\_P1\_HSYNC
34. **TP34** - M\_P1\_VSYNC
35. **TP35** - P1P8V\_S

36. **TP36** - P3P3V\_S
37. **TP37** - SSP0\_CSZ0
38. **TP38** - DADSTB
39. **TP39** - P2P5V\_S
40. **TP40** - SSP0\_CSZ1
41. **TP41** - SSP0\_RXD
42. **TP42** - SSP0\_CSZ2
43. **TP43** - A\_SSP0\_CLK
44. **TP44** - SSP0\_CSZ3
45. **TP45** - A\_SSP0\_TXD
46. **TP46** - LED\_SCLK
47. **TP47** - LED\_DIN
48. **TP48** - ADC\_SCLK
49. **TP49** - ADC\_SDO
50. **TP50** - LED\_DOUT
51. **TP51** - LED\_OE
52. **TP52** - LED\_DIR
53. **TP53** - ADC\_RST
54. **TP54** - ADC\_SDIN
55. **TP55** - ADC\_CSZ
56. **TP500** - GND

### 3.2 DLPDLCR660TEVM Connections

Figure 3-2 depicts the switches and connectors with their respective locations.

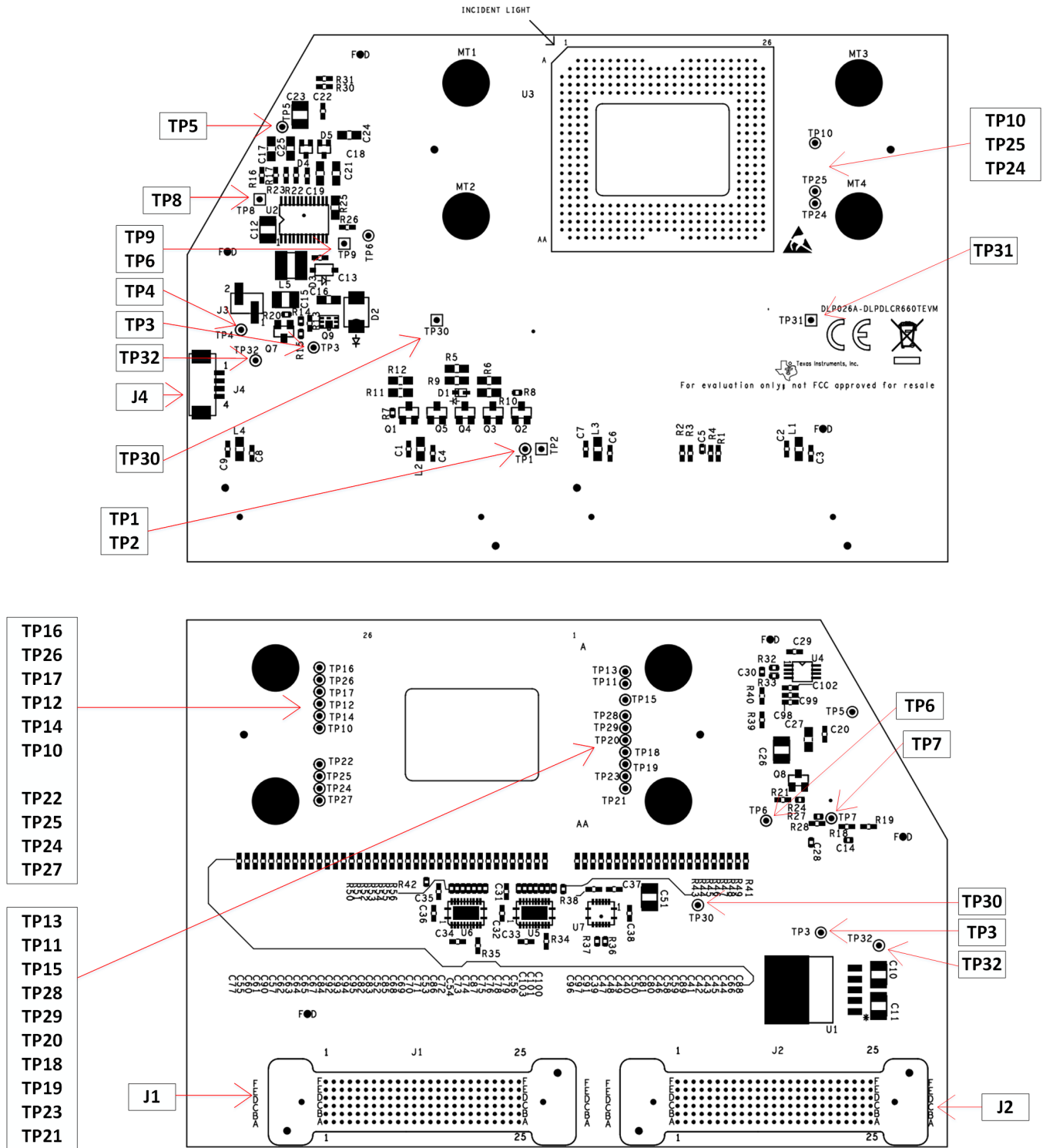

Figure 3-2. DLPDLCR660TEVM Test Points and Connectors

### 3.2.1 Test Points

1. **TP1** - DMD\_P3P3V
2. **TP2** - GND
3. **TP3** - VOFFSET
4. **TP4** - EN\_OFFSET
5. **TP5** - VRESET
6. **TP6** - VBIAS
7. **TP7** - PG\_OFFSET
8. **TP8** - GND
9. **TP9** - GND
10. **TP10** - MBRST0\*
11. **TP11** - MBRST1\*
12. **TP12** - MBRST2\*
13. **TP13** - MBRST3\*
14. **TP14** - MBRST4\*
15. **TP15** - MBRST5\*
16. **TP16** - MBRST6\*
17. **TP17** - MBRST7\*
18. **TP18** - MBRST8\*
19. **TP19** - MBRST9\*
20. **TP20** - MBRST10\*
21. **TP21** - MBRST11\*
22. **TP22** - MBRST12\*
23. **TP23** - MBRST13\*
24. **TP24** - MBRST15\*
25. **TP25** - MBRST14\*
26. **TP26** - N/A
27. **TP27** - N/A
28. **TP28** - N/A
29. **TP29** - N/A
30. **TP30** - GND
31. **TP31** - GND
32. **TP32** - DMD\_P1P8V

---

**NOTE:** (\*) - These signals are not internally connected in the DMD

---

### 3.2.2 Connectors

1. **J1** - Flex Cable Connector
2. **J2** - Flex Cable Connector
3. **J4** - I2C

### 3.3 DLPDLCR470TEVM Connections

depicts the switches and connectors with their respective locations.

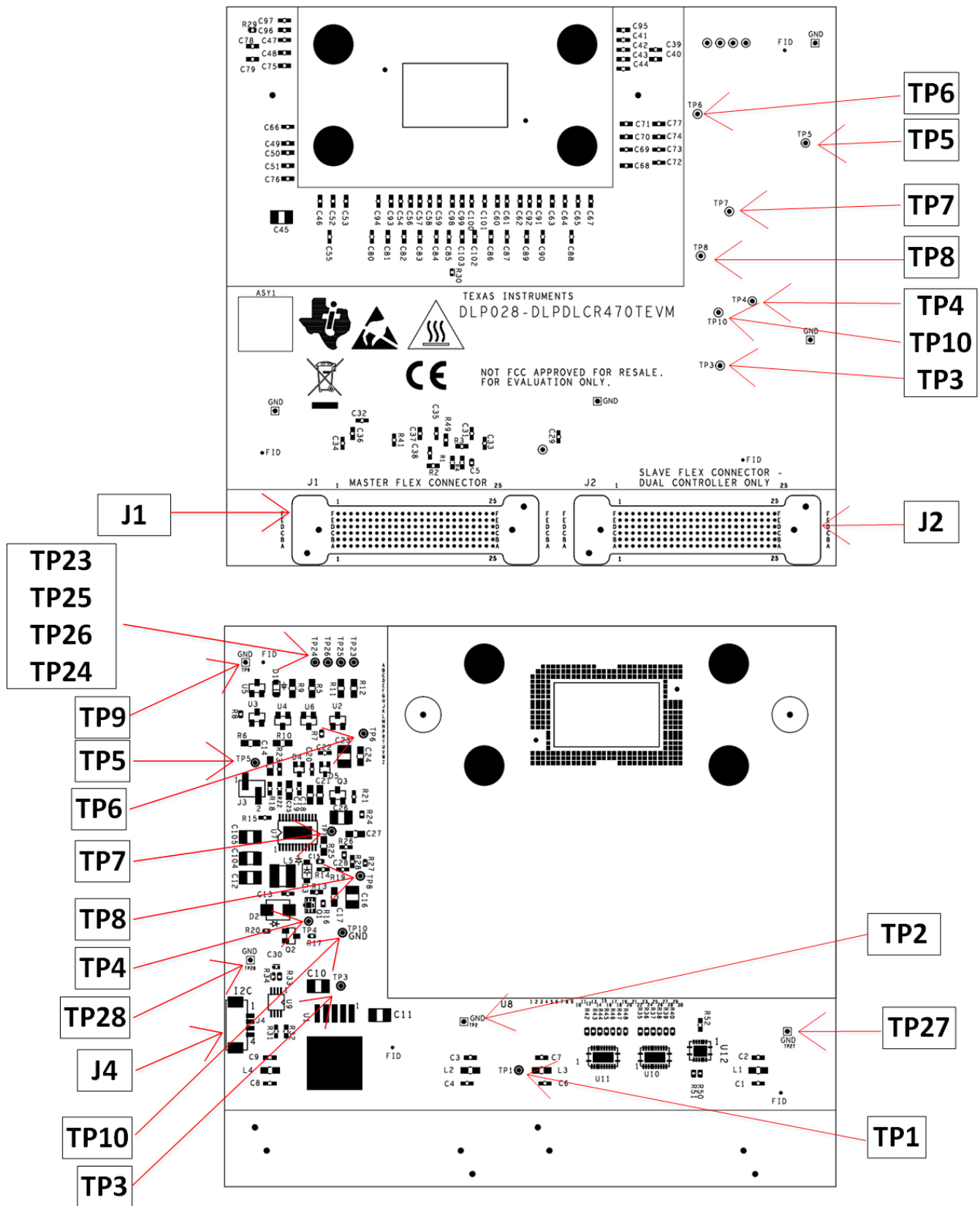

Figure 3-3. DLPDLCR470TEVM Test Points and Connectors

### 3.3.1 Test Points

1. **TP1** - DMD\_P3P3V
2. **TP2** - GND
3. **TP3** - DMD\_P1P8V
4. **TP4** - VOFFSET
5. **TP5** - EN\_OFFSET
6. **TP6** - VRESET
7. **TP7** - VBIAS
8. **TP8** - PG\_OFFSET
9. **TP9** - GND
10. **TP10** - GND
11. **TP23** - BIST\_A
12. **TP24**- BIST\_B
13. **TP25**- BIST\_C
14. **TP26**- BIST\_D
15. **TP27** - GND
16. **TP28** - GND

### 3.3.2 Connectors

1. **J1** - Flex Cable Connector
2. **J2** - Flex Cable Connector
3. **J4** - I2C

## Power Supply Requirements

---

---

### 4.1 External Power Supply Requirements

The DLPLCRDC4422EVM does not include a power supply. The external power supply requirements are:

- Nominal voltage: 12-V DC -5%/+10%
- Maximum Output Current: 7 A
- DC connector size:
  - Inner diameter: 2.5 mm
  - Outer diameter: 5.5 mm
  - Shaft: 9.5-mm female, center positive
- Efficiency level: V
- A recommended power supply is
- [Digi-Key part number 993-1009-ND](#), or equivalent

---

**NOTE:** External Power Supply Regulatory Compliance Certifications: Recommend selection and use of an external power supply, which meets TI's required minimum electrical ratings in addition to complying with applicable regional product regulatory and safety certification requirements such as (by example) UL, CSA, VDE, CCC, PSE, and so forth.

---

### 5.1 Caution Labels

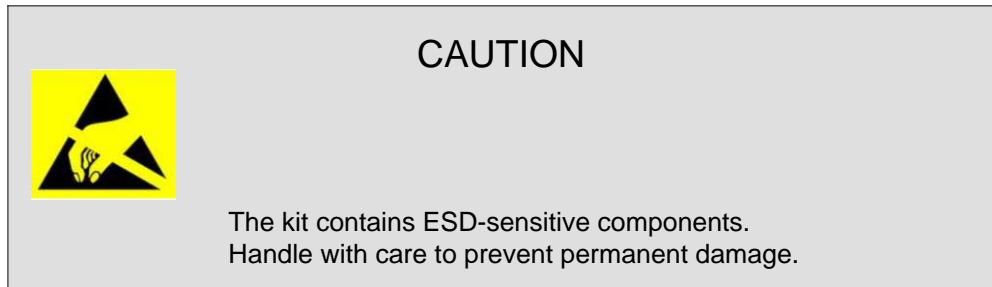

### 5.2 If You Need Assistance

Refer to the

[DLP E2E Community support forums](#).

## Revision History

NOTE: Page numbers for previous revisions may differ from page numbers in the current version.

<b>Changes from Original (March 2019) to A Revision</b>	<b>Page</b>
• Added DLPDLCR470TEVM to the User's Guide; a global change. ....	5
• Changed "Together" to "in pairs" in <a href="#">Section 1.2</a> .....	6
• Changed "The DLPLCRDC4422EVM can be programmed with the DLP660TE firmware which is available on the DLPC4422 product page. This firmware allows the DLPLCRDC4422EVM to drive the DLP660TE chip." to "The DLPLCRDC4422EVM can be programmed with either the DLP660TE or DLP470TE firmware which is available on the DLPC4422 product page. This firmware allows the DLPLCRDC4422EVM to drive either display chip." .....	6
• Removed text " Note that neither the cables nor the power supply are included with the module." from <a href="#">Section 3.2</a> . ....	27

## IMPORTANT NOTICE AND DISCLAIMER

TI PROVIDES TECHNICAL AND RELIABILITY DATA (INCLUDING DATASHEETS), DESIGN RESOURCES (INCLUDING REFERENCE DESIGNS), APPLICATION OR OTHER DESIGN ADVICE, WEB TOOLS, SAFETY INFORMATION, AND OTHER RESOURCES "AS IS" AND WITH ALL FAULTS, AND DISCLAIMS ALL WARRANTIES, EXPRESS AND IMPLIED, INCLUDING WITHOUT LIMITATION ANY IMPLIED WARRANTIES OF MERCHANTABILITY, FITNESS FOR A PARTICULAR PURPOSE OR NON-INFRINGEMENT OF THIRD PARTY INTELLECTUAL PROPERTY RIGHTS.

These resources are intended for skilled developers designing with TI products. You are solely responsible for (1) selecting the appropriate TI products for your application, (2) designing, validating and testing your application, and (3) ensuring your application meets applicable standards, and any other safety, security, or other requirements. These resources are subject to change without notice. TI grants you permission to use these resources only for development of an application that uses the TI products described in the resource. Other reproduction and display of these resources is prohibited. No license is granted to any other TI intellectual property right or to any third party intellectual property right. TI disclaims responsibility for, and you will fully indemnify TI and its representatives against, any claims, damages, costs, losses, and liabilities arising out of your use of these resources.

TI's products are provided subject to TI's Terms of Sale ([www.ti.com/legal/termsofsale.html](http://www.ti.com/legal/termsofsale.html)) or other applicable terms available either on [ti.com](http://ti.com) or provided in conjunction with such TI products. TI's provision of these resources does not expand or otherwise alter TI's applicable warranties or warranty disclaimers for TI products.

Mailing Address: Texas Instruments, Post Office Box 655303, Dallas, Texas 75265  
Copyright © 2019, Texas Instruments Incorporated