

Sonic Fast Recovery Diode

$$\begin{aligned} V_{RRM} &= 1600 \text{ V} \\ I_{FAV} &= 60 \text{ A} \\ t_{rr} &= 230 \text{ ns} \end{aligned}$$

High Performance Fast Recovery Diode
Low Loss and Soft Recovery
Single Diode

Part number

DH60-16A

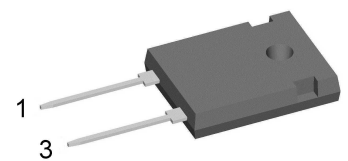

Backside: cathode

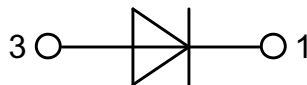

Features / Advantages:

- Planar passivated chips
- Very low leakage current
- Very short recovery time
- Improved thermal behaviour
- Very low I_{rm} -values
- Very soft recovery behaviour
- Avalanche voltage rated for reliable operation
- Soft reverse recovery for low EMI/RFI
- Low I_{rm} reduces:
 - Power dissipation within the diode
 - Turn-on loss in the commutating switch

Applications:

- Antiparallel diode for high frequency switching devices
- Antisaturation diode
- Snubber diode
- Free wheeling diode
- Rectifiers in switch mode power supplies (SMPS)
- Uninterruptible power supplies (UPS)

Package: TO-247

- Industry standard outline
- RoHS compliant
- Epoxy meets UL 94V-0

Terms Conditions of usage:

The data contained in this product data sheet is exclusively intended for technically trained staff. The user will have to evaluate the suitability of the product for the intended application and the completeness of the product data with respect to his application. The specifications of our components may not be considered as an assurance of component characteristics. The information in the valid application- and assembly notes must be considered. Should you require product information in excess of the data given in this product data sheet or which concerns the specific application of your product, please contact your local sales office.

Due to technical requirements our product may contain dangerous substances. For information on the types in question please contact your local sales office.

Should you intend to use the product in aviation, in health or life endangering or life support applications, please notify. For any such application we urgently recommend

- to perform joint risk and quality assessments;

- the conclusion of quality agreements;

- to establish joint measures of an ongoing product survey, and that we may make delivery dependent on the realization of any such measures.

Fast Diode				Ratings			
Symbol	Definition	Conditions	min.	typ.	max.	Unit	
V_{RSM}	max. non-repetitive reverse blocking voltage				1600	V	
V_{RRM}	max. repetitive reverse blocking voltage				1600	V	
I_R	reverse current, drain current	$V_R = 1600\text{ V}$			200	μA	
		$V_R = 1600\text{ V}$			2	mA	
V_F	forward voltage drop	$I_F = 60\text{ A}$			2.04	V	
		$I_F = 120\text{ A}$			2.57	V	
		$I_F = 60\text{ A}$			2.03	V	
		$I_F = 120\text{ A}$			2.73	V	
I_{FAV}	average forward current	$T_C = 100^\circ\text{C}$			60	A	
		rectangular $d = 0.5$					
V_{FO}	threshold voltage	} for power loss calculation only			1.28	V	
r_F	slope resistance				12	m Ω	
R_{thJC}	thermal resistance junction to case				0.3	K/W	
R_{thCH}	thermal resistance case to heatsink			0.25		K/W	
P_{tot}	total power dissipation				415	W	
I_{FSM}	max. forward surge current	$t = 10\text{ ms}; (50\text{ Hz}), \text{ sine}; V_R = 0\text{ V}$			700	A	
C_J	junction capacitance	$V_R = 1200\text{ V}$ $f = 1\text{ MHz}$			32	pF	
I_{RM}	max. reverse recovery current	} $I_F = 60\text{ A}; V_R = 1200\text{ V}$ $-di_F/dt = 800\text{ A}/\mu\text{s}$			60	A	
					70	A	
t_{rr}	reverse recovery time		$T_{VJ} = 25^\circ\text{C}$			230	ns
			$T_{VJ} = 100^\circ\text{C}$			350	ns

Package TO-247			Ratings			
Symbol	Definition	Conditions	min.	typ.	max.	Unit
I_{RMS}	RMS current	per terminal			70	A
T_{VJ}	virtual junction temperature		-55		150	°C
T_{op}	operation temperature		-55		125	°C
T_{stg}	storage temperature		-55		150	°C
Weight				6		g
M_D	mounting torque		0.8		1.2	Nm
F_C	mounting force with clip		20		120	N

Product Marking

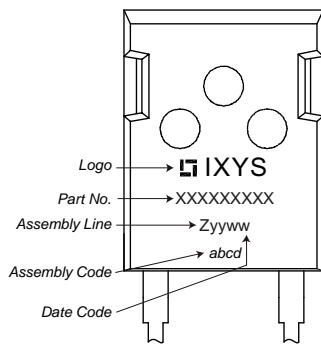

Ordering	Ordering Number	Marking on Product	Delivery Mode	Quantity	Code No.
Standard	DH60-16A	DH60-16A	Tube	30	496545

Similar Part	Package	Voltage class
DH60-14A	TO-247AD (2)	1400
DH60-18A	TO-247AD (2)	1800

Equivalent Circuits for Simulation

* on die level

$T_{VJ} = 150\text{ °C}$

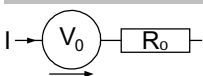

Fast Diode

$V_{0\ max}$	threshold voltage	1.28	V
$R_{0\ max}$	slope resistance *	9.5	mΩ

Outlines TO-247

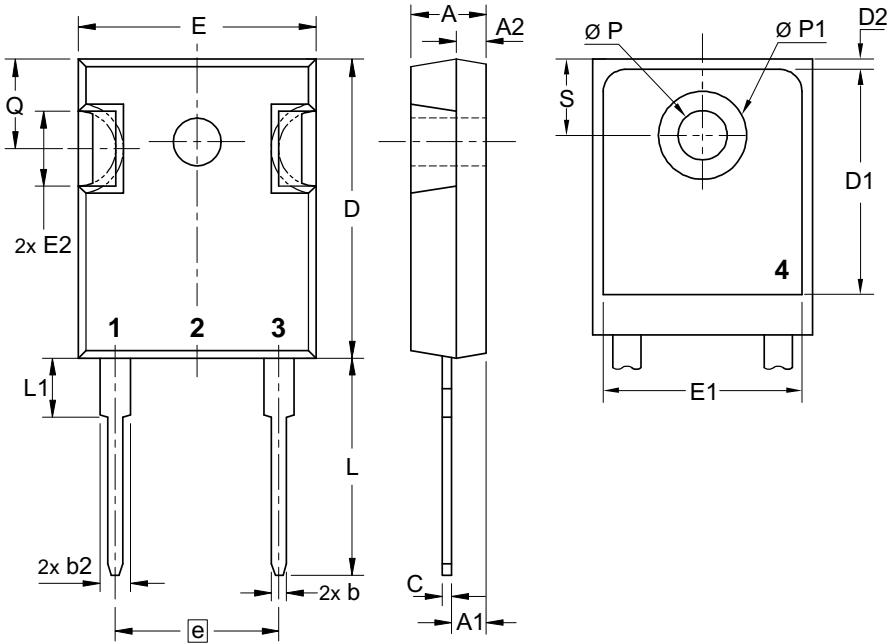

Sym.	Inches		Millimeter	
	min.	max.	min.	max.
A	0.185	0.209	4.70	5.30
A1	0.087	0.102	2.21	2.59
A2	0.059	0.098	1.50	2.49
D	0.819	0.845	20.79	21.45
E	0.610	0.640	15.48	16.24
E2	0.170	0.216	4.31	5.48
e	0.430 BSC		10.92 BSC	
L	0.780	0.800	19.80	20.30
L1	-	0.177	-	4.49
Ø P	0.140	0.144	3.55	3.65
Q	0.212	0.244	5.38	6.19
S	0.242 BSC		6.14 BSC	
b	0.039	0.055	0.99	1.40
b2	0.065	0.094	1.65	2.39
b4	0.102	0.135	2.59	3.43
c	0.015	0.035	0.38	0.89
D1	0.515	-	13.07	-
D2	0.020	0.053	0.51	1.35
E1	0.530	-	13.45	-
Ø P1	-	0.29	-	7.39

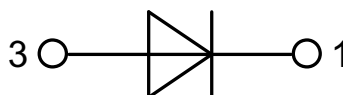

Fast Diode

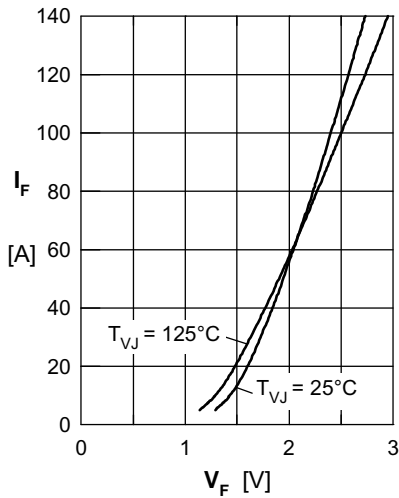

Fig. 1 Typ. forward current I_F versus V_F

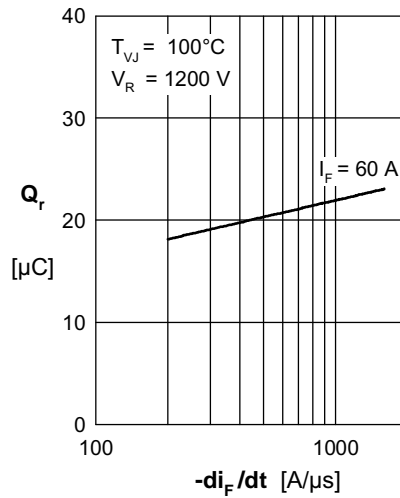

Fig. 2 Typ. reverse recovery charge Q_r versus $-di_F/dt$

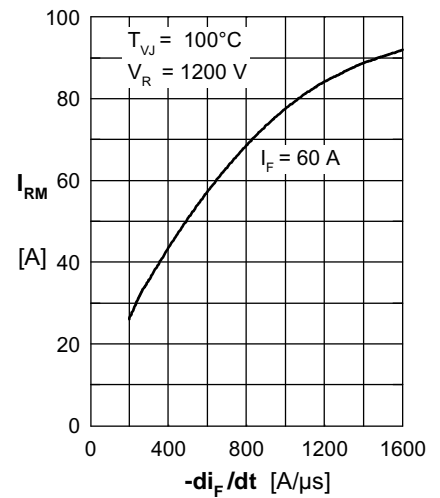

Fig. 3 Typ. peak reverse current I_{RM} versus $-di_F/dt$

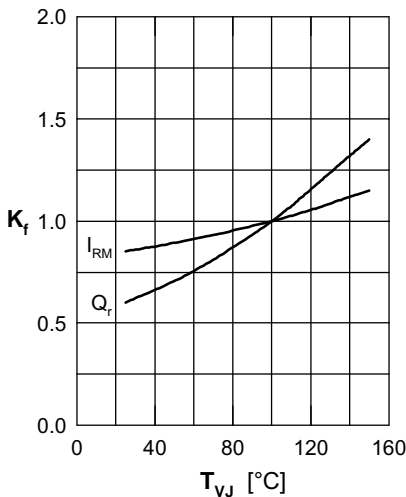

Fig. 4 Dynamic parameters Q_r , I_{RM} versus T_{VJ}

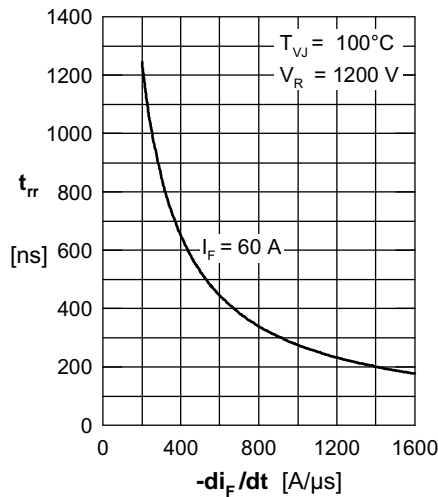

Fig. 5 Typ. recovery time t_{rr} versus $-di_F/dt$

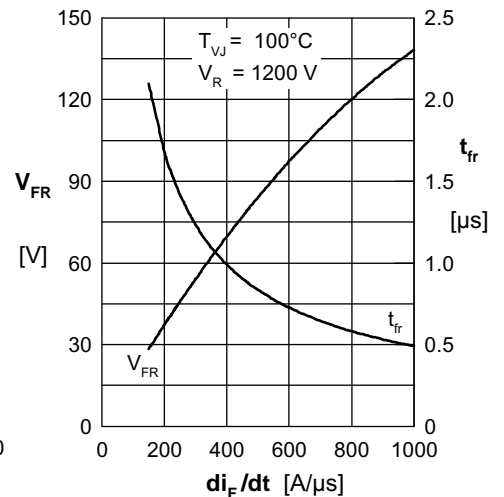

Fig. 6 Typ. peak forward voltage V_{FR} & typ. forward recovery time t_{fr} versus di_F/dt

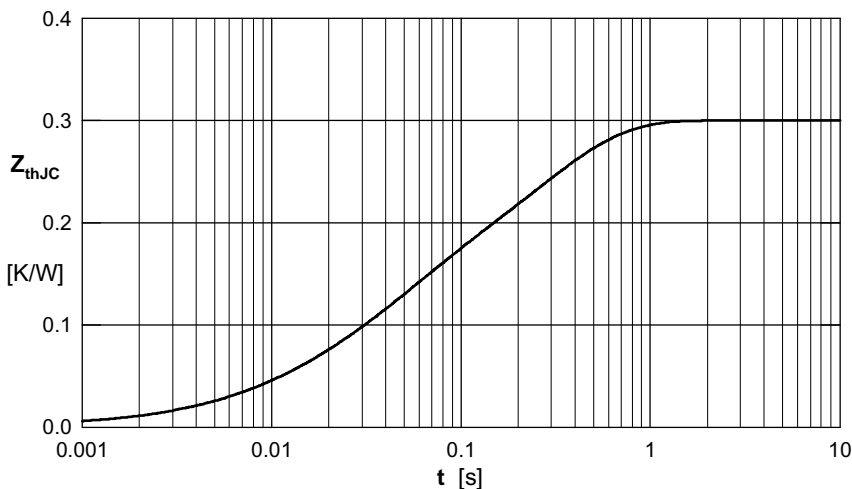

Fig. 7 Transient thermal resistance junction to case

i	R_i	q
1	0.021	0.0093
2	0.11	0.038
3	0.169	0.274