

FEATURES

- Low Frequency to 1.4GHz Bandwidth
- 100kHz to 1GHz Flat Gain from a Single Demo Circuit
- Low Frequency Cutoff Is User Defined
- 15.9dB Power Gain
- 52dBm OIP3 at 1MHz
- 47dBm OIP3 at 150MHz
- NF = 3.22dB at 150MHz
- 1nV/√Hz Total Input Noise Density at 150MHz
- S11 < -10dB Up to 1.2GHz
- S22 < -10dB Up to 1.0GHz
- >2V_{p,p} Linear Output Swing
- P1dB = 19.2dBm
- DC Power = 475mW
- 50Ω Single-Ended Operation
- Insensitive to V_{CC} Variation
- A-Grade 100% OIP3 Tested at 150MHz
- Input/Output Internally Matched to 50Ω
- Single 5V Supply
- Unconditionally Stable

APPLICATIONS

- Single-Ended IF Amplifier
- ADC Driver
- CATV
- Test Equipment

DESCRIPTION

The LTC[®]6433-15 is a gain-block amplifier with excellent linearity at frequencies below 100kHz to beyond 1000MHz and with low associated output noise.

The unique combination of high linearity, low noise and low power dissipation makes this an ideal candidate for many signal-chain applications. The LTC6433-15 is easy to use, requiring a minimum of external components. It is internally input/output matched to 50Ω and it draws only 95mA from a single 5V supply.

The LTC6433-15 operates over a wide bandwidth. A single demonstration circuit offers flat gain from 100kHz to 1GHz.

While this device is not capable of DC coupled operation, users can define the low frequency cut-off by appropriate choice of external components.

On-chip bias and temperature compensation maintain performance over environmental changes.

The LTC6433-15 uses a high performance SiGe BiCMOS process for excellent repeatability compared with similar GaAs amplifiers. All A-grade LTC6433-15 devices are tested and guaranteed for OIP3 at 150MHz. The LTC6433-15 is housed in a 4mm × 4mm 24-lead QFN package with an exposed pad for thermal management and low inductance.

LT, LTC, LTM, Linear Technology and the Linear logo are registered trademarks of Linear Technology Corporation. All other trademarks are the property of their respective owners.

TYPICAL APPLICATION

Single-Ended IF Amplifier

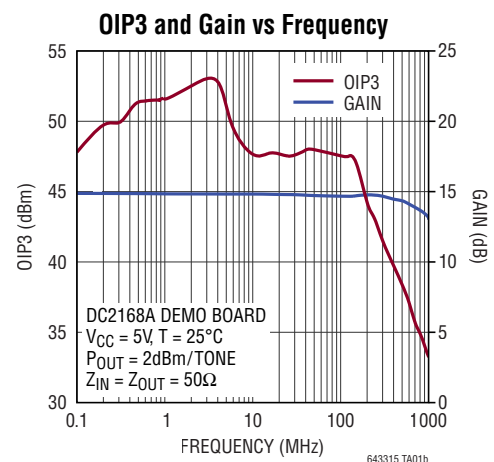
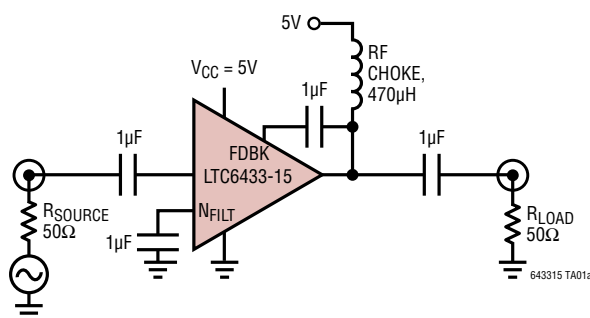

643315f

LTC6433-15

ABSOLUTE MAXIMUM RATINGS

(Note 1)

Total Supply Voltage (V_{CC} to GND)	5.5V
Amplifier Output Current (OUT)	115mA
RF Input Power, Continuous, 50 Ω (Note 2)	15dBm
RF Input Power, 100 μ s Pulse, 50 Ω (Note 2)	20dBm
Operating Case Temperature Range (T_{CASE})	-40°C to 85°C
Storage Temperature Range	-65°C to 150°C
Junction Temperature (T_J)	150°C

PIN CONFIGURATION

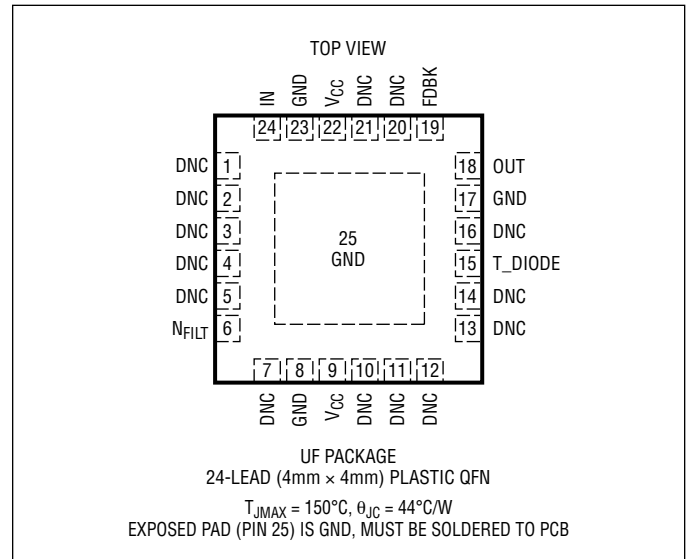

ORDER INFORMATION <http://www.linear.com/product/LTC6433-15#orderinfo>

LEAD FREE FINISH	TAPE AND REEL	PART MARKING*	PACKAGE DESCRIPTION	TEMPERATURE RANGE
LTC6433AIUF-15#PBF	LTC6433AIUF-15#TRPBF	43315	24-Lead (4mm x 4mm) Plastic QFN	-40°C to 85°C
LTC6433BIUF-15#PBF	LTC6433BIUF-15#TRPBF	43315	24-Lead (4mm x 4mm) Plastic QFN	-40°C to 85°C

Consult LTC Marketing for parts specified with wider operating temperature ranges. *The temperature grade is identified by a label on the shipping container.

For more information on lead free part marking, go to: <http://www.linear.com/leadfree/>

For more information on tape and reel specifications, go to: <http://www.linear.com/tapeandreel/>. Some packages are available in 500 unit reels through designated sales channels with #TRMPBF suffix.

DC ELECTRICAL CHARACTERISTICS

The ● denotes the specifications which apply over the full operating temperature range, otherwise specifications are at $T_A = 25^\circ\text{C}$, $V_{CC} = 5\text{V}$, $Z_{SOURCE} = Z_{LOAD} = 50\Omega$. Typical measured DC electrical performance using Test Circuit A.

SYMBOL	PARAMETER	CONDITIONS	MIN	TYP	MAX	UNITS
V_S	Operating Supply Range		4.75	5.0	5.25	V
$I_{S,TOT}$	Total Supply Current	All V_{CC} Pins Plus OUT	75 67	95	106 112	mA mA
$I_{S,OUT}$	Total Supply Current to OUT Pin	Current to OUT	62 55	82	92 95	mA mA
$I_{CC,OUT}$	Current to V_{CC} Pin	Either V_{CC} Pin May Be Used	12 12.5	13	16 17.5	mA mA
V_{DIODE}	Temperature Diode Voltage	T_{Diode} Current = 1mA		0.85		V
T_C	Diode Temperature Coefficient			1.4		mV/°C

643315f

AC ELECTRICAL CHARACTERISTICS

$T_A = 25^\circ\text{C}$ (Note 3), $V_{CC} = 5\text{V}$, $Z_{SOURCE} = Z_{LOAD} = 50\Omega$, unless otherwise noted. Measurements are performed using Test Circuit A, measuring from 50Ω SMA to 50Ω SMA without de-embedding (Note 4).

SYMBOL	PARAMETER	CONDITIONS	MIN	TYP	MAX	UNITS
Small Signal						
BW	-3dB Bandwidth	De-Embedded to Package (Low Frequency is User Defined)		2000		MHz
S11	Input Return Loss, 100kHz to 1700MHz	De-Embedded to Package		-10		dB
S21	Forward Power Gain, 100kHz to 300MHz	De-Embedded to Package		15.8		dB
S12	Reverse Isolation, 100kHz to 3000MHz	De-Embedded to Package		-19		dB
S22	Output Return Loss, 100kHz to 1000MHz	De-Embedded to Package		-10		dB
Frequency = 100kHz						
S21	Power Gain	De-Embedded to Package		16.0		dB
OIP3	Output Third-Order Intercept Point	$P_{OUT} = 2\text{dBm/Tone}$, $\Delta_f = 1\text{MHz}$	A-Grade B-Grade	47.8 46.0		dBm dBm
IM3	Third-Order Intermodulation	$P_{OUT} = 2\text{dBm/Tone}$, $\Delta_f = 1\text{MHz}$	A-Grade B-Grade	-91.6 -88.0		dBc dBc
HD2	Second Harmonic Distortion	$P_{OUT} = 6\text{dBm}$		-65.0		dBc
HD3	Third Harmonic Distortion	$P_{OUT} = 6\text{dBm}$		-70.0		dBc
P1dB	Output 1dB Compression Point			19.2		dBm
NF	Noise Figure	De-Embedded to Package		6.67		dB
Frequency = 1MHz						
S21	Power Gain	De-Embedded to Package		16.0		dB
OIP3	Output Third-Order Intercept Point	$P_{OUT} = 2\text{dBm/Tone}$, $\Delta_f = 1\text{MHz}$	A-Grade B-Grade	52.0 49.0		dBm dBm
IM3	Third-Order Intermodulation	$P_{OUT} = 2\text{dBm/Tone}$, $\Delta_f = 1\text{MHz}$	A-Grade B-Grade	-100 -94.0		dBc dBc
HD2	Second Harmonic Distortion	$P_{OUT} = 6\text{dBm}$		-73.0		dBc
HD3	Third Harmonic Distortion	$P_{OUT} = 6\text{dBm}$		-81.0		dBc
P1dB	Output 1dB Compression Point			19.1		dBm
NF	Noise Figure	De-Embedded to Package		3.93		dB
Frequency = 10MHz						
S21	Power Gain	De-Embedded to Package		15.9		dB
OIP3	Output Third-Order Intercept Point	$P_{OUT} = 2\text{dBm/Tone}$, $\Delta_f = 8\text{MHz}$	A-Grade B-Grade	47.6 45.5		dBm dBm
IM3	Third-Order Intermodulation	$P_{OUT} = 2\text{dBm/Tone}$, $\Delta_f = 8\text{MHz}$	A-Grade B-Grade	-91.2 -87.0		dBc dBc
HD2	Second Harmonic Distortion	$P_{OUT} = 6\text{dBm}$		-54.0		dBc
HD3	Third Harmonic Distortion	$P_{OUT} = 6\text{dBm}$		-77.0		dBc
P1dB	Output 1dB Compression Point			19.3		dBm
NF	Noise Figure	De-Embedded to Package		3.65		dB

AC ELECTRICAL CHARACTERISTICS

$T_A = 25^\circ\text{C}$ (Note 3), $V_{CC} = 5\text{V}$, $Z_{SOURCE} = Z_{LOAD} = 50\Omega$, unless otherwise noted. Measurements are performed using Test Circuit A, measuring from 50 Ω SMA to 50 Ω SMA without de-embedding (Note 4).

SYMBOL	PARAMETER	CONDITIONS	MIN	TYP	MAX	UNITS
Frequency = 50MHz						
S21	Power Gain	De-Embedded to Package		15.9		dB
OIP3	Output Third-Order Intercept Point	$P_{OUT} = 2\text{dBm/Tone}$, $\Delta_f = 1\text{MHz}$ A-Grade B-Grade		48.0 46.0		dBm dBm
IM3	Third-Order Intermodulation	$P_{OUT} = 2\text{dBm/Tone}$, $\Delta_f = 1\text{MHz}$ A-Grade B-Grade		-92.0 -88.0		dBc dBc
HD2	Second Harmonic Distortion	$P_{OUT} = 6\text{dBm}$		-56.0		dBc
HD3	Third Harmonic Distortion	$P_{OUT} = 6\text{dBm}$		-84.0		dBc
P1dB	Output 1dB Compression Point			19.3		dBm
NF	Noise Figure	De-Embedded to Package		2.92		dB
Frequency = 100MHz						
S21	Power Gain	De-Embedded to Package		15.9		dB
OIP3	Output Third-Order Intercept Point	$P_{OUT} = 2\text{dBm/Tone}$, $\Delta_f = 1\text{MHz}$ A-Grade B-Grade		47.5 45.5		dBm dBm
IM3	Third-Order Intermodulation	$P_{OUT} = 2\text{dBm/Tone}$, $\Delta_f = 1\text{MHz}$ A-Grade B-Grade		-91.0 -87.0		dBc dBc
HD2	Second Harmonic Distortion	$P_{OUT} = 6\text{dBm}$		-55.0		dBc
HD3	Third Harmonic Distortion	$P_{OUT} = 6\text{dBm}$		-80.0		dBc
P1dB	Output 1dB Compression Point			19.2		dBm
NF	Noise Figure	De-Embedded to Package		3.10		dB
Frequency = 150MHz						
S21	Power Gain	De-Embedded to Package	●	14.5 14.25	15.9 16.5 16.75	dB
OIP3	Output Third-Order Intercept Point	$P_{OUT} = 2\text{dBm/Tone}$, $\Delta_f = 1\text{MHz}$ A-Grade B-Grade		43.0 47.2 45.0		dBm dBm
IM3	Third-Order Intermodulation	$P_{OUT} = 2\text{dBm/Tone}$, $\Delta_f = 1\text{MHz}$ A-Grade B-Grade		-82.0 -90.4 -86.0		dBc dBc
HD2	Second Harmonic Distortion	$P_{OUT} = 6\text{dBm}$		-54.0		dBc
HD3	Third Harmonic Distortion	$P_{OUT} = 6\text{dBm}$		-78.0		dBc
P1dB	Output 1dB Compression Point			19.2		dBm
NF	Noise Figure	De-Embedded to Package		3.22		dB
e_n	Noise Density	Input Referred		1		nV/ $\sqrt{\text{Hz}}$
Frequency = 240MHz						
S21	Power Gain	De-Embedded to Package		15.9		dB
OIP3	Output Third-Order Intercept Point	$P_{OUT} = 2\text{dBm/Tone}$, $\Delta_f = 1\text{MHz}$ A-Grade B-Grade		43.1 42.0		dBm dBm
IM3	Third-Order Intermodulation	$P_{OUT} = 2\text{dBm/Tone}$, $\Delta_f = 1\text{MHz}$ A-Grade B-Grade		-82.2 -80.0		dBc dBc
HD2	Second Harmonic Distortion	$P_{OUT} = 6\text{dBm}$		-53.0		dBc
HD3	Third Harmonic Distortion	$P_{OUT} = 6\text{dBm}$		-73.0		dBc
P1dB	Output 1dB Compression Point			19.1		dBm
NF	Noise Figure	De-Embedded to Package		3.44		dB

AC ELECTRICAL CHARACTERISTICS

$T_A = 25^\circ\text{C}$ (Note 3), $V_{CC} = 5\text{V}$, $Z_{SOURCE} = Z_{LOAD} = 50\Omega$, unless otherwise noted. Measurements are performed using Test Circuit A, measuring from 50Ω SMA to 50Ω SMA without de-embedding (Note 4).

SYMBOL	PARAMETER	CONDITIONS	MIN	TYP	MAX	UNITS
Frequency = 300MHz						
S21	Power Gain	De-Embedded to Package		15.8		dB
OIP3	Output Third-Order Intercept Point	$P_{OUT} = 2\text{dBm/Tone}$, $\Delta_f = 1\text{MHz}$ A-Grade B-Grade		41.5 40.0		dBm dBm
IM3	Third-Order Intermodulation	$P_{OUT} = 2\text{dBm/Tone}$, $\Delta_f = 1\text{MHz}$ A-Grade B-Grade		-79.0 -76.0		dBc dBc
HD2	Second Harmonic Distortion	$P_{OUT} = 6\text{dBm}$		-51.9		dBc
HD3	Third Harmonic Distortion	$P_{OUT} = 6\text{dBm}$		-72.0		dBc
P1dB	Output 1dB Compression Point			19.0		dBm
NF	Noise Figure	De-Embedded to Package		3.61		dB
Frequency = 500MHz						
S21	Power Gain	De-Embedded to Package		15.5		dB
OIP3	Output Third-Order Intercept Point	$P_{OUT} = 2\text{dBm/Tone}$, $\Delta_f = 1\text{MHz}$ A-Grade B-Grade		38.4 37.0		dBm dBm
IM3	Third-Order Intermodulation	$P_{OUT} = 2\text{dBm/Tone}$, $\Delta_f = 1\text{MHz}$ A-Grade B-Grade		-72.8 -70.0		dBc dBc
HD2	Second Harmonic Distortion	$P_{OUT} = 6\text{dBm}$		-51.0		dBc
HD3	Third Harmonic Distortion	$P_{OUT} = 6\text{dBm}$		-70.0		dBc
P1dB	Output 1dB Compression Point			18.9		dBm
NF	Noise Figure	De-Embedded to Package		3.93		dB
Frequency = 800MHz						
S21	Power Gain	De-Embedded to Package		15.0		dB
OIP3	Output Third-Order Intercept Point	$P_{OUT} = 2\text{dBm/Tone}$, $\Delta_f = 1\text{MHz}$ A-Grade B-Grade		34.9 33.5		dBm dBm
IM3	Third-Order Intermodulation	$P_{OUT} = 2\text{dBm/Tone}$, $\Delta_f = 1\text{MHz}$ A-Grade B-Grade		-65.8 -63.0		dBc dBc
HD2	Second Harmonic Distortion	$P_{OUT} = 6\text{dBm}$		-47.0		dBc
HD3	Third Harmonic Distortion	$P_{OUT} = 6\text{dBm}$		-59.5		dBc
P1dB	Output 1dB Compression Point			18.0		dBm
NF	Noise Figure	De-Embedded to Package		4.40		dB
Frequency = 1000MHz						
S21	Power Gain	De-Embedded to Package		14.5		dB
OIP3	Output Third-Order Intercept Point	$P_{OUT} = 2\text{dBm/Tone}$, $\Delta_f = 1\text{MHz}$ A-Grade B-Grade		33.3 32.0		dBm dBm
IM3	Third-Order Intermodulation	$P_{OUT} = 2\text{dBm/Tone}$, $\Delta_f = 1\text{MHz}$ A-Grade B-Grade		-62.6 -60.0		dBc dBc
HD2	Second Harmonic Distortion	$P_{OUT} = 6\text{dBm}$		-45.0		dBc
HD3	Third Harmonic Distortion	$P_{OUT} = 6\text{dBm}$		-57.0		dBc
P1dB	Output 1dB Compression Point			17.3		dBm
NF	Noise Figure	De-Embedded to Package		4.83		dB

Note 1: Stresses beyond those listed under Absolute Maximum Ratings may cause permanent damage to the device. Exposure to any Absolute Maximum Rating condition for extended periods may affect device reliability and lifetime.

Note 2: Guaranteed by design and characterization. This parameter is not tested.

Note 3: The LTC6433-15 is guaranteed functional over the case operating temperature range of -40°C to 85°C .

Note 4: Small-signal parameters S and noise are de-embedded to the package pins, while large-signal parameters are measured directly from the circuit.

643315f

TYPICAL PERFORMANCE CHARACTERISTICS $T_A = 25^\circ\text{C}$, $V_{CC} = 5\text{V}$, $Z_{SOURCE} = Z_{LOAD} = 50\Omega$, unless otherwise noted. S parameter measurements are performed using $1\mu\text{F}$ feedback capacitor.

S Parameters vs Frequency

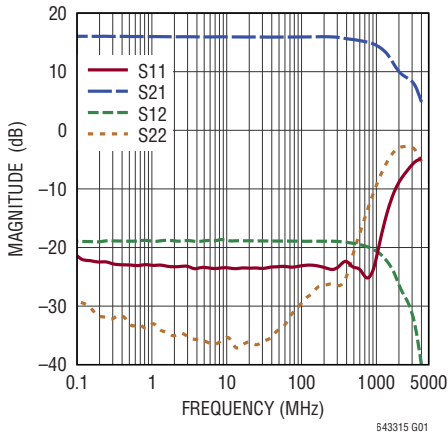

K Factor vs Frequency Over Temperature

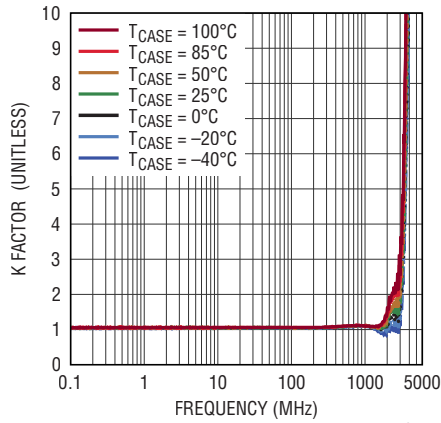

Noise Figure vs Frequency Over Temperature

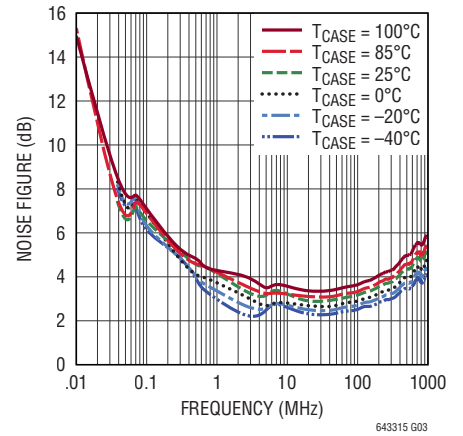

S11 vs Frequency Over Temperature

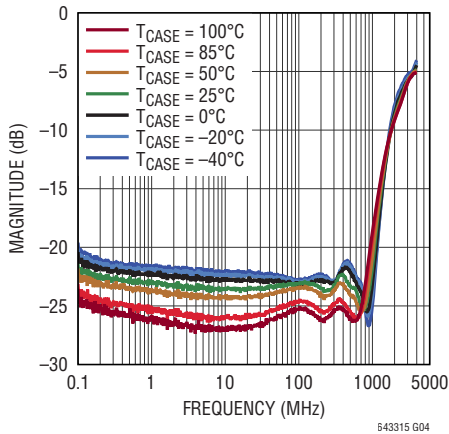

S21 vs Frequency Over Temperature

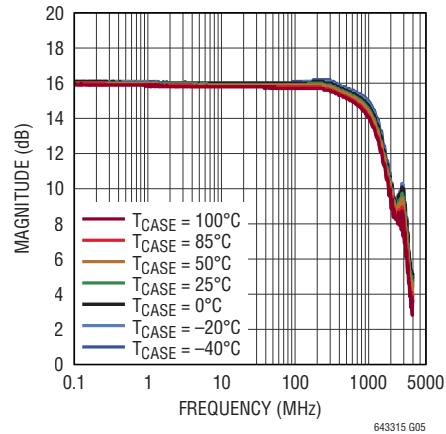

S12 vs Frequency Over Temperature

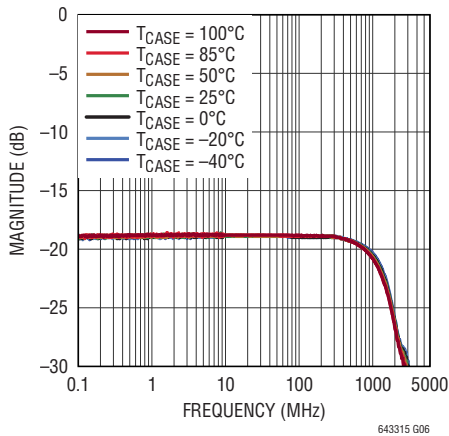

S22 vs Frequency Over Temperature

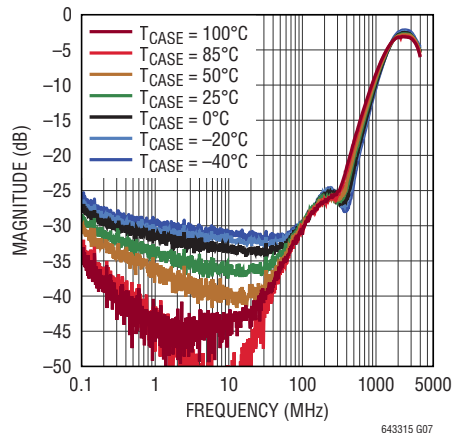

TYPICAL PERFORMANCE CHARACTERISTICS A-Grade

$T_A = 25^\circ\text{C}$, $V_{CC} = 5\text{V}$, $Z_{SOURCE} = Z_{LOAD} = 50\Omega$, unless otherwise noted. Measurements are performed using Test Circuit A, measuring from 50Ω SMA to 50Ω SMA without de-embedding (Note 4).

OIP3 vs Frequency

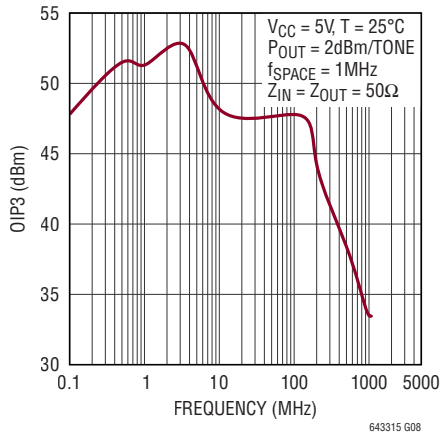

OIP3 vs RF Output Power Over Frequency

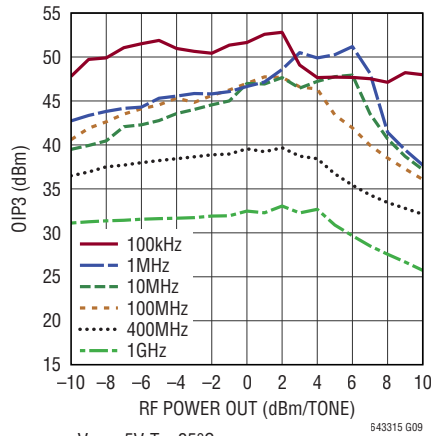

OIP3 vs Voltage Over Frequency

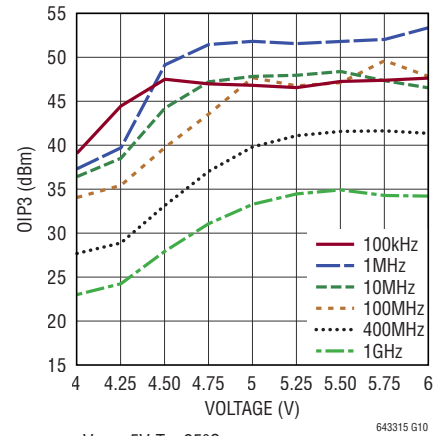

OIP3 vs Tone Spacing Over Frequency

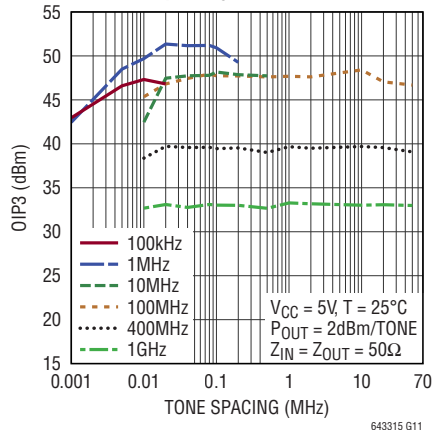

OIP3 vs Frequency Over Case Temperature

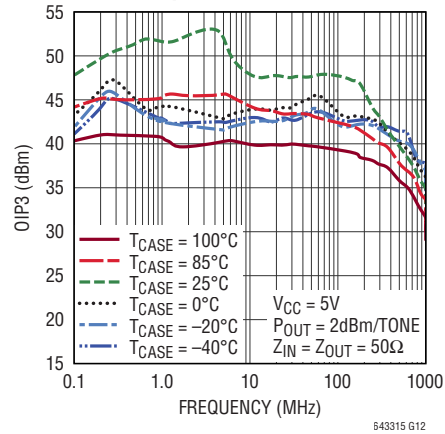

TYPICAL PERFORMANCE CHARACTERISTICS $T_A = 25^\circ\text{C}$, $V_{CC} = 5\text{V}$, $Z_{SOURCE} = Z_{LOAD} = 50\Omega$, unless otherwise noted. Measurements are performed using Test Circuit A, measuring from 50Ω SMA to 50Ω SMA without de-embedding (Note 4).

2nd Harmonic vs Frequency Over RF Power Out

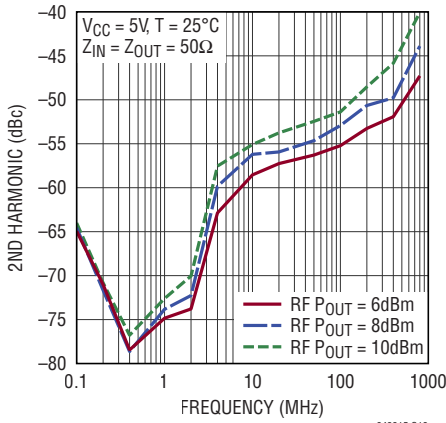

643315 G13

3rd Harmonic vs Frequency Over RF Power Out

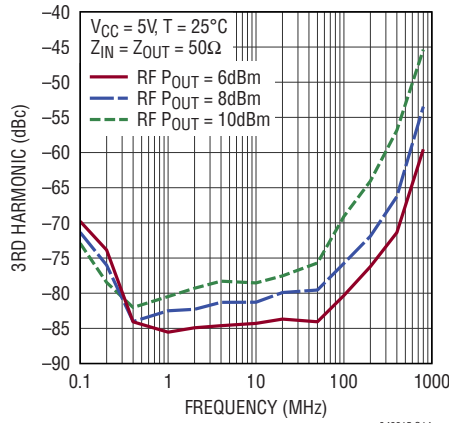

643315 G14

4th Harmonic vs Frequency Over RF Power Out

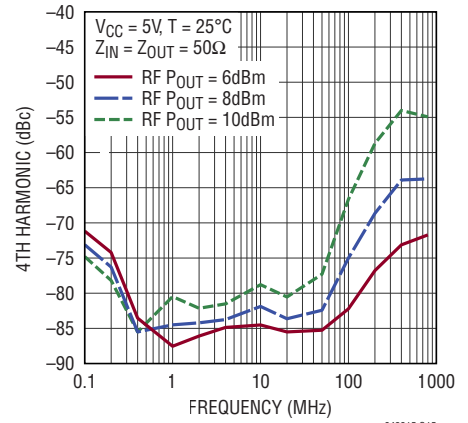

643315 G15

I_TOTAL vs V_CC

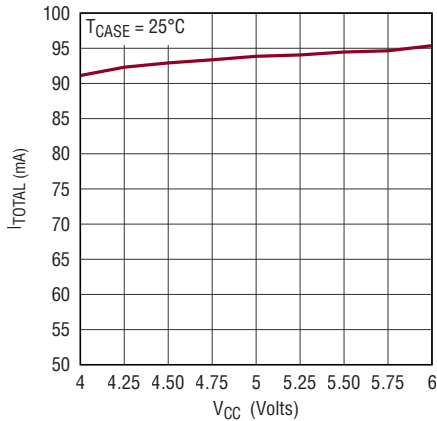

643315 G16

I_TOTAL vs T_CASE

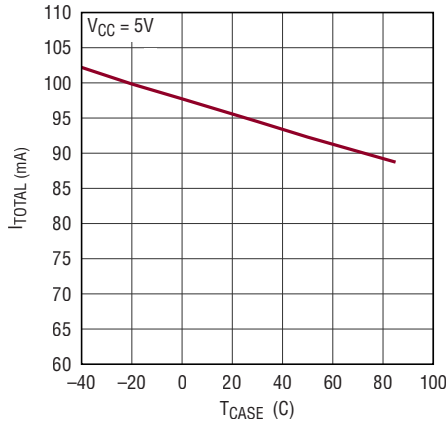

643315 G17

I_TOTAL vs Input Power

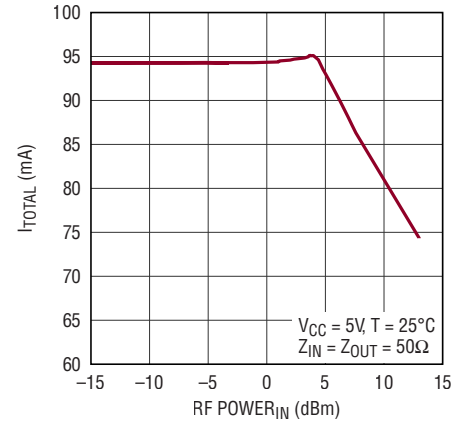

643315 G18

RF Power Out vs RF Power In Over Frequency

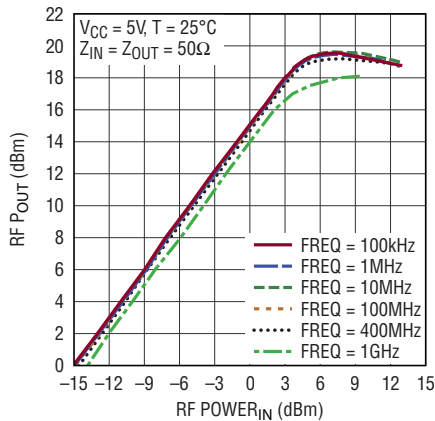

643315 G19

Gain vs RF Power In Over Frequency

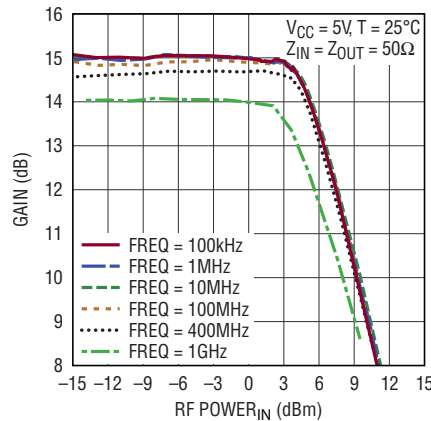

643315 G20

P1dB vs Frequency

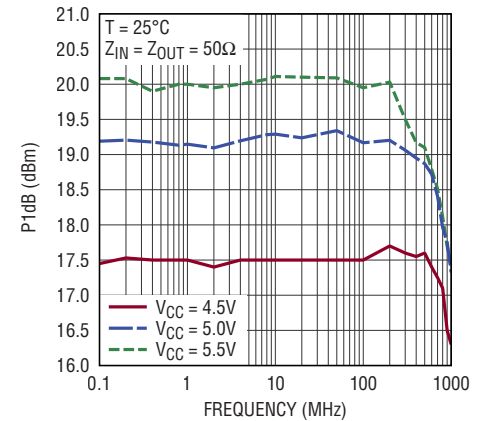

643315 G21

643315f

PIN FUNCTIONS

GND (Pins 8, 17, 23, Exposed Pad Pin 25): Ground. For best RF performance, all ground pins should be connected to the printed circuit board ground plane. The exposed pad should have multiple via holes to an underlying ground plane for low inductance and good thermal dissipation.

IN (Pin 24): Signal Input Pin. This pin has an internally generated 2V DC bias. A DC blocking capacitor is required. See the Applications Information section for specific recommendations.

V_{CC} (Pins 9, 22): Positive Power Supply. Either V_{CC} pin should be connected to the 5V supply. Bypass the V_{CC} pin with 1000pF and 0.1μF capacitors. The 1000pF capacitor should be physically close to the package. Pins 9 and 22 are internally connected within the package

N_{FILT} (Pins 6): Noise Filter Capacitor. A capacitor to GND is required to reduce low frequency noise.

FDBK (Pin 19): A feedback capacitor is required between OUT (Pin 18) and the FDBK pin to ensure good matching and gain flatness at low frequencies.

OUT (Pin 18): Amplifier Output Pin. A choke inductor is necessary to provide power from the 5V supply and to provide RF isolation. For best performance select a choke with low DC loss and high self-resonant frequency (SRF). A DC blocking capacitor is also required. See the Applications Information section for specific recommendations.

DNC (Pins 1 to 5, 7, 10 to 14, 16, 20, 21): Do Not Connect. Do not connect these pins; allow them to **float**. **Failure to float these pins may impair operation of the LTC6433-15.**

T_DIODE (Pin 15): Optional Diode. The T_DIODE can be forward-biased to ground with 1mA of current. The measured voltage will be an indicator of chip temperature.

BLOCK DIAGRAM

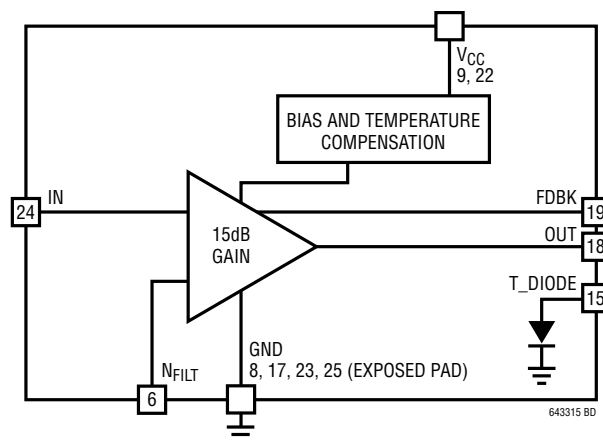

TEST CIRCUIT A

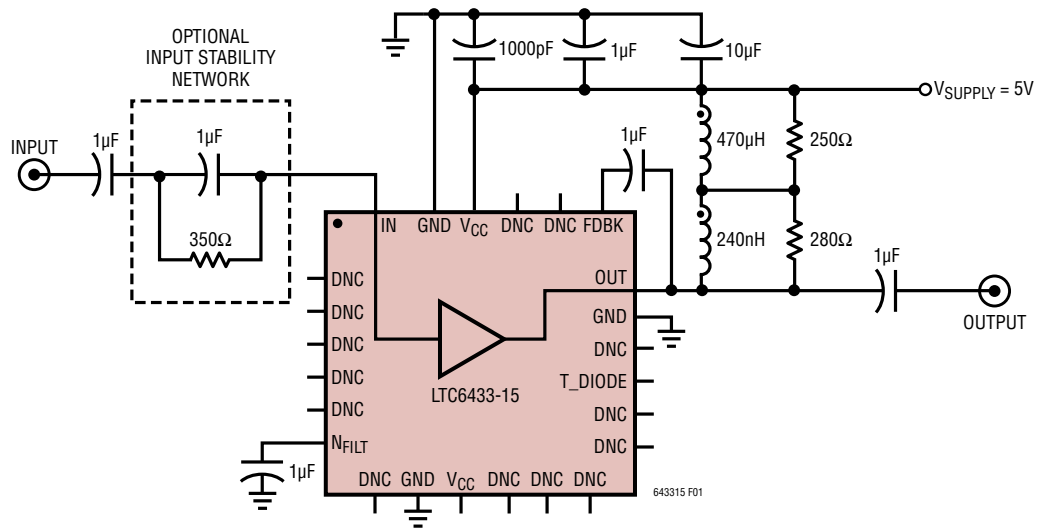

Figure 1. Test Circuit A Evaluation Circuit

OPERATION

The LTC6433-15 is a highly linear, fixed-gain amplifier that is configured to operate single ended. Its core signal path consists of a single amplifier stage minimizing stability issues. The input is a Darlington pair for high input impedance and high current gain. Additional circuit enhancements increase the output impedance and minimize the effects of internal Miller capacitance.

The LTC6433-15 starts with a classic RF gain-block topology but adds additional enhancements to achieve dramatically improved linearity. Shunt and series feedback are added to lower the input/output impedance and match them simultaneously to the 50Ω source and load. Meanwhile, an internal bias controller optimizes the internal operating point for peak linearity over environmental changes. This circuit architecture provides low noise, excellent RF power handling capability and wide bandwidth—characteristics that are desirable for IF signal chain applications.

APPLICATIONS INFORMATION

The LTC6433-15 is a highly linear fixed-gain amplifier designed for ease of use. Implementing an RF gain stage is often a multistep project. Typically an RF designer must choose a bias point and design a bias network. Next the designer needs to address impedance matching with input and output matching networks and, finally, add stability networks to ensure stable operation in and out of band. These tasks are handled internally within the LTC6433-15.

The LTC6433-15 has an internal self-biasing network which compensates for temperature variation and keeps the device biased for optimal linearity. Therefore, input and output DC blocking capacitors are required.

Both the input and output are internally impedance matched to 50Ω. An RF choke is required at the output to deliver DC current to the device. The RF choke acts as a high impedance (isolation) to the DC supply which is at RF ground. Thus, the internal LTC6433-15 impedance matching is unaffected by the biasing network. The open collector output topology can deliver much more power than an amplifier whose collector is biased through a resistor or active load.

Choosing the Right RF Choke

Not all choke inductors are created equal. Proper selection of a choke is critical to achieve high linearity and wide bandwidth. At frequencies below 100MHz, a large valued choke is required. It is always important to select an inductor with low R_{LOSS} , as this will drop the available voltage to the device. Also look for an inductor with high self-resonant frequency (SRF) as this will limit the upper frequency where the choke is useful. Above the SRF, its parasitic capacitance dominates and the choke impedance will drop. For these reasons, wire wound inductors are preferred, and multilayer ceramic chip inductors should be avoided for an RF choke. Choke inductors with magnetic cores should be used with caution as they can contribute distortion products themselves. We have successfully used power inductors as chokes but their evaluation at RF frequencies is normally left to the end user. Please see Table 1 for suggested RF chokes. Since the LTC6433-15 is capable of such wideband operation, a single choke value will not result in optimized performance across its full frequency band.

Table 1 lists target frequency bands and suggested corresponding inductor values.

Table 1. Target Frequency Bands and Suggested Inductor Values

FREQUENCY BAND	INDUCTOR VALUE	MODEL NUMBER	MANUFACTURER
100kHz to 500kHz	470μH	LPS5030	Coilcraft www.coilcraft.com
500kHz to 1MHz	220μH	LPS5030	
1MHz to 10MHz	120μH	LPS5030	
10MHz to 20MHz	12μH	LPS5030	
20MHz to 100MHz	1500nH	0805LS	
100MHz to 500MHz	560nH	0603LS	
500MHz to 1000MHz	100nH	0603LS	
1000MHz to 2000MHz	51nH	0603LS	

DC Blocking Capacitor

The role of a DC blocking capacitor is straightforward: block the path of DC current and allow a low series impedance path for the AC signal. Lower frequencies require a higher value of DC blocking capacitance. Generally, 1μF will suffice for operation down to 100kHz. Care must be taken when using high capacitance density materials. These high capacitance materials often have high voltage coefficients. At low frequencies this voltage dependence creates distortion products. Film caps and NPO caps get physically large and expensive at large capacitance values. High quality capacitors like the X8R series offer high capacitance density and good voltage coefficients. They are recommended for best linearity below 1 MHz.

RF Bypass Capacitor

RF bypass capacitors act to shunt AC signals to ground with a low impedance path. It is best to place them as close as possible to the DC power supply pins of the device. Any extra distance translates into additional series inductance which lowers the self-resonant frequency and useful bandwidth of the bypass capacitor. The suggested bypass capacitor network consists of multiple capacitors: a low value 1000pF capacitor to handle high frequencies in parallel with larger 0.1μF and 1μF capacitors to handle lower frequencies. Use ceramic capacitors of an appropriate physical size for each capacitance value (e.g., 0402 for the 1000pF, 0805 for the 0.1μF) to minimize the equivalent series resistance (ESR) of the capacitor.

APPLICATIONS INFORMATION

Low Frequency Stability

Most RF gain blocks suffer from low frequency instability. To avoid any stability issues, the LTC6433-15 has a feedback network that lowers the gain and matches the input and output impedances. This feedback network contains a series capacitor, so if at some low frequency the feedback fails, the gain increases and gross impedance mismatches occur—indeed a recipe for instability. Luckily, this situation is easily resolved with a parallel capacitor and resistor network on the input, as seen in Figure 1. This network provides resistive loss at low frequencies and is bypassed by the parallel capacitor within the desired band of operation. However, if the LTC6433-15 is preceded by a low frequency termination, such as a choke, the input stability network is NOT required.

Test Circuit

The test circuit shown in Figure 2 is designed to allow evaluation of the LTC6433-15 with standard single-ended 50Ω test equipment. The circuit requires a minimum of external components. Since the LTC6433-15 is a wideband part, the evaluation test circuit is optimized for wideband operation. Obviously, for narrowband applications, the circuit can be further optimized. As mentioned earlier, input and output DC blocking capacitors are required as this device is internally biased for optimal operation. A frequency appropriate choke and decoupling capacitors are required to provide DC bias to the RF out node. A 5V supply should also be applied to either of the V_{CC} pins on the device. A suggested parallel $1\mu\text{F}$, 350Ω network has been added to the input to ensure low frequency stability. The $1\mu\text{F}$ capacitance can be increased to improve low frequency performance. However, the designer needs to be sure that the impedance presented at low frequency will not create instability.

A $1\mu\text{F}$ noise filter capacitor is required to reduce low frequency noise.

Please note that a number of DNC pins are connected on the demo board. These connections are not necessary for normal circuit operation.

Exposed Pad and Ground Plane Considerations

As with any RF device, minimizing ground inductance is critical. Care should be taken with board layouts using these exposed pad packages. The maximum allowable number of minimum diameter via holes should be placed underneath the exposed pad and connect to as many ground plane layers as possible. This will provide good RF ground and low thermal impedance. Maximizing the copper ground plane will also improve heat spreading and lower inductance. It is a good idea to cover the via holes with a solder mask on the backside of the PCB to prevent the solder from wicking away from the critical PCB to the exposed pad interface.

Wideband Output Network

The DC2168A demonstration circuit has flat gain, excellent linearity and low noise from 100kHz to 1GHz. A key to this wide bandwidth performance is the output network. A single RF choke is replaced with a network that gives good RF isolation from 100kHz to 1GHz. In this case, we use a 240nH (0603) inductor in series with a 470 μH power inductor. The 240nH inductor provides isolation at high frequencies, while the 470 μH inductor provides RF isolation at low frequencies. Resistors are shunted across each inductor to flatten the loss over the desired 100kHz to 1GHz band. Our resulting output network has minimal R_{Loss} which allows operation with a single 5V supply.

APPLICATIONS INFORMATION

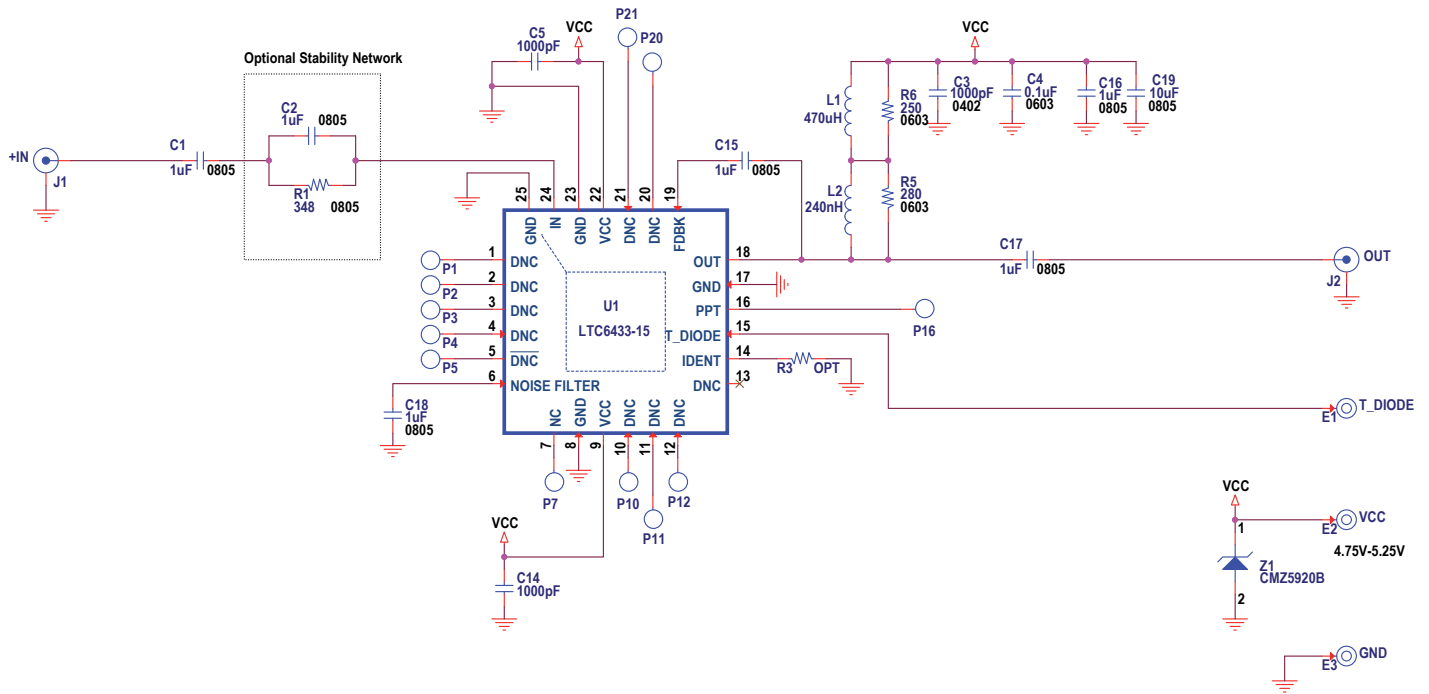

Figure 2. DC2168A Demo Board Schematic

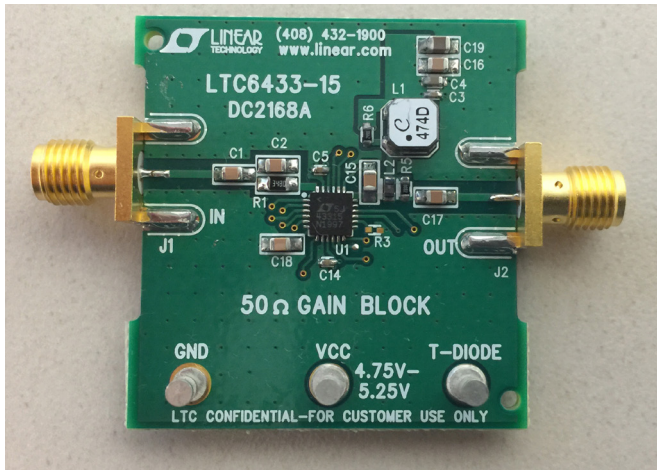

Figure 3. LTC6433-15 DC2168A Demo Board

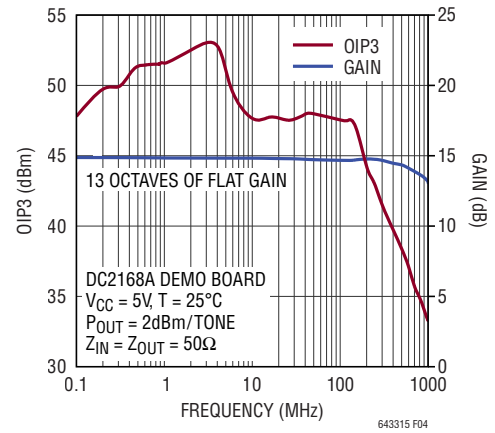

Figure 4. DC2168A Gain and OIP3 vs Frequency

S PARAMETERS 5V, 95mA, Z = 50Ω, T = 25°C, De-Embedded to Package Pins with 1μF Capacitors for FDBK

FREQUENCY (MHz)	S11 (Mag)	S11 (Ph)	S21 (Mag)	S21 (Ph)	S12 (Mag)	S12 (Ph)	S22 (Mag)	S22 (Ph)	GTU (Max)	Stability (K)
0.10	-21.17	-154.55	16.03	-178.41	-18.94	2.35	-29.13	144.63	16.07	1.05
0.13	-21.99	-161.40	16.04	-178.87	-19.00	1.42	-29.78	144.70	16.07	1.05
0.17	-22.17	-164.29	16.04	-179.08	-18.96	1.50	-29.93	150.01	16.07	1.05
0.22	-22.53	-168.19	16.04	-179.35	-18.97	1.53	-31.07	150.94	16.07	1.05
0.28	-22.44	-170.32	16.03	-179.66	-19.00	0.55	-31.75	151.77	16.06	1.05
0.36	-22.76	-174.13	16.02	-179.71	-18.92	0.74	-31.05	156.67	16.05	1.05
0.46	-22.71	-175.92	16.01	-179.92	-18.88	0.95	-32.09	158.81	16.04	1.05
0.60	-22.83	-176.07	16.00	-179.94	-18.87	0.19	-32.59	150.96	16.03	1.05
0.77	-22.90	-177.62	16.00	-179.89	-18.88	0.35	-32.60	165.65	16.03	1.05
0.99	-22.85	-179.20	15.98	-179.83	-18.96	0.45	-33.27	173.04	16.01	1.05
1.28	-22.81	59.69	15.99	-179.84	-18.90	-0.15	-33.35	165.78	16.01	1.05
1.66	-22.98	179.51	15.98	-179.62	-18.84	0.06	-33.19	163.84	16.00	1.05
2.14	-23.04	179.30	15.96	-179.69	-18.90	0.10	-34.38	165.49	15.99	1.05
2.76	-23.14	59.39	15.96	-179.56	-18.93	0.17	-34.22	166.41	15.98	1.05
3.53	-23.13	179.63	15.96	-179.44	-18.86	0.17	-34.35	171.91	15.98	1.05
4.56	-23.23	177.95	15.95	-179.46	-18.89	-0.58	-35.02	-59.59	15.97	1.05
5.91	-23.22	179.18	15.95	-179.26	-18.89	0.05	-36.06	59.25	15.97	1.05
7.64	-23.39	59.83	15.94	-179.16	-18.84	-0.59	-34.48	178.68	15.96	1.05
9.82	-23.30	179.10	15.93	-178.95	-18.88	-0.77	-35.63	-176.60	15.95	1.05
12.6	-23.37	-59.79	15.93	-178.71	-18.86	-1.01	-35.95	-174.44	15.95	1.05
16.3	-23.33	-179.27	15.92	-178.34	-18.87	-1.39	-35.75	-169.41	15.94	1.05
21.1	-23.36	-59.87	15.92	-177.89	-18.87	-1.77	-35.56	-166.88	15.94	1.05
27.2	-23.31	-178.86	15.91	-177.37	-18.86	-2.25	-36.36	-156.65	15.93	1.05
35.0	-23.36	-178.71	15.91	-176.71	-18.88	-2.96	-35.39	-150.36	15.93	1.05
44.7	-23.37	60.22	15.91	-175.81	-18.89	-3.73	-34.47	-147.63	15.93	1.05
58.1	-23.14	-178.81	15.91	-174.63	-18.91	-4.77	-33.34	-137.94	15.93	1.05
75.3	-23.16	60.12	15.92	-173.12	-18.92	-6.20	-31.32	-132.08	15.94	1.05
97.1	-23.15	58.97	15.93	-171.06	-18.93	-7.79	-29.78	-129.06	15.96	1.05
124.7	-23.06	176.54	15.94	-168.50	-18.93	-10.00	-28.36	-131.68	15.97	1.05
159.8	-23.05	175.44	15.96	-165.17	-18.93	-12.70	-27.35	-136.57	15.99	1.05
207.5	-23.11	174.45	15.97	-160.31	-18.92	-16.52	-26.45	-138.23	16.00	1.05
268.5	-23.27	173.39	15.91	-154.08	-18.95	-21.56	-26.24	-140.47	15.94	1.05
346.3	-22.28	171.00	15.76	-146.33	-19.01	-28.30	-26.83	-130.53	15.79	1.06
443.5	-22.24	167.12	15.56	-137.71	-19.18	-36.31	-24.05	-105.26	15.60	1.08
570.8	-23.19	160.37	15.35	-126.33	-19.44	-46.52	-19.01	-99.82	15.42	1.09
740.7	-24.51	163.54	15.09	-111.18	-19.83	-59.90	-14.36	-108.76	15.26	1.11
958.6	-22.68	-171.11	14.64	-91.27	-20.47	-77.09	-10.35	-124.40	15.09	1.12
1232.8	-17.01	-172.86	13.82	-65.84	-21.53	-98.71	-6.96	-146.60	14.88	1.09
1579.5	-12.08	158.84	12.10	-37.27	-23.30	-124.44	-4.40	-175.70	14.34	1.07
2000.1	-9.02	119.72	9.99	-6.13	-26.19	-151.27	-3.05	150.16	13.55	1.25

PACKAGE DESCRIPTION

Please refer to <http://www.linear.com/product/LTC6433-15#packaging> for the most recent package drawings.

UF Package
24-Lead Plastic QFN (4mm × 4mm)
 (Reference LTC DWG # 05-08-1697 Rev B)

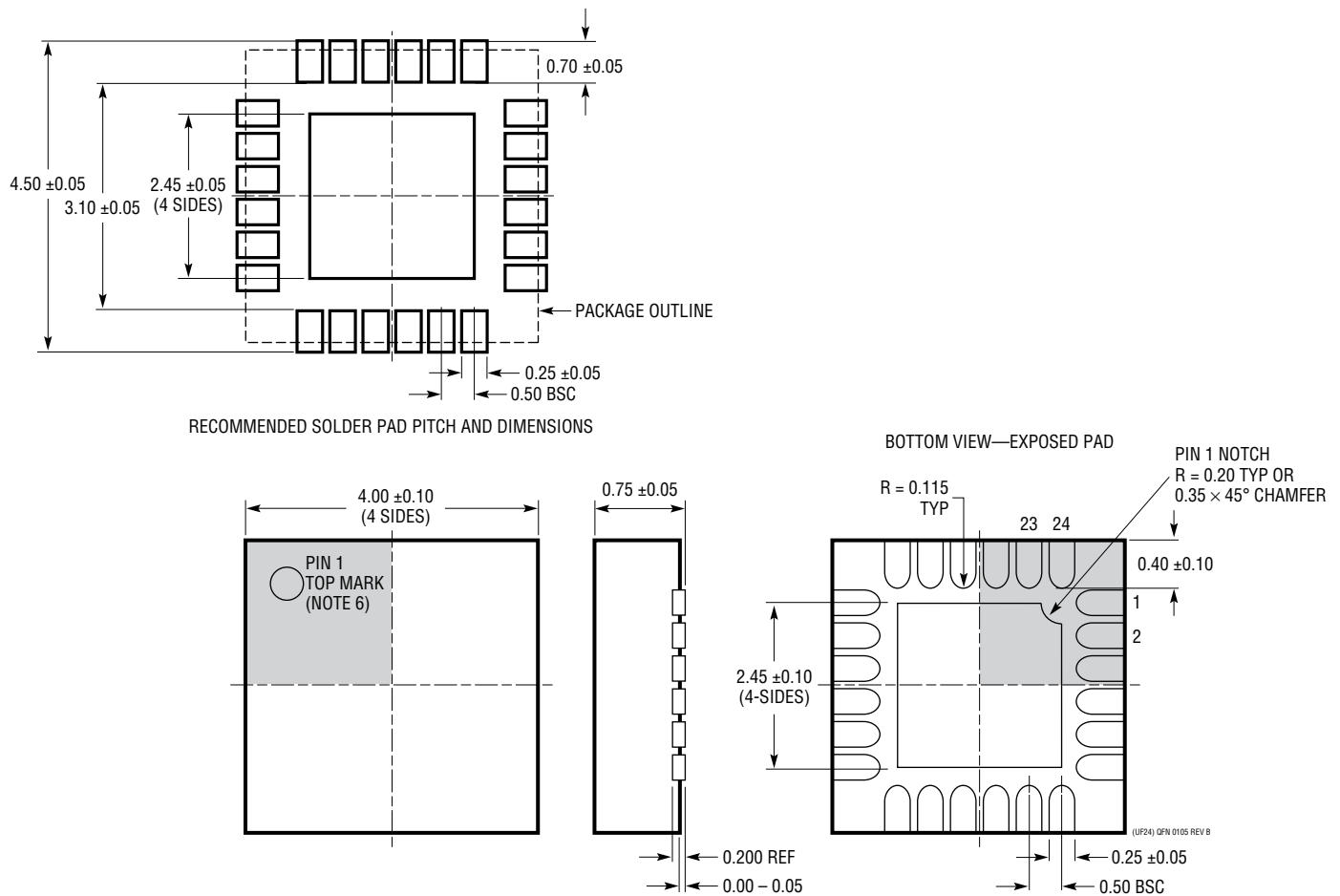

NOTE:

1. DRAWING PROPOSED TO BE MADE A JEDEC PACKAGE OUTLINE MO-220 VARIATION (WGGD-X)—TO BE APPROVED
2. DRAWING NOT TO SCALE
3. ALL DIMENSIONS ARE IN MILLIMETERS
4. DIMENSIONS OF EXPOSED PAD ON BOTTOM OF PACKAGE DO NOT INCLUDE MOLD FLASH. MOLD FLASH, IF PRESENT, SHALL NOT EXCEED 0.15mm ON ANY SIDE, IF PRESENT
5. EXPOSED PAD SHALL BE SOLDER PLATED
6. SHADED AREA IS ONLY A REFERENCE FOR PIN 1 LOCATION ON THE TOP AND BOTTOM OF PACKAGE

TYPICAL APPLICATION

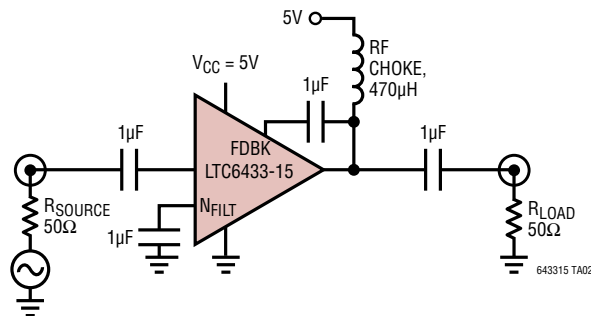

RELATED PARTS

PART NUMBER	DESCRIPTION	COMMENTS
Fixed Gain IF Amplifiers/ADC Drivers		
LTC6431-15/LTC6431-20	15dB/20dB Gain 50Ω Gain Block IF Amplifier—Single Ended	OIP3 = 47dBm at 240MHz, 20MHz to 1700MHz Bandwidth, 3.3dB/2.60dB NF
LTC6430-15/LTC6430-20	15dB/20dB Gain Block IF Amplifier—Differential	OIP3 = 50dBm at 240MHz, 20MHz to 1700MHz Bandwidth, 3.3dB/2.60dB NF
LTC6417	1.6GHz Low Noise High Linearity Differential Buffer/ADC Driver	OIP3 = 41dBm at 300MHz; Can Drive 50Ω Differential Output; High Speed Voltage Clamping Protects Subsequent Circuitry
LTC6416	2GHz, 16-Bit Differential ADC Buffer	-72dBc IM2 at 300MHz 2V _{P-P} Composite, I _S = 42mA, eN = 2.8nV/√Hz; A _V = 0dB; 300MHz
LTC6410-6	1.4GHz Differential IF Amplifier with Configurable Input Impedance	OIP3 = 36dBm at 70MHz; Flexible Interface-to-Mixer IF Port
LTC6400-8/LTC6400-14	1.8GHz Low Noise, Low Distortion Differential ADC Drivers	-71dBc IM3 at 240MHz 2V _{P-P} Composite, I _S = 90mA, A _V = 8dB/14dB/20dB/26dB
Variable Gain IF Amplifiers/ADC Drivers		
LTC6412	800MHz, 31dB Range Analog-Controlled VGA	OIP3 = 35dBm at 240MHz; Continuously Adjustable Gain Control
Baseband Differential Amplifiers		
LTC6409	1.1nV Hz Single Supply Differential/ADC Driver	88SFDR at 100MHz, AC or DC Couple Inputs
LT6411	Low Power Differential ADC Driver/Dual Selectable Gain Amplifier	-83dBc IM3 at 70MHz 2V _{P-P} Composite; A _V = 1, -1 or 2; 16mA; Excellent for Single-Ended to Differential Conversion
LTC6406	3GHz Rail-to-Rail Input Differential Amplifier/ADC Driver	-65dBc IM3 at 50MHz 2V _{P-P} Composite; Rail-to-Rail Inputs; eN = 1.6nV/√Hz; 18mA
LTC6404-1/LTC6404-2	Low Noise Rail-to-Rail Output Differential Amplifier/ADC Driver	16-Bit SNR, SFDR at 10MHz; Rail-to-Rail Outputs; eN = 1.5nV/√Hz; LTC6404-1 Is Unity-Gain Stable, LTC6404-2 Is Gain-of-Two Stable
High Speed ADCs		
LTC2107	16-Bit, 210MSPS ADCs	98.0dBFS SFDR 80dBFS Noise Floor, 2.40V _{P-P} or 1.60V _{P-P} Input
LTC2259-16	16-Bit, 80MSPS, 1.8V ADC	72.0 dBFS Noise Floor, SFDR > 82dB at 140MHz, 2.00V _{P-P} Input
LTC2160/LTC2161/ LTC2162/LTC2163/ LTC2164/LTC2165	16-Bit, 25MSPS/40MSPS/65MSPS/80MSPS/105MSPS/ 105MSPS, 1.8V ADCs	76.2 dBFS Noise Floor, SFDR > 84dB at 140MHz, 2.00V _{P-P} Input
LTC2150-14/LTC2151-14/ LTC2152-14/LTC2153-14	14-Bit, 170MSPS/210MSPS/250MSPS/310MSPS, 1.8V ADCs	Single ADCs, >68dB SNR, >88dB SFDR, 1.32V _{P-P} Input Range
LTC2208/LTC2209	16-Bit, 130MSPS/160MSPS ADCs	74.0 dBFS Noise Floor, SFDR >89dB at 140MHz, 2.25V _{P-P} Input