

## **TPS23523EVM-863 Evaluation Module**

This user's guide describes the TPS23523 evaluation module (TPS23523EVM-863). The TPS23523EVM-863 contains evaluation and reference circuitry for the TPS23523, which is a low-side *Hot Swap* and ORing controller targeted at telecom applications. In addition, this EVM contains an INA226 to demonstrate how telemetry can easily be added to this solution.

### **Contents**

1	Introduction .....	2
2	Schematic.....	5
3	General Configuration and Description .....	5
4	Test Results .....	7
5	Bill of Materials .....	16

### **List of Figures**

1	TPS23523-863 Typical Configuration .....	3
2	TPS23523-863 Advanced Configuration .....	3
3	TPS23523EVM-863 Schematic.....	5
4	Start Up ( $V_{IN} = 54\text{ V}$ ).....	7
5	Start Up ( $V_{IN} = 54\text{ V}$ ).....	7
6	Start Up ( $V_{IN} = 38\text{ V}$ ).....	7
7	Start Up ( $V_{IN} = 60\text{ V}$ ).....	7
8	Hot Plug Channel A and B Together .....	7
9	Hot Plug Channel A and B Together .....	7
10	Hot Plug A after B .....	8
11	Hot Plug A after B .....	8
12	Hot Plug A after B .....	8
13	Hot Plug A after B .....	8
14	Output Hot Short ( $V_{INB} = 54\text{ V}$ ) .....	8
15	Output Hot Short ( $V_{INB} = 54\text{ V}$ ) .....	8
16	Output Hot Short ( $V_{INB} = 54\text{ V}$ ) .....	9
17	Output Hot Short ( $V_{INB} = 60\text{ V}$ ) .....	9
18	Output Hot Short ( $V_{INB} = 60\text{ V}$ ) .....	9
19	Gradual Over Current ( $V_{INA} = 54\text{ V}$ ).....	9
20	Load Step Overcurrent.....	9
21	Start Into Short .....	9
22	Start Into Short .....	10
23	Apply Short and Remove Short .....	10
24	1-ms Brown Out .....	10
25	1-ms Brown Out .....	10
26	Supply Switch Over (Raise $V_{INA}$ ).....	10
27	Supply Switch Over (Zoomed in).....	10
28	$V_{INA}$ Short .....	11
29	$V_{INA}$ Short .....	11

30	Unplug $V_{IN}A$ .....	11
31	Plug in $V_{IN}A$ Backwards .....	11
32	Plug in $V_{IN}A$ Backwards .....	11
33	Undervoltage and Overvoltage (Rising) .....	11
34	Undervoltage and Overvoltage (Falling) .....	12
35	-2-kV (2 $\Omega$ ) Lightning Surge .....	12
36	-2-kV (2 $\Omega$ ) Lightning Surge (Zoomed in) .....	12
37	2-kV (2 $\Omega$ ) Lightning Surge (Zoomed in) .....	12
38	2-kV (2 $\Omega$ ) Lightning Surge (Zoomed in) .....	12
39	Start-Up ( $V_{IN} = 54$ V) .....	12
40	Hot Short ( $V_{IN} = 54$ V).....	13
41	Hot Short ( $V_{IN} = 38$ V).....	13
42	Load Step (0 A–11 A) .....	13
43	Load Step Into Overcurrent .....	13
44	Start Into Short .....	13
45	1-ms Brown Out .....	13
46	Effective Circuit for Voltage Monitoring.....	15

#### List of Tables

1	TPS23523 Electrical and Performance Specifications at 25°C .....	4
2	Connector Functionality .....	5
3	Test Points.....	6
4	Jumper Descriptions.....	6
5	TPS23523 EVM – Measured Voltage Monitoring Accuracy .....	14
6	TPS23523 EVM, Measured Current Monitoring Accuracy.....	15
7	Bill of Materials .....	16

## Trademarks

All trademarks are the property of their respective owners.

## 1 Introduction

The TPS23523 EVM is meant to give a jump start to anyone designing a -48-V system with a single supply that needs to support supply dips and other transients. It includes input clamping to support lightning surge (up to 2 kV), various FET placeholders to support various power levels, and an output inductor to mimic any EMI filter before the DC/DC converter. The EVM can be configured in two ways (via jumpers) to evaluate 2 common architectures seen in the -48-V telecommunication space.

[Figure 1](#) shows a block diagram for the first configuration of the EVM. The TPS23523 provides inrush control, short circuit protection, reverse current protection, and reverse hookup protection. The INA226 provides current, voltage, and power monitoring. If the downstream DC/DC is isolated and powers the microcontroller, an isolator is required to communicate between the microcontroller and the INA226. Thus, the ISO1541 is added to provide this functionality. Also note that the TPS23523 helps to create a bias rail to power both the INA226 and ISO1541. For detailed operation of the INA226, consult [INA226EVM Evaluation Board and Software Tutorial](#) .

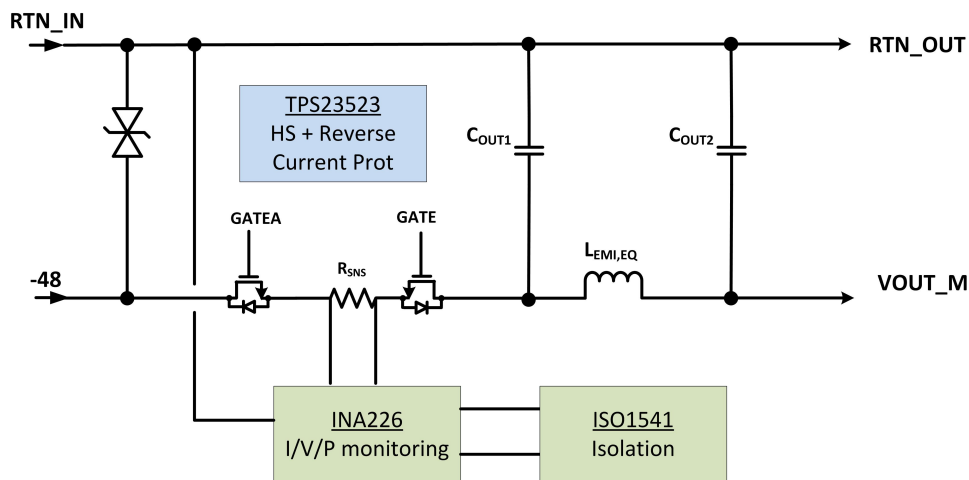

Figure 1. TPS23523-863 Typical Configuration

As Figure 2 shows, the TPS23523 EVM can also be configured to implement a more sophisticated architecture. In this architecture there is a common 48-V input that is used to power both the load on the board and the mid plane. The ORing and current monitoring is performed on the 48-V input. Then the hot-swap function is performed on just the load present on the board. The remaining current powers the mid plane, which has its own plug-in cards with hot swap on them.

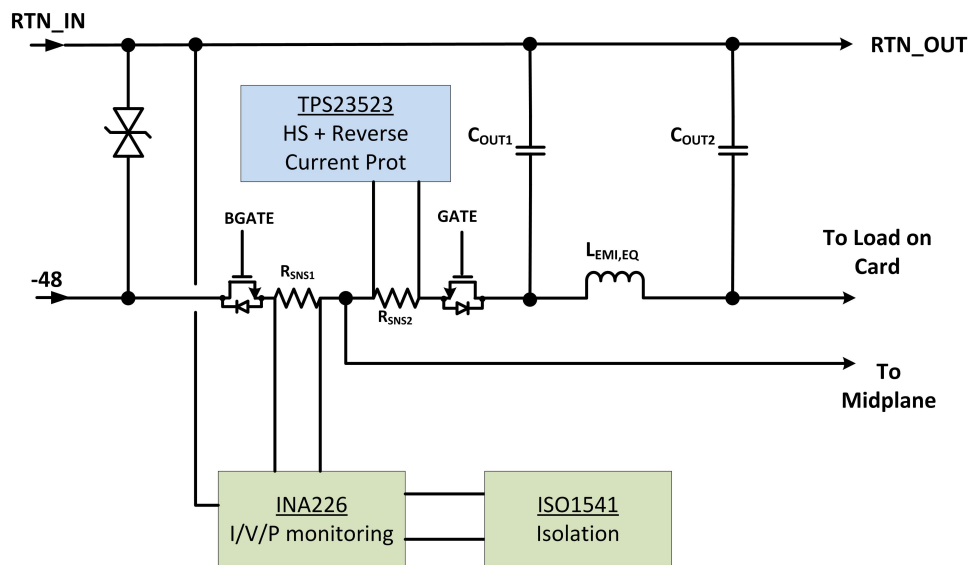

Figure 2. TPS23523-863 Advanced Configuration

## 1.1 Features

This EVM has the following features:

- Inrush current control
- Hot-swap output short-circuit protection
- Reverse current protection
- Reverse hookup protection

## 1.2 Applications

This EVM is used in the following applications:

- Wireless infrastructure
- Telecom infrastructure
- –48-V interface

## 1.3 Electrical Specifications

Table 1 lists the TPS23523 electrical and performance specifications at 25°C.

**Table 1. TPS23523 Electrical and Performance Specifications at 25°C**

Characteristic	TPS23523EVM-PWR863
Input voltage range (recommended)	38 V to 60 V
Input voltage range (absolute maximum)	0 V to 150 V
Load power	400 W
Load output capacitance	500 $\mu$ F
Current limit (normal)	12.5 A
Current limit (high FET $V_{DS}$ )	1.5 A
Typical inrush current	0.4 A
Hot-Swap FET $V_{DS}$ when current transitions from high to low	20.2 V
Time out ( $V_{DS,HS} < 10$ V)	2.25 ms
Time out ( $10$ V $< V_{DS,HS} < 20$ V)	1.12 ms
Time out ( $V_{DS,HS} > 20$ V)	0.23 ms
Undervoltage threshold (rising)	36.6 V
Undervoltage threshold (falling)	34.6 V
Overvoltage (OV) threshold (rising)	64.4 V
Overvoltage threshold (falling)	61.4 V

## 2 Schematic

Figure 3 illustrates the EVM schematic.

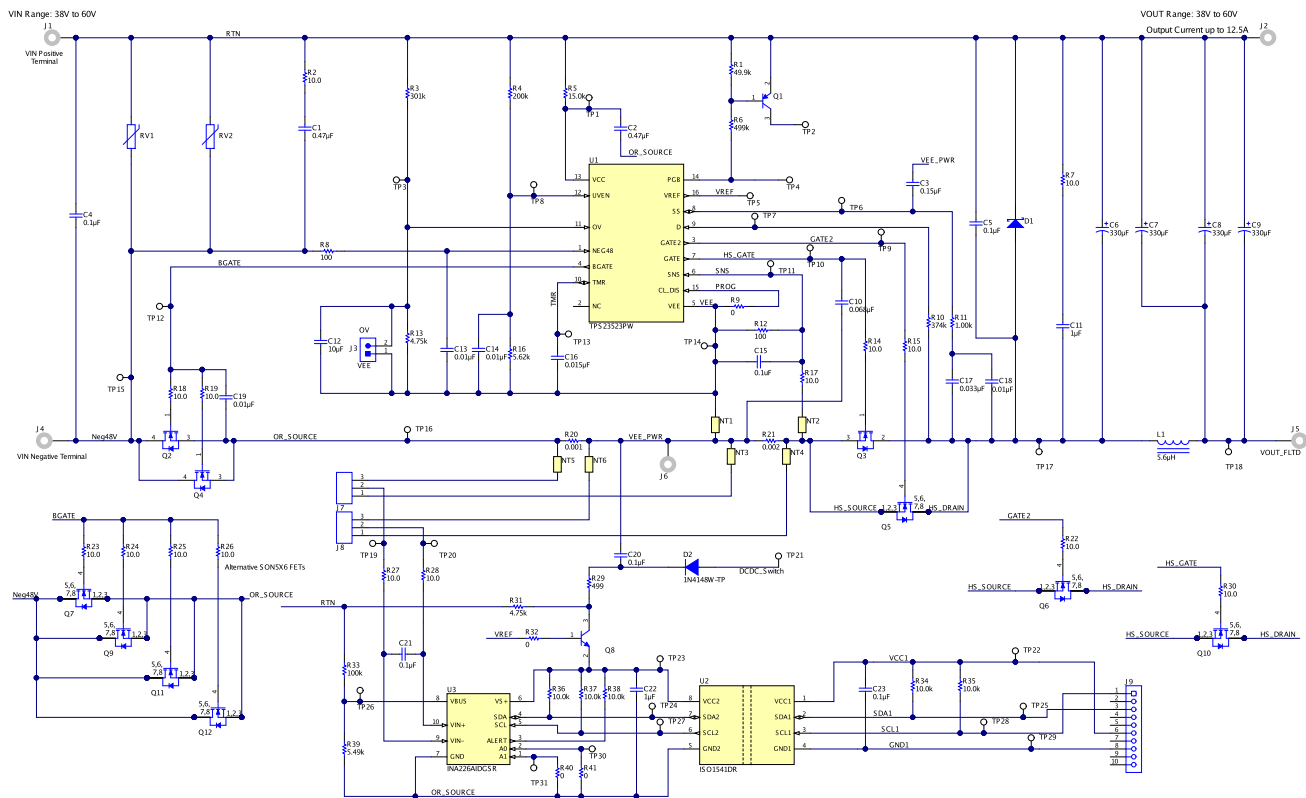

Copyright © 2017, Texas Instruments Incorporated

Figure 3. TPS23523EVM-863 Schematic

## 3 General Configuration and Description

### 3.1 Physical Access

Table 2 lists the TPS23523EVM connector and functionality, Table 3 describes the test point availability, and Table 4 describes the default jumper configuration.

Table 2. Connector Functionality

Connector	Label	Description
J1, J2	RTN	Power bus input – tie the high side of the power-supply inputs and outputs here.
J3		Overvoltage jumper – shorts OV to GND disabling OV.
J4	Neg48V	Neg48V input – tie the low side of the input supply here.
J5	Vout_FLTD	Output bus – low-side output after EMI inductor.
J6	VEE_PWR	Tie Extra loads here to test advanced configuration.
J7		Jumper selects current monitoring between R20 and R21.
J8		Jumper selects current monitoring between R20 and R21.
J9		Connector for the INA dongle.

**Table 3. Test Points**

Connector	Label	Description
TP1	VCC	Clamped voltage supply
TP2	PGB_Col	PGB test point
TP3	OV	OV pin voltage
TP4	PGB	Power good bar
TP5	VREF	External voltage reference pin
TP6	SS	Soft-start pin voltage
TP7	D	D pin voltage
TP8	UVEN	UV pin voltage
TP9	GATE2	Gate-drive output voltage for optional hot-swap FET Q5
TP10	GATE	Gate-drive output voltage for hot-swap FET Q3
TP11	SNS	Sense pin test point
TP12	GATEB	Gate-drive output voltage for gate B ORing FET
TP13	TMR	Timer capacitor voltage
TP14	VEE	IC ground – place voltage probe ground at this pin
TP15	Neg48	Low-side input for power supply
TP16	OR_SRC	Main power rail test point
TP17	VOUT_	Low side unfiltered output for load
TP18	VOUT_FLTD	Low side filtered output for load
TP19	SNS-	Negative side of Rsns
TP20	SNS+	Positive side of Rsns
TP21	VCC_EXT	External bias voltage
TP22	VCC1	VCC from external connector J9 to DC/DC
TP23	VCC2	VCC between INA226 telemetry and DC/DC
TP24	SDA2	Data communication between INA226 telemetry and DC/DC
TP25	SDA1	Data communication between external connector J9 and DC/DC
TP26	VBUS	Bus voltage input for INA226
TP27	SCL2	Serial bus clock line from DC/DC to INA226
TP28	SCL1	Serial bus clock line from external connector J9 to DC/DC
TP29	GND	GND from external connector J9 to DC/DC
TP30	A0	Address pin – connect to GND, SCL, or SDA. Consult <a href="#">High-or Low-Side Measurement, Bi-Directional CURRENT/POWER MONITOR with I2C™ Interface</a> for more information.
TP31	A1	Address pin – connect to GND, SCL, or SDA. Consult <a href="#">High-or Low-Side Measurement, Bi-Directional CURRENT/POWER MONITOR with I2C™ Interface</a> for more information.

**Table 4. Jumper Descriptions**

Connector	Description
J3	Overvoltage jumper – jump pins to short OV to GND, disabling OV.
J7	Jump pins 1-2 to enable R21, or jump pins 2-3 to enable R20.
J8	Jump pins 1-2 to enable R21, or jump pins 2-3 to enable R20.

### 3.2 Equipment Setup

Use the following equipment list and setup steps to work with the EVM:

- 2x power supplies capable of  $\geq 60\text{ V}$  and  $\geq 15\text{ A}$  (preferred)
- Resistive or electronic load, only turn on the load after hot swap is up

Follow these steps to properly set-up the device:

1. Set the input power-supply voltage to the desired operating input voltage.
2. Turn the power supply off.
3. Jump pins on J7 and J8, depending on the desired resistor.
4. Leave pins 1-2 on J3 open.
5. Connect the positive voltage lead from the power supply to J1 (RTN). Connect the ground lead from the power supply to J4 (Neg48V).
6. Make sure all voltmeter and oscilloscope GNDs are tied to VEE.
7. Turn the power supplies on.

### 3.3 Scope Considerations

Observe the following scope considerations:

- Most scopes have a 10-M $\Omega$  resistance between scope GND and probe. If a scope GND is tied to RTN, and a probe is placed on TMR that is approximately 5  $\mu\text{A}$  of pullup current, this can overpower the pulldown of the TMR pin and result in a time out.
- Scope GND is tied to Earth GND, which has some capacitance to supply (+) and (-) terminals. This may cause system noise.

## 4 Test Results

This section provides typical performance waveforms for the TPS23523EVM-863. Actual performance data is affected by measurement techniques and environmental variables; therefore, these curves are presented for reference and may differ from actual results obtained.

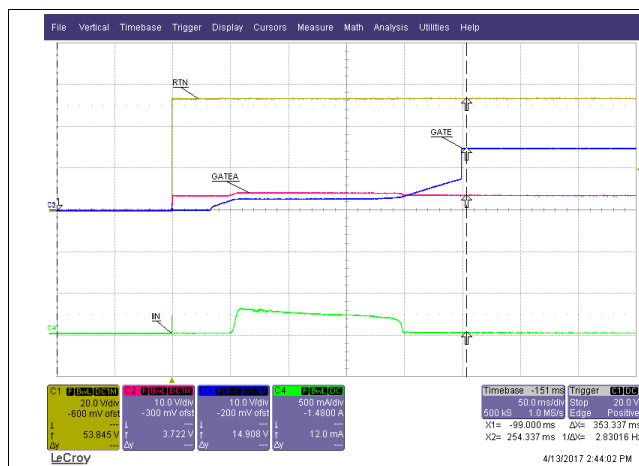

No load, scope GND = -48V\_A

Figure 4. Start Up ( $V_{IN} = 54\text{ V}$ )

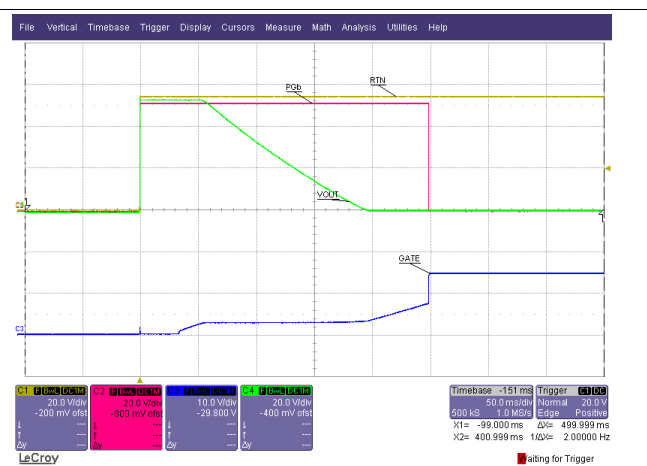

No load, scope GND = -48V\_A

Figure 5. Start Up ( $V_{IN} = 54\text{ V}$ )

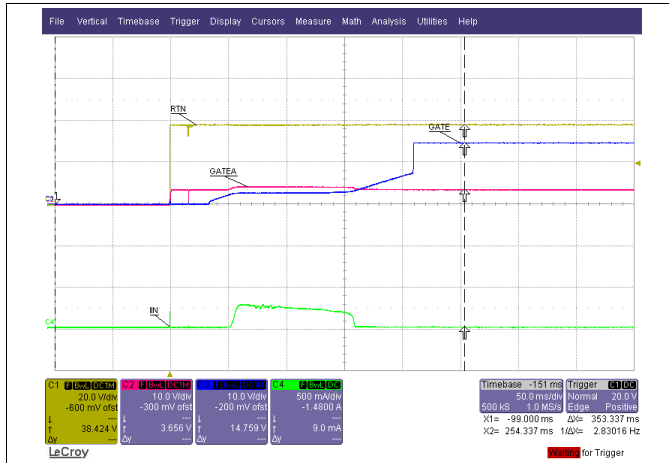

No load, scope GND = -48V\_A

Figure 6. Start Up ( $V_{IN} = 38\text{ V}$ )

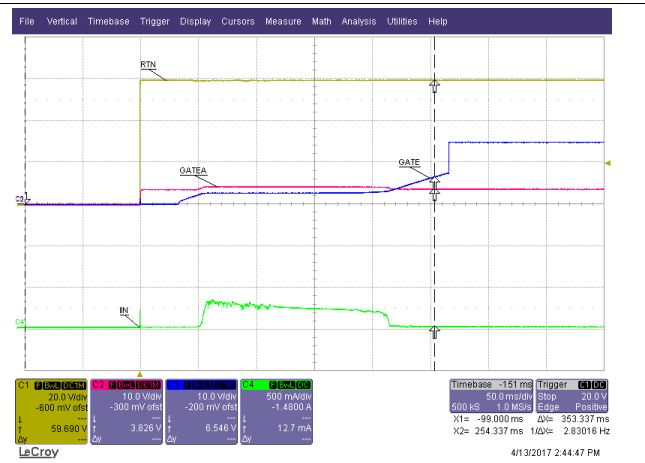

No load, scope GND = -48V\_A

Figure 7. Start Up ( $V_{IN} = 60\text{ V}$ )

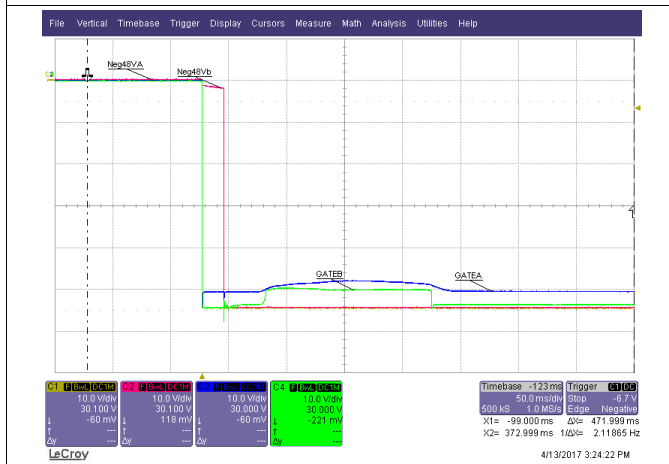

$V_{IN,A} = 54\text{ V}$ ,  $V_{IN,B} = 54\text{ V}$ , no load, scope GND = RTN

Figure 8. Hot Plug Channel A and B Together

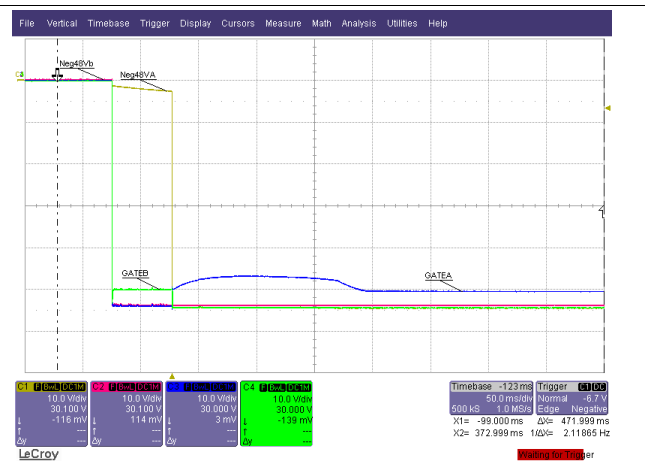

$V_{IN,A} = 54.5\text{ V}$ ,  $V_{IN,B} = 54\text{ V}$ , no load, scope GND = RTN

Figure 9. Hot Plug Channel A and B Together

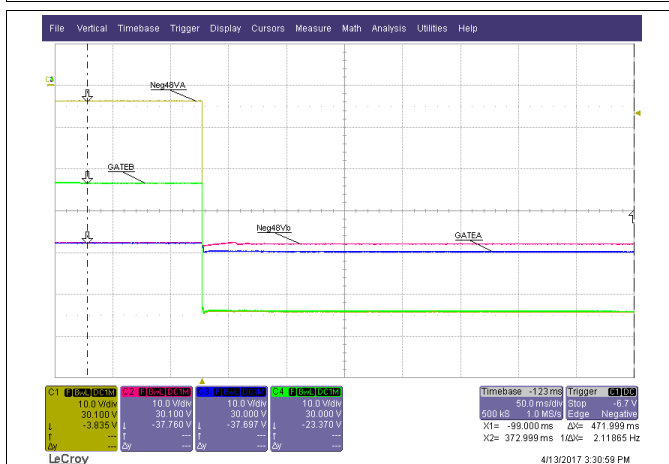

$V_{IN,A} = 54\text{ V}$ ;  $V_{IN,B} = 38\text{ V}$ , scope GND = RTN, Iload = 5 A

Figure 10. Hot Plug A after B



$V_{IN,A} = 54\text{ V}$ ;  $V_{IN,B} = 38\text{ V}$ , scope GND = RTN, Iload = 5 A

Figure 11. Hot Plug A after B



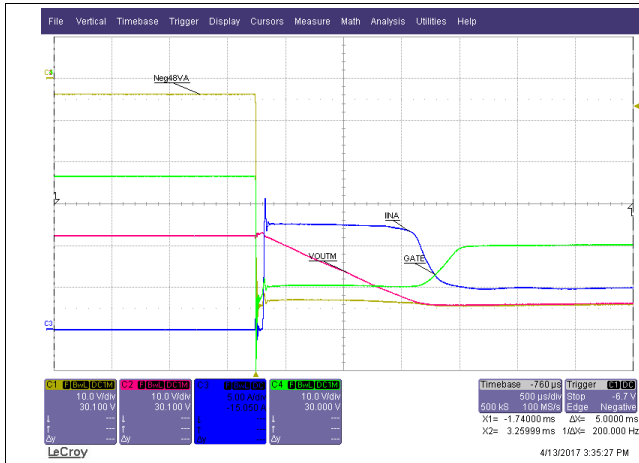

$V_{IN_A} = 54\text{ V}$ ;  $V_{IN_B} = 38\text{ V}$ , scope GND = RTN, Iload = 5 A

Figure 12. Hot Plug A after B

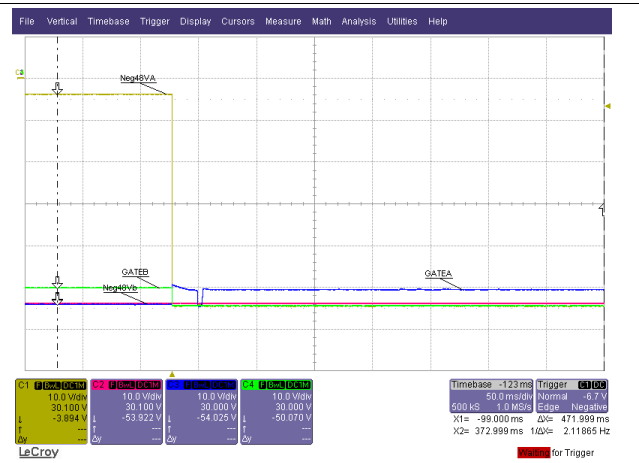

$V_{IN_A} = 54.5\text{ V}$ ;  $V_{IN_B} = 54\text{ V}$ , scope GND = RTN, no load

Figure 13. Hot Plug A after B

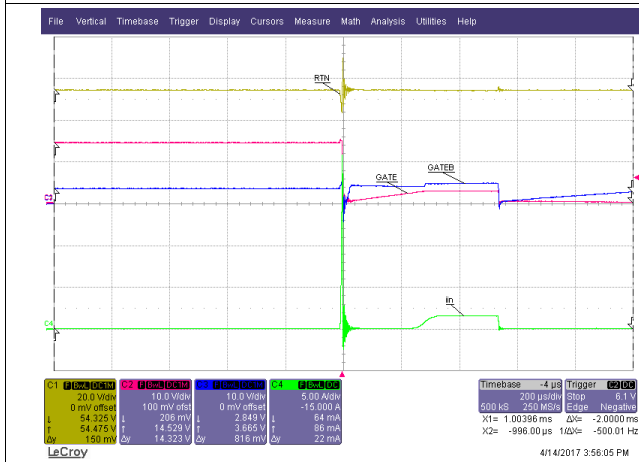

Scope GND = -48V\_B, no load, after inductor

Figure 14. Output Hot Short ( $V_{IN_B} = 54\text{ V}$ )

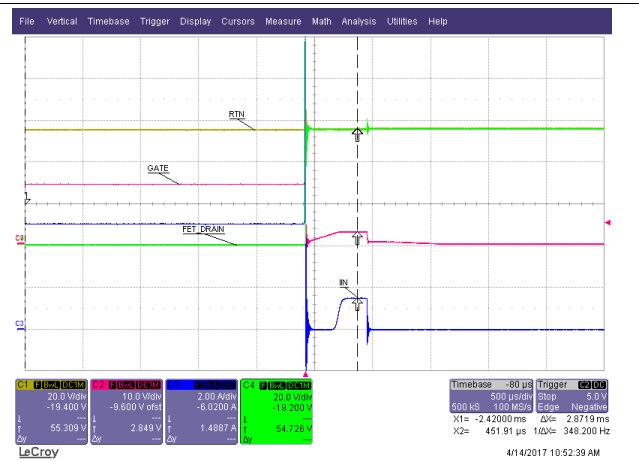

Scope GND = -48V\_B, 5-A load, after inductor

Figure 15. Output Hot Short ( $V_{IN_B} = 54\text{ V}$ )



Scope GND = -48V\_B, 5A load, zoomed in

Figure 16. Output Hot Short ( $V_{IN_B} = 54\text{ V}$ )



Scope GND = -48V\_B, 5-A load

Figure 17. Output Hot Short ( $V_{IN_B} = 60\text{ V}$ )



Scope GND = -48V\_B, 5-A load, zoomed in

Figure 18. Output Hot Short ( $V_{INB} = 60\text{ V}$ )

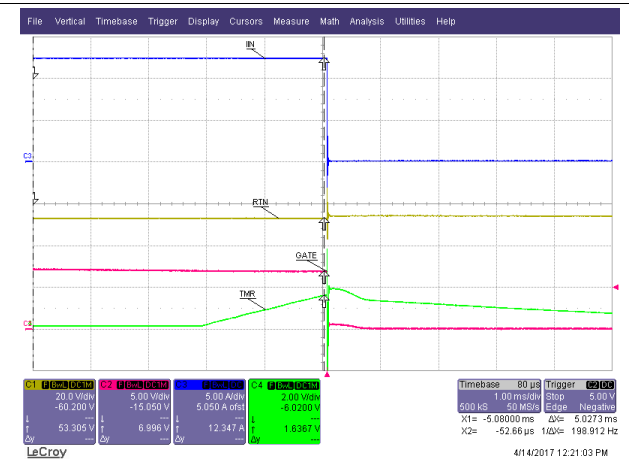

Scope GND = -48V\_A

Figure 19. Gradual Over Current ( $V_{INA} = 54\text{ V}$ )

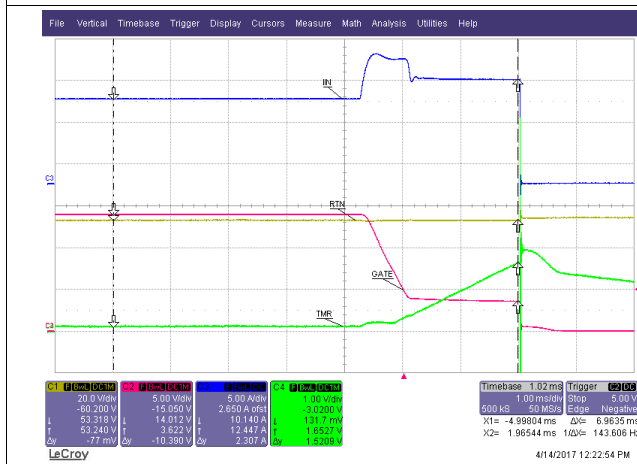

Scope GND = -48V\_A

Figure 20. Load Step Overcurrent

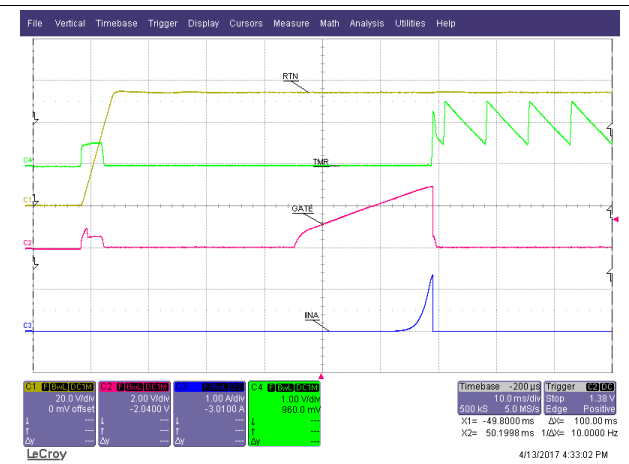

Scope GND = -48V\_A,  $V_{IN} = 54\text{ V}$

Figure 21. Start Into Short



Scope GND = -48V\_A,  $V_{IN} = 54\text{ V}$

Figure 22. Start Into Short



Scope Gnd = -48V\_A,  $V_{IN} = 54\text{ V}$

Figure 23. Apply Short and Remove Short

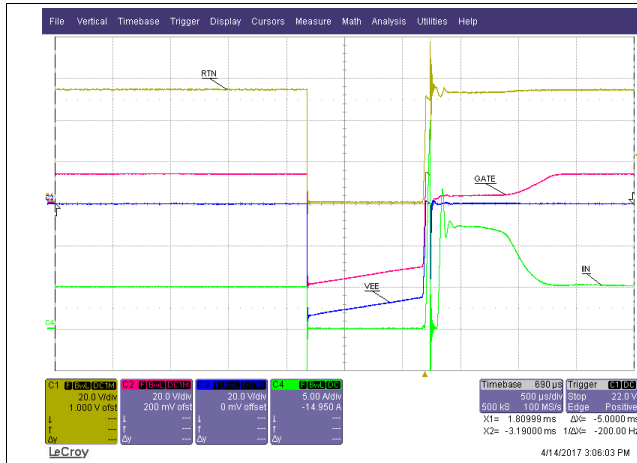

Scope GND = -48V\_A, Iload = 5 A

Figure 24. 1-ms Brown Out

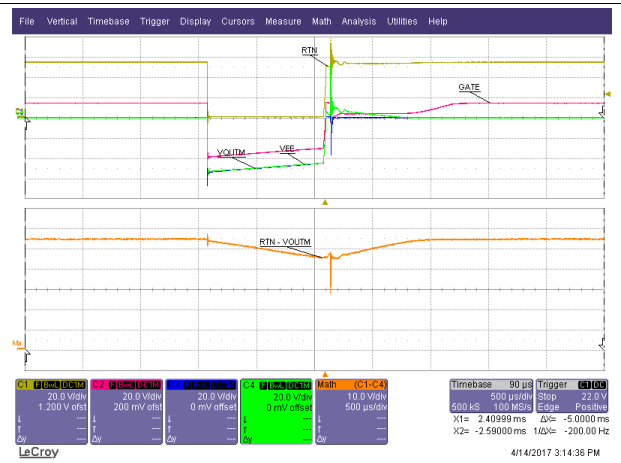

Scope GND = -48V\_A, Iload = 5 A

Figure 25. 1-ms Brown Out



$V_{INB} = 53\text{ V}$ , Iload = 5 A, scope GND = RTN

Figure 26. Supply Switch Over (Raise  $V_{IN}$ )



$V_{INB} = 53\text{ V}$  (raise  $V_{INA}$ ), scope GND = RTN, Iload = 5 A

Figure 27. Supply Switch Over (Zoomed in)

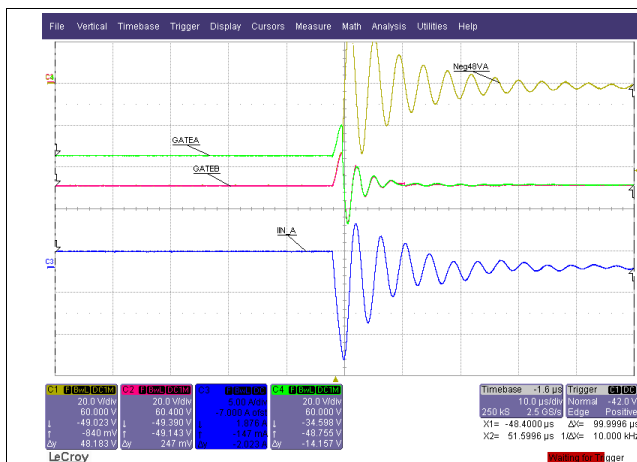

$V_{INA} = 54.5\text{ V}$ ;  $V_{INB} = 54\text{ V}$ , Iload = 5 A, scope GND = RTN

Figure 28.  $V_{IN}$  A Short

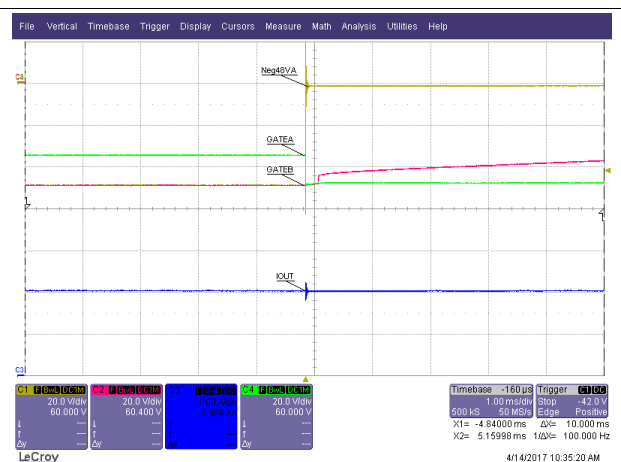

$V_{INA} = 54.5\text{ V}$ ;  $V_{INB} = 54\text{ V}$ , Iload = 5 A, scope GND=RTN

Figure 29.  $V_{IN}$  A Short

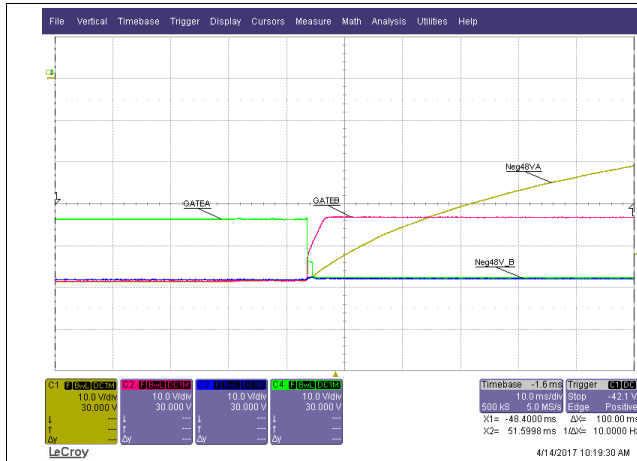

$V_{IN,A} = 54.5 \text{ V}$ ;  $V_{IN,B} = 54 \text{ V}$ , Iload = 5 A, scope GND=RTN

Figure 30. Unplug  $V_{IN,A}$

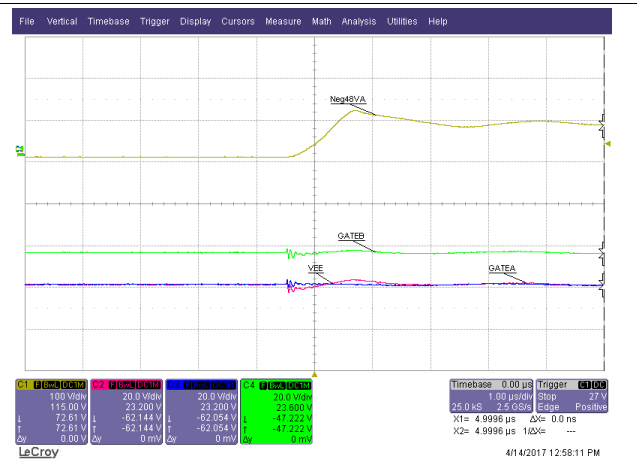

$V_{IN,B} = 60 \text{ V}$

Figure 31. Plug in  $V_{IN,A}$  Backwards

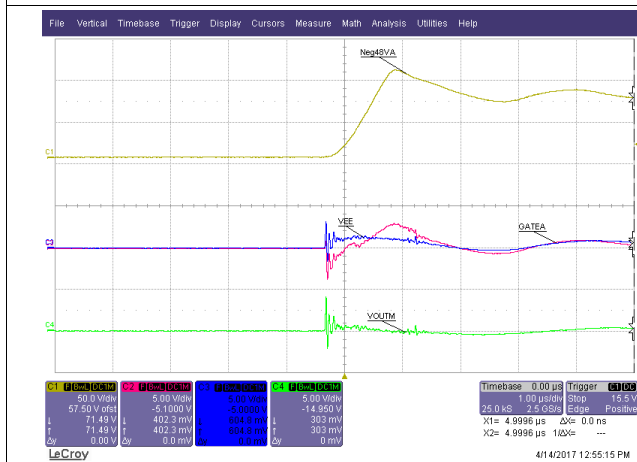

$V_{IN,B}$  floating

Figure 32. Plug in  $V_{IN,A}$  Backwards

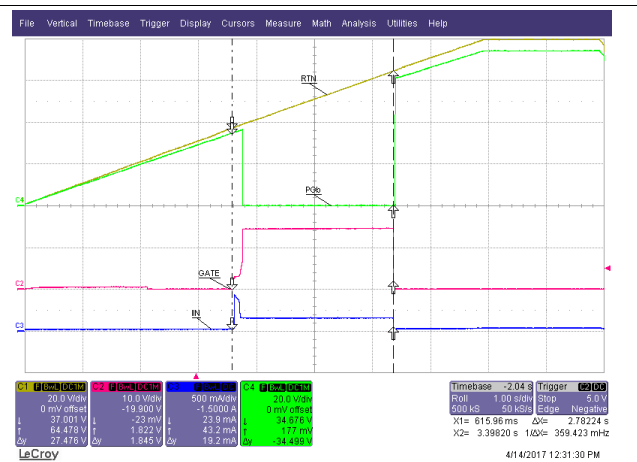

Scope GND = -48V\_A, no load

Figure 33. Undervoltage and Overvoltage (Rising)



Scope GND = -48V\_A, no load

Figure 34. Undervoltage and Overvoltage (Falling)

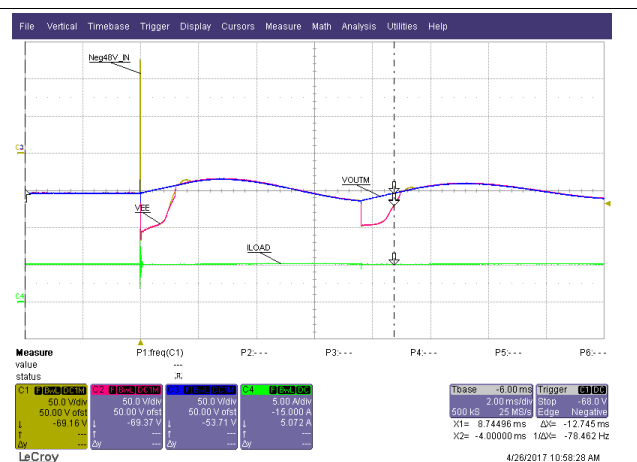

Scope GND = RTN, 5-A load, Per IEC61000-4-5

Figure 35. -2-kV (2 Ω) Lightning Surge

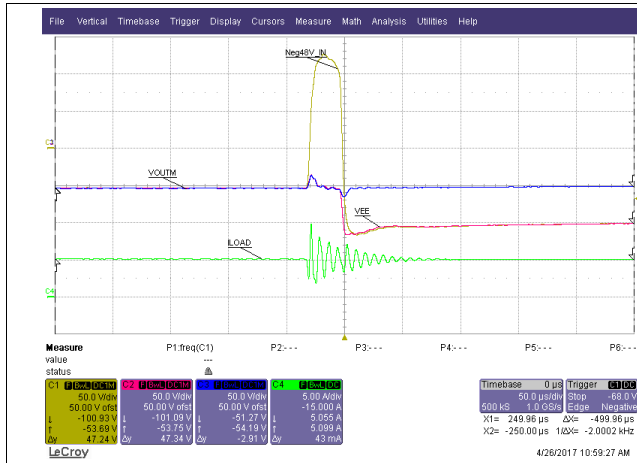

Scope GND = RTN, 5-A load, Per IEC61000-4-5

Figure 36. -2-kV (2 Ω) Lightning Surge (Zoomed in)

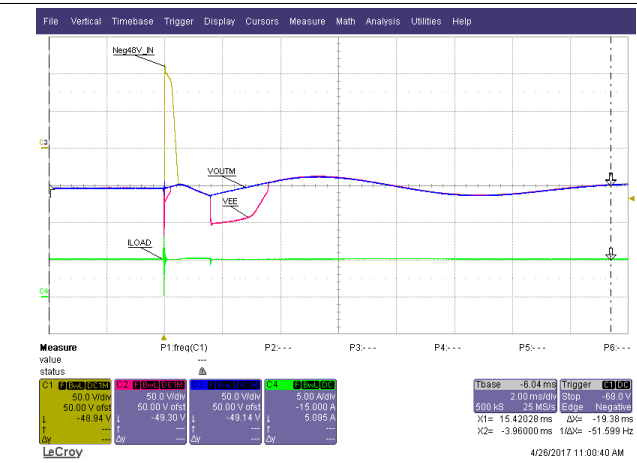

Scope GND = RTN, 5-A load, Per IEC61000-4-5

Figure 37. 2-kV (2 Ω) Lightning Surge (Zoomed in)

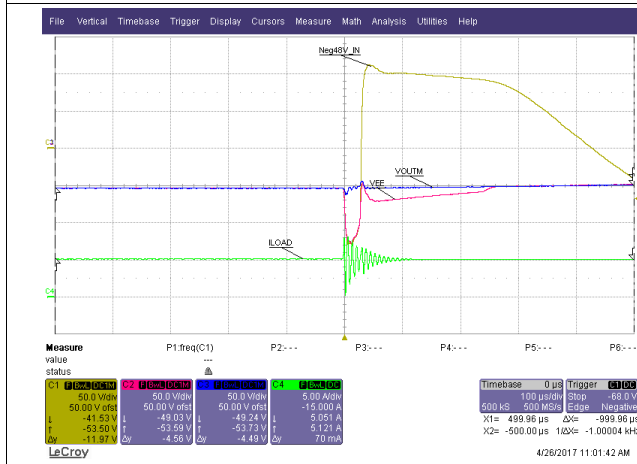

Scope GND = RTN, 5-A load, Per IEC61000-4-5

Figure 38. 2-kV (2 Ω) Lightning Surge (Zoomed in)

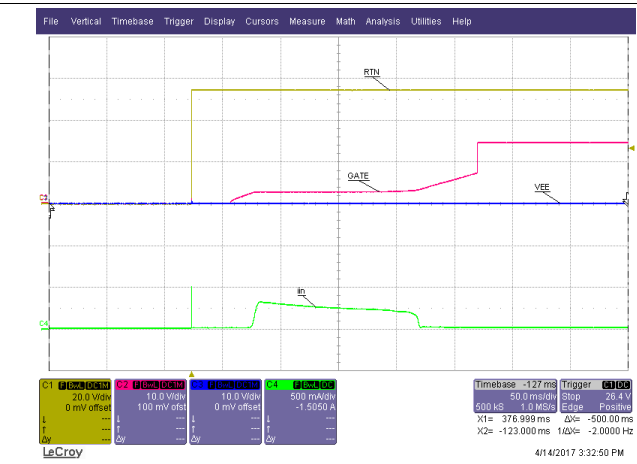

Lin = 20 μH, scope GND = -48V\_A

Figure 39. Start-Up ( $V_{IN} = 54 V$ )

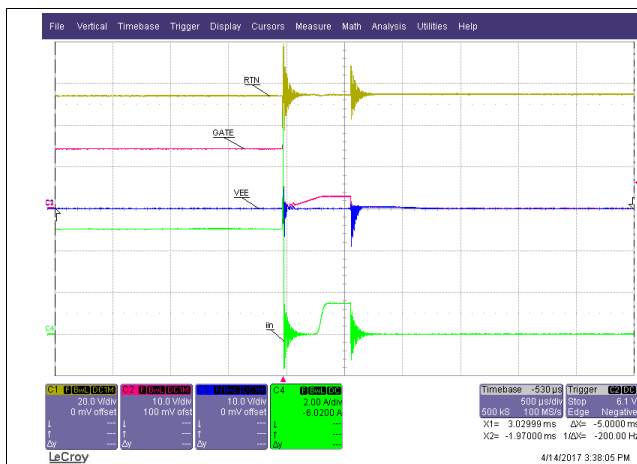

Lin = 20 μH, scope GND = -48V\_A

Figure 40. Hot Short ( $V_{IN} = 54 V$ )

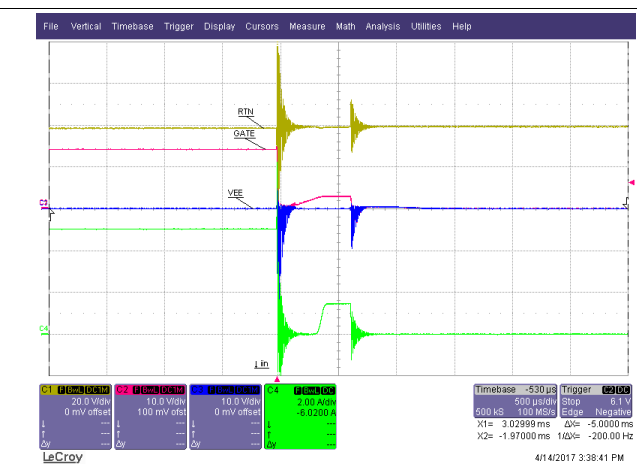

Lin = 20 μH, scope GND = -48V\_A

Figure 41. Hot Short ( $V_{IN} = 38 V$ )

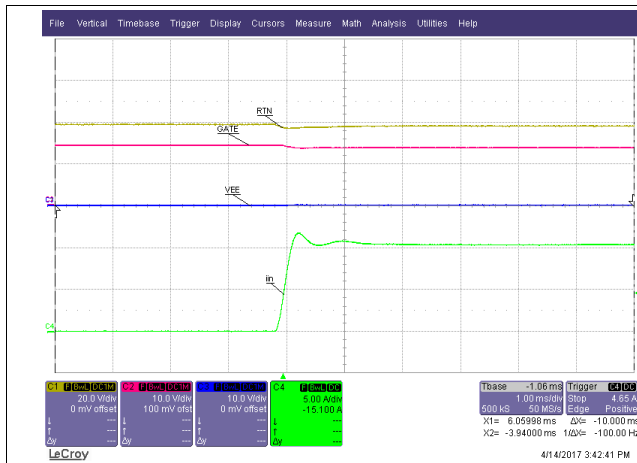

Lin = 20  $\mu$ H, scope GND = -48V\_A,

Figure 42. Load Step (0 A–11 A)

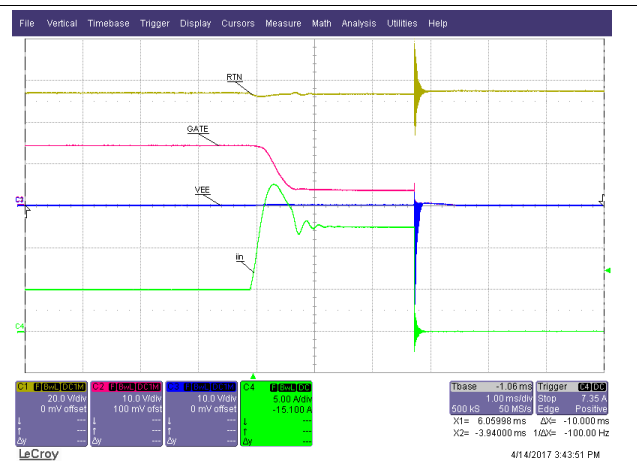

Lin = 20  $\mu$ H, scope GND = -48V\_A

Figure 43. Load Step Into Overcurrent

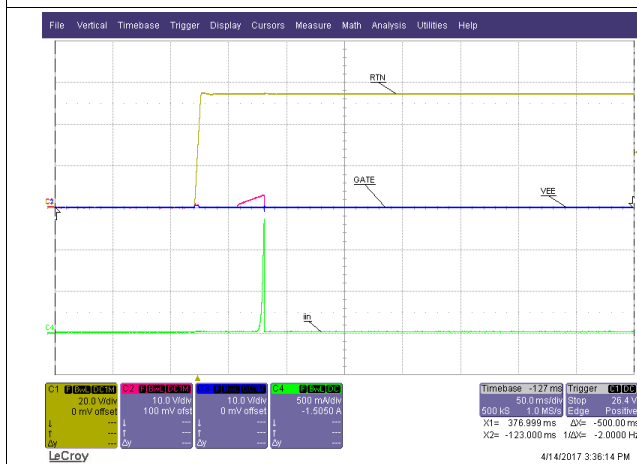

Lin = 20  $\mu$ H, scope GND = -48V\_A

Figure 44. Start Into Short

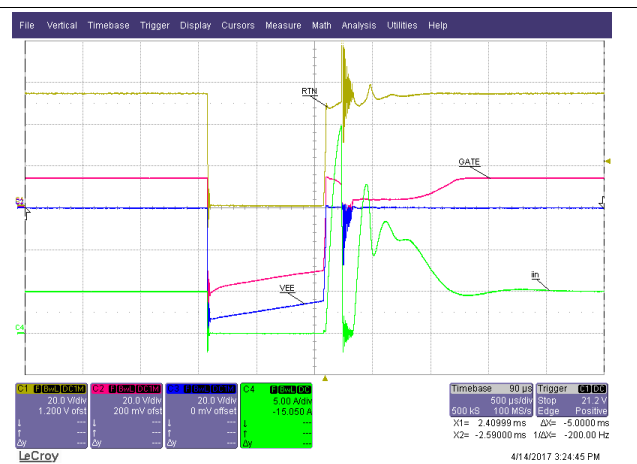

Lin = 20  $\mu$ H, scope GND = -48V\_A

Figure 45. 1-ms Brown Out

The *TPS23523 EVM – Measured Voltage Monitoring Accuracy* table shows excellent voltage monitoring accuracy was achieved.

Table 5. TPS23523 EVM – Measured Voltage Monitoring Accuracy

$V_{IN, ACT}(V)$	$V_{BUS, ACT}(V)$	$V_{IN, MEAS}(V)$	Error
38.48	1.989	38.46	-0.05%
47.98	2.481	47.97	-0.02%
58.48	3.024	58.47	-0.02%

The INA226 measures the voltage on the  $V_{BUS}$  pin, which is tied to  $V_{IN}$  through a resistor divider. Figure 46 illustrates a simplified diagram. Note that there is an 830-k $\Omega$  resistor that must be accounted for. For this EVM,  $R_1 = 100$  k $\Omega$  and  $R_2 = 5.49$  k $\Omega$ . To compute  $V_{IN, MEAS}$  from  $V_{BUS, MEAS}$  measured, first compute  $R_{BOT}$  and then compute the resistor divider ratio as follows:

$$R_{BOT} = R_2 \parallel R_{INT} = \frac{R_2 \times R_{INT}}{R_2 + R_{INT}} = \frac{5.49 \text{ k}\Omega \times 830 \text{ k}\Omega}{5.49 \text{ k}\Omega + 830 \text{ k}\Omega} = 5.454 \text{ k}\Omega \quad (1)$$

$$\frac{V_{IN}}{V_{BUS}} = \frac{R_{BOT} + R_1}{R_1} = \frac{5.454 \text{ k}\Omega + 100 \text{ k}\Omega}{5.454 \text{ k}\Omega} = 19.335 \quad (2)$$

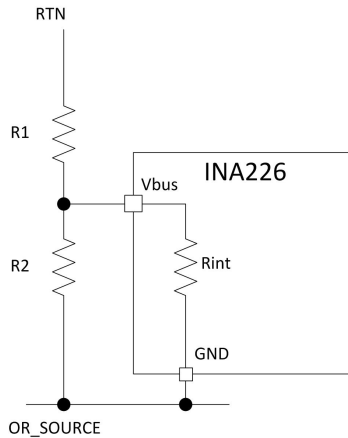

Figure 46. Effective Circuit for Voltage Monitoring

Table 6 shows the current monitoring accuracy results. The VSNS was measured between TP19 and TP7, which is before the RC filter going into the IC. The results show that the sense resistor is responsible for the majority of the error and roughly equals 2%. Note that on this PCB, a simple two-terminal, 2-m $\Omega$  resistor was used. If greater accuracy is desired, 4-terminal resistors or higher-accuracy resistors can be used. Note that the *IC + Other Error* sources are 0.5% at 1 A and down to 0.1% at 10 A.

Table 6. TPS23523 EVM, Measured Current Monitoring Accuracy

IIN, ACT	VSNS, ACT (mV)	VSNS, MEAS (mV)	IIN, MEAS (A)	RSNS, ERROR	IC + Other Error	Total Error
1	2.035	2.025	1.0125	1.8%	-0.49%	1.25%
2	4.08	4.07	2.035	1.9%	-0.25%	1.65%
3	6.125	6.11	3.055	2.1%	-0.25%	1.83%%
4	8.17	8.153	4.0765	2.1%	-0.21%	1.91%
5	10.21	10.19	5.095	2.1%	-0.20%	1.90%
6	12.22	12.19	6.095	1.8%	-0.25%	1.58%
7	14.27	14.25	7.125	1.9%	-0.14%	1.79%
8	16.34	16.32	8.16	2.1%	-0.12%	2.00%
9	18.38	18.36	9.18	2.1%	-0.11%	2.00%
10	20.4	20.38	10.19	2.0%	-0.10%	13.22%

## 5 Bill of Materials

Table 7 lists the EVM BOM.

**Table 7. Bill of Materials**

Designator	Qty	Value	Description	Package Reference	Part Number	Manufacturer
PCB	1		Printed Circuit Board		PWR863	Any
C2	1	0.47uF	CAP, CERM, 0.47 $\mu$ F, 25 V, $\pm$ 10%, X7R, AEC-Q200 Grade 1, 0603	0603	GCM188R71E474KA64D	Murata
C3	1	0.15uF	CAP, CERM, 0.15 $\mu$ F, 25 V, $\pm$ 10%, X7R, 0603	0603	GRM188R71E154KA01D	Murata
C5, C20	2	0.1uF	CAP, CERM, 0.1 $\mu$ F, 100 V, $\pm$ 10%, X7R, 0805	0805	C0805C104K1RACTU	Kemet
C8, C9	2	330uF	CAP, AL, 330 $\mu$ F, 100 V, $\pm$ 20%, 0.153 ohm, SMD	SMT Radial K16	EEV-FK2A331M	Panasonic
C11	1	1uF	CAP, CERM, 1 $\mu$ F, 100 V, $\pm$ 10%, X7R, 1206	1206	C3216X7R2A105K160AA	TDK
C16	1	0.015uF	CAP, CERM, 0.015 $\mu$ F, 25 V, $\pm$ 10%, X7R, 0603	0603	GRM188R71E153KA01D	Murata
C17	1	0.033uF	CAP, CERM, 0.033 $\mu$ F, 100 V, $\pm$ 10%, X7R, 0805	0805	08051C333KAT2A	AVX
C18	1	0.01uF	CAP, CERM, 0.01 $\mu$ F, 100 V, $\pm$ 5%, X7R, 0805	0805	08051C103JAT2A	AVX
C21, C23	2	0.1uF	CAP, CERM, 0.1 $\mu$ F, 10 V, $\pm$ 10%, X7R, 0603	0603	C0603C104K8RACTU	Kemet
C22	1	1uF	CAP, CERM, 1 $\mu$ F, 10 V, +80/-20%, Y5V, 0603	0603	C0603C105Z8VACTU	Kemet
D1	1	150V	Diode, Schottky, 150 V, 1 A, SMA	SMA	STPS1150A	STMicroelectronics
D2	1	100V	Diode, Switching, 100 V, 0.15 A, SOD-123	SOD-123	1N4148W-TP	Micro Commercial Components
H1, H2, H3, H4	4		Machine Screw, Round, #4-40 x 1/4, Nylon, Philips panhead	Screw	NY PMS 440 0025 PH	B&F Fastener Supply
H5, H6, H7, H8	4		Standoff, Hex, 0.5"L #4-40 Nylon	Standoff	1902C	Keystone
J1	1		Standard Banana Jack, Uninsulated, 8.9mm	Keystone575-8		Keystone
J2, J4, J5, J6	4		Standard Banana Jack, Uninsulated, 8.9mm	Keystone575-8	575-8	Keystone
J3	1		Header, 100mil, 2x1, Gold, TH	2x1 Header	TSW-102-07-G-S	Samtec
J7, J8	2		Header, 100mil, 3x1, Gold, TH	PBC03SAAN	PBC03SAAN	Sullins Connector Solutions
J9	1		Receptacle, 50mil, 10x1, Gold, R/A, TH	receptacle 10x1, 50mil	851-43-010-20-001000	Mill-Max
L1	1	5.6uH	Inductor, Shielded Drum Core, Mn-Zn, 5.6 $\mu$ H, 25 A, 0.00274 ohm, SMD	18.3x8.9x18.2mm	7443557560	Würth Elektronik
Q1	1	150 V	Transistor, PNP, 150 V, 0.5 A, SOT-23	SOT-23	MMBT5401LT1G	ON Semiconductor
Q3	1	100V	MOSFET, N-CH, 100 V, 197 A, TO-263-2	KTT0002A	CSD19535KTT	Texas Instruments
Q7, Q11	2	200V	MOSFET, N-CH, 200 V, 36 A, PG-TDSON-8	PG-TDSON-8	BSC320N20NS3GATMA1	Infineon Technologies



Table 7. Bill of Materials (continued)

Designator	Qty	Value	Description	Package Reference	Part Number	Manufacturer
Q8	1	140 V	Transistor, NPN, 140 V, 0.6 A, SOT-23	SOT-23	MMBT5550LT1G	ON Semiconductor
R1	1	49.9k	RES, 49.9 k, 0.1%, 0.1 W, 0603	0603	RT0603BRD0749K9L	Yageo America
R3	1	301k	RES, 301 k, 1%, 0.125 W, 0805	0805	ERJ-6ENF3013V	Panasonic
R4	1	200k	RES, 200 k, 1%, 0.125 W, 0805	0805	CRCW0805200KFKEA	Vishay-Dale
R5	1	15.0k	RES, 15.0 k, 1%, 0.75 W, AEC-Q200 Grade 0, 2010	2010	CRCW201015K0FKEF	Vishay-Dale
R6	1	499k	RES, 499 k, 1%, 0.125 W, 0805	0805	CRCW0805499KFKEA	Vishay-Dale
R7	1	10.0	RES, 10.0, 1%, 0.25 W, 1206	1206	RC1206FR-0710RL	Yageo America
R8	1	100	RES, 100, 1%, 0.1 W, 0603	0603	CRCW0603100RFKEA	Vishay-Dale
R10	1	374k	RES, 374 k, 1%, 0.1 W, 0603	0603	RC0603FR-07374KL	Yageo America
R11	1	1.00k	RES, 1.00 k, 1%, 0.1 W, 0603	0603	CRCW06031K00FKEA	Vishay-Dale
R13	1	4.75k	RES, 4.75 k, 1%, 0.1 W, 0603	0603	CRCW06034K75FKEA	Vishay-Dale
R14, R23, R25	3	10.0	RES, 10.0 ohm, 1%, 0.1W, 0603	0603	CRCW060310R0FKEA	Vishay-Dale
R16	1	5.62k	RES, 5.62 k, 1%, 0.1 W, 0603	0603	CRCW06035K62FKEA	Vishay-Dale
R17, R27, R28	3	10.0	RES, 10.0, 1%, 0.1 W, 0603	0603	CRCW060310R0FKEA	Vishay-Dale
R20	1	0.001	RES, 0.001, 1%, 1 W, 2512	2512	ERJ-M1WTF1M0U	Panasonic
R21	1	0.002	RES, 0.002, 1%, 1 W, 2512	2512	ERJ-M1WTF2M0U	Panasonic
R31	1	4.75k	RES, 4.75 k, 1%, 0.25 W, 1206	1206	ERJ-8ENF4751V	Panasonic
R32, R40, R41	3	0	RES, 0, 5%, 0.1 W, 0603	0603	ERJ-3GEY0R00V	Panasonic
R33	1	100k	RES, 100 k, 0.1%, 0.1 W, AEC-Q200 Grade 0, 0603	0603	ERA-3AEB104V	Panasonic
R34, R35, R36, R37, R38	5	10.0k	RES, 10.0 k, 1%, 0.1 W, 0603	0603	CRCW060310K0FKEA	Vishay-Dale
R39	1	5.49k	RES, 5.49 k, 0.1%, 0.1 W, AEC-Q200 Grade 0, 0603	0603	ERA-3AEB5491V	Panasonic
RV1, RV2	2		Ceramic transient voltage suppressor, 2220_250		B72540T6500S162	TDK
SH-J1, SH-J2, SH-J3	3	1x2	Shunt, 100mil, Gold plated, Black	Shunt	969102-0000-DA	3M
TP1, TP2, TP3, TP4, TP5, TP6, TP7, TP8, TP9, TP10, TP11, TP12, TP13, TP14, TP15, TP16, TP17, TP18, TP19, TP20, TP21, TP22, TP23, TP24, TP25, TP26, TP27, TP28, TP29, TP30, TP31	31		Test Point, Miniature, SMT	Testpoint_Keystone_Minature	5015	Keystone
U1	1		TPS2352x Family, PW0016A	PW0016A	TPS23523PW	Texas Instruments
U2	1		Low-Power Bidirectional I2C Isolators, D0008A	D0008A	ISO1541DR	Texas Instruments
U3	1		High-or Low-Side Measurement, Bi-Directional CURRENT/POWER MONITOR with I2C(TM) Interface, DGS0010A	DGS0010A	INA226AIDGSR	Texas Instruments

**Table 7. Bill of Materials (continued)**

Designator	Qty	Value	Description	Package Reference	Part Number	Manufacturer
C1	0	0.47uF	CAP, CERM, 0.47 $\mu$ F, 250 V, $\pm$ 10%, X7R, 1812	1812	GRM43DR72E474KW01L	Murata
C4	0	0.1uF	CAP, CERM, 0.1 $\mu$ F, 250 V, $\pm$ 10%, X7T, 0805	0805	C2012X7T2E104K125AA	TDK
C6, C7	0	330uF	CAP, AL, 330 $\mu$ F, 100 V, $\pm$ 20%, 0.153 ohm, SMD	SMT Radial K16	EEV-FK2A331M	Panasonic
C10	0	0.068uF	CAP, CERM, 0.068 $\mu$ F, 50 V, $\pm$ 10%, X7R, 0603	0603	GRM188R71H683KA93D	Murata
C12	0	10uF	CAP, CERM, 10 $\mu$ F, 6.3 V, $\pm$ 20%, X5R, 0603	0603	C0603C106M9PACTU	Kemet
C13	0	0.01uF	CAP, CERM, 0.01 $\mu$ F, 250 V, $\pm$ 10%, X7R, 0805	0805	QMK212B7103KG-T	Taiyo Yuden
C14	0	0.01uF	CAP, CERM, 0.01 $\mu$ F, 50 V, $\pm$ 5%, X7R, 0603	0603	C0603C103J5RACTU	Kemet
C15	0	0.1uF	CAP, CERM, 0.1uF, 16V, $\pm$ 5%, X7R, 0603	0603	0603YC104JAT2A	AVX
C19	0	0.01uF	CAP, CERM, 0.01 $\mu$ F, 25 V, $\pm$ 10%, X7R, 0603	0603	GRM188R71E103KA01D	Murata
FID1, FID2, FID3, FID4, FID5, FID6	0		Fiducial mark. There is nothing to buy or mount.	Fiducial	N/A	N/A
Q2, Q4	0	200V	MOSFET, N-CH, 200 V, 62 A, DDPAK	DDPAK	IRFS4227PBF	International Rectifier
Q5, Q6, Q10	0	100V	MOSFET, N-CH, 100 V, 17 A, SON 5x6mm	SON 5x6mm	CSD19532Q5B	Texas Instruments
Q9, Q12	0	200V	MOSFET, N-CH, 200 V, 36 A, PG-TDSON-8	PG-TDSON-8	BSC320N20NS3GATMA1	Infineon Technologies
R2	0	10.0	RES, 10.0, 1%, 0.25 W, 1206	1206	RC1206FR-0710RL	Yageo America
R9	0	0	RES, 0, 5%, 0.1 W, 0603	0603	ERJ-3GEY0R00V	Panasonic
R12	0	100	RES, 100, 1%, 0.1 W, 0603	0603	CRCW0603100RFKEA	Vishay-Dale
R15, R18, R19, R22, R24, R26, R30	0	10.0	RES, 10.0 ohm, 1%, 0.1W, 0603	0603	CRCW060310R0FKEA	Vishay-Dale
R29	0	499	RES, 499, 1%, 0.1 W, 0603	0603	RC0603FR-07499RL	Yageo America

## STANDARD TERMS FOR EVALUATION MODULES

1. *Delivery:* TI delivers TI evaluation boards, kits, or modules, including any accompanying demonstration software, components, and/or documentation which may be provided together or separately (collectively, an "EVM" or "EVMs") to the User ("User") in accordance with the terms set forth herein. User's acceptance of the EVM is expressly subject to the following terms.
  - 1.1 EVMs are intended solely for product or software developers for use in a research and development setting to facilitate feasibility evaluation, experimentation, or scientific analysis of TI semiconductor products. EVMs have no direct function and are not finished products. EVMs shall not be directly or indirectly assembled as a part or subassembly in any finished product. For clarification, any software or software tools provided with the EVM ("Software") shall not be subject to the terms and conditions set forth herein but rather shall be subject to the applicable terms that accompany such Software
  - 1.2 EVMs are not intended for consumer or household use. EVMs may not be sold, sublicensed, leased, rented, loaned, assigned, or otherwise distributed for commercial purposes by Users, in whole or in part, or used in any finished product or production system.
2. *Limited Warranty and Related Remedies/Disclaimers:*
  - 2.1 These terms do not apply to Software. The warranty, if any, for Software is covered in the applicable Software License Agreement.
  - 2.2 TI warrants that the TI EVM will conform to TI's published specifications for ninety (90) days after the date TI delivers such EVM to User. Notwithstanding the foregoing, TI shall not be liable for a nonconforming EVM if (a) the nonconformity was caused by neglect, misuse or mistreatment by an entity other than TI, including improper installation or testing, or for any EVMs that have been altered or modified in any way by an entity other than TI, (b) the nonconformity resulted from User's design, specifications or instructions for such EVMs or improper system design, or (c) User has not paid on time. Testing and other quality control techniques are used to the extent TI deems necessary. TI does not test all parameters of each EVM. User's claims against TI under this Section 2 are void if User fails to notify TI of any apparent defects in the EVMs within ten (10) business days after delivery, or of any hidden defects with ten (10) business days after the defect has been detected.
  - 2.3 TI's sole liability shall be at its option to repair or replace EVMs that fail to conform to the warranty set forth above, or credit User's account for such EVM. TI's liability under this warranty shall be limited to EVMs that are returned during the warranty period to the address designated by TI and that are determined by TI not to conform to such warranty. If TI elects to repair or replace such EVM, TI shall have a reasonable time to repair such EVM or provide replacements. Repaired EVMs shall be warranted for the remainder of the original warranty period. Replaced EVMs shall be warranted for a new full ninety (90) day warranty period.
3. *Regulatory Notices:*
  - 3.1 *United States*
    - 3.1.1 *Notice applicable to EVMs not FCC-Approved:*

**FCC NOTICE:** This kit is designed to allow product developers to evaluate electronic components, circuitry, or software associated with the kit to determine whether to incorporate such items in a finished product and software developers to write software applications for use with the end product. This kit is not a finished product and when assembled may not be resold or otherwise marketed unless all required FCC equipment authorizations are first obtained. Operation is subject to the condition that this product not cause harmful interference to licensed radio stations and that this product accept harmful interference. Unless the assembled kit is designed to operate under part 15, part 18 or part 95 of this chapter, the operator of the kit must operate under the authority of an FCC license holder or must secure an experimental authorization under part 5 of this chapter.
    - 3.1.2 *For EVMs annotated as FCC – FEDERAL COMMUNICATIONS COMMISSION Part 15 Compliant:*

### CAUTION

This device complies with part 15 of the FCC Rules. Operation is subject to the following two conditions: (1) This device may not cause harmful interference, and (2) this device must accept any interference received, including interference that may cause undesired operation.

Changes or modifications not expressly approved by the party responsible for compliance could void the user's authority to operate the equipment.

### FCC Interference Statement for Class A EVM devices

*NOTE: This equipment has been tested and found to comply with the limits for a Class A digital device, pursuant to part 15 of the FCC Rules. These limits are designed to provide reasonable protection against harmful interference when the equipment is operated in a commercial environment. This equipment generates, uses, and can radiate radio frequency energy and, if not installed and used in accordance with the instruction manual, may cause harmful interference to radio communications. Operation of this equipment in a residential area is likely to cause harmful interference in which case the user will be required to correct the interference at his own expense.*

## FCC Interference Statement for Class B EVM devices

*NOTE: This equipment has been tested and found to comply with the limits for a Class B digital device, pursuant to part 15 of the FCC Rules. These limits are designed to provide reasonable protection against harmful interference in a residential installation. This equipment generates, uses and can radiate radio frequency energy and, if not installed and used in accordance with the instructions, may cause harmful interference to radio communications. However, there is no guarantee that interference will not occur in a particular installation. If this equipment does cause harmful interference to radio or television reception, which can be determined by turning the equipment off and on, the user is encouraged to try to correct the interference by one or more of the following measures:*

- Reorient or relocate the receiving antenna.
- Increase the separation between the equipment and receiver.
- Connect the equipment into an outlet on a circuit different from that to which the receiver is connected.
- Consult the dealer or an experienced radio/TV technician for help.

### 3.2 Canada

3.2.1 For EVMs issued with an Industry Canada Certificate of Conformance to RSS-210 or RSS-247

#### Concerning EVMs Including Radio Transmitters:

This device complies with Industry Canada license-exempt RSSs. Operation is subject to the following two conditions:

(1) this device may not cause interference, and (2) this device must accept any interference, including interference that may cause undesired operation of the device.

#### Concernant les EVMs avec appareils radio:

Le présent appareil est conforme aux CNR d'Industrie Canada applicables aux appareils radio exempts de licence. L'exploitation est autorisée aux deux conditions suivantes: (1) l'appareil ne doit pas produire de brouillage, et (2) l'utilisateur de l'appareil doit accepter tout brouillage radioélectrique subi, même si le brouillage est susceptible d'en compromettre le fonctionnement.

#### Concerning EVMs Including Detachable Antennas:

Under Industry Canada regulations, this radio transmitter may only operate using an antenna of a type and maximum (or lesser) gain approved for the transmitter by Industry Canada. To reduce potential radio interference to other users, the antenna type and its gain should be so chosen that the equivalent isotropically radiated power (e.i.r.p.) is not more than that necessary for successful communication. This radio transmitter has been approved by Industry Canada to operate with the antenna types listed in the user guide with the maximum permissible gain and required antenna impedance for each antenna type indicated. Antenna types not included in this list, having a gain greater than the maximum gain indicated for that type, are strictly prohibited for use with this device.

#### Concernant les EVMs avec antennes détachables

Conformément à la réglementation d'Industrie Canada, le présent émetteur radio peut fonctionner avec une antenne d'un type et d'un gain maximal (ou inférieur) approuvé pour l'émetteur par Industrie Canada. Dans le but de réduire les risques de brouillage radioélectrique à l'intention des autres utilisateurs, il faut choisir le type d'antenne et son gain de sorte que la puissance isotrope rayonnée équivalente (p.i.r.e.) ne dépasse pas l'intensité nécessaire à l'établissement d'une communication satisfaisante. Le présent émetteur radio a été approuvé par Industrie Canada pour fonctionner avec les types d'antenne énumérés dans le manuel d'usage et ayant un gain admissible maximal et l'impédance requise pour chaque type d'antenne. Les types d'antenne non inclus dans cette liste, ou dont le gain est supérieur au gain maximal indiqué, sont strictement interdits pour l'exploitation de l'émetteur.

### 3.3 Japan

3.3.1 *Notice for EVMs delivered in Japan:* Please see [http://www.tij.co.jp/lstds/ti\\_ja/general/eStore/notice\\_01.page](http://www.tij.co.jp/lstds/ti_ja/general/eStore/notice_01.page) 日本国内に輸入される評価用キット、ボードについては、次のところをご覧ください。  
[http://www.tij.co.jp/lstds/ti\\_ja/general/eStore/notice\\_01.page](http://www.tij.co.jp/lstds/ti_ja/general/eStore/notice_01.page)

3.3.2 *Notice for Users of EVMs Considered "Radio Frequency Products" in Japan:* EVMs entering Japan may not be certified by TI as conforming to Technical Regulations of Radio Law of Japan.

If User uses EVMs in Japan, not certified to Technical Regulations of Radio Law of Japan, User is required to follow the instructions set forth by Radio Law of Japan, which includes, but is not limited to, the instructions below with respect to EVMs (which for the avoidance of doubt are stated strictly for convenience and should be verified by User):

1. Use EVMs in a shielded room or any other test facility as defined in the notification #173 issued by Ministry of Internal Affairs and Communications on March 28, 2006, based on Sub-section 1.1 of Article 6 of the Ministry's Rule for Enforcement of Radio Law of Japan,
2. Use EVMs only after User obtains the license of Test Radio Station as provided in Radio Law of Japan with respect to EVMs, or
3. Use of EVMs only after User obtains the Technical Regulations Conformity Certification as provided in Radio Law of Japan with respect to EVMs. Also, do not transfer EVMs, unless User gives the same notice above to the transferee. Please note that if User does not follow the instructions above, User will be subject to penalties of Radio Law of Japan.

【無線電波を送信する製品の開発キットをお使いになる際の注意事項】 開発キットの中には技術基準適合証明を受けていないものがあります。技術適合証明を受けていないものご使用に際しては、電波法遵守のため、以下のいずれかの措置を取っていただく必要がありますのでご注意ください。

1. 電波法施行規則第6条第1項第1号に基づく平成18年3月28日総務省告示第173号で定められた電波暗室等の試験設備でご使用いただく。
2. 実験局の免許を取得後ご使用いただく。
3. 技術基準適合証明を取得後ご使用いただく。

なお、本製品は、上記の「ご使用にあたっての注意」を譲渡先、移転先に通知しない限り、譲渡、移転できないものとします。

上記を遵守頂けない場合は、電波法の罰則が適用される可能性があることをご留意ください。日本テキサス・インスツルメンツ株式会社

東京都新宿区西新宿 6 丁目 2 4 番 1 号  
西新宿三井ビル

3.3.3 *Notice for EVMs for Power Line Communication:* Please see [http://www.tij.co.jp/lstds/ti\\_ja/general/eStore/notice\\_02.page](http://www.tij.co.jp/lstds/ti_ja/general/eStore/notice_02.page)  
電力線搬送波通信についての開発キットをお使いになる際の注意事項については、次のところをご覧ください。 [http://www.tij.co.jp/lstds/ti\\_ja/general/eStore/notice\\_02.page](http://www.tij.co.jp/lstds/ti_ja/general/eStore/notice_02.page)

#### 3.4 *European Union*

##### 3.4.1 *For EVMs subject to EU Directive 2014/30/EU (Electromagnetic Compatibility Directive):*

This is a class A product intended for use in environments other than domestic environments that are connected to a low-voltage power-supply network that supplies buildings used for domestic purposes. In a domestic environment this product may cause radio interference in which case the user may be required to take adequate measures.

#### 4 *EVM Use Restrictions and Warnings:*

4.1 EVMS ARE NOT FOR USE IN FUNCTIONAL SAFETY AND/OR SAFETY CRITICAL EVALUATIONS, INCLUDING BUT NOT LIMITED TO EVALUATIONS OF LIFE SUPPORT APPLICATIONS.

4.2 User must read and apply the user guide and other available documentation provided by TI regarding the EVM prior to handling or using the EVM, including without limitation any warning or restriction notices. The notices contain important safety information related to, for example, temperatures and voltages.

##### 4.3 *Safety-Related Warnings and Restrictions:*

4.3.1 User shall operate the EVM within TI's recommended specifications and environmental considerations stated in the user guide, other available documentation provided by TI, and any other applicable requirements and employ reasonable and customary safeguards. Exceeding the specified performance ratings and specifications (including but not limited to input and output voltage, current, power, and environmental ranges) for the EVM may cause personal injury or death, or property damage. If there are questions concerning performance ratings and specifications, User should contact a TI field representative prior to connecting interface electronics including input power and intended loads. Any loads applied outside of the specified output range may also result in unintended and/or inaccurate operation and/or possible permanent damage to the EVM and/or interface electronics. Please consult the EVM user guide prior to connecting any load to the EVM output. If there is uncertainty as to the load specification, please contact a TI field representative. During normal operation, even with the inputs and outputs kept within the specified allowable ranges, some circuit components may have elevated case temperatures. These components include but are not limited to linear regulators, switching transistors, pass transistors, current sense resistors, and heat sinks, which can be identified using the information in the associated documentation. When working with the EVM, please be aware that the EVM may become very warm.

4.3.2 EVMs are intended solely for use by technically qualified, professional electronics experts who are familiar with the dangers and application risks associated with handling electrical mechanical components, systems, and subsystems. User assumes all responsibility and liability for proper and safe handling and use of the EVM by User or its employees, affiliates, contractors or designees. User assumes all responsibility and liability to ensure that any interfaces (electronic and/or mechanical) between the EVM and any human body are designed with suitable isolation and means to safely limit accessible leakage currents to minimize the risk of electrical shock hazard. User assumes all responsibility and liability for any improper or unsafe handling or use of the EVM by User or its employees, affiliates, contractors or designees.

4.4 User assumes all responsibility and liability to determine whether the EVM is subject to any applicable international, federal, state, or local laws and regulations related to User's handling and use of the EVM and, if applicable, User assumes all responsibility and liability for compliance in all respects with such laws and regulations. User assumes all responsibility and liability for proper disposal and recycling of the EVM consistent with all applicable international, federal, state, and local requirements.

5. *Accuracy of Information:* To the extent TI provides information on the availability and function of EVMs, TI attempts to be as accurate as possible. However, TI does not warrant the accuracy of EVM descriptions, EVM availability or other information on its websites as accurate, complete, reliable, current, or error-free.

6. *Disclaimers:*

6.1 EXCEPT AS SET FORTH ABOVE, EVMS AND ANY MATERIALS PROVIDED WITH THE EVM (INCLUDING, BUT NOT LIMITED TO, REFERENCE DESIGNS AND THE DESIGN OF THE EVM ITSELF) ARE PROVIDED "AS IS" AND "WITH ALL FAULTS." TI DISCLAIMS ALL OTHER WARRANTIES, EXPRESS OR IMPLIED, REGARDING SUCH ITEMS, INCLUDING BUT NOT LIMITED TO ANY EPIDEMIC FAILURE WARRANTY OR IMPLIED WARRANTIES OF MERCHANTABILITY OR FITNESS FOR A PARTICULAR PURPOSE OR NON-INFRINGEMENT OF ANY THIRD PARTY PATENTS, COPYRIGHTS, TRADE SECRETS OR OTHER INTELLECTUAL PROPERTY RIGHTS.

6.2 EXCEPT FOR THE LIMITED RIGHT TO USE THE EVM SET FORTH HEREIN, NOTHING IN THESE TERMS SHALL BE CONSTRUED AS GRANTING OR CONFERRING ANY RIGHTS BY LICENSE, PATENT, OR ANY OTHER INDUSTRIAL OR INTELLECTUAL PROPERTY RIGHT OF TI, ITS SUPPLIERS/LICENSORS OR ANY OTHER THIRD PARTY, TO USE THE EVM IN ANY FINISHED END-USER OR READY-TO-USE FINAL PRODUCT, OR FOR ANY INVENTION, DISCOVERY OR IMPROVEMENT, REGARDLESS OF WHEN MADE, CONCEIVED OR ACQUIRED.

7. *USER'S INDEMNITY OBLIGATIONS AND REPRESENTATIONS.* USER WILL DEFEND, INDEMNIFY AND HOLD TI, ITS LICENSORS AND THEIR REPRESENTATIVES HARMLESS FROM AND AGAINST ANY AND ALL CLAIMS, DAMAGES, LOSSES, EXPENSES, COSTS AND LIABILITIES (COLLECTIVELY, "CLAIMS") ARISING OUT OF OR IN CONNECTION WITH ANY HANDLING OR USE OF THE EVM THAT IS NOT IN ACCORDANCE WITH THESE TERMS. THIS OBLIGATION SHALL APPLY WHETHER CLAIMS ARISE UNDER STATUTE, REGULATION, OR THE LAW OF TORT, CONTRACT OR ANY OTHER LEGAL THEORY, AND EVEN IF THE EVM FAILS TO PERFORM AS DESCRIBED OR EXPECTED.

8. *Limitations on Damages and Liability:*

8.1 *General Limitations.* IN NO EVENT SHALL TI BE LIABLE FOR ANY SPECIAL, COLLATERAL, INDIRECT, PUNITIVE, INCIDENTAL, CONSEQUENTIAL, OR EXEMPLARY DAMAGES IN CONNECTION WITH OR ARISING OUT OF THESE TERMS OR THE USE OF THE EVMS, REGARDLESS OF WHETHER TI HAS BEEN ADVISED OF THE POSSIBILITY OF SUCH DAMAGES. EXCLUDED DAMAGES INCLUDE, BUT ARE NOT LIMITED TO, COST OF REMOVAL OR REINSTALLATION, ANCILLARY COSTS TO THE PROCUREMENT OF SUBSTITUTE GOODS OR SERVICES, RETESTING, OUTSIDE COMPUTER TIME, LABOR COSTS, LOSS OF GOODWILL, LOSS OF PROFITS, LOSS OF SAVINGS, LOSS OF USE, LOSS OF DATA, OR BUSINESS INTERRUPTION. NO CLAIM, SUIT OR ACTION SHALL BE BROUGHT AGAINST TI MORE THAN TWELVE (12) MONTHS AFTER THE EVENT THAT GAVE RISE TO THE CAUSE OF ACTION HAS OCCURRED.

8.2 *Specific Limitations.* IN NO EVENT SHALL TI'S AGGREGATE LIABILITY FROM ANY USE OF AN EVM PROVIDED HEREUNDER, INCLUDING FROM ANY WARRANTY, INDEMNITY OR OTHER OBLIGATION ARISING OUT OF OR IN CONNECTION WITH THESE TERMS, EXCEED THE TOTAL AMOUNT PAID TO TI BY USER FOR THE PARTICULAR EVM(S) AT ISSUE DURING THE PRIOR TWELVE (12) MONTHS WITH RESPECT TO WHICH LOSSES OR DAMAGES ARE CLAIMED. THE EXISTENCE OF MORE THAN ONE CLAIM SHALL NOT ENLARGE OR EXTEND THIS LIMIT.

9. *Return Policy.* Except as otherwise provided, TI does not offer any refunds, returns, or exchanges. Furthermore, no return of EVM(s) will be accepted if the package has been opened and no return of the EVM(s) will be accepted if they are damaged or otherwise not in a resalable condition. If User feels it has been incorrectly charged for the EVM(s) it ordered or that delivery violates the applicable order, User should contact TI. All refunds will be made in full within thirty (30) working days from the return of the components(s), excluding any postage or packaging costs.

10. *Governing Law:* These terms and conditions shall be governed by and interpreted in accordance with the laws of the State of Texas, without reference to conflict-of-laws principles. User agrees that non-exclusive jurisdiction for any dispute arising out of or relating to these terms and conditions lies within courts located in the State of Texas and consents to venue in Dallas County, Texas. Notwithstanding the foregoing, any judgment may be enforced in any United States or foreign court, and TI may seek injunctive relief in any United States or foreign court.

## IMPORTANT NOTICE FOR TI DESIGN INFORMATION AND RESOURCES

Texas Instruments Incorporated ("TI") technical, application or other design advice, services or information, including, but not limited to, reference designs and materials relating to evaluation modules, (collectively, "TI Resources") are intended to assist designers who are developing applications that incorporate TI products; by downloading, accessing or using any particular TI Resource in any way, you (individually or, if you are acting on behalf of a company, your company) agree to use it solely for this purpose and subject to the terms of this Notice.

TI's provision of TI Resources does not expand or otherwise alter TI's applicable published warranties or warranty disclaimers for TI products, and no additional obligations or liabilities arise from TI providing such TI Resources. TI reserves the right to make corrections, enhancements, improvements and other changes to its TI Resources.

You understand and agree that you remain responsible for using your independent analysis, evaluation and judgment in designing your applications and that you have full and exclusive responsibility to assure the safety of your applications and compliance of your applications (and of all TI products used in or for your applications) with all applicable regulations, laws and other applicable requirements. You represent that, with respect to your applications, you have all the necessary expertise to create and implement safeguards that (1) anticipate dangerous consequences of failures, (2) monitor failures and their consequences, and (3) lessen the likelihood of failures that might cause harm and take appropriate actions. You agree that prior to using or distributing any applications that include TI products, you will thoroughly test such applications and the functionality of such TI products as used in such applications. TI has not conducted any testing other than that specifically described in the published documentation for a particular TI Resource.

You are authorized to use, copy and modify any individual TI Resource only in connection with the development of applications that include the TI product(s) identified in such TI Resource. NO OTHER LICENSE, EXPRESS OR IMPLIED, BY ESTOPPEL OR OTHERWISE TO ANY OTHER TI INTELLECTUAL PROPERTY RIGHT, AND NO LICENSE TO ANY TECHNOLOGY OR INTELLECTUAL PROPERTY RIGHT OF TI OR ANY THIRD PARTY IS GRANTED HEREIN, including but not limited to any patent right, copyright, mask work right, or other intellectual property right relating to any combination, machine, or process in which TI products or services are used. Information regarding or referencing third-party products or services does not constitute a license to use such products or services, or a warranty or endorsement thereof. Use of TI Resources may require a license from a third party under the patents or other intellectual property of the third party, or a license from TI under the patents or other intellectual property of TI.

TI RESOURCES ARE PROVIDED "AS IS" AND WITH ALL FAULTS. TI DISCLAIMS ALL OTHER WARRANTIES OR REPRESENTATIONS, EXPRESS OR IMPLIED, REGARDING TI RESOURCES OR USE THEREOF, INCLUDING BUT NOT LIMITED TO ACCURACY OR COMPLETENESS, TITLE, ANY EPIDEMIC FAILURE WARRANTY AND ANY IMPLIED WARRANTIES OF MERCHANTABILITY, FITNESS FOR A PARTICULAR PURPOSE, AND NON-INFRINGEMENT OF ANY THIRD PARTY INTELLECTUAL PROPERTY RIGHTS.

TI SHALL NOT BE LIABLE FOR AND SHALL NOT DEFEND OR INDEMNIFY YOU AGAINST ANY CLAIM, INCLUDING BUT NOT LIMITED TO ANY INFRINGEMENT CLAIM THAT RELATES TO OR IS BASED ON ANY COMBINATION OF PRODUCTS EVEN IF DESCRIBED IN TI RESOURCES OR OTHERWISE. IN NO EVENT SHALL TI BE LIABLE FOR ANY ACTUAL, DIRECT, SPECIAL, COLLATERAL, INDIRECT, PUNITIVE, INCIDENTAL, CONSEQUENTIAL OR EXEMPLARY DAMAGES IN CONNECTION WITH OR ARISING OUT OF TI RESOURCES OR USE THEREOF, AND REGARDLESS OF WHETHER TI HAS BEEN ADVISED OF THE POSSIBILITY OF SUCH DAMAGES.

You agree to fully indemnify TI and its representatives against any damages, costs, losses, and/or liabilities arising out of your non-compliance with the terms and provisions of this Notice.

This Notice applies to TI Resources. Additional terms apply to the use and purchase of certain types of materials, TI products and services. These include; without limitation, TI's standard terms for semiconductor products (<http://www.ti.com/sc/docs/stdterms.htm>), [evaluation modules](#), and [samples](http://www.ti.com/sc/docs/sampterm.htm) (<http://www.ti.com/sc/docs/sampterm.htm>).

Mailing Address: Texas Instruments, Post Office Box 655303, Dallas, Texas 75265  
Copyright © 2017, Texas Instruments Incorporated