

LM2773 Low-Ripple 1.8V/1.6V Spread-Spectrum Switched Capacitor Step-Down Regulator

Check for Samples: [LM2773](#)

FEATURES

- Low-Noise Spread Spectrum Operation
- 1.8V/1.6V Selectable Output Voltage
- 2% Output Voltage Regulation
- > 75% Efficiency in 1.8V Mode
- Very Low Output Ripple: 10mV @ 300mA
- Output Currents up to 300mA
- 2.5V to 5.5V Input Voltage Range
- Shutdown Disconnects Load from V_{IN}
- 1.15MHz Switching Frequency
- No Inductors...Small Solution Size
- Short Circuit and Thermal Protection
- 0.5mm pitch, DSBGA-9 (1.511 × 1.511mm × 0.6mm)

APPLICATIONS

- Power Supply for DSP's, Memory, and Microprocessors
- Mobile Phones and Pagers
- Digital Cameras, Portable Music Players, and Other Portable Electronic Devices

Typical Application Circuit

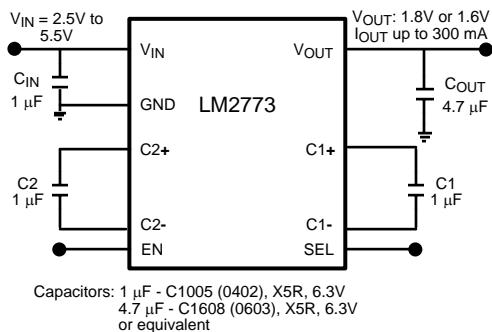
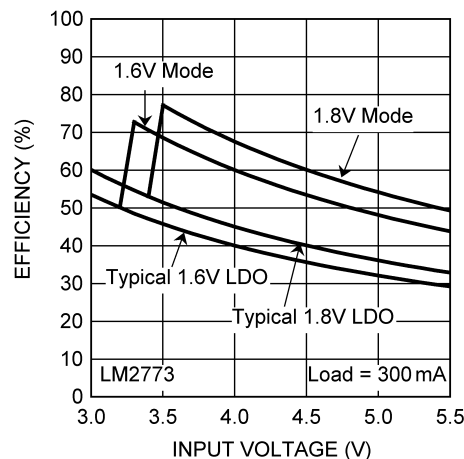

Figure 1.

DESCRIPTION

The LM2773 is a switched capacitor step-down regulator that produces a selectable 1.8V or 1.6V output. It is capable of supplying loads up to 300mA. The LM2773 operates with an input voltage from 2.5V to 5.5V, accommodating 1-cell Li-Ion batteries and chargers.

The LM2773 utilizes a regulated charge pump with gains of 2/3x and 1x. It has very low ripple and noise on both the input and output due to its pre-regulated 1.15MHz (typ.) switching frequency and spread spectrum operation. When output currents are low, the LM2773 automatically switches to a low-ripple PFM regulation mode to maintain high efficiency over the entire load range.

The LM2773 is available in TI's 0.5mm pitch 9-bump DSBGA.

Figure 2. LM2773 Efficiency vs. Low-Dropout Linear Regulator (LDO) Efficiency

Please be aware that an important notice concerning availability, standard warranty, and use in critical applications of Texas Instruments semiconductor products and disclaimers thereto appears at the end of this data sheet.

All trademarks are the property of their respective owners.

Connection Diagram

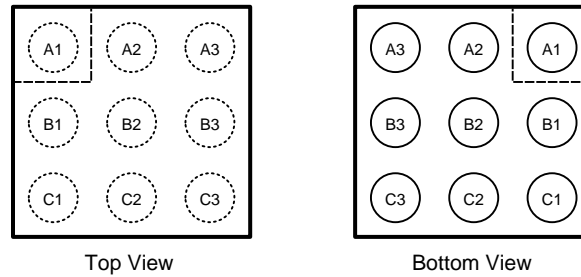

9-Bump DSBGA
See Package Number YZR0009
0.5mm Pitch 1.511mm x 1.511mm x 0.6mm

PIN DESCRIPTIONS

Pin #	Name	Description
A1	C2-	Flying Capacitor 2: Negative Terminal
A2	V _{OUT}	Output Voltage
A3	C1+	Flying Capacitor 1: Positive Terminal
B1	GND	Ground
B2	EN	Device Enable. Logic HIGH: Enabled, Logic LOW: Shutdown.
B3	V _{IN}	Input Voltage. Recommended V _{IN} Operating Range = 2.5V to 5.5V.
C1	SEL	Voltage Mode Select. Logic HIGH: V _{OUT} = 1.6V, Logic LOW: V _{OUT} = 1.8V
C2	C1-	Flying Capacitor 1: Negative Terminal
C3	C2+	Flying Capacitor 2: Positive Terminal



These devices have limited built-in ESD protection. The leads should be shorted together or the device placed in conductive foam during storage or handling to prevent electrostatic damage to the MOS gates.

Absolute Maximum Ratings⁽¹⁾⁽²⁾⁽³⁾

V _{IN} Pin Voltage	-0.3V to 6.0V
EN, SEL Pin Voltage	-0.3V to (V _{IN} +0.3V) w/ 6.0V max
Continuous Power Dissipation ⁽⁴⁾	Internally Limited
Junction Temperature (T _{J-MAX})	150°C
Storage Temperature Range	-65°C to +150° C
Maximum Lead Temperature (Soldering, 10 sec.)	265°C
ESD Rating ⁽⁵⁾ Human Body Model:	2.5kV

- (1) Absolute Maximum Ratings indicate limits beyond which damage to the component may occur. Operating Ratings are conditions under which operation of the device is ensured. Operating Ratings do not imply specified performance limits. For specified performance limits and associated test conditions, see the Electrical Characteristics tables.
- (2) If Military/Aerospace specified devices are required, please contact the TI Sales Office/Distributors for availability and specifications.
- (3) All voltages are with respect to the potential at the GND pins.
- (4) Internal thermal shutdown circuitry protects the device from permanent damage. Thermal shutdown engages at T_J=150°C (typ.) and disengages at T_J=140°C (typ.).
- (5) The Human body model is a 100pF capacitor discharged through a 1.5kΩ resistor into each pin. MIL-STD-883 3015.7

Operating Ratings⁽¹⁾⁽²⁾

Input Voltage Range	2.5V to 5.5V
Recommended Load Current Range	0mA to 300mA
Junction Temperature (T _J) Range	-30°C to +110°C
Ambient Temperature (T _A) Range ⁽³⁾	-30°C to +85°C

- (1) Absolute Maximum Ratings indicate limits beyond which damage to the component may occur. Operating Ratings are conditions under which operation of the device is ensured. Operating Ratings do not imply ensured performance limits. For specified performance limits and associated test conditions, see the Electrical Characteristics tables.
- (2) All voltages are with respect to the potential at the GND pins.
- (3) Maximum ambient temperature (T_{A-MAX}) is dependent on the maximum operating junction temperature (T_{J-MAX-OP} = 110°C), the maximum power dissipation of the device in the application (P_{D-MAX}), and the junction-to ambient thermal resistance of the part/package in the application (θ_{JA}), as given by the following equation: T_{A-MAX} = T_{J-MAX-OP} – (θ_{JA} × P_{D-MAX}).

Thermal Properties

Junction-to-Ambient Thermal Resistance (θ _{JA}), DSBGA-9 Package ⁽¹⁾	75°C/W
---	--------

- (1) Junction-to-ambient thermal resistance is highly application and board-layout dependent. In applications where high maximum power dissipation exists, special care must be paid to thermal dissipation issues.

Electrical Characteristics⁽¹⁾⁽²⁾

Limits in standard typeface are for $T_J = 25^\circ\text{C}$. Limits in **boldface** type apply over the full operating junction temperature range ($-30^\circ\text{C} \leq T_J \leq +110^\circ\text{C}$). Unless otherwise noted, specifications apply to the LM2773 Typical Application Circuit (pg. 1) with: $V_{IN} = 3.6\text{V}$; $V(\text{EN}) = 1.8\text{V}$, $V(\text{SEL}) = 0\text{V}$, $C_{IN} = C_1 = C_2 = 1.0\mu\text{F}$, $C_{OUT} = 4.7\mu\text{F}$.⁽³⁾

Symbol	Parameter	Condition	Min	Typ	Max	Units
V_{OUT}	1.8V Mode Output Voltage Regulation	$2.5\text{V} \leq V_{IN} \leq 5.5\text{V}$ $0\text{mA} \leq I_{OUT} \leq 300\text{mA}$	1.779 (-2%)	1.815	1.851 (+2%)	V
	1.6V Mode Output Voltage Regulation	$V(\text{SEL}) = 1.8\text{V}$ $2.5\text{V} \leq V_{IN} \leq 5.5\text{V}$ $0\text{mA} \leq I_{OUT} \leq 300\text{mA}$	1.587 (-2%)	1.619	1.651 (+2%)	
V_{OUT}/I_{OUT}	Output Load Regulation	$0\text{mA} \leq I_{OUT} \leq 300\text{mA}$		0.15		mV/mA
V_{OUT}/V_{IN}	Output Line Regulation			0.3		%/V
E	Power Efficiency	$I_{OUT} = 300\text{mA}$		75		%
I_Q	Quiescent Supply Current	$I_{OUT} = 0\text{mA}$ See ⁽⁴⁾		48	55	μA
V_R	Fixed Frequency Output Ripple	$I_{OUT} = 300\text{mA}$		10		mV
V_{R-PFM}	PFM-Mode Output Ripple	$I_{OUT} < 40\text{mA}$		12		mV
I_{SD}	Shutdown Current	$V(\text{EN}) = 0\text{V}$		0.1	0.625	μA
F_{SW}	Switching Frequency	$3.0\text{V} \leq V_{IN} \leq 5.5\text{V}$	0.80	1.15	1.50	MHz
R_{OL}	Open-Loop Output Resistance	$I_{OUT} = 300\text{mA}$ See ⁽⁵⁾		1.0		Ω
I_{CL}	Output Current Limit	$V_{IN} = 5.5\text{V}$ $0\text{V} \leq V_{OUT} \leq 0.2\text{V}$ See ⁽⁶⁾		500		mA
t_{ON}	Turn-on Time			150		μs
V_{IL}	Logic-low Input Voltage	EN, SEL Pins $2.5\text{V} \leq V_{IN} \leq 5.5\text{V}$	0		0.5	V
V_{IH}	Logic-high Input Voltage	EN, SEL Pins $2.5\text{V} \leq V_{IN} \leq 5.5\text{V}$	1.0		V_{IN}	V
I_{IH}	Logic-high Input Current	$V(\text{EN}), V(\text{SEL}) = 1.8\text{V}$ See ⁽⁷⁾		5		μA
I_{IL}	Logic-low Input Current	$V(\text{EN}), V(\text{SEL}) = 0\text{V}$		0.01		μA

(1) All voltages are with respect to the potential at the GND pins.

(2) Min and Max limits are specified by design, test, or statistical analysis. Typical numbers are not ensured, but do represent the most likely norm.

(3) C_{IN} , C_{OUT} , C_1 , C_2 : Low-ESR Surface-Mount Ceramic Capacitors (MLCCs) used in setting electrical characteristics.

(4) V_{OUT} is set to 1.9V during this test (Device is not switching).

(5) Open loop output resistance can be used to predict output voltage when, under low V_{IN} and high I_{OUT} conditions, V_{OUT} falls out of regulation. $V_{OUT} = (\text{Gain})V_{IN} - (R_{OL} \times I_{OUT})$

(6) Under the stated conditions, the maximum input current is equal to 2/3 the maximum output current.

(7) There are 350k Ω pull-down resistors connected internally between the EN pin and GND and the SEL pin and GND.

Typical Performance Characteristics

Unless otherwise specified: $V_{IN} = 3.6V$, $C_{IN} = C_1 = C_2 = 1.0\mu F$, $C_{OUT} = 4.7\mu F$, $V(EN) = 1.8V$, $V(SEL) = 0V$, $T_A = 25^\circ C$.
Capacitors are low-ESR multi-layer ceramic capacitors (MLCC's).

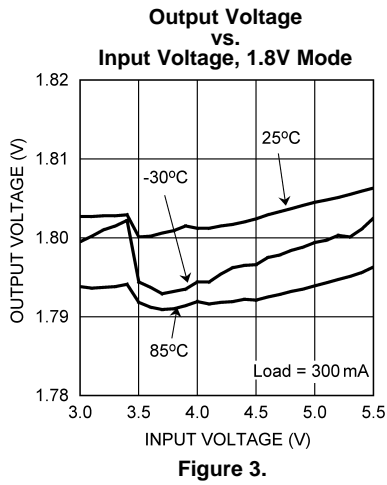

Figure 3.

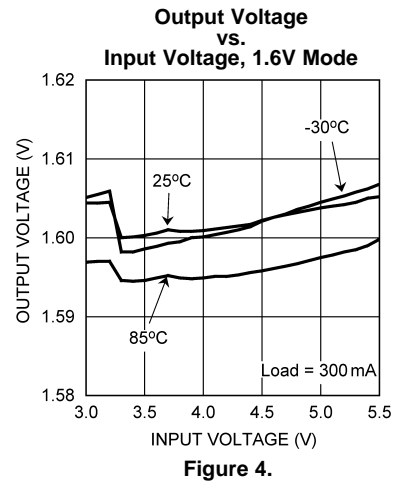

Figure 4.

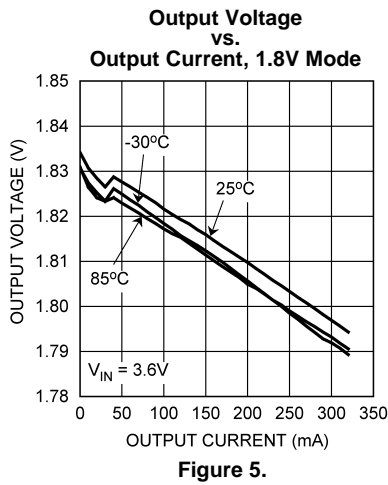

Figure 5.

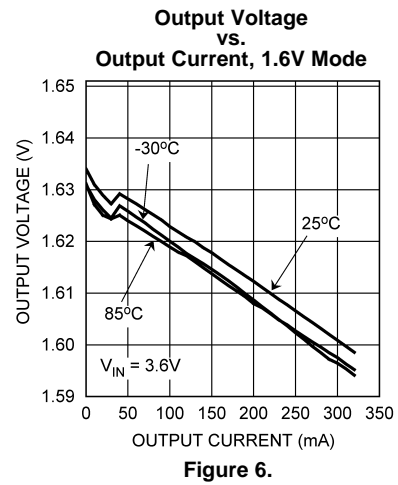

Figure 6.

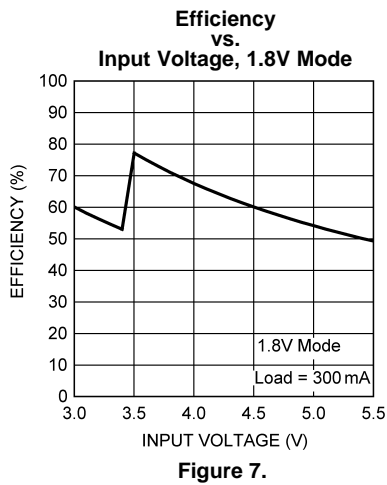

Figure 7.

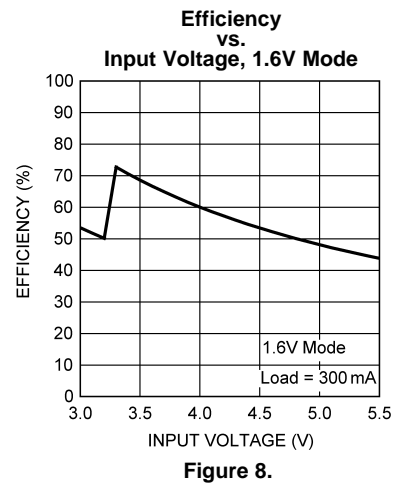

Figure 8.

Typical Performance Characteristics (continued)

Unless otherwise specified: $V_{IN} = 3.6V$, $C_{IN} = C_1 = C_2 = 1.0\mu F$, $C_{OUT} = 4.7\mu F$, $V(EN) = 1.8V$, $V(SEL) = 0V$, $T_A = 25^\circ C$.
Capacitors are low-ESR multi-layer ceramic capacitors (MLCC's).

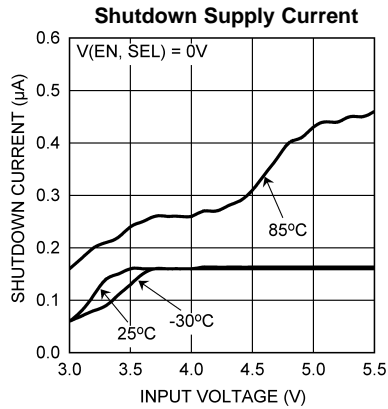

Figure 9.

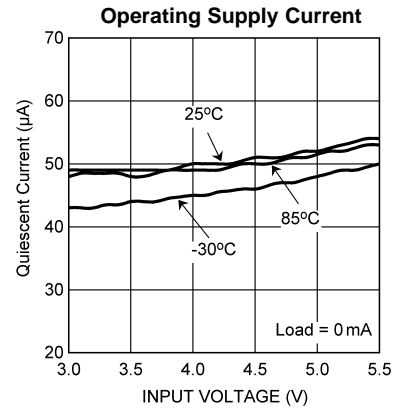
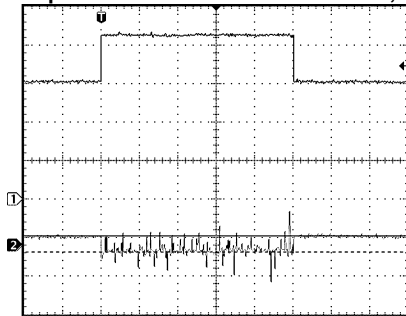

Figure 10.

Line Step 3.0V to 4.2V with Load = 300mA, 1.8V Mode



CH1: V_{IN} ; Scale: 1V/Div, DC Coupled
CH2: V_{OUT} ; Scale: 20mV/Div, AC Coupled
Time scale: 10ms/Div

Figure 11.

Line Step 3.0V to 4.2V with Load = 300mA, 1.6V Mode

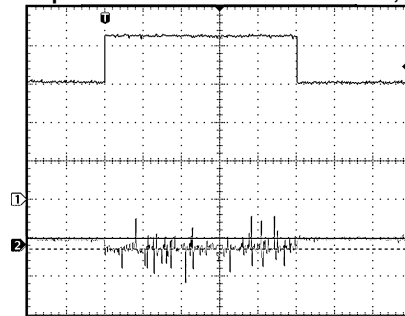

CH1: V_{IN} ; Scale: 1V/Div, DC Coupled
CH2: V_{OUT} ; Scale: 20mV/Div, AC Coupled
Time scale: 10ms/Div

Figure 12.

Load Step 0mA to 300mA, $V_{IN} = 3.6V$, 1.8V Mode

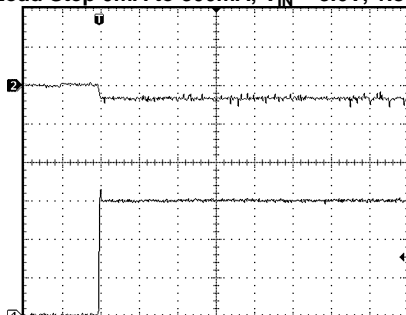

CH2: V_{OUT} ; Scale: 100mV/Div
DC Coupled, Offset 1.834V
CH4: I_{OUT} ; Scale: 100mA/Div
Time scale: 4ms/Div

Figure 13.

Load Step 300mA to 0mA, $V_{IN} = 3.6V$, 1.8V Mode

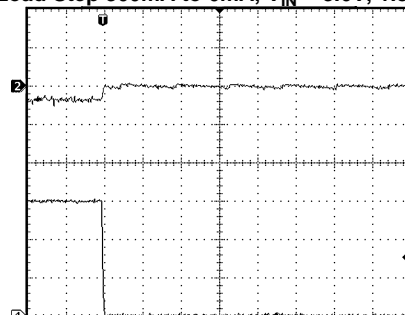

CH2: V_{OUT} ; Scale: 100mV/Div
DC Coupled, Offset 1.834V
CH4: I_{OUT} ; Scale: 100mA/Div
Time scale: 4ms/Div

Figure 14.

Typical Performance Characteristics (continued)

Unless otherwise specified: $V_{IN} = 3.6V$, $C_{IN} = C_1 = C_2 = 1.0\mu F$, $C_{OUT} = 4.7\mu F$, $V(EN) = 1.8V$, $V(SEL) = 0V$, $T_A = 25^\circ C$.
Capacitors are low-ESR multi-layer ceramic capacitors (MLCC's).

Load Step 0mA to 300mA, $V_{IN} = 3.6V$, 1.6V Mode

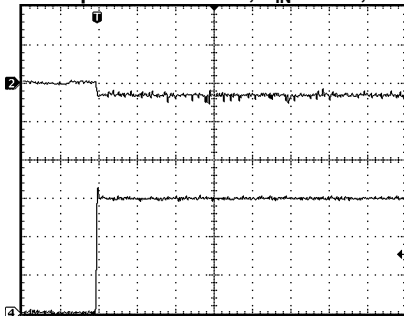

CH2: V_{OUT} ; Scale: 100mV/Div
DC Coupled, Offset 1.633V
CH4: I_{OUT} ; Scale: 100mA/Div
Time scale: 4ms/Div

Figure 15.

Load Step 300mA to 0mA, $V_{IN} = 3.6V$, 1.6V Mode

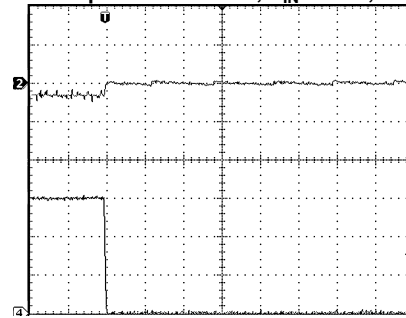

CH2: V_{OUT} ; Scale: 100mV/Div
DC Coupled, Offset 1.633V
CH4: I_{OUT} ; Scale: 100mA/Div
Time scale: 4ms/Div

Figure 16.

1.8V Mode Startup, Load = 300mA

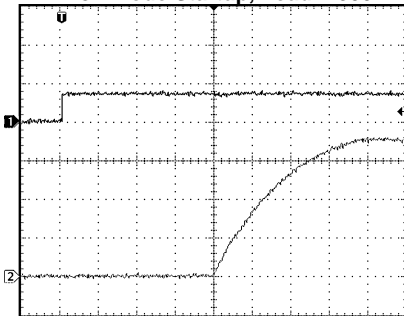

CH1: V_{EN} ; Scale: 5V/Div, DC Coupled
CH2: V_{OUT} ; Scale: 500mV/Div, DC Coupled
Time scale: 10µs/Div

Figure 17.

1.6V Mode Startup, Load = 300mA, $V_{SEL} = V_{IN}$

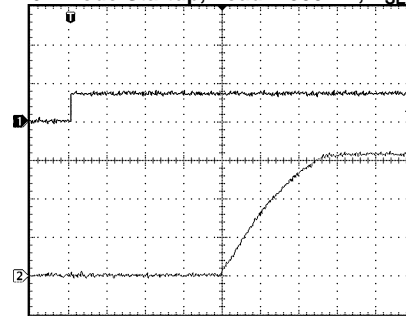

CH1: V_{EN} ; Scale: 5V/Div, DC Coupled
CH2: V_{OUT} ; Scale: 500mV/Div, DC Coupled
Time scale: 10µs/Div

Figure 18.

OPERATION DESCRIPTION

Overview

The LM2773 is a switched capacitor converter that produces a selectable 1.8V or 1.6V regulated output. The core of the part is a highly efficient charge pump that utilizes fixed frequency pre-regulation, Pulse Frequency Modulation, and spread spectrum to minimize conducted noise and power losses over wide input voltage and output current ranges. A description of the principal operational characteristics of the LM2773 is detailed in the [Circuit Description](#), and [Efficiency Performance](#) sections. These sections refer to details in the [Block Diagram](#).

Circuit Description

The core of the LM2773 is a two-phase charge pump controlled by an internally generated non-overlapping clock. The charge pump operates by using external flying capacitors C_1 and C_2 to transfer charge from the input to the output. The LM2773 will operate in a 1x Gain, with the input current being equal to the load current, when the input voltage is at or below 3.5V (typ.) for 1.8V mode or 3.3V (typ.) for 1.6V mode. At input voltages above 3.5V (typ.) or 3.3V (typ.) for the respective voltage mode selected, the part utilizes a gain of 2/3x, resulting in an input current equal to 2/3 times the load current.

The two phases of the switched capacitor switching cycle will be referred to as the "charge phase" and the "discharge phase". During the charge phase, the flying capacitor is charged by the input supply. After half of the switching cycle [$t = 1/(2 \times F_{SW})$], the LM2773 switches to the discharge phase. In this configuration, the charge that was stored on the flying capacitors in the charge phase is transferred to the output.

The LM2773 uses fixed frequency pre-regulation to regulate the output voltage to 1.8V during moderate to high load currents. The input and output connections of the flying capacitors are made with internal MOS switches. Pre-regulation limits the gate drive of the MOS switch connected between the voltage input and the flying capacitors. Controlling the on resistance of this switch limits the amount of charge transferred into and out of each flying capacitor during the charge and discharge phases, and in turn helps to keep the output ripple very low.

When output currents are low (<40mA typ.), the LM2773 automatically switches to a low-ripple Pulse Frequency Modulation (PFM) form of regulation. In PFM mode, the flying capacitors stay in the discharge phase until the output voltage drops below a predetermined trip point. When this occurs, the flying capacitors switch back to the charge phase. After being charged, the flying capacitors repeat the process of staying in the discharge phase and switching to the charge phase when necessary.

The LM2773 utilizes spread spectrum operation to distribute the peak radiated energy of the device over a wider frequency band, reducing electromagnetic interference (EMI). Spread spectrum is used during all modes of operation for the LM2773.

Efficiency Performance

Charge-pump efficiency is derived in the following two ideal equations (supply current and other losses are neglected for simplicity):

$$I_{IN} = G \times I_{OUT} \quad (1)$$

$$E = (V_{OUT} \times I_{OUT}) \div (V_{IN} \times I_{IN}) = V_{OUT} \div (G \times V_{IN}) \quad (2)$$

In the equations, G represents the charge pump gain. Efficiency is at its highest as $G \times V_{IN}$ approaches V_{OUT} . Refer to the efficiency graph in the [Typical Performance Characteristics](#) section for detailed efficiency data. The transition between the gain of 1x and 2/3x is clearly distinguished by the sharp discontinuity in the efficiency curve.

Shutdown and Voltage Select

The LM2773 is in shutdown mode when the voltage on the enable pin (EN) is logic-low. In shutdown, the LM2773 draws virtually no supply current. When in shutdown, the output of the LM2773 is completely disconnected from the input. Internal feedback resistors pull the output voltage down to 0V during shutdown.

The SEL pin sets the output voltage at either 1.8V or 1.6V. A logic-low voltage on the SEL pin will place the output of the LM2773 in the 1.6V mode, and a logic-high voltage on the SEL pin will place it into the 1.8V mode.

There are 350kΩ pull-down resistors connected internally between the EN pin and GND and the SEL pin and GND.

Soft Start

The LM2773 employs soft start circuitry to prevent excessive input inrush currents during startup. At startup, the output voltage gradually rises from 0V to the nominal output voltage. This occurs in 150 μ s (typ.). Soft-start is engaged when the part is enabled.

Thermal Shutdown

Protection from damage related to overheating is achieved with a thermal shutdown feature. When the junction temperature rises to 150°C (typ.), the part switches into shutdown mode. The LM2773 disengages thermal shutdown when the junction temperature of the part is reduced to 140°C (typ.). Due to the high efficiency of the LM2773, thermal shutdown and/or thermal cycling should not be encountered when the part is operated within specified input voltage, output current, and ambient temperature operating ratings. If thermal cycling is seen under these conditions, the most likely cause is an inadequate PCB layout that does not allow heat to be sufficiently dissipated out of the DSBGA package.

Current Limit Protection

The LM2773 charge pump contains current limit protection circuitry that protects the device during V_{OUT} fault conditions where excessive current is drawn. Output current is limited to 500mA (typ.).

APPLICATION INFORMATION

Recommended Capacitor Types

The LM2773 requires 4 external capacitors for proper operation. Surface-mount multi-layer ceramic capacitors are recommended. These capacitors are small, inexpensive and have very low equivalent series resistance (ESR, $\leq 15m\Omega$ typ.). Tantalum capacitors, OS-CON capacitors, and aluminum electrolytic capacitors generally are not recommended for use with the LM2773 due to their high ESR, as compared to ceramic capacitors.

For most applications, ceramic capacitors with an X7R or X5R temperature characteristic are preferred for use with the LM2773. These capacitors have tight capacitance tolerance (as good as $\pm 10\%$) and hold their value over temperature (X7R: $\pm 15\%$ over -55°C to 125°C; X5R: $\pm 15\%$ over -55°C to 85°C).

Capacitors with a Y5V or Z5U temperature characteristic are generally not recommended for use with the LM2773. These types of capacitors typically have wide capacitance tolerance (+80%, -20%) and vary significantly over temperature (Y5V: +22%, -82% over -30°C to +85°C range; Z5U: +22%, -56% over +10°C to +85°C range). Under some conditions, a 1 μ F-rated Y5V or Z5U capacitor could have a capacitance as low as 0.1 μ F. Such detrimental deviation is likely to cause Y5V and Z5U capacitors to fail to meet the minimum capacitance requirements of the LM2773.

Net capacitance of a ceramic capacitor decreases with increased DC bias. This degradation can result in lower capacitance than expected on the input and/or output, resulting in higher ripple voltages and currents. Using capacitors at DC bias voltages significantly below the capacitor voltage rating will usually minimize DC bias effects. Consult capacitor manufacturers for information on capacitor DC bias characteristics.

Capacitance characteristics can vary quite dramatically with different application conditions, capacitor types, and capacitor manufacturers. It is strongly recommended that the LM2773 circuit be thoroughly evaluated early in the design-in process with the mass-production capacitors of choice. This will help ensure that any such variability in capacitance does not negatively impact circuit performance.

The table below lists some leading ceramic capacitor manufacturers.

Manufacturer	Contact Information
AVX	www.avx.com
Murata	www.murata.com
Taiyo-Yuden	www.t-yuden.com
TDK	www.component.tdk.com
Vishay-Vitramon	www.vishay.com

Output Capacitor and Output Voltage Ripple

The output capacitor in the LM2773 circuit (C_{OUT}) directly impacts the magnitude of output voltage ripple. Other prominent factors also affecting output voltage ripple include input voltage, output current and flying capacitance. Due to the complexity of the regulation topology, providing equations or models to approximate the magnitude of the ripple can not be easily accomplished. But one important generalization can be made: increasing (decreasing) the output capacitance will result in a proportional decrease (increase) in output voltage ripple.

In typical high-current applications, a 4.7 μ F low-ESR ceramic output capacitor is recommended. Different output capacitance values can be used to reduce ripple, shrink the solution size, and/or cut the cost of the solution. But changing the output capacitor may also require changing the flying capacitor and/or input capacitor to maintain good overall circuit performance. Performance of the LM2773 with different capacitor setups is discussed in the section [Recommended Capacitor Configurations](#).

High ESR in the output capacitor increases output voltage ripple. If a ceramic capacitor is used at the output, this is usually not a concern because the ESR of a ceramic capacitor is typically very low and has only a minimal impact on ripple magnitudes. If a different capacitor type with higher ESR is used (tantalum, for example), the ESR could result in high ripple. To eliminate this effect, the net output ESR can be significantly reduced by placing a low-ESR ceramic capacitor in parallel with the primary output capacitor. The low ESR of the ceramic capacitor will be in parallel with the higher ESR, resulting in a low net ESR based on the principles of parallel resistance reduction.

Input Capacitor and Input Voltage Ripple

The input capacitor (C_{IN}) is a reservoir of charge that aids a quick transfer of charge from the supply to the flying capacitors during the charge phase of operation. The input capacitor helps to keep the input voltage from drooping at the start of the charge phase when the flying capacitors are connected to the input. It also filters noise on the input pin, keeping this noise out of sensitive internal analog circuitry that is biased off the input line.

Much like the relationship between the output capacitance and output voltage ripple, input capacitance has a dominant, first-order effect on input ripple magnitude. Increasing (decreasing) the input capacitance will result in a proportional decrease (increase) in input voltage ripple. Input voltage, output current, and flying capacitance also will affect input ripple levels to some degree.

In typical high-current applications, a 1 μ F low-ESR ceramic capacitor is recommended on the input. Different input capacitance values can be used to reduce ripple, shrink the solution size, and/or cut the cost of the solution. But changing the input capacitor may also require changing the flying capacitor and/or output capacitor to maintain good overall circuit performance. Performance of the LM2773 with different capacitor setups is discussed below in [Recommended Capacitor Configurations](#).

Flying Capacitors

The flying capacitors (C_1 , C_2) transfer charge from the input to the output. Flying capacitance can impact both output current capability and ripple magnitudes. If flying capacitance is too small, the LM2773 may not be able to regulate the output voltage when load currents are high. On the other hand, if the flying capacitance is too large, the flying capacitor might overwhelm the input and output capacitors, resulting in increased input and output ripple.

In typical high-current applications, 1 μ F low-ESR ceramic capacitors are recommended for the flying capacitors. Polarized capacitors (tantalum, aluminum electrolytic, etc.) must not be used for the flying capacitor, as they could become reverse-biased during LM2773 operation.

Recommended Capacitor Configurations

The data in [Table 1](#) can be used to assist in the selection of capacitance configurations that best balances solution size and cost with the electrical requirements of the application.

As previously discussed, input and output ripple voltages will vary with output current and input voltage. The numbers provided show expected ripple voltage with $V_{IN} = 3.6V$ and a load current of 300mA. The table offers a first look at approximate ripple levels and provides a comparison of different capacitor configurations, but is not intended to ensure performance. With any capacitance configuration chosen, always verify that the performance of the ripple waveforms are suitable for the intended application. The same capacitance value must be used for all the flying capacitors.

Table 1. LM2773 Performance with Different Capacitor Configurations, 1.8V Mode ⁽¹⁾

CAPACITOR CONFIGURATION ($V_{IN} = 3.6V$)	TYPICAL OUTPUT RIPPLE
$C_{IN} = 1\mu F$, $C_{OUT} = 4.7\mu F$, $C_1, C_2 = 1\mu F$	10mV
$C_{IN} = 1\mu F$, $C_{OUT} = 2.2\mu F$, $C_1, C_2 = 1\mu F$	16mV
$C_{IN} = 0.47\mu F$, $C_{OUT} = 4.7\mu F$, $C_1, C_2 = 1\mu F$	12mV
$C_{IN} = 0.47\mu F$, $C_{OUT} = 3.3\mu F$, $C_1, C_2 = 1\mu F$	12mV
$C_{IN} = 0.47\mu F$, $C_{OUT} = 3.3\mu F$, $C_1, C_2 = 0.47\mu F$	13mV

(1) Refer to the text in the Recommended Capacitor Configurations section for detailed information on the data in this table

Layout Guidelines

Proper board layout will help to ensure optimal performance of the LM2773 circuit. The following guidelines are recommended:

- Place capacitors as close to the LM2773 as possible, and preferably on the same side of the board as the IC.
- Use short, wide traces to connect the external capacitors to the LM2773 to minimize trace resistance and inductance.
- Use a low resistance connection between ground and the GND pin of the LM2773. Using wide traces and/or multiple vias to connect GND to a ground plane on the board is most advantageous.

REVISION HISTORY

Changes from Original (May 2013) to Revision A	Page
• Changed layout of National Data Sheet to TI format	12

PACKAGING INFORMATION

Orderable Device	Status (1)	Package Type	Package Drawing	Pins	Package Qty	Eco Plan (2)	Lead/Ball Finish (6)	MSL Peak Temp (3)	Op Temp (°C)	Device Marking (4/5)	Samples
LM2773TL/NOPB	ACTIVE	DSBGA	YZR	9	250	Green (RoHS & no Sb/Br)	SNAGCU	Level-1-260C-UNLIM	-30 to 85	DJ	Samples
LM2773TLX/NOPB	ACTIVE	DSBGA	YZR	9	3000	Green (RoHS & no Sb/Br)	SNAGCU	Level-1-260C-UNLIM	-30 to 85	DJ	Samples

(1) The marketing status values are defined as follows:

ACTIVE: Product device recommended for new designs.

LIFEBUY: TI has announced that the device will be discontinued, and a lifetime-buy period is in effect.

NRND: Not recommended for new designs. Device is in production to support existing customers, but TI does not recommend using this part in a new design.

PREVIEW: Device has been announced but is not in production. Samples may or may not be available.

OBSELETE: TI has discontinued the production of the device.

(2) **RoHS:** TI defines "RoHS" to mean semiconductor products that are compliant with the current EU RoHS requirements for all 10 RoHS substances, including the requirement that RoHS substance do not exceed 0.1% by weight in homogeneous materials. Where designed to be soldered at high temperatures, "RoHS" products are suitable for use in specified lead-free processes. TI may reference these types of products as "Pb-Free".

RoHS Exempt: TI defines "RoHS Exempt" to mean products that contain lead but are compliant with EU RoHS pursuant to a specific EU RoHS exemption.

Green: TI defines "Green" to mean the content of Chlorine (Cl) and Bromine (Br) based flame retardants meet JS709B low halogen requirements of <=1000ppm threshold. Antimony trioxide based flame retardants must also meet the <=1000ppm threshold requirement.

(3) MSL, Peak Temp. - The Moisture Sensitivity Level rating according to the JEDEC industry standard classifications, and peak solder temperature.

(4) There may be additional marking, which relates to the logo, the lot trace code information, or the environmental category on the device.

(5) Multiple Device Markings will be inside parentheses. Only one Device Marking contained in parentheses and separated by a "-" will appear on a device. If a line is indented then it is a continuation of the previous line and the two combined represent the entire Device Marking for that device.

(6) Lead/Ball Finish - Orderable Devices may have multiple material finish options. Finish options are separated by a vertical ruled line. Lead/Ball Finish values may wrap to two lines if the finish value exceeds the maximum column width.

Important Information and Disclaimer:The information provided on this page represents TI's knowledge and belief as of the date that it is provided. TI bases its knowledge and belief on information provided by third parties, and makes no representation or warranty as to the accuracy of such information. Efforts are underway to better integrate information from third parties. TI has taken and continues to take reasonable steps to provide representative and accurate information but may not have conducted destructive testing or chemical analysis on incoming materials and chemicals. TI and TI suppliers consider certain information to be proprietary, and thus CAS numbers and other limited information may not be available for release.

In no event shall TI's liability arising out of such information exceed the total purchase price of the TI part(s) at issue in this document sold by TI to Customer on an annual basis.

TAPE AND REEL INFORMATION



QUADRANT ASSIGNMENTS FOR PIN 1 ORIENTATION IN TAPE



*All dimensions are nominal

Device	Package Type	Package Drawing	Pins	SPQ	Reel Diameter (mm)	Reel Width W1 (mm)	A0 (mm)	B0 (mm)	K0 (mm)	P1 (mm)	W (mm)	Pin1 Quadrant
LM2773TL/NOPB	DSBGA	YZR	9	250	178.0	8.4	1.57	1.57	0.76	4.0	8.0	Q1
LM2773TLX/NOPB	DSBGA	YZR	9	3000	178.0	8.4	1.57	1.57	0.76	4.0	8.0	Q1

TAPE AND REEL BOX DIMENSIONS

*All dimensions are nominal

Device	Package Type	Package Drawing	Pins	SPQ	Length (mm)	Width (mm)	Height (mm)
LM2773TL/NOPB	DSBGA	YZR	9	250	210.0	185.0	35.0
LM2773TLX/NOPB	DSBGA	YZR	9	3000	210.0	185.0	35.0

YZR0009

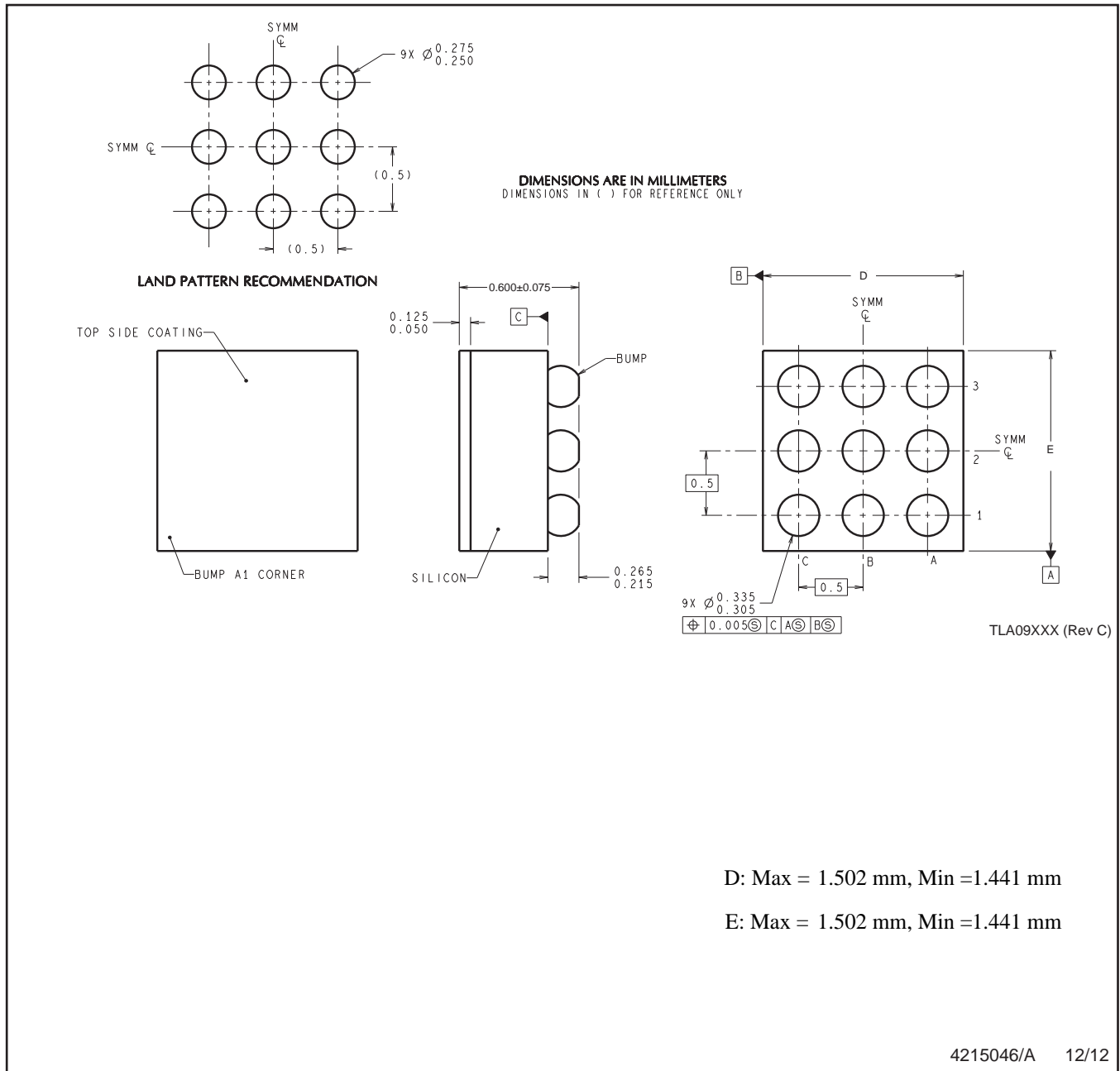

NOTES: A. All linear dimensions are in millimeters. Dimensioning and tolerancing per ASME Y14.5M-1994.
B. This drawing is subject to change without notice.

IMPORTANT NOTICE AND DISCLAIMER

TI PROVIDES TECHNICAL AND RELIABILITY DATA (INCLUDING DATASHEETS), DESIGN RESOURCES (INCLUDING REFERENCE DESIGNS), APPLICATION OR OTHER DESIGN ADVICE, WEB TOOLS, SAFETY INFORMATION, AND OTHER RESOURCES "AS IS" AND WITH ALL FAULTS, AND DISCLAIMS ALL WARRANTIES, EXPRESS AND IMPLIED, INCLUDING WITHOUT LIMITATION ANY IMPLIED WARRANTIES OF MERCHANTABILITY, FITNESS FOR A PARTICULAR PURPOSE OR NON-INFRINGEMENT OF THIRD PARTY INTELLECTUAL PROPERTY RIGHTS.

These resources are intended for skilled developers designing with TI products. You are solely responsible for (1) selecting the appropriate TI products for your application, (2) designing, validating and testing your application, and (3) ensuring your application meets applicable standards, and any other safety, security, or other requirements. These resources are subject to change without notice. TI grants you permission to use these resources only for development of an application that uses the TI products described in the resource. Other reproduction and display of these resources is prohibited. No license is granted to any other TI intellectual property right or to any third party intellectual property right. TI disclaims responsibility for, and you will fully indemnify TI and its representatives against, any claims, damages, costs, losses, and liabilities arising out of your use of these resources.

TI's products are provided subject to TI's Terms of Sale (www.ti.com/legal/termsofsale.html) or other applicable terms available either on ti.com or provided in conjunction with such TI products. TI's provision of these resources does not expand or otherwise alter TI's applicable warranties or warranty disclaimers for TI products.

Mailing Address: Texas Instruments, Post Office Box 655303, Dallas, Texas 75265
Copyright © 2019, Texas Instruments Incorporated