

Introduction

The STM8A/128-EVAL evaluation board is designed as a complete development platform for STMicroelectronics' STM8 core-based STM8Axx microcontroller with CAN2.0A/B compliant interface, I²C, SPI, two UART channels with smartcard, IrDA and LIN support, internal 2 Kbyte data Flash and 128 Kbyte code Flash, SWIM debugging support.

The full range of hardware features on the board helps you to evaluate all peripherals (including motor control, CAN, MicroSD card, smartcard, UART, LIN, IrDA) and develop your own applications. Extension headers make it possible to easily connect a daughterboard or wrapping board for your specific application.

Figure 1. STM8A/128-EVAL evaluation board

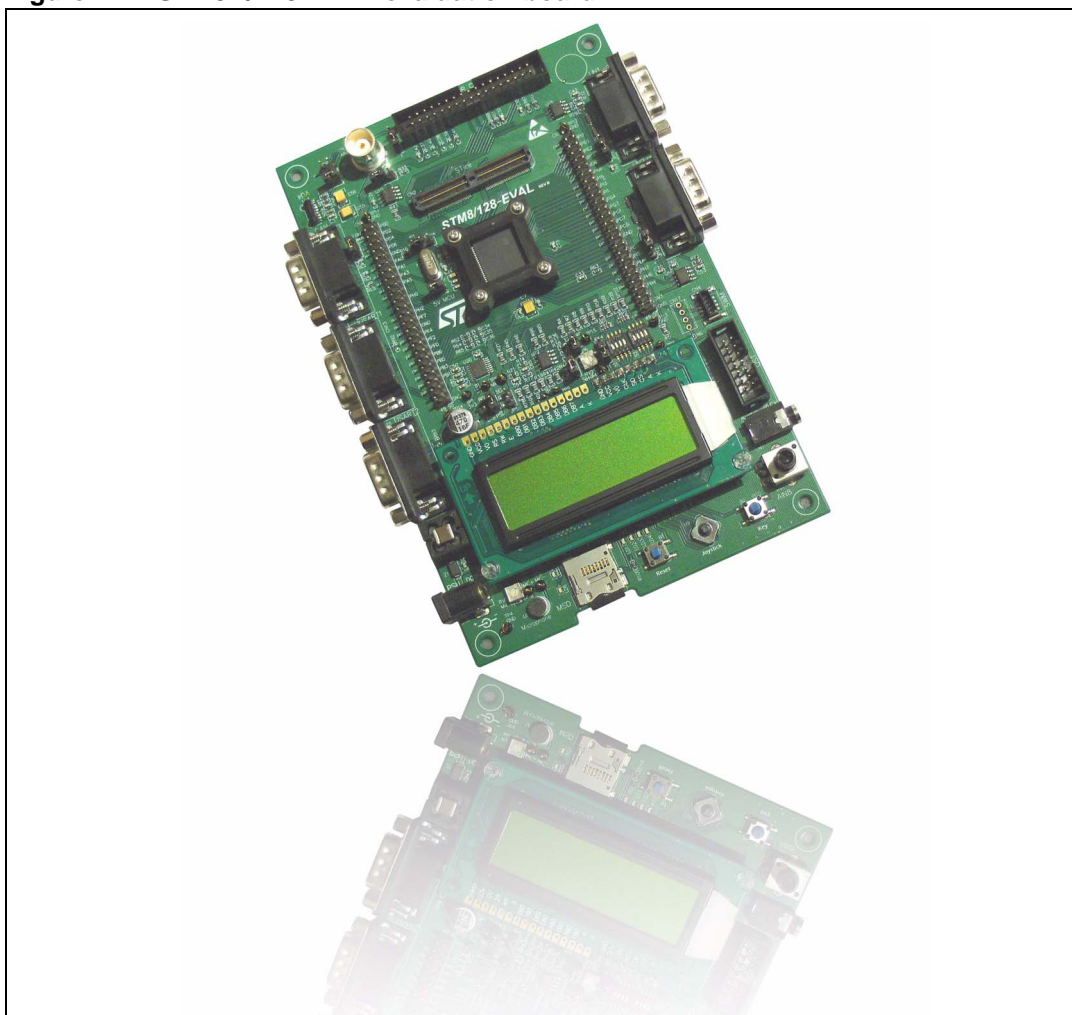

Contents

- 1 Features 6**

- 2 Hardware layout and configuration 7**
 - 2.1 Power supply 10
 - 2.2 Clock source 10
 - 2.3 Reset source 11
 - 2.4 Audio 11
 - 2.5 I²C EEPROM 12
 - 2.6 CAN 12
 - 2.7 RS-232 12
 - 2.8 LIN 13
 - 2.9 Motor control 13
 - 2.10 Smartcard 14
 - 2.11 MicroSD card 14
 - 2.12 Analog input 14
 - 2.13 IrDA 14
 - 2.14 Development and debug support 15
 - 2.15 Display and input devices 15

- 3 Connectors 16**
 - 3.1 STice connector CN2 16
 - 3.2 Analog input connector CN3 17
 - 3.3 SWIM connectors CN4 and CN17 18
 - 3.4 Power connector CN6 18
 - 3.5 Audio jack CN7 18
 - 3.6 CAN D-type 9-pin male connector CN8 19
 - 3.7 MicroSD connector CN9 19
 - 3.8 Motor control connector CN10 20
 - 3.9 LIN connectors CN11 and CN14 21
 - 3.10 Smartcard connector CN12 21
 - 3.11 RS-232 connectors CN13 and CN15 22

3.12	QST connector CN16	22
3.13	Daughterboard extension connectors CN1 and CN5	23
4	Schematics	27
Appendix A	STM8A/128-EVAL IO assignment	40
	Revision history	43

List of tables

Table 1.	Power related jumpers	10
Table 2.	Reset related jumpers	11
Table 3.	Audio related jumpers	11
Table 4.	I ² C EEPROM related jumper	12
Table 5.	CAN related jumpers	12
Table 6.	LIN related jumpers	13
Table 7.	Motor control related configuration	13
Table 8.	Connection between ST8024 and STM8Axx	14
Table 9.	IrDA related jumpers	14
Table 10.	LCD modules	15
Table 11.	STIce debugging connector (CN2) pin description	16
Table 12.	Analog input connector CN3 pin description	17
Table 13.	SWIM debugging connector CN4 and CN17 pin description	18
Table 14.	CAN D-type 9-pins male connector CN8 pin description	19
Table 15.	MicroSD connector CN9 pin description	19
Table 16.	Motor control connector CN10 pin description	20
Table 17.	LIN connector CN11 (LIN1) and CN14 (LIN2) pin connection	21
Table 18.	Smartcard connector CN12 pin description	21
Table 19.	RS-232 connector CN13 and CN15 pin description	22
Table 20.	QST connector CN16 pin description	22
Table 21.	Daughterboard extension connector CN1	23
Table 22.	Daughterboard extension connector CN5	25
Table 23.	STM8A/128-EVAL pin functions	40
Table 24.	Document revision history	43

List of figures

Figure 1.	STM8A/128-EVAL evaluation board	1
Figure 2.	Hardware block diagram	7
Figure 3.	STM8A/128-EVAL evaluation board top layout	8
Figure 4.	STM8A/128-EVAL evaluation board bottom layout	9
Figure 5.	STice debugging connector CN2 (top view)	16
Figure 6.	Analog input connector CN3 (bottom view)	17
Figure 7.	SWIM debugging connector CN4 (top view)	18
Figure 8.	Power supply connector CN6 (front view)	18
Figure 9.	CAN D-type 9-pins male connector CN8 (front view)	19
Figure 10.	MicroSD connector CN9 (front view)	19
Figure 11.	Motor control connector CN10 (top view)	20
Figure 12.	LIN connector CN11 (LIN1) and CN14 (LIN2) front view	21
Figure 13.	Smartcard connector CN12 (front view)	21
Figure 14.	RS-232 connectors CN13 and CN15 (top view)	22
Figure 15.	QST connector CN16 (front view)	22
Figure 16.	Microcontroller connections	28
Figure 17.	MCU	29
Figure 18.	LCD, joystick, CAN and I ² C EEPROM connections	30
Figure 19.	Multiplexer	31
Figure 20.	Audio peripherals	32
Figure 21.	Motor control	33
Figure 22.	STice connector and extension connectors	34
Figure 23.	QST connector	35
Figure 24.	LIN connectors	36
Figure 25.	UART and IrDA connectors	37
Figure 26.	Smartcard connections	38
Figure 27.	Power supply	39

1 Features

The STM8A/128-EVAL evaluation board features:

- Two 5 V power supply options: power jack or daughterboard
- Audio play and record
- 64 Mbyte or 128 Mbyte MicroSD card
- Both A&B type smartcard support
- 64 Kbit I²C EEPROM
- 2 channels of RS-232 communication
- IrDA transceiver
- 2 channels of LIN communication
- CAN2.0A/B compliant connection
- Inductor motor control connector
- SWIM and STice debug support
- 122 x 32 dot-matrix serial interface LCD module
- Joystick with 4-direction control and selector
- Reset, Wakeup, Tamper and User button
- 4 LEDs
- Extension connector for daughterboard or wrapping board

2 Hardware layout and configuration

The STM8A/128-EVAL evaluation board is designed around the STM8Axx microcontroller in an 80-pin TQFP package. The hardware block diagram [Figure 2](#) illustrates the connection between STM8Axx and peripherals (LCD, I²C EEPROM, UART, IrDA, LIN, Audio, CAN bus, smartcard, MicroSD card and motor control) and [Figure 3](#) will help you locate these features on the actual evaluation board.

Figure 2. Hardware block diagram

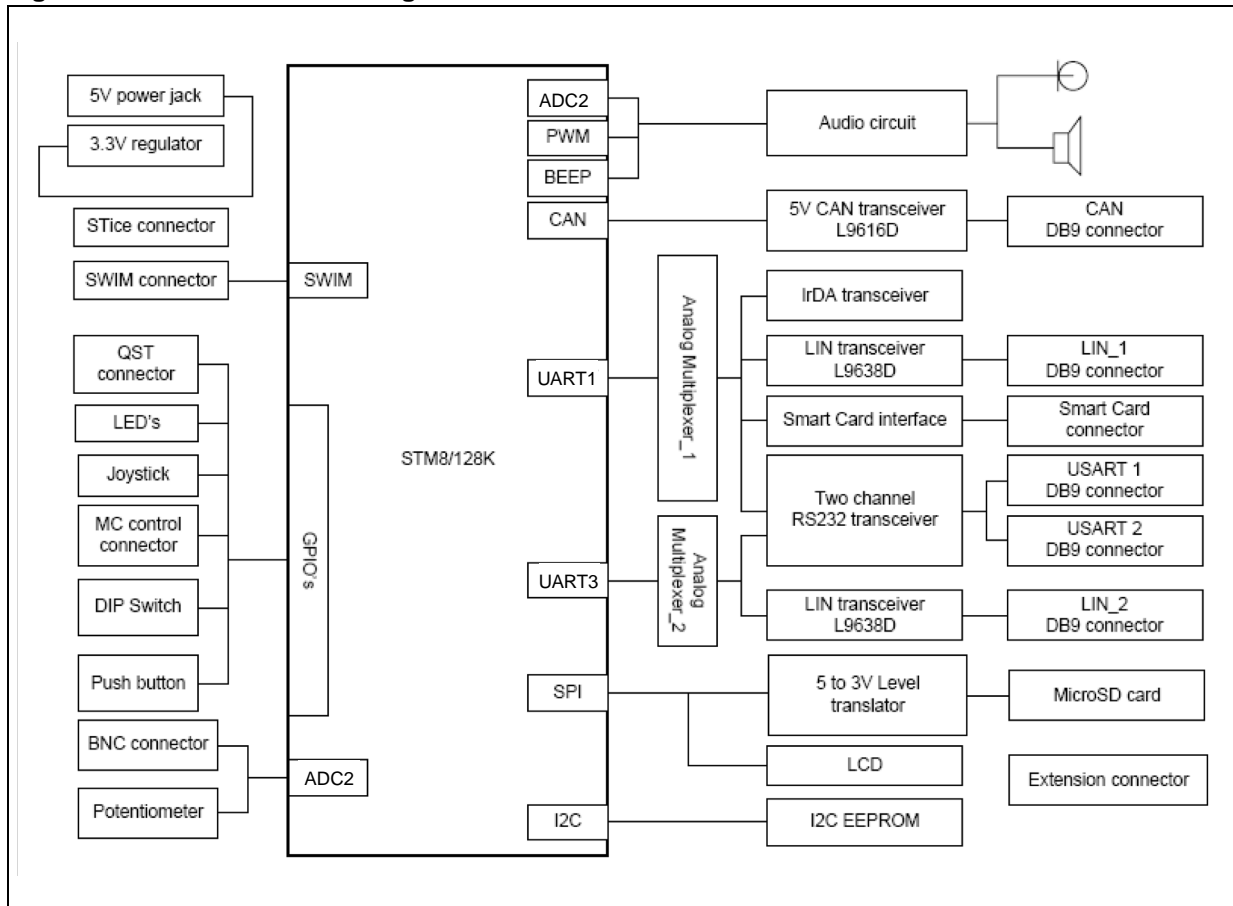
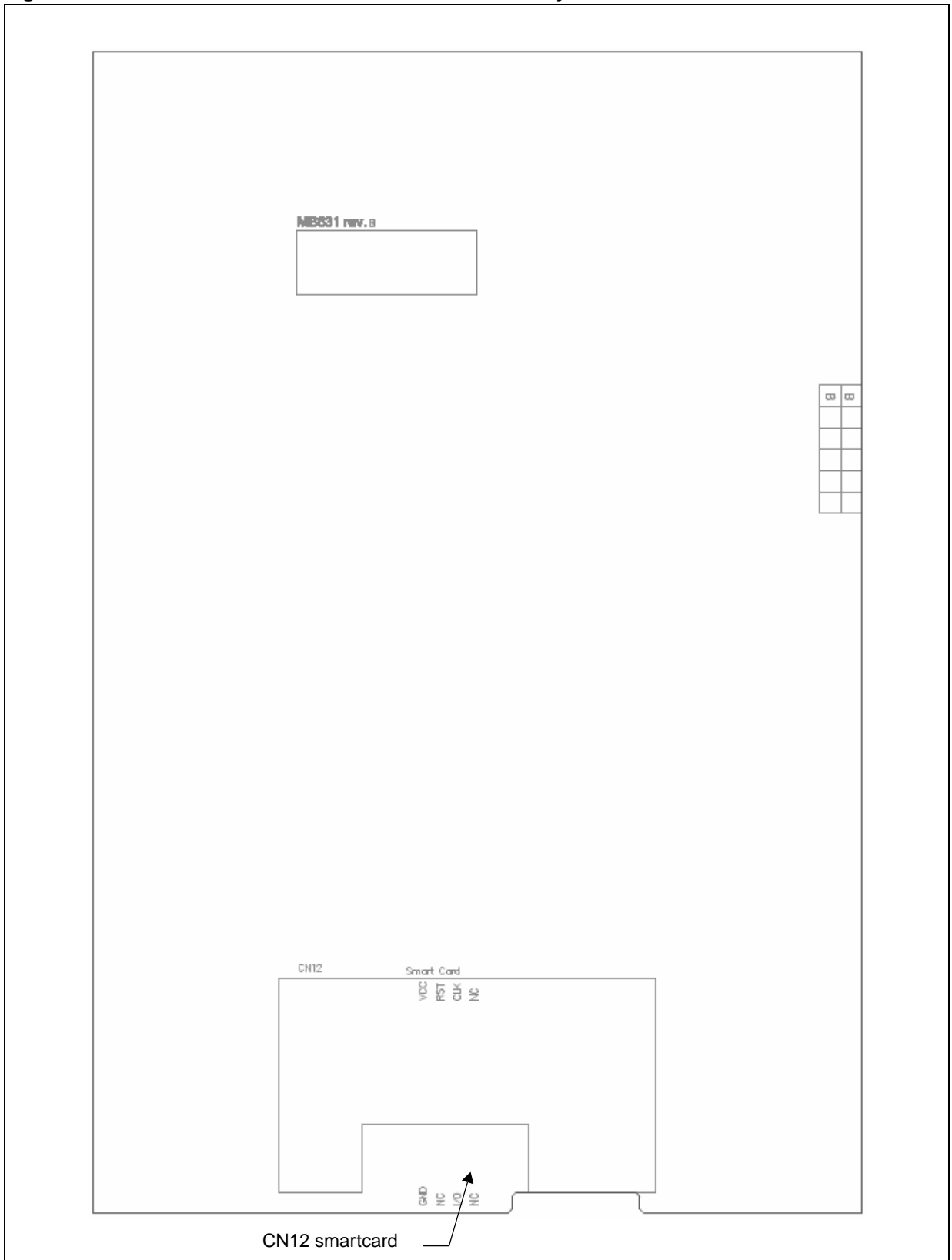

Figure 4. STM8A/128-EVAL evaluation board bottom layout





2.1 Power supply

The STM8A/128-EVAL evaluation board is designed to be powered by 5 V DC power supply and to be protected by the PolyZen (auto rearmable fuse) U2 from wrong power plug-in event. It is possible to configure the evaluation board to use any of following sources for the power supply.

- 5 V DC power adapter connected to CN6, the Power Jack on the board (PSU on silk screen for **power supply unit**).
- 5 V DC power from both CN5 and CN1, the extension connector for daughterboard (DTB for **daughterboard** on silkscreen).

The power supply is configured by setting the related jumpers JP3 and JP2 as described in [Table 1](#).

Table 1. Power related jumpers

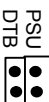
Jumper	Description
JP3	JP3 is used to select one of the two possible power supply resources. For power supply jack (CN6) to the STM8A/128-EVAL <u>only</u> , JP3 is set as shown. This is the default setting. 
	For power supply from the daughterboard connectors (CN5 and CN1) to STM8A/128-EVAL <u>only</u> , JP3 is set as shown. 
	 For power supply from power supply jack (CN6) to both STM8A/128-EVAL and daughterboard connected on CN5 and CN1, JP3 is set as shown (daughterboard must have not its own power supply connected).
JP2	Measures the consumption of both VDD and VDDA. Default setting: Fitted

The LED LD5 is lit when the STM8A/128-EVAL evaluation board is powered from the 5 V supply, and LD6 is also lit when the 3.3 V power regulator U3 is present.

2.2 Clock source

One clock source is available on the STM8A/128-EVAL evaluation board for STM8Axx:

- X1, 24 MHz crystal with socket for STM8Axx microcontroller

It can be removed from the socket when the internal RC clock is used.



2.3 Reset source

The reset signal of STM8A/128-EVAL evaluation board is low active and the reset sources include:

- Reset button B1
- Debugging Tools from connector CN4
- Daughterboard from CN5

The reset pin PA0 of STM8Axx is connected either to Reset button B1 or to GND by setting the jumper JP1 as described in [Table 2](#).

Table 2. Reset related jumpers



Jumper	Description
JP1	PA0 is connected to GND when JP1 is set as shown. It is used to maintain the reset pin at low level while STice is connected to the board. 
	PA0 is connected to Reset button when JP1 is set as shown. This is the default setting. 

2.4 Audio

The STM8A/128-EVAL evaluation board supports both audio recording and playback. This can be disabled or enabled by setting the jumpers JP4 and JP5. Audio volume can be adjusted using the potentiometer RV2, while the microphone amplifier gain can be adjusted using potentiometer RV3.

The beeper function pin PD4 is connected to the speaker via the JP14 jumper which can be used to select the source, beeper or PWM output from STM8Axx.

Table 3. Audio related jumpers

Jumper	Description
JP4	The audio power amplifier TS4871 is forced into standby mode when JP4 is not fitted. Default setting: fitted
JP5	The microphone pre-amplifier MAX4061 is forced into shutdown mode when JP5 is fitted. Default setting: not fitted
JP14	 Either beeper or PWM output can be selected as a source of speaker by setting the jumper JP14. The beeper is connected to speaker when JP14 is set as shown opposite.
	 The PWM output is connected to speaker when JP14 is set as shown opposite. This is the default setting.

2.5 I²C EEPROM

A 64 Kbit I²C EEPROM is connected to the I²C port of STM8Axx.

Write protection can be enabled by setting jumper JP8.

Table 4. I²C EEPROM related jumper



Jumper	Description
JP8	I ² C EEPROM U12 is protected from write operations when JP8 is not fitted. Default setting: fitted

2.6 CAN

The STM8A/128-EVAL evaluation board supports CAN2.0A/B compliant CAN bus communication based on 5 V CAN transceiver.

High-speed mode and low-speed mode are available and can be selected by setting JP6.

Table 5. CAN related jumpers

Jumper	Description
JP6	 <p>CAN transceiver operates in low-speed mode when JP6 is set as shown:</p>
	 <p>CAN transceiver operates in high-speed mode when JP6 is set as shown: This is the default setting.</p>
JP7	CAN terminal resistor is enabled when JP7 is fitted. Default setting: not fitted.

2.7 RS-232





Two D-type 9-pin connectors CN13 (UART1) and CN15 (UART3) are available on the STM8A/128-EVAL evaluation board. The USART1 connector is connected to channel 3 of the multiplexer U17, while the USART2 connector is connected to channel 1 of the multiplexer U18.

Note: *USART1 and UART3 are named USART1 and USART2 on the silkscreen (refer to [Figure 3](#)).*

2.8 LIN

Two D-type 9-pin LIN connectors CN11 (LIN1) and CN14 (LIN2) are available on the STM8A/128-EVAL evaluation board. The LIN1 connector is connected to channel 4 of the multiplexer U17, while the LIN2 connector is connected to channel 0 of the multiplexer U18. Either master or slave operation mode is supported by both LIN connectors and can be selected by setting jumpers JP11 and JP12. The LIN1 and LIN2 transceivers are powered by an external voltage from 6 V to 26 V connected to pin 9 of the LIN DB9 connector.

Table 6. LIN related jumpers



Jumper	Description
JP11	LIN1 operates in master mode when JP11 is set as shown: This is the default setting. 
	LIN1 operates in slave mode when JP11 is set as shown: 
JP12	LIN2 operates in master mode when JP12 is set as shown: 
	LIN2 operates in slave mode when JP12 is set as shown: This is the default setting. 

2.9 Motor control

The STM8A/128-EVAL evaluation board supports inductor motor control via a 34-pin connector CN10, which provides all required control and feedback signals to and from the motor power-driving board. Available signals on this connector include emergency stop, motor speed, 3-phase motor current, bus voltage, heatsink temperature coming from the motor driving board and 6 channels of PWM control signals going to the motor driving circuit.

Either PFC_PWM or Dissipative_Brake signal can be enabled by setting jumper JP13.

Table 7. Motor control related configuration

Jumper/resistor	Description
JP13	PFC_PWM signal is enabled and connected to PD0 when JP13 is set as shown: This is the default setting. 
	Dissipative_Brake signal is enabled and connected to PD0 when JP13 is set as shown: 
JP9	JP9 should be kept open when encoder signal is from pin 31 of CN10 while it should be kept closed when analog signal is from pin 31 of CN10 for special motor. Default setting: not fitted
R75	This 47 kΩ must be removed from the board to enable encoder phase A feature for motor control applications. The location of this resistor is indicated in Figure 3 .

2.10 Smartcard

STMicroelectronics smartcard interface chip ST8024 is used on STM8A/128-EVAL board for asynchronous 3 V and 5 V smartcards. It performs all supply protection and control functions based on the connections with STM8Axx listed in [Table 8](#):

Table 8. Connection between ST8024 and STM8Axx

Jumper	Description	
5V/3V	Smartcard power supply selection pin.	PG4
I/OUC	MCU data I/O line	PA5 through channel2 of multiplexer U17
XTAL1	Crystal or external clock input	PA6
OFF	Detect presence of a card, Interrupt to MCU	PE0
RSTIN	Card Reset Input from MCU	PG5
CMDVCC	Start activation sequence input (Active Low)	PG7

2.11 MicroSD card

The 64 Mbyte (or 128 MByte) MicroSD card SMS064FF (or SMS128FF) connected to the SPI of STM8Axx through a voltage level translator U11 (shared with LCD) is available on the board. MicroSD card Chip Select is managed by standard IO port PE5 and the card present is detected by port PE4.

2.12 Analog input

One BNC connector CN3 is connected to PF4, the ADC2 channel 12 of STM8Axx as external analog input.

2.13 IrDA

IrDA communication is supported by the IrDA transceiver U14 connected to the UART1 of STM8Axx through channel 1 of multiplexer U17.

It can be enabled or disabled by setting JP10.

Table 9. IrDA related jumpers

Jumper	Description
JP10	JP10 is used to shut down the IrDA transceiver. IrDA is enabled when JP10 is fitted, while IrDA is disabled when JP10 is not fitted. Default status: fitted.

2.14 Development and debug support

The debug connectors available on the STM8A/128-EVAL evaluation board are:

- CN2, 120-pin SAMTEC connector that supports STIce, the advanced emulation system from STMicroelectronics. The JP1 jumper must connect pin 2 together with pin 3 when STIce is present, as described in [Table 2: Reset related jumpers](#).
- CN4, ERNI 4-pin connector for SWIM debugging
- CN17, 2.54 mm pitch low-cost 4-pin connector footprint for SWIM debugging (not populated)

2.15 Display and input devices

The 122 x 32 Dot-matrix serial interface LCD (U13) and 4 general purpose LEDs (LD1, 2, 3, 4) are available as display devices. The LCD backlight can be switched ON or OFF by setting IO PH4. A 4-direction joystick with selection key and general purpose button (B2) are available as input devices.

Table 10. LCD modules

122 x 32 Dot Matrix LCD U13		
Pin on U13	Description	Pin connection
1	Vss	GND
2	Vcc	+5V
3	VO	-
4	CLK	PC5
5	SID	PC6
6	CS	PF0
7	A	+5V
8	K	To GND through a transistor

3 Connectors

3.1 STice connector CN2

Figure 5. STice debugging connector CN2 (top view)

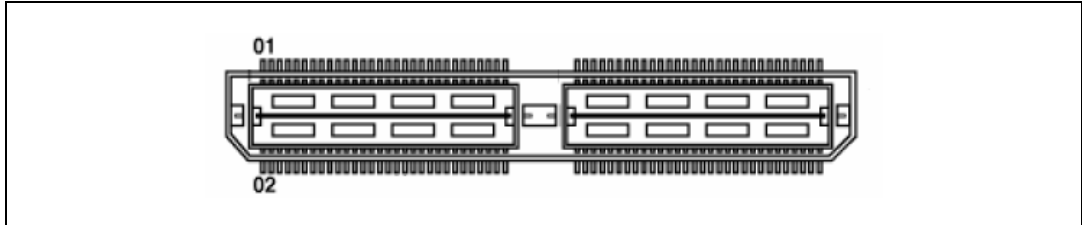

Table 11. STice debugging connector (CN2) pin description

Pin number	Description	Pin number	Description
1	PA0	2	PA1
3	PA2	4	GND
5	GND	6	VCAP
7	5V	8	5V
9	PA3	10	PA4
11	PA5	12	PA6
13	PH0	14	PH1
15	PH2	16	PH3
17	PF7	18	PF6
19	PF5	20	PF4
21	PF3	22	PF2
23	5V VDDA	24	GND
25	PF1	26	PF0
27	PB7	28	PB6
29	PB5	30	PB4
31	PB3	32	PB2
33	PB1	34	PB0
35	PH4	36	PH5
37	PH6	38	PH7
39	PE7	40	PE6
41	PE5	42	PC0
43	PC1	44	PC2
45	PC3	46	PC4
47	PC5	48	GND

Table 11. STice debugging connector (CN2) pin description (continued)

Pin number	Description	Pin number	Description
49	5V	50	PC6
51	PC7	52	PG0
53	PG1	54	PG2
55	PG3	56	PG4
57	PI0	58	NC
59	NC	60	NC
61	PI2	62	PI1
63	PI4	64	PI3
65	PG5	66	PI5
67	PG7	68	PG6
69	PE3	70	PE4
71	PE1	72	PE2
73	PI6	74	PE0
75	PD0	76	PI7
77	PD2	78	PD1
79	PD4	80	PD3
81	PD6	82	PD5
83	NC	84	PD7
85-120	NC		

3.2 Analog input connector CN3

Figure 6. Analog input connector CN3 (bottom view)

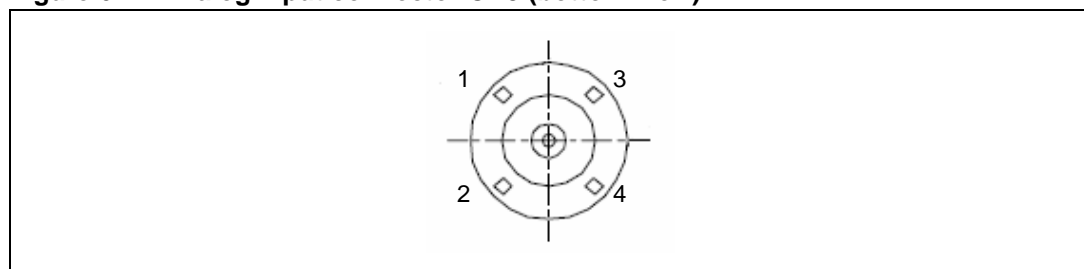

Table 12. Analog input connector CN3 pin description

Pin number	Description	Pin number	Description
1	GND	4	GND
2	GND	5	Analog input/PF4
3	GND		

3.3 SWIM connectors CN4 and CN17

Figure 7. SWIM debugging connector CN4 (top view)

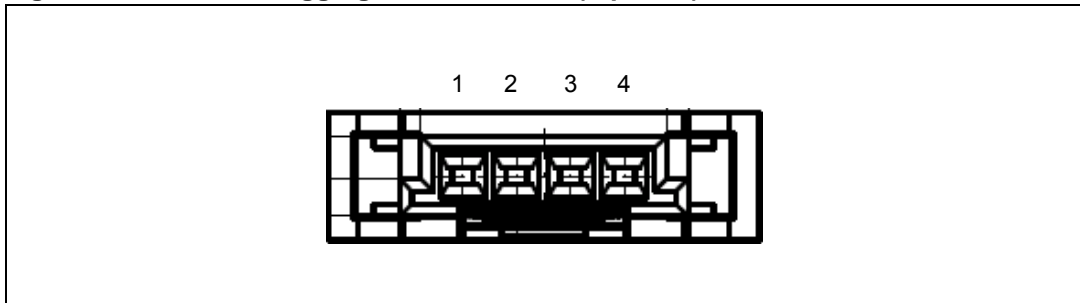

Table 13. SWIM debugging connector CN4 and CN17 pin description

Pin number	Description	Pin number	Description
1	VDD	2	PD1
3	GND	4	PA0 (RESET)

3.4 Power connector CN6

Your STM8A/128-EVAL evaluation board can be powered from a DC 5 V power supply via the external power supply jack (CN6) shown in [Figure 8](#). The central pin of CN6 must be positive.

Figure 8. Power supply connector CN6 (front view)

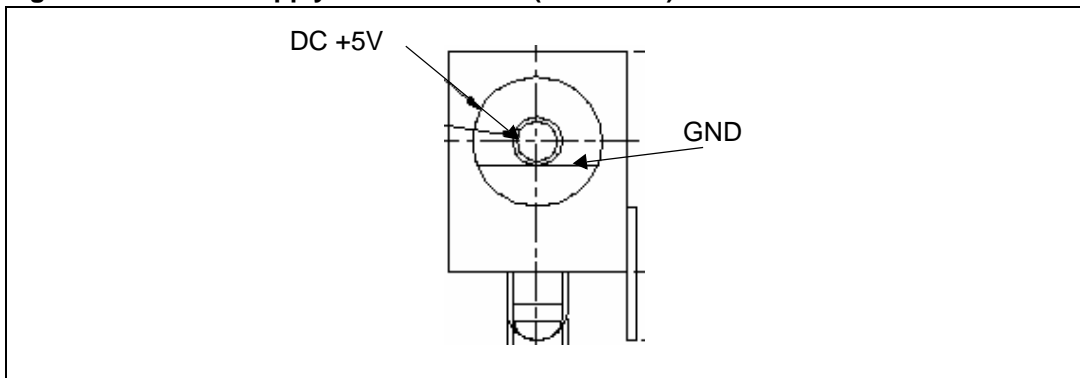

3.5 Audio jack CN7

A 3.5 mm mono audio jack CN7 is available on the STM8A/128-EVAL board. The speaker U5 is bypassed when an earphone is plugged into CN7.

3.6 CAN D-type 9-pin male connector CN8

Figure 9. CAN D-type 9-pins male connector CN8 (front view)

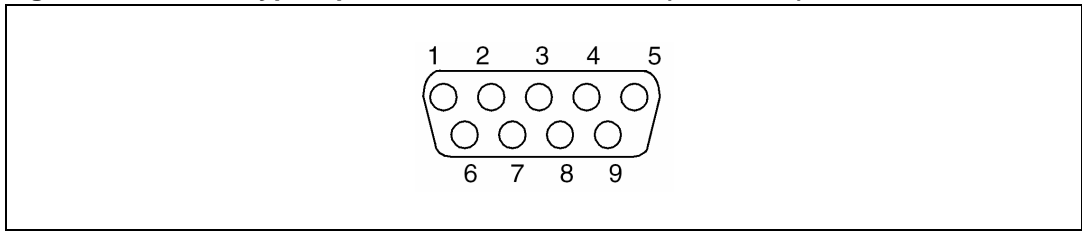

Table 14. CAN D-type 9-pins male connector CN8 pin description

Pin number	Description	Pin number	Description
1,4,8,9	NC	7	CANH
2	CANL	3,5,6	GND

3.7 MicroSD connector CN9

Figure 10. MicroSD connector CN9 (front view)

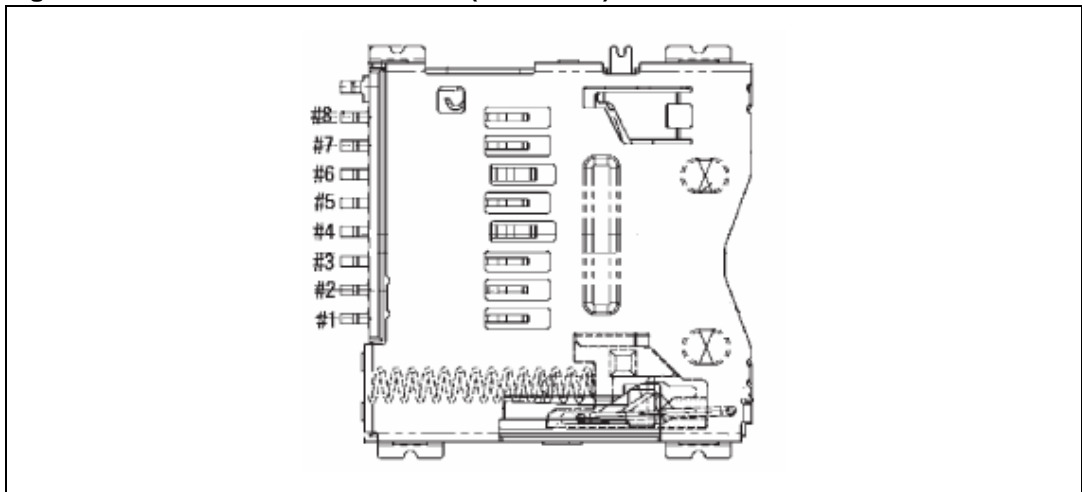

Table 15. MicroSD connector CN9 pin description

Pin number	Description	Pin number	Description
1	Reserved	5	SCLK/PC5
2	CS/PE5	6	Vss/GND
3	DI/PC6	7	DO/PC7
4	VDD	8	Reserved
9	GND	10	PE4 to detect card present

3.8 Motor control connector CN10

Figure 11. Motor control connector CN10 (top view)

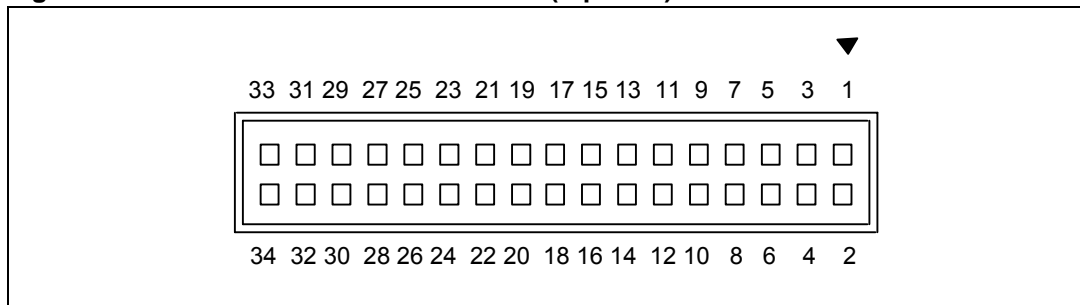

Table 16. Motor control connector CN10 pin description

Description	Pin of STM8Axx	Pin number of CN10	Pin number of CN10	Pin of STM8Axx	Description
EMERGENCY STOP	PE3	1	2		GND
PWM-UH	PC1	3	4		GND
PWM-UL	PH7	5	6		GND
PWM-VH	PC2	7	8		GND
PWM-VL	PH6	9	10		GND
PWM-WH	PC3	11	12		GND
PWM-WL	PH5	13	14	PB3	BUS VOLTAGE
PHASE A CURRENT	PB2	15	16		GND
PHASE B CURRENT	PB1	17	18		GND
PHASE C CURRENT	PB0	19	20		GND
NTC BYPASS RELAY	PG2	21	22		GND
DISSIPATIVE BRAKE PWM	PD0 shared with pin29	23	24		GND
+5V power		25	26	PE7	Heatsink temperature
PFC SYNC	PD2	27	28		3.3V power
PFC PWM	PD0 shared with pin23	29	30		GND
Encoder A	PD3	31	32		GND
Encoder B	PD4	33	34	PA3	Encoder Index

3.9 LIN connectors CN11 and CN14

Figure 12. LIN connector CN11 (LIN1) and CN14 (LIN2) front view

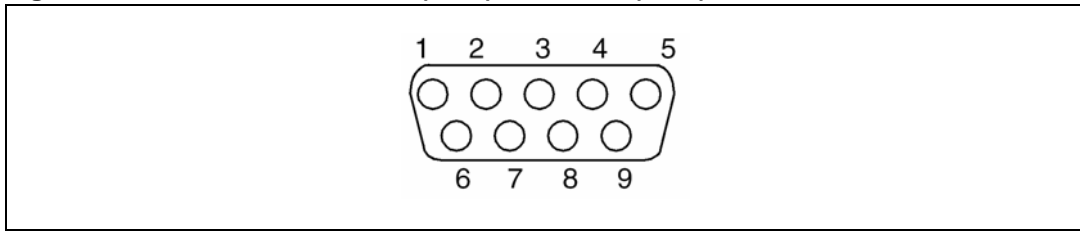

Table 17. LIN connector CN11 (LIN1) and CN14 (LIN2) pin connection

Pin number	Description	Pin number	Description
1	NC	6	NC
2	NC	7	LIN wire
3	GND	8	NC
4	NC	9	Battery power input
5	NC		

3.10 Smartcard connector CN12

Figure 13. Smartcard connector CN12 (front view)

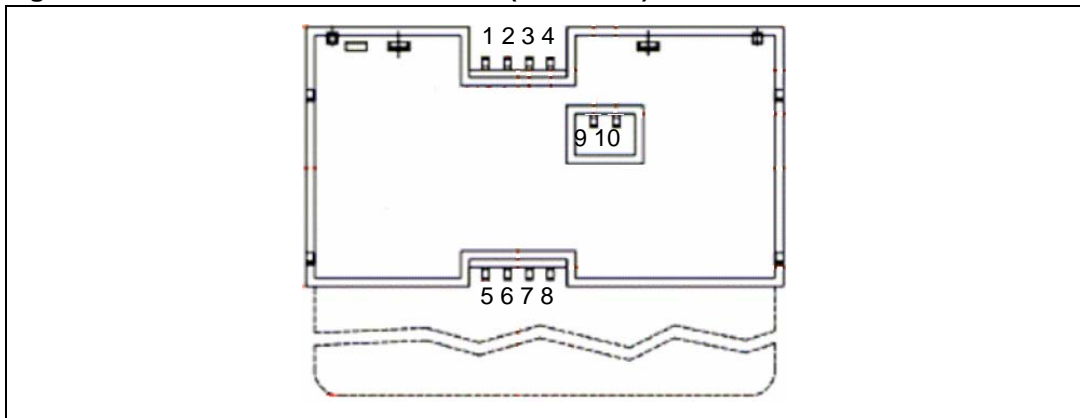

Table 18. Smartcard connector CN12 pin description

Pin number	Description	Pin number	Description
1	VCC	5	GND
2	RST	6	NC
3	CLK	7	I/O
4	NC	8	NC
9	Detection pin of card presence	10	Detection pin of card presence

3.11 RS-232 connectors CN13 and CN15

Figure 14. RS-232 connectors CN13 and CN15 (top view)

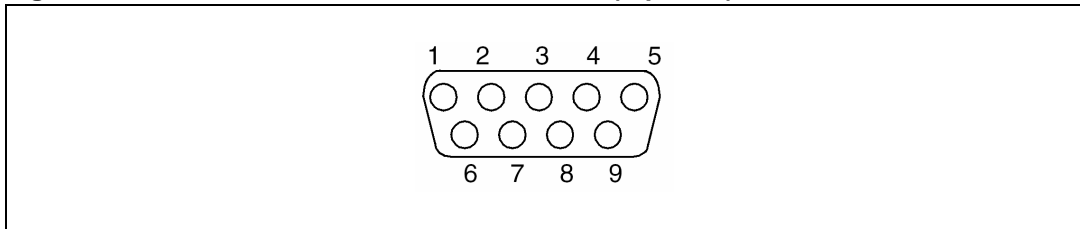

Table 19. RS-232 connector CN13 and CN15 pin description

Pin number	Description	Pin number	Description
1	NC	6	Connect to Pin 4
2	USART_RXD	7	Connect to Pin 8
3	USART_TXD	8	Connect to Pin 7
4	Connect to Pin 6	9	NC
5	GND		

3.12 QST connector CN16

The QST connector is designed to be connected to the QST evaluation board powered by DC 1.8 V to 5 V.

Figure 15. QST connector CN16 (front view)

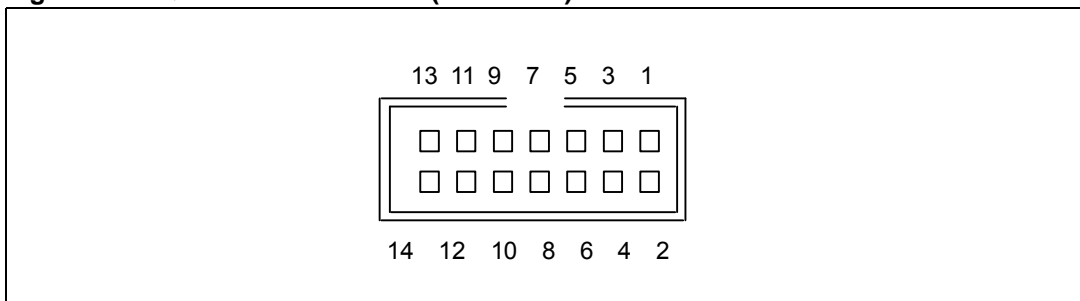

Table 20. QST connector CN16 pin description

Pin number	Description	Pin number	Description
1	+5V	2	+5V
3	PE1	4	PC5
5	PE2	6	PC6
7	PA3	8	PC7
9	PI0	10	PI1
11	PD3	12	QST_VDD
13	GND	14	GND

3.13 Daughterboard extension connectors CN1 and CN5

Two 50-pin male headers CN1 and CN5 can be used to connect a daughterboard or standard wrapping board to the STM8A/128-EVAL evaluation board. All GPI/Os are available on it. The space between the two connectors and the position of the power, GND and RESET pins (marked in gray in [Table 21](#) and [Table 22](#)) are defined as a standard which allows to develop common daughterboards for several evaluations boards. The standard width between CN1 pin1 and CN5 pin1 is 2700 mils (68.58 mm). This standard is implemented on the majority of evaluation boards. Each pin on CN1 and CN5 can be used by a daughterboard after disconnecting it from the corresponding function block on the STM8A/128-EVAL evaluation board. Please refer to [Table 21](#) and [Table 22](#) for details.

Table 21. Daughterboard extension connector CN1

Pin ⁽¹⁾	Description	Alternative function	How to disconnect function block on STM8A/128-EVAL board
1	GND	-	-
3	PI6	Dip-Switch 6	Keep S2 OFF and remove R99.
5	PE1	I2C EEPROM	Remove R95
7	PE3	MC connector pin1	Disconnect STM8A/128-EVAL evaluation board from motor power drive board, remove R60.
9	PG7	SmartCard_CMDVCC	-
11	PG5	SmartCard_RST	-
13	PI4	Dip-Switch 4	Keep S2 OFF and remove R58.
15	PI2	Dip-Switch 2	Keep S1 OFF and remove R9.
17	PI0	Dip-Switch 0	Keep S1 OFF and remove R7.
19	GND	-	-
21	PG2	MC connector pin21	Disconnect STM8A/128-EVAL evaluation board from motor power drive board
23	PG0	CAN_TX	-
25	PC6	SPI MOSI	Remove R34
27	PC4	PWM to speaker	-
29	PC3	MC connector pin11	Disconnect STM8A/128-EVAL evaluation board from motor power drive board
31	NC	-	-
33	PC1	MC connector pin3	Disconnect STM8A/128-EVAL evaluation board from motor power drive board
35	PE5	SD card select	Remove R34
37	PE7	MC connector pin26	Disconnect STM8A/128-EVAL evaluation board from motor power drive board, remove C33.
39	GND	-	-
41	PH5	MC connector pin13	Disconnect STM8A/128-EVAL evaluation board from motor power drive board
43	NC	-	-

Table 21. Daughterboard extension connector CN1 (continued)

Pin ⁽¹⁾	Description	Alternative function	How to disconnect function block on STM8A/128-EVAL board
45	NC	-	-
47	NC	-	-
49	D5V	-	-
2	PI7	Dip-Switch 7	Keep S2 OFF and remove R102.
4	PE0	SmartCard_OFF	Remove R76.
6	PE2	I2C EEPROM	Remove R96.
8	PE4	MicroSDCard Detect	Remove R101.
10	GND	-	-
12	PG6	LIN Multiplexer 1	Remove R97
14	PI5	Dip-Switch 5	Keep S2 OFF and remove R59.
16	PI3	Dip-Switch 3	Keep S1 OFF and remove R10.
18	PI1	Dip-Switch 1	Keep S1 OFF and remove R8.
20	PG4	SmartCard_3/5V	-
22	PG3	LIN_2_EN	-
24	PG1	CAN_Rx	Remove R43.
26	PC7	SPI MISO	Remove R34.
28	PC5	SPI CLK	Remove R34.
30	GND	-	-
32	NC	-	-
34	PC2	MC connector pin7	Disconnect STM8A/128-EVAL evaluation board from motor power drive board.
36	PC0	Push_Button	Remove R4.
38	PE6	Potentiometer	Remove R5.
40	PH7	MC connector pin5	Disconnect STM8A/128-EVAL evaluation board from motor power drive board.
42	PH6	MC connector pin9	Disconnect STM8A/128-EVAL evaluation board from motor power drive board.
44	PH4	-	-
46	NC	-	-
48	+3V3	-	-
50	GND	-	-

1. The power, ground and reset pins are marked in gray.

Table 22. Daughterboard extension connector CN5

Pin ⁽¹⁾	Description	Alternative function	How to disconnect component on STM8A/128-EVAL board
1	GND	-	-
3	PD1	SWIM	-
5	PD3	MC connector pin31	Keep JP9 on open, remove R75.
7	PD5	UART3_TX	Remove R91.
9	PD7	JOY_Select	Remove R39.
11	PA0/RESET	RESET# button	PA0 available on pin 12.
13	PA2	OSCOUT	Remove X1 from socket.
15	PA4	UART1_RX	Remove R90.
17	PA6	UART1_CK	-
19	D5V	-	-
21	NC	-	-
23	NC	-	-
25	PH1	LD3	Remove R13.
27	PH3	LD1	Remove R15.
29	PF6	USART_multiplexer2	Remove R69.
31	PF5	USART_multiplexer1	Remove R68.
33	PF3	MIC_IN	Remove R21.
35	PF1	Vref-	Remove R46.
37	PB7	JOY_DOWM	Remove R40.
39	GND	-	-
41	PB4	JOY_LEFT	Remove R41.
43	PB2	MC connector pin15	Disconnect STM8A/128-EVAL evaluation board from motor power drive board.
45	PB0	MC connector pin19	Disconnect STM8A/128-EVAL evaluation board from motor power drive board.
47	NC	-	-
49	NC	-	-
2	PD0	MC connector pin29 or pin23	Keep JP13 open.
4	PD2	MC connector pin27	Disconnect STM8A/128-EVAL evaluation board from motor power drive board.
6	PD4	MC connector pin33	Disconnect STM8A/128-EVAL evaluation board from motor power drive board.
8	PD6	UART3_RX	Remove R91.
10	GND	-	-
12	PA0	RESET# button	Keep JP1 open.

Table 22. Daughterboard extension connector CN5 (continued)

Pin ⁽¹⁾	Description	Alternative function	How to disconnect component on STM8A/128-EVAL board
14	PA1	OSCIN	Remove X1 from socket.
16	PA3	MC connector pin34	Disconnect STM8A/128-EVAL evaluation board from motor power drive board.
18	PA5	UART1_TX	Remove R90.
20	NC	-	-
22	PH0	LD4	Remove R12.
24	NC	-	-
26	PH2	LD2	Remove R14.
28	PF7	LIN1_EN	-
30	GND	-	-
32	PF4	BNC connector	-
34	PF2	Vref+	Remove R74.
36	PF0	LCD_CS	-
38	PB6	JOY_UP	Remove R44.
40	PB5	JOY_RIGHT	Remove R42.
42	PB3	MC connector pin14	Disconnect STM8A/128-EVAL evaluation board from motor power drive board. Remove R66 and C32.
44	PB1	MC connector pin17	Disconnect STM8A/128-EVAL evaluation board from motor power drive board.
46	NC	-	-
48	NC	-	-
50	GND	-	-

1. The power, ground and reset pins are marked in gray.

4 Schematics

This section provides the design schematics for the STM8A/128-EVAL board to help you implement these features in your applications. Schematics are provided for:

- Microcontroller connections, see [Figure 16](#)
- MCU, see [Figure 17](#)
- LCD, joystick, CAN and I²C EEPROM connections, see [Figure 18](#)
- Multiplexer, see [Figure 19](#)
- Audio peripherals, see [Figure 20](#)
- Motor control, see [Figure 21](#)
- STice connector and extension connectors, see [Figure 22](#)
- QST connector, see [Figure 23](#)
- LIN connectors, see [Figure 24](#)
- UART and IrDA connectors, see [Figure 25](#)
- Smartcard connections, see [Figure 26](#)
- Power supply, see [Figure 27](#)

Figure 16. Microcontroller connections

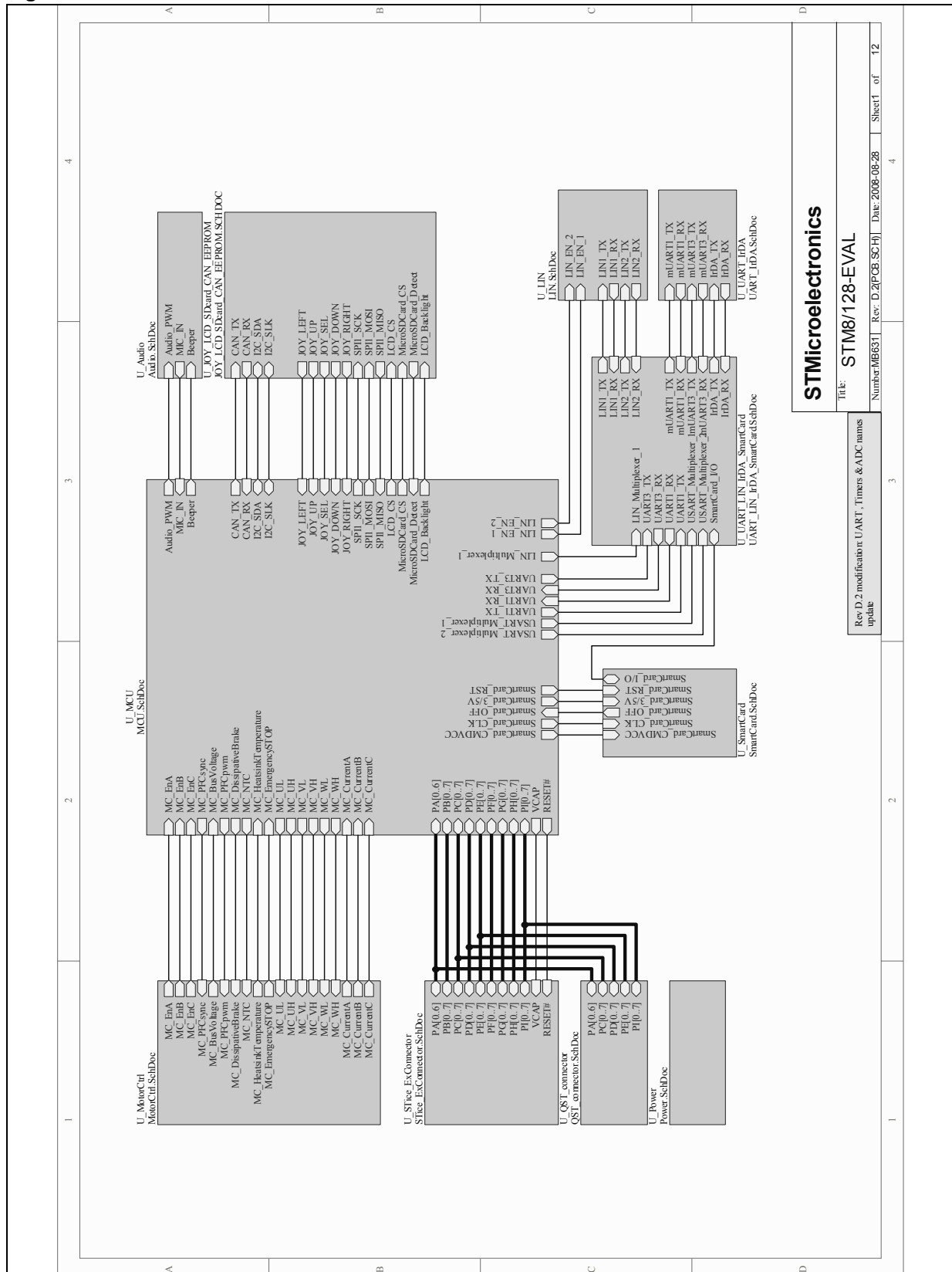
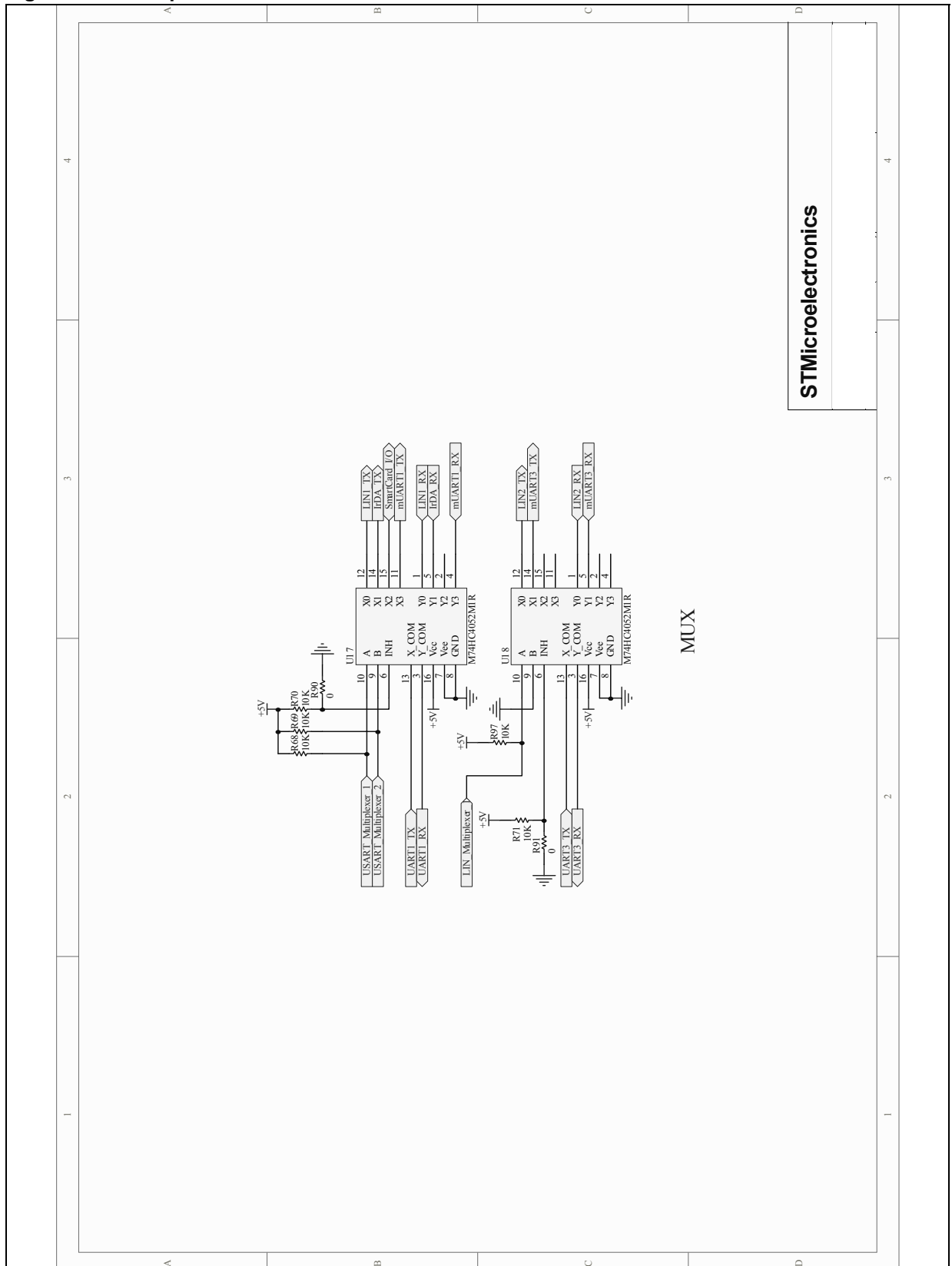

Figure 19. Multiplexer



STMicroelectronics

MUX

Figure 20. Audio peripherals

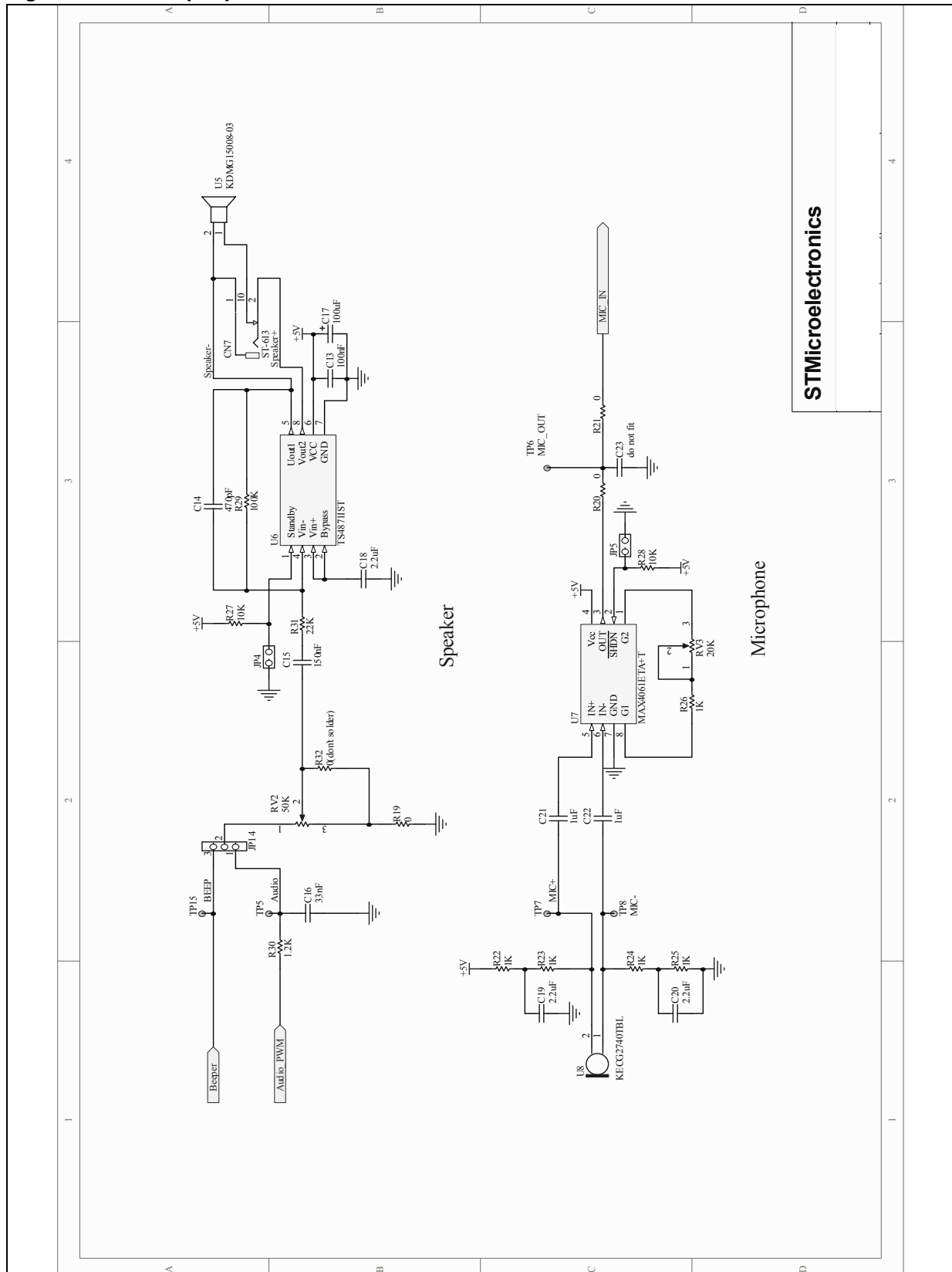

STMicroelectronics

Figure 21. Motor control

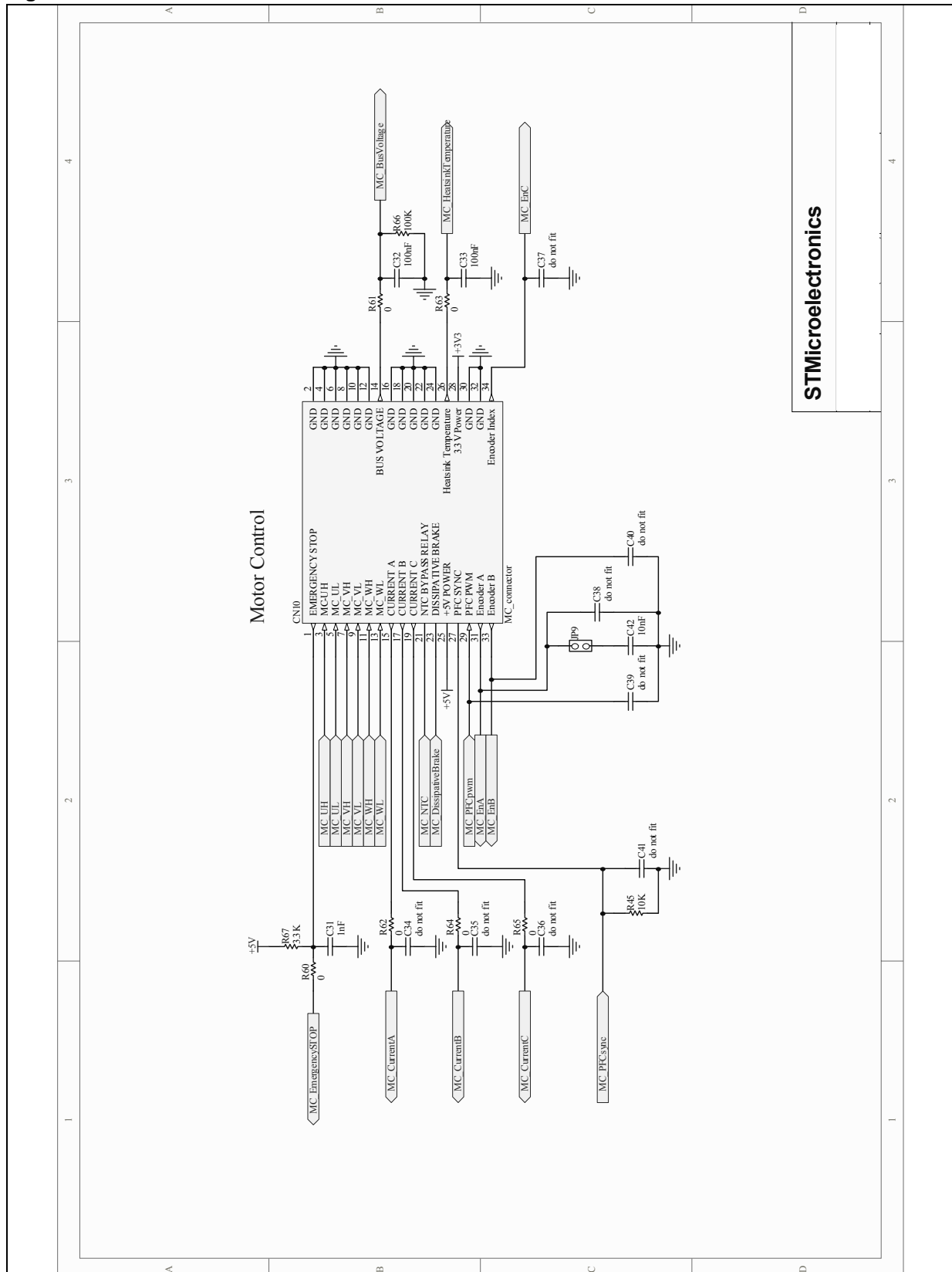

STMicroelectronics

Figure 22. STice connector and extension connectors

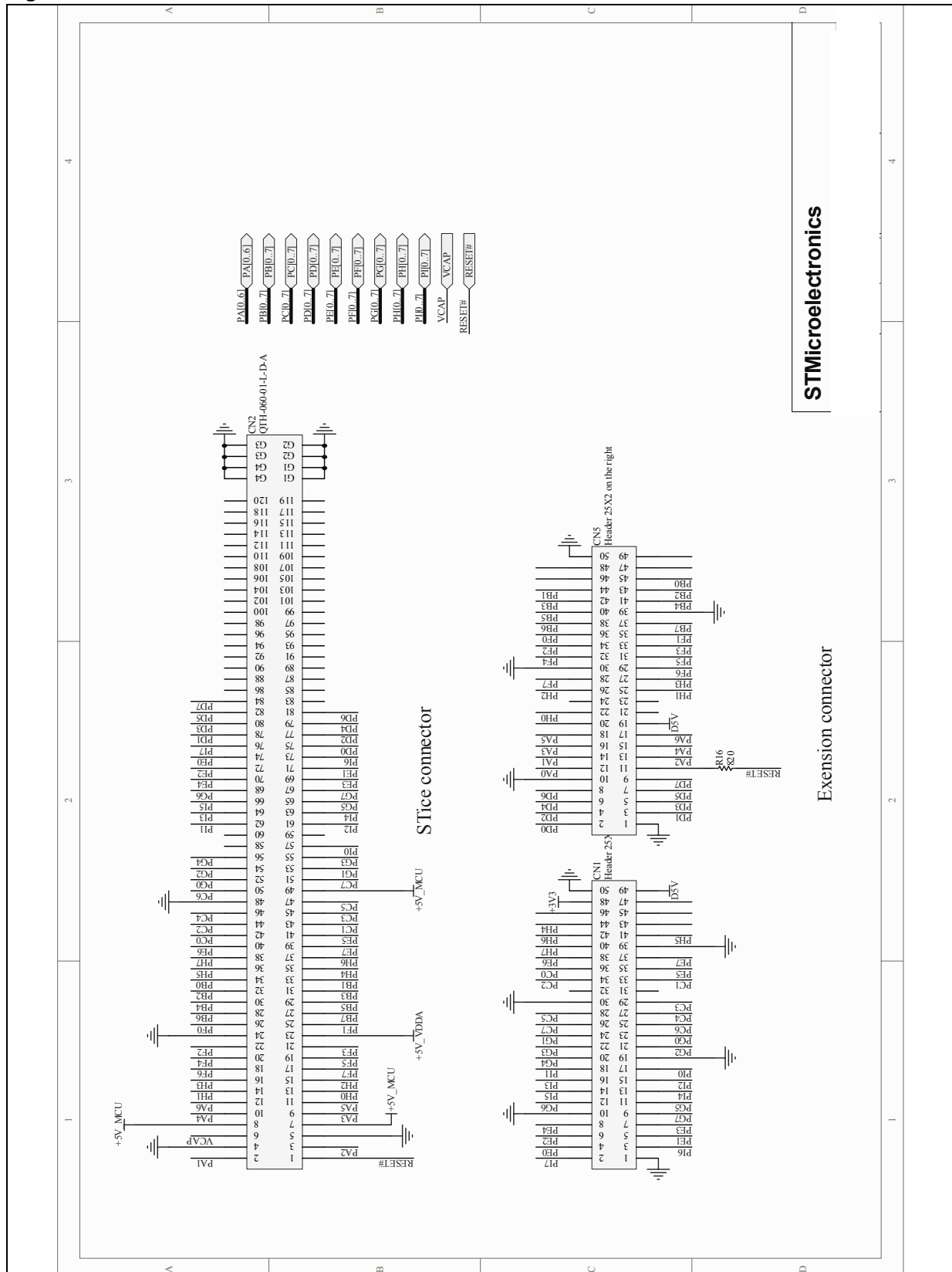
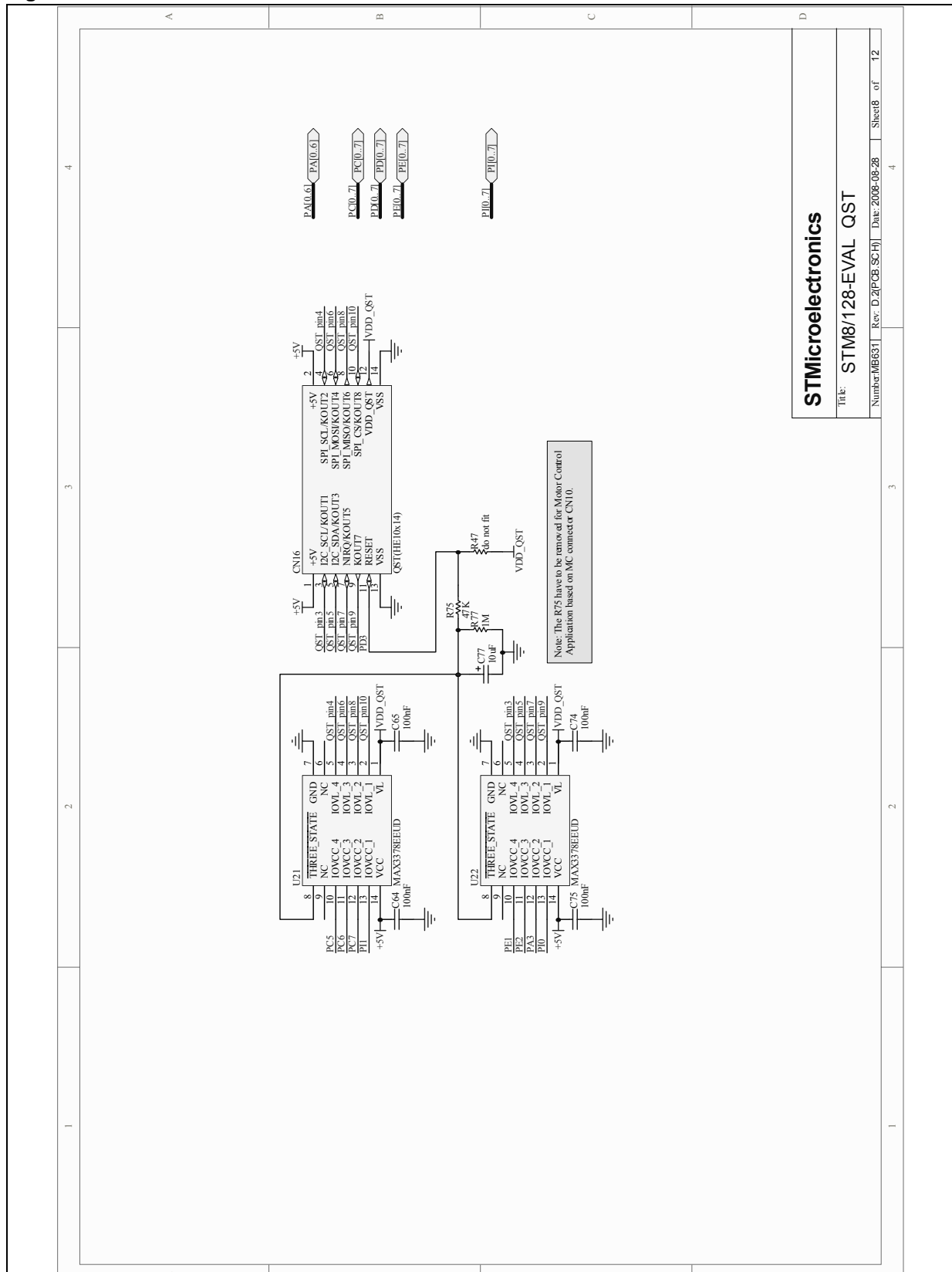
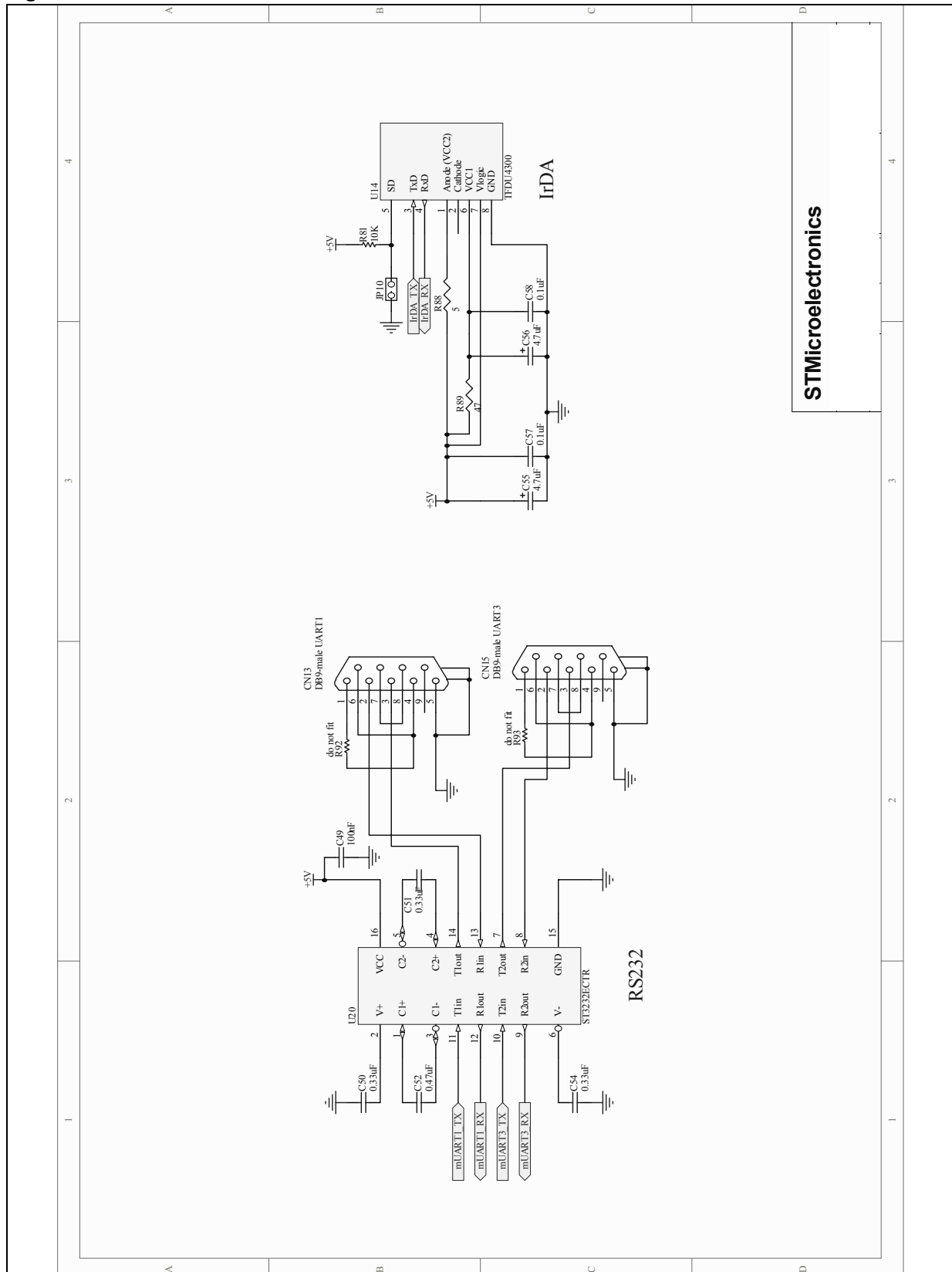

Figure 23. QST connector



STMicroelectronics
 Title: STM8/128-EVAL QST
 Number: MB631 Rev. D2[PCB SCH] Date: 2008-08-28 Sheet 8 of 12

Figure 25. UART and IrDA connectors



STMicroelectronics

Figure 26. Smartcard connections

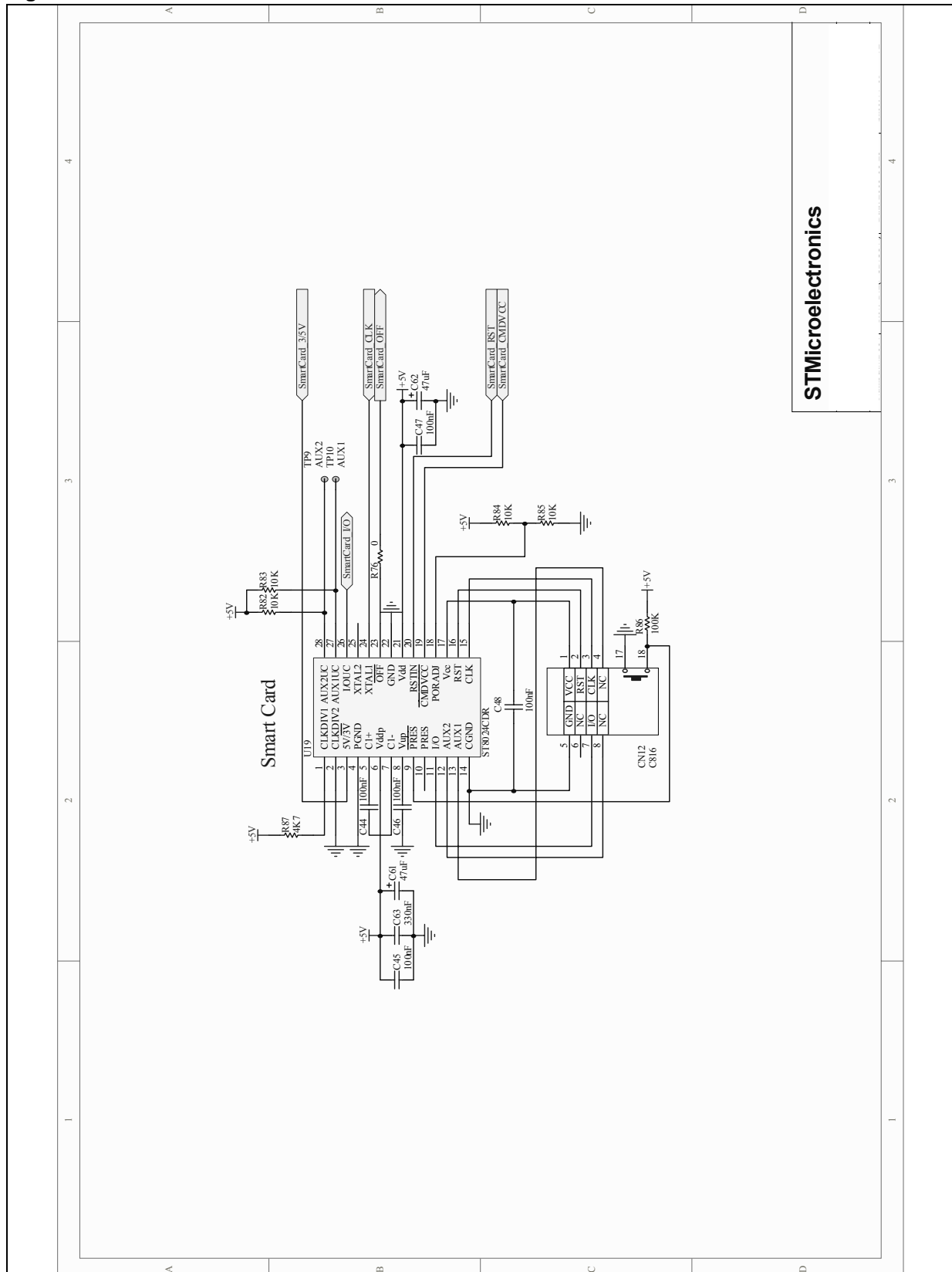

STMicroelectronics

Figure 27. Power supply

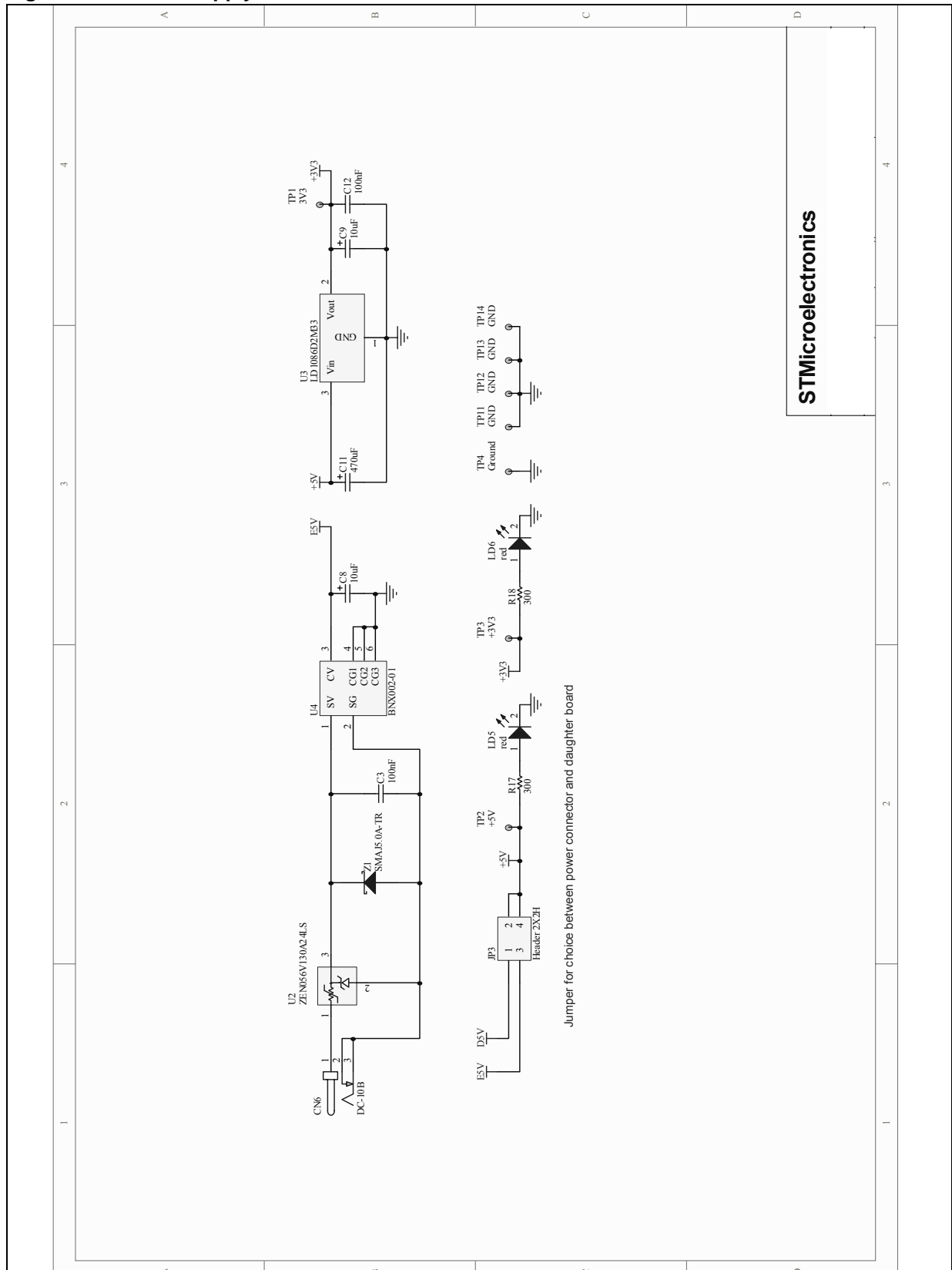

Appendix A STM8A/128-EVAL IO assignment

Table 23. STM8A/128-EVAL pin functions

Pin	Pin name	Main	Alternate function	STM8A/128-EVAL pin assignment
1	NRST / RESET	NRST	RESET	RESET
2	PA1 / OSCIN	PA1	OSCIN	OSCIN
3	PA2 / OSCOUT	PA2	OSCOUT	OSCOUT
4	VSSIO / VSSIO_1	VSSIO	VSSIO_1	VSS_DIG
5	VSS / VSS	VSS	VSS	VSS_IO_1
6	VCAP / VCAP	VCAP	VCAP	VCAP
7	VDD / VDD	VDD	VDD	VDD_DIG
8	VDDIO / VDDIO_1	VDDIO	VDDIO_1	VDD_IO_1
9	PA3 / TIM2_CH3	PA3	TIM2_CH3	MC_pin34/Measure Phase C / QST_pin7
10	PA4 / UART1_RX	PA4	UART1_RX	UART1_RX
11	PA5 / UART1_TX	PA5	UART1_TX	UART1_TX
12	PA6 / UART1_CK	PA6	UART1_CK	Smartcard_CLK
13	PH0 / GP_IO7	PH0	GP_IO7	PH0 - LD4
14	PH1 / GP_IO8	PH1	GP_IO8	PH1 - LD3
15	PH2 / GP_IO9	PH2	GP_IO9	PH2 - LD2
16	PH3 / GP_IO10	PH3	GP_IO10	PH3 - LD1
17	PF7 / AIN15	PF7	AIN15	LIN_1_EN
18	PF6 / AIN14	PF6	AIN14	USART multiplexer 2
19	PF5 / AIN13	PF5	AIN13	USART multiplexer 1
20	PF4 / AIN12	PF4	AIN12	BNC Connector
21	PF3 / AIN11	PF3	AIN11	AIN11 / Mic_Out
22	PF2 / VREF+	PF2	VREF+	VREF+
23	VDDA / VDDA	VDDA	VDDA	VDDA
24	VSSA / VSSA	VSSA	VSSA	VSSA
25	PF1 / VREF-	PF1	VREF-	VREF-
26	PF0 / AIN10	PF0	AIN10	LCD CS (for SPI)
27	PB7 / AIN7	PB7	AIN7	Joystick input down
28	PB6 / AIN6	PB6	AIN6	Joystick input up
29	PB5 / AIN5	PB5	AIN5	Joystick input right
30	PB4 / AIN4	PB4	AIN4	Joystick input left
31	PB3 / AIN3	PB3	AIN3	MC_pin14/ BUS voltage
32	PB2 / AIN2	PB2	AIN2	MC_pin15/ Current phase A

Table 23. STM8A/128-EVAL pin functions (continued)

Pin	Pin name	Main	Alternate function	STM8A/128-EVAL pin assignment
33	PB1 / AIN1	PB1	AIN1	MC_pin17/ Current phase B
34	PB0 / AIN0	PB0	AIN0	MC_pin19 / Current phase C
35	PH4 / TIM1_ETR	PH4	TIM1_ETR	LCD backlight control
36	PH5 / TIM1_CH3N	PH5	TIM1_CH3N	MC_pin13/T1_NCH3 WL
37	PH6 / TIM1_CH2N	PH6	TIM1_CH2N	MC_pin9/T1_NCH2 VL
38	PH7 / TIM1_CH1N	PH7	TIM1_CH1N	MC_pin5/T1_NCH1 UL
39	PE7 / AIN8	PE7	AIN8	MC_pin26/Heatsink temp
40	PE6 / AIN9	PE6	AIN9	Potentiometer read
41	PE5 / SPI_NSS	PE5	SPI_NSS	SD Card CS (for SPI)
42	PC0 / ADC_ETR	PC0	ADC_ETR	Push_button
43	PC1 / TIM1_CH1	PC1	TIM1_CH1	MC_pin3/T1_CH1 UH
44	PC2 / TIM1_CH2	PC2	TIM1_CH2	MC_pin7/T1_CH2 VH
45	PC3 / TIM1_CH3	PC3	TIM1_CH3	MC_pin11/T1_CH3 WH
46	PC4 / TIM1_CH4	PC4	TIM1_CH4	PWM to speaker
47	PC5 / SPI_SCK	PC5	SPI_SCK	SPI SCK / QST_pin4
48	VSSIO / VSSIO_2	VSSIO	VSSIO_2	VSS_IO
49	VDDIO / VDDIO_2	VDDIO	VDDIO_2	VDD_IO
50	PC6 / SPI_MOSI	PC6	SPI_MOSI	SPI MOSI / QST_pin6
51	PC7 / SPI_MISO	PC7	SPI_MISO	SPI MISO / QST_pin8
52	PG0 / CAN_Tx	PG0	CAN_Tx	CAN_Tx
53	PG1 / CAN_Rx	PG1	CAN_Rx	CAN_Rx
54	PG2 / GP_IO1	PG2	GP_IO1	MC_pin21/ NTC Bypass relay
55	PG3 / GP_IO2	PG3	GP_IO2	LIN_2_EN
56	PG4 / GP_IO3	PG4	GP_IO3	Smartcard_3/5V
57	PI0 / GP_IO11	PI0	GP_IO11	Dip-switch 0 / QST_pin9
58	PI1 / GP_IO12	PI1	GP_IO12	Dip-switch 1 / QST_pin10
59	PI2 / GP_IO13	PI2	GP_IO13	Dip-switch 2
60	PI3 / GP_IO14	PI3	GP_IO14	Dip-switch 3
61	PI4 / GP_IO15	PI4	GP_IO15	Dip-switch 4
62	PI5 / GP_IO16	PI5	GP_IO16	Dip-switch 5
63	PG5 / GP_IO4	PG5	GP_IO4	Smartcard_RST
64	PG6 / GP_IO5	PG6	GP_IO5	LIN multiplexer 1
65	PG7 / GP_IO6	PG7	GP_IO6	SmartCard_CMDVCC
66	PE4 / SMB_Alert	PE4	SMB_Alert	MicroSDcard detect
67	PE3 / TIM1_BKIN	PE3	TIM1_BKIN	MC_pin1/T1_BRK emergency

Table 23. STM8A/128-EVAL pin functions (continued)

Pin	Pin name	Main	Alternate function	STM8A/128-EVAL pin assignment
68	PE2 / I2C_SDA	PE2	I2C_SDA	I2C_SDA / EEPROM / QST_pin5
69	PE1 / I2C_SCL	PE1	I2C_SCL	I2C_SCLK / EEPROM / QST_pin3
70	PE0 / MCO	PE0	MCO	Smartcard_OFF
71	PI6 / GP_IO17	PI6	GP_IO17	Dip-switch 6
72	PI7 / GP_IO18	PI7	GP_IO18	Dip-switch 7
73	PD0 / TIM3_CH2	PD0	TIM3_CH2	MC_pin29/PFC_PWM, or MC_pin23/ dissipative brake. Selected by a jumper
74	PD1 / SWIM	PD1	SWIM	SWIM
75	PD2 / TIM3_CH1	PD2	TIM3_CH1	MC_pin27/PFC SYNC
76	PD3 / TIM2_CH2	PD3	TIM2_CH2	MC_pin31/Measure Phase A / QST_pin11
77	PD4 / TIM2_CH1	PD4	TIM2_CH1	MC_pin33/Measure Phase B /BEEP
78	PD5 / UART3_TX	PD5	UART3_TX	UART3_TX
79	PD6 / UART3_RX	PD6	UART3_RX	UART3_RX
80	PD7 / TLI	PD7	TLI	Joystick input selection

Revision history

Table 24. Document revision history

Date	Revision	Changes
14-May-2010	1	Initial release.

Please Read Carefully:

Information in this document is provided solely in connection with ST products. STMicroelectronics NV and its subsidiaries ("ST") reserve the right to make changes, corrections, modifications or improvements, to this document, and the products and services described herein at any time, without notice.

All ST products are sold pursuant to ST's terms and conditions of sale.

Purchasers are solely responsible for the choice, selection and use of the ST products and services described herein, and ST assumes no liability whatsoever relating to the choice, selection or use of the ST products and services described herein.

No license, express or implied, by estoppel or otherwise, to any intellectual property rights is granted under this document. If any part of this document refers to any third party products or services it shall not be deemed a license grant by ST for the use of such third party products or services, or any intellectual property contained therein or considered as a warranty covering the use in any manner whatsoever of such third party products or services or any intellectual property contained therein.

UNLESS OTHERWISE SET FORTH IN ST'S TERMS AND CONDITIONS OF SALE ST DISCLAIMS ANY EXPRESS OR IMPLIED WARRANTY WITH RESPECT TO THE USE AND/OR SALE OF ST PRODUCTS INCLUDING WITHOUT LIMITATION IMPLIED WARRANTIES OF MERCHANTABILITY, FITNESS FOR A PARTICULAR PURPOSE (AND THEIR EQUIVALENTS UNDER THE LAWS OF ANY JURISDICTION), OR INFRINGEMENT OF ANY PATENT, COPYRIGHT OR OTHER INTELLECTUAL PROPERTY RIGHT.

UNLESS EXPRESSLY APPROVED IN WRITING BY AN AUTHORIZED ST REPRESENTATIVE, ST PRODUCTS ARE NOT RECOMMENDED, AUTHORIZED OR WARRANTED FOR USE IN MILITARY, AIR CRAFT, SPACE, LIFE SAVING, OR LIFE SUSTAINING APPLICATIONS, NOR IN PRODUCTS OR SYSTEMS WHERE FAILURE OR MALFUNCTION MAY RESULT IN PERSONAL INJURY, DEATH, OR SEVERE PROPERTY OR ENVIRONMENTAL DAMAGE. ST PRODUCTS WHICH ARE NOT SPECIFIED AS "AUTOMOTIVE GRADE" MAY ONLY BE USED IN AUTOMOTIVE APPLICATIONS AT USER'S OWN RISK.

Resale of ST products with provisions different from the statements and/or technical features set forth in this document shall immediately void any warranty granted by ST for the ST product or service described herein and shall not create or extend in any manner whatsoever, any liability of ST.

ST and the ST logo are trademarks or registered trademarks of ST in various countries.

Information in this document supersedes and replaces all information previously supplied.

The ST logo is a registered trademark of STMicroelectronics. All other names are the property of their respective owners.

© 2010 STMicroelectronics - All rights reserved

STMicroelectronics group of companies

Australia - Belgium - Brazil - Canada - China - Czech Republic - Finland - France - Germany - Hong Kong - India - Israel - Italy - Japan - Malaysia - Malta - Morocco - Philippines - Singapore - Spain - Sweden - Switzerland - United Kingdom - United States of America

www.st.com