

BROADBAND TIME DELAY & PHASE SHIFTER SMT, 8 - 23 GHz



Typical Applications

The HMC877LC3 is ideal for:

- Synchronization of clock and data
- Transponder design
- Broadband Test & Measurement
- RF ATE Applications

Features

- Very Wide Bandwidth: 8 - 23 GHz
- Continuous Adjustable Delay Range: 500° (1.4 UI^[1])
- Single-Ended or Differential Operation
- Adjustable Differential Output Voltage
Swing: 500 - 950 mVp-p @ 16 GHz
- Delay Control Modulation Bandwidth: 2.5 GHz
- Single Supply: +3.3V
- 16 Lead Ceramic 3x3mm SMT Package: 9mm²

Functional Diagram

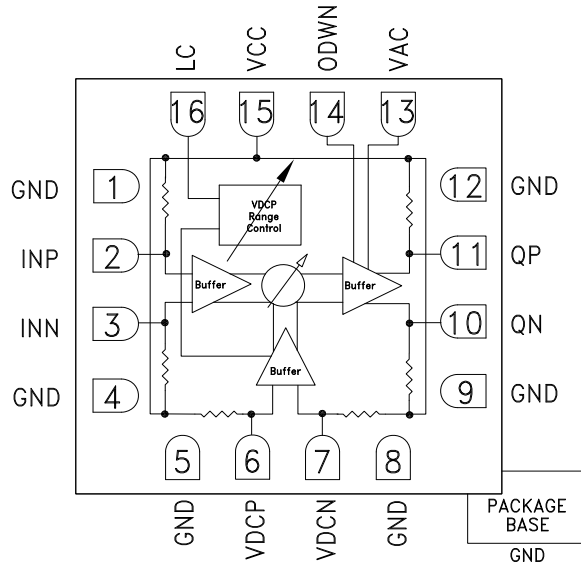

General Description

The HMC877LC3 is a phase shifter/time delay with 0 to 500°(1.4 UI) continuously adjustable shift/delay range. The delay control is linearly monotonic with respect to the differential control voltage (VDCP, VDCN) and the control input has a modulation bandwidth of 2.5 GHz. The device provides a differential output voltage with constant amplitude for single-ended or differential input voltages above the input sensitivity level, while the output voltage swing may be adjusted using the VAC control pin. The HMC877LC3 features internal temperature compensation and bias circuitry to minimize delay variations with temperature. The device also features a delay control voltage range adjustment pin, LC. All RF input and outputs of the HMC877LC3 are internally terminated with 50 Ohms to Vcc, and may either be AC or DC coupled. Output pins can be connected directly to a 50 Ohm to Vcc terminated system, while DC blocking capacitors must be used if the terminated system input is 50 Ohms to a DC voltage other than Vcc. The HMC877LC3 is available in ROHS-compliant 3x3 mm SMT package.

Electrical Specifications, $T_A = +25^\circ \text{C}$, $V_{CC} = 3.3\text{V}$, $GND=ODWN = 0\text{V}$

Parameter	Conditions	Min.	Typ.	Max.	Units
Power Supply Voltage	± %5 Tolerance	3.135	3.3	3.465	V
Power Supply Current	ODWN = 0V	175	190	215	mA
Phase Shift Range	@ 10 GHz		504		Deg
	@ 16 GHz		498		Deg
	@ 22 GHz		485		Deg
Time Delay Range	@ 10 GHz		1.4		UI
	@ 16 GHz		1.38		UI
	@ 22 GHz		1.35		UI
Delay Control Modulation Bandwidth			2.5		GHz
Delay Control Voltage (VDCP)		VCC-0.6		VCC+0.6	V

[1] The UI stands for unit interval

BROADBAND TIME DELAY & PHASE SHIFTER SMT, 8 - 23 GHz



Electrical Specifications, $T_A = +25^\circ\text{C}$, $V_{CC} = 3.3\text{V}$, $GND=ODWN = 0\text{V}$ (Continued)

Parameter	Conditions	Min.	Typ.	Max.	Units
Output Amplitude Control Voltage (VAC)		0.65	1.5	1.8	V
Output Amplitude	Single-Ended, peak-to-peak @ 10 GHz	490		648	mVp-p
	Single-Ended, peak-to-peak @ 16 GHz	420		520	mVp-p
	Single-Ended, peak-to-peak @ 22 GHz	320		424	mVp-p
Input Amplitude Range	Differential	200		1200	mVp-p
	Single-Ended	100		600	mVp-p
Harmonic Suppression* (f_{in} is fundamental frequency)	VDCP=VDCN=3.3 V @ 22 GHz ($f_{in}-f_{in}/2$)	26		48	dBc
	VDCP=VDCN=3.3 V @ 8 GHz ($f_{in}-3f_{in}/2$)	28		62	dBc
	VDCP=VDCN=3.3 V @ 16 GHz ($f_{in}-2f_{in}$)	30	32	36	dBc
Input Return Loss	frequency < 23 GHz		12		dB
Output Return Loss	frequency < 23 GHz		6		dB
RMS Jitter	@ 16 GHz		0.45		ps
Rise Time, t_r	@ 16 GHz		10		ps
Fall Time, t_f	@ 16 GHz		11		ps
Time Delay Temperature Sensitivity	@ 16 GHz		0.05		deg/ $^\circ\text{C}$
Propagation Delay, t_d	VDCP=2.7V, VDCN=3.3V @ 16GHz (Relative to zero phase shift)		140		ps

* Harmonic suppression measurements are taken for single-ended inputs and outputs.

Time Delay vs. Frequency [1][2][3]

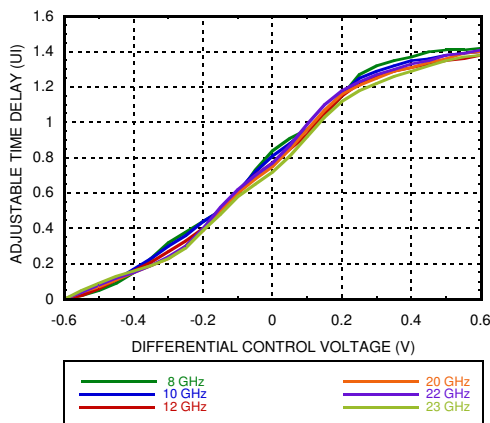

Time Delay vs. Bias Voltage [2][3][4]

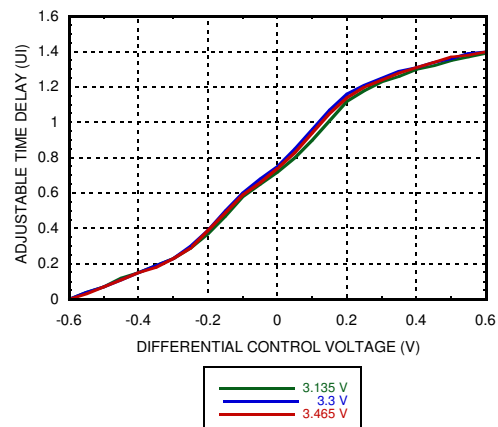

[1] VCC = 3.3V

[2] ODWN= 0 V, VDCN=VCC

[3] On the x-axis differential control voltage represents VDCP-VDCN voltage

[4] Input Frequency: 20 GHz



**BROADBAND TIME DELAY & PHASE SHIFTER
SMT, 8 - 23 GHz**

BROADBAND TIME DELAY & PHASE SHIFTER - SMT

Time Delay vs. Temperature ^{[1][2][3][4]}

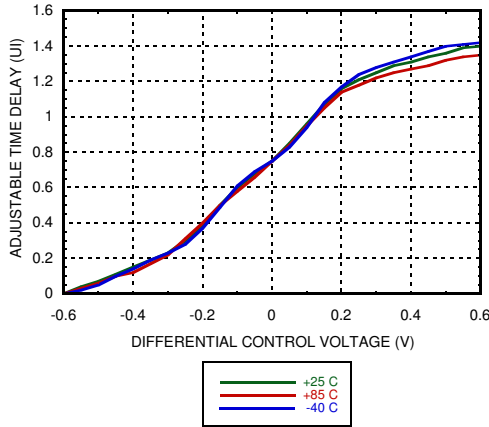

Time Delay vs. Control Voltage
@ $V_{DCP}=2.7V$ to $3.9V$ with $0.1V$ step ^{[1][2]}

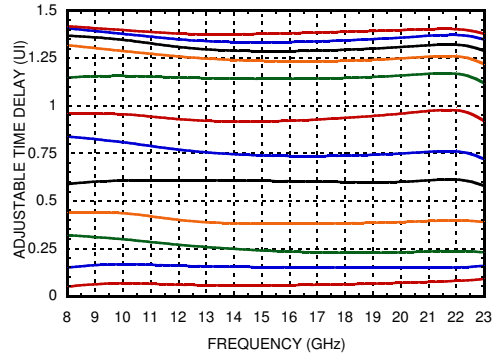

Time Delay vs. Temperature @ $V_{DCP}=3.3V$
(Relative to $V_{DCP}=V_{CC}-0.6V$) ^{[1][2][6]}

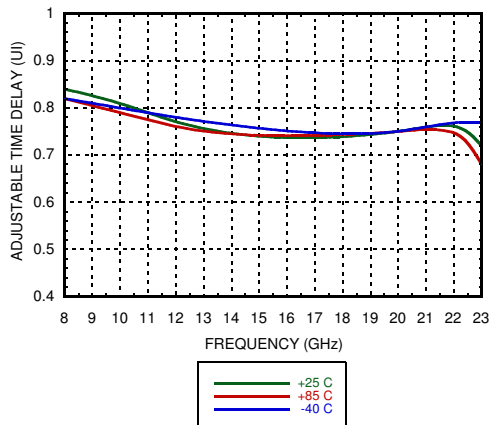

Phase Shift vs. Frequency ^{[1][2][3]}

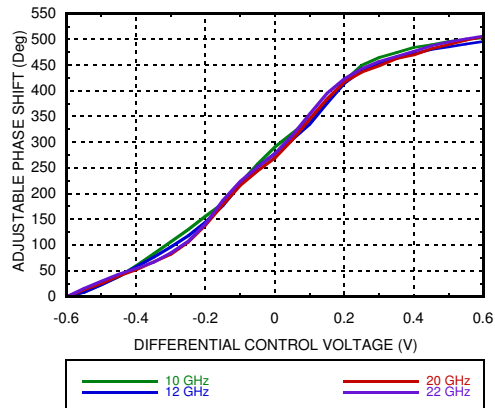

Phase Shift vs. Bias Voltage ^{[2][3][4]}

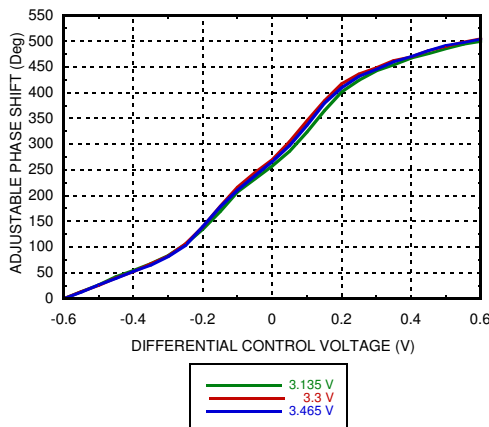

Phase Shift vs. Temperature ^{[1][2][3][4]}

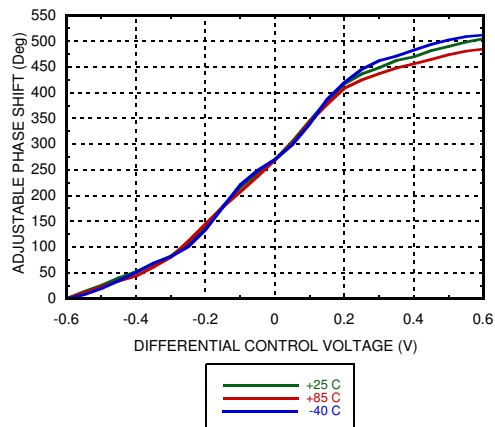

[1] $V_{CC} = 3.3V$

[2] $ODWN = 0 V, V_{DCN} = V_{CC}$

[3] On the x-axis differential control voltage represents $V_{DCP} - V_{DCN}$ voltage

[4] Input Frequency: 20 GHz

Information furnished by Analog Devices is believed to be accurate and reliable. However, no responsibility is assumed by Analog Devices for its use, nor for any infringements of patents or other rights of third parties that may result from its use. Specifications subject to change without notice. No license is granted by implication or otherwise under any patent or patent rights of Analog Devices. Trademarks and registered trademarks are the property of their respective owners.

For price, delivery, and to place orders: Analog Devices, Inc., One Technology Way, P.O. Box 9106, Norwood, MA 02062-9106
Phone: 781-329-4700 • Order online at www.analog.com
Application Support: Phone: 1-800-ANALOG-D

**BROADBAND TIME DELAY & PHASE SHIFTER
SMT, 8 - 23 GHz**



Phase Shift vs. Control Voltage
@ $V_{DCP}=2.7V$ to $3.9V$ with $0.1V$ step [1][2][3]

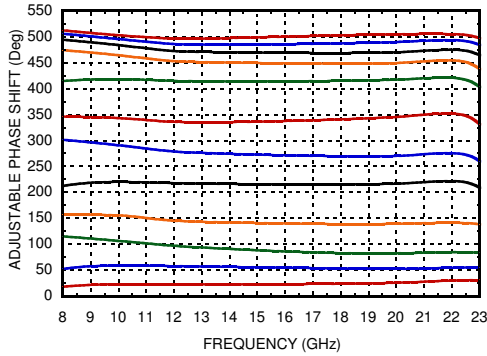

Phase Shift vs. Temperature @ $V_{DCP}=3.3V$
(Relative to $V_{DCP}=V_{CC}-0.6V$) [1][2]

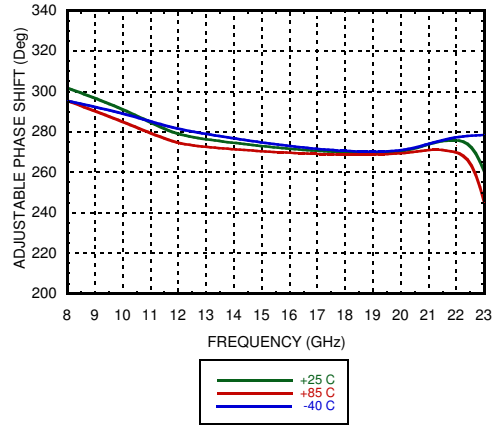

Phase Error vs. Control Voltage
@ $F_{mean}=16$ GHz [1][2][3][4]

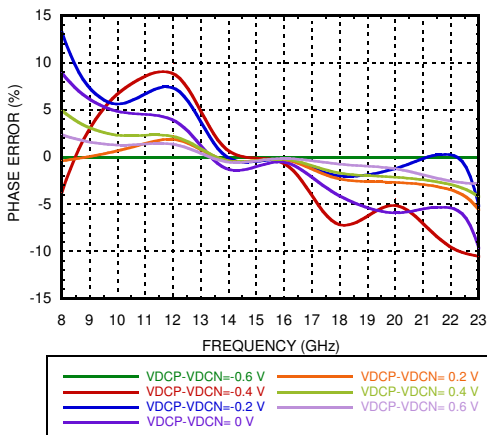

Phase Shift vs. Control Voltage
@ 10 GHz [1][2][3][4]

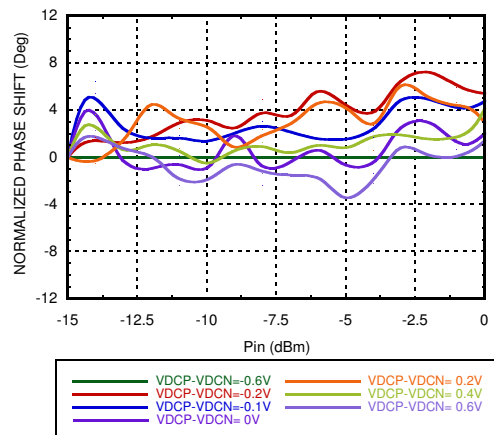

Phase Shift vs. Control Voltage
@ 22 GHz [1][2][3][4]

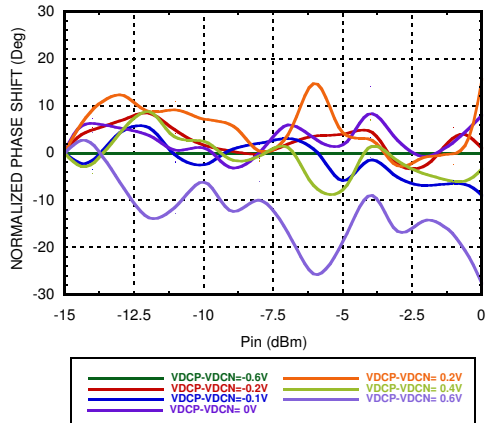

DC Current vs. Temperature [2][5]

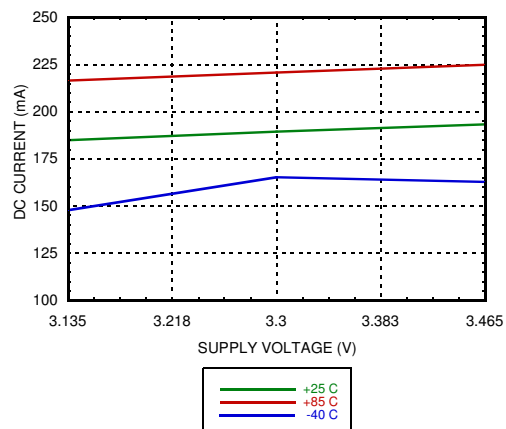

[1] $V_{CC} = 3.3V$ [2] $ODWN = 0V$, $V_{DCN} = V_{CC}$
[4] $V_{DCP} - V_{DCN} = -0.6V$ is taken as reference level

[3] $25^{\circ}C$
[5] $V_{DCP} = 3.3V$ and input frequency is 20 GHz

**BROADBAND TIME DELAY & PHASE SHIFTER
SMT, 8 - 23 GHz**



Single-Ended Output Swing vs. Supply Voltage [1][2][3]

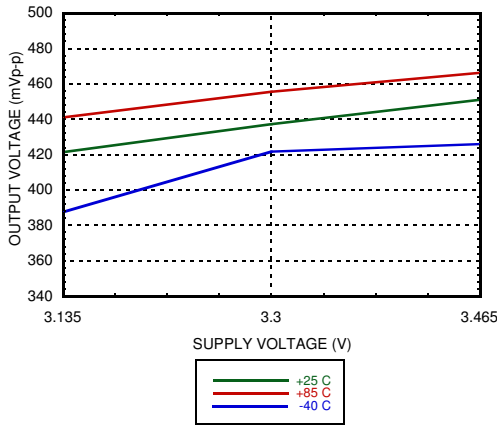

Single-Ended Output Swing vs. Frequency [1][3][4]

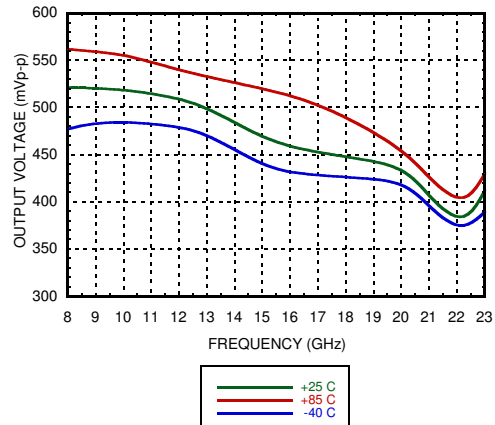

Single-Ended Output Swing vs. Control Voltage [1][4][5]

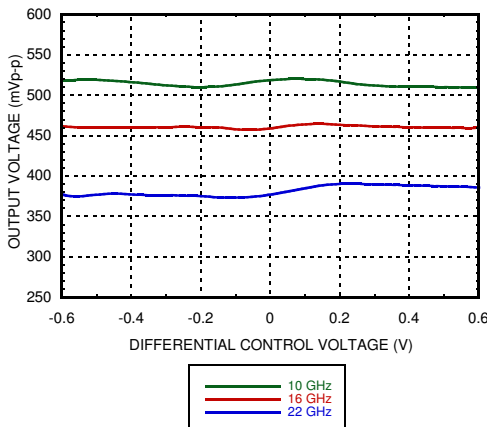

Duty Cycle Distortion @ 16 GHz [1][4][5]

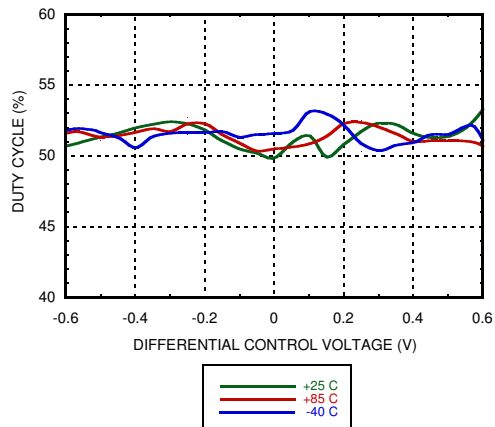

Single-Ended Output Swing vs. Amplitude Control Voltage [1][3][4][6]

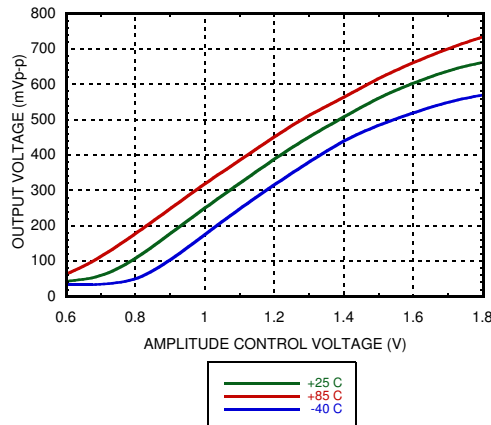

[1] ODWN= 0V, VDCN=VCC

[2] Input Frequency: 20 GHz

[3] VDCP=3.3V

[4] VCC=3.3V

[5] On the x-axis differential control voltage represents VDCP-VDCN voltage

[6] The input frequency is 10 GHz

Information furnished by Analog Devices is believed to be accurate and reliable. However, no responsibility is assumed by Analog Devices for its use, nor for any infringements of patents or other rights of third parties that may result from its use. Specifications subject to change without notice. No license is granted by implication or otherwise under any patent or patent rights of Analog Devices. Trademarks and registered trademarks are the property of their respective owners.

For price, delivery, and to place orders: Analog Devices, Inc., One Technology Way, P.O. Box 9106, Norwood, MA 02062-9106
Phone: 781-329-4700 • Order online at www.analog.com
Application Support: Phone: 1-800-ANALOG-D

**BROADBAND TIME DELAY & PHASE SHIFTER
SMT, 8 - 23 GHz**



Rise Time vs. Temperature @ 16 GHz [1][2][3]

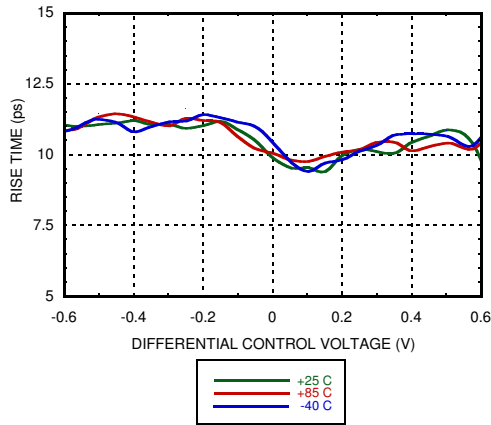

Fall Time vs. Temperature @ 16 GHz [1][2][3]

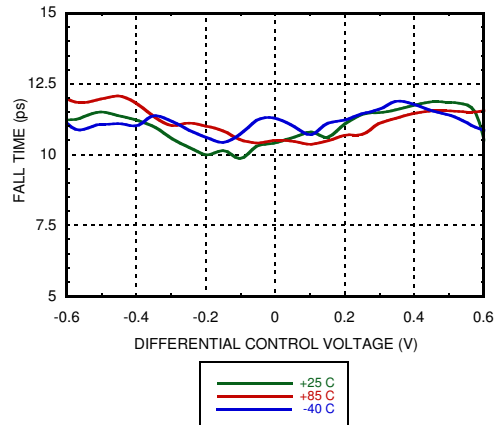

RMS Jitter vs. Temperature @ 16 GHz [1][2][3][4]

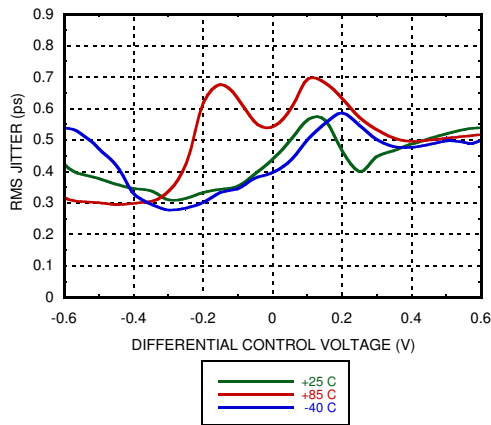

RMS Jitter vs. Bias Voltage @ 16 GHz [1][3][4]

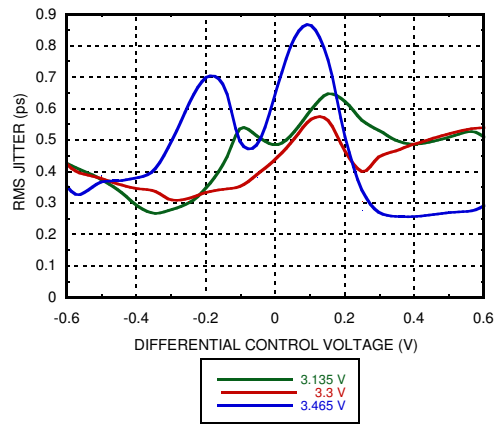

$P_{fin} - P_{fin/2}$ Output Power Difference vs. Control Voltage [1][2][5]

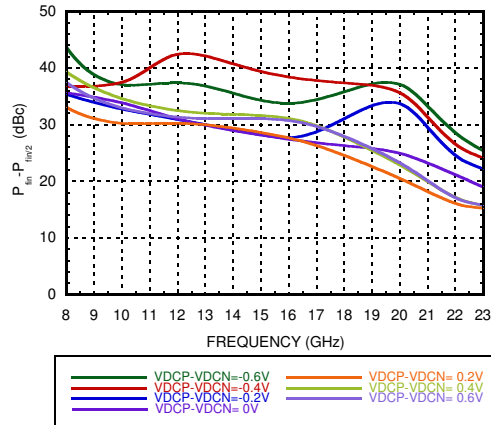

$P_{fin} - P_{3fin/2}$ Output Power Difference vs. Control Voltage [1][2][5]

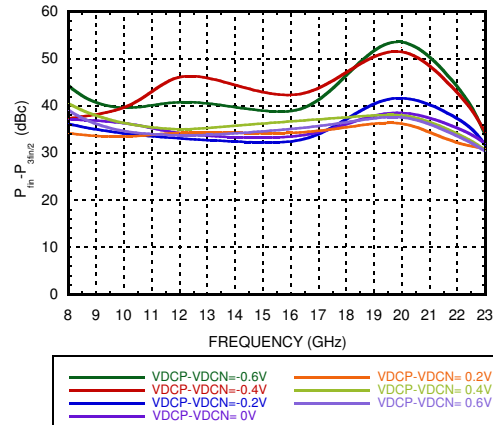

[1] ODWN= 0V, VDCN=VCC

[2] VCC=3.3V

[3] On the x-axis differential control voltage represents VDCP-VDCN voltage

[4] Source jitter was not deembedded

[5] fin is the fundamental frequency



**BROADBAND TIME DELAY & PHASE SHIFTER
SMT, 8 - 23 GHz**

Second Harmonic vs. Control Voltage [1][2]

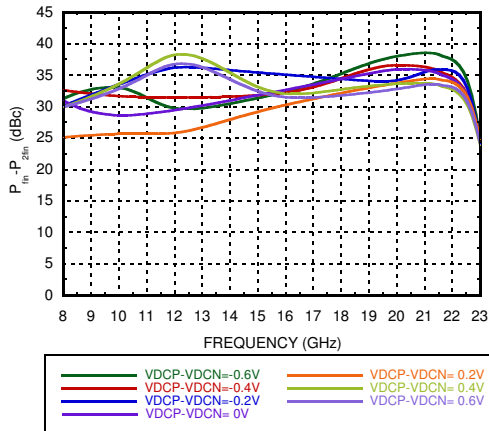

Modulation Signal Bandwidth vs. Temperature [1][3]

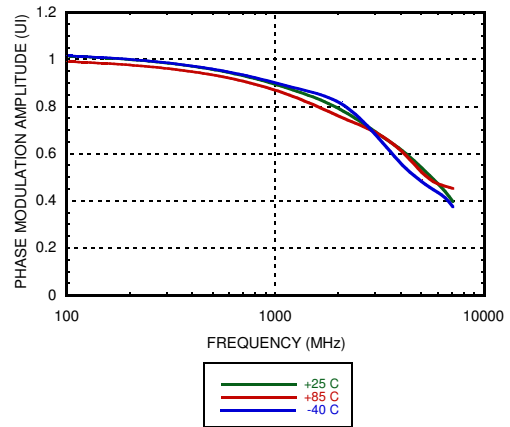

Input Return Loss vs. Frequency [1][4]

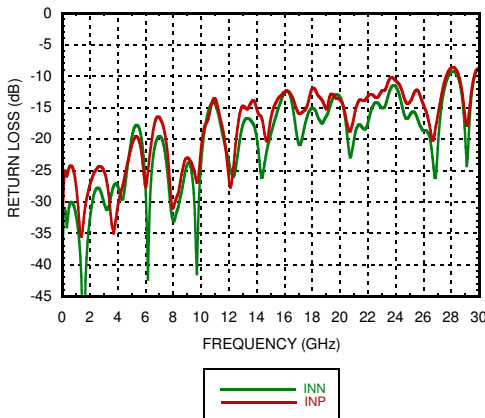

Output Return Loss vs. Frequency [1][4]

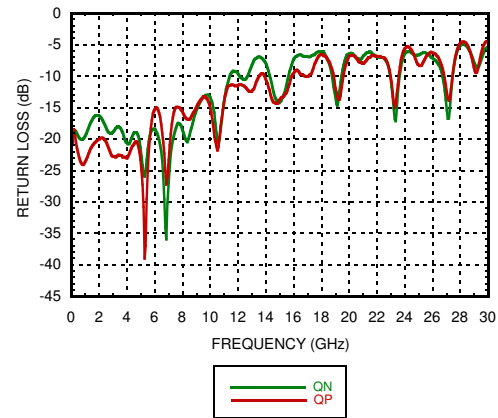

[1] VCC= 3.3 V, ODWN=0V

[2] fin is the fundamental frequency

[3] -6.8 dBm input power was applied to VDCP, VDCN is 50 Ohms terminated and fin=15 GHz

[4] VDCP=VDCN=VCC

Information furnished by Analog Devices is believed to be accurate and reliable. However, no responsibility is assumed by Analog Devices for its use, nor for any infringements of patents or other rights of third parties that may result from its use. Specifications subject to change without notice. No license is granted by implication or otherwise under any patent or patent rights of Analog Devices. Trademarks and registered trademarks are the property of their respective owners.

For price, delivery, and to place orders: Analog Devices, Inc., One Technology Way, P.O. Box 9106, Norwood, MA 02062-9106
Phone: 781-329-4700 • Order online at www.analog.com
Application Support: Phone: 1-800-ANALOG-D

**BROADBAND TIME DELAY & PHASE SHIFTER
SMT, 8 - 23 GHz**



Output Eye Diagram Snapshot for 15 GHz Input Signal

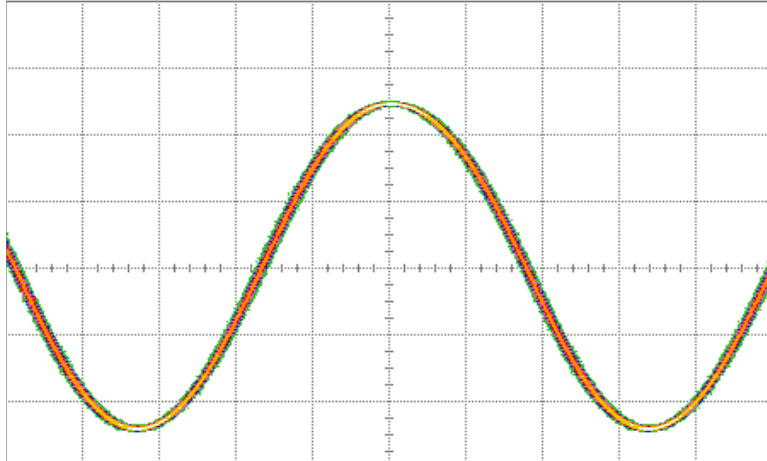

Time Scale: 10 ps/div
Amplitude Scale: 81.8 mV/div

Test Conditions:
VCC=3.3 V, ODWN=0 V
VDCP = 300 mVpp @ 1 MHz
VDCN is 50 Ohms terminated

Measurement Results:
RMS Jitter: 0.3 ps
Peak to peak Jitter: 1.78 ps
Rise Time: 11.78 ps
Fall Time: 11.78 ps

Output Eye Diagram Continuous Snapshot for 15 GHz Input Signal

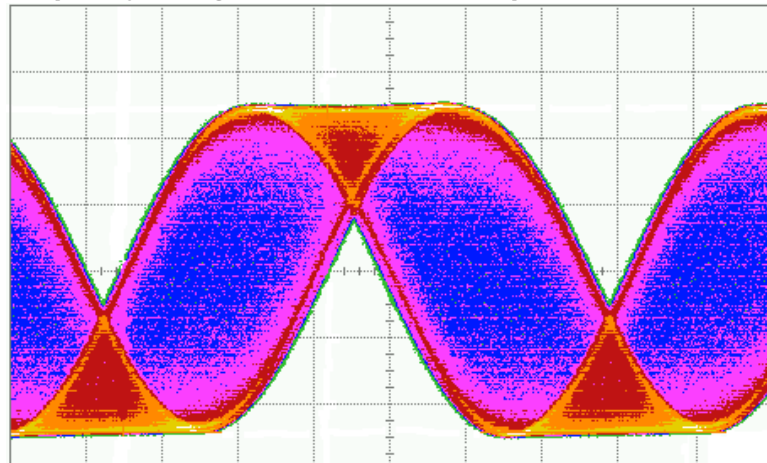

Time Scale: 10 ps/div
Amplitude Scale: 81.8 mV/div

Test Conditions:
VCC=3.3 V, ODWN=0 V
VDCP = 300 mVpp @ 1 MHz
VDCN is 50 Ohms terminated

Measurement Result:
26.8 ps (0.4 UI)

**BROADBAND TIME DELAY & PHASE SHIFTER
SMT, 8 - 23 GHz**

Absolute Maximum Ratings

Power Supply Voltage (Vcc)	-0.5V to +3.75V
Input Voltage (V _{IN}), Output Voltage (V _{OUT})	Vcc -1.2V to Vcc+0.6V
Control Voltage (V _{DCP}), Delay Control Voltage Range Adjustment (L _C), Amplitude Control Voltage (V _{AC})	0 to Vcc+0.6V
Channel Temperature (Tc)	125 °C
Continuous P _{diss} (T = 85 °C) (derate 35.8 mW/°C above 85 °C)	1.43 W
Thermal Resistance (junction to ground paddle)	27.9 °C/W
Storage Temperature	-65 to +125 °C
Operating Temperature	-40 to +85°C
ESD Sensitivity (HBM)	Class 1A

**ELECTROSTATIC SENSITIVE DEVICE
OBSERVE HANDLING PRECAUTIONS**

BROADBAND TIME DELAY & PHASE SHIFTER SMT, 8 - 23 GHz



Outline Drawing

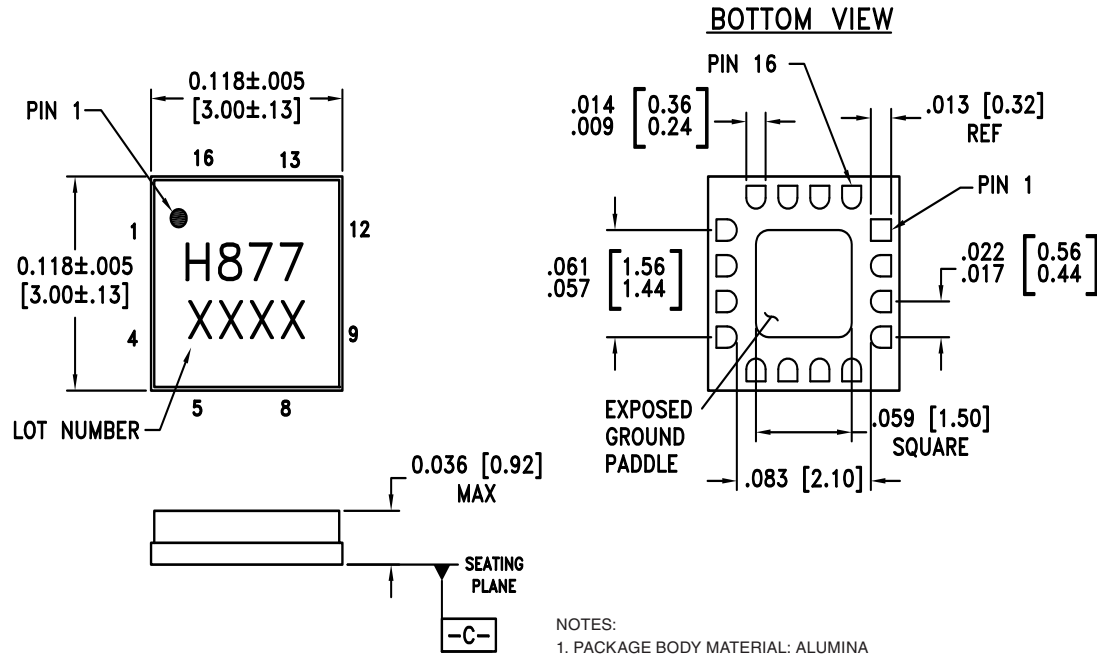

NOTES:

1. PACKAGE BODY MATERIAL: ALUMINA
2. LEAD AND GROUND PADDLE PLATING: 30-80 MICROINCHES GOLD OVER 50 MICROINCHES MINIMUM NICKEL.
3. DIMENSIONS ARE IN INCHES [MILLIMETERS].
4. LEAD SPACING TOLERANCE IS NON-CUMULATIVE.
5. CHARACTERS TO BE BLACK INK MARKED WITH .018"MIN TO .030"MAX HEIGHT REQUIREMENTS. UTILIZE MAXIMUM CHARACTER HEIGHT BASED ON LID DIMENSIONS AND BEST FIT. LOCATE APPROX. AS SHOWN.
6. PACKAGE WARP SHALL NOT EXCEED 0.05mm DATUM -C-
7. ALL GROUND LEADS AND GROUND PADDLE MUST BE SOLDERED TO PCB RF GROUND.

Package Information

Part Number	Package Body Material	Lead Finish	MSL Rating	Package Marking ^[2]
HMC877LC3	Alumina, White	Gold over Nickel	MSL3 ^[1]	H877 XXXX

[1] Max peak reflow temperature of 260 °C

[2] 4-Digit lot number XXXX

BROADBAND TIME DELAY & PHASE SHIFTER SMT, 8 - 23 GHz



Pin Descriptions

Pin Number	Function	Description	Interface Schematic
1, 4-5, 8-9,12	GND	Signal grounds should be connected to 0V. Ground paddle must be connected to DC ground	
2, 3, 6, 7	INP INN VDCP VDCN	Differential signal inputs.	
10, 11	QN QP	Differential signal outputs.	
13	VAC	The output amplitude control pin.	
14	ODWN	Enable pin of the output. It should be connected to GND to enable the part. When it is connected to VCC or floated the output is set to VCC.	
15	VCC	The supply voltage of the part.	

BROADBAND TIME DELAY & PHASE SHIFTER
SMT, 8 - 23 GHz



Pin Descriptions (Continued)

Pin Number	Function	Description	Interface Schematic
16	LC	This pin enables the control of the linearity level of Control Voltage vs. Phase Shift/Time Delay. Compromise is between linearity level and wideness of the Phase Shift/Time Delay tuning range. For optimum tuning range and linearity balance, R2=R3 are chosen as 4.7 kOhms.	

Application Circuit

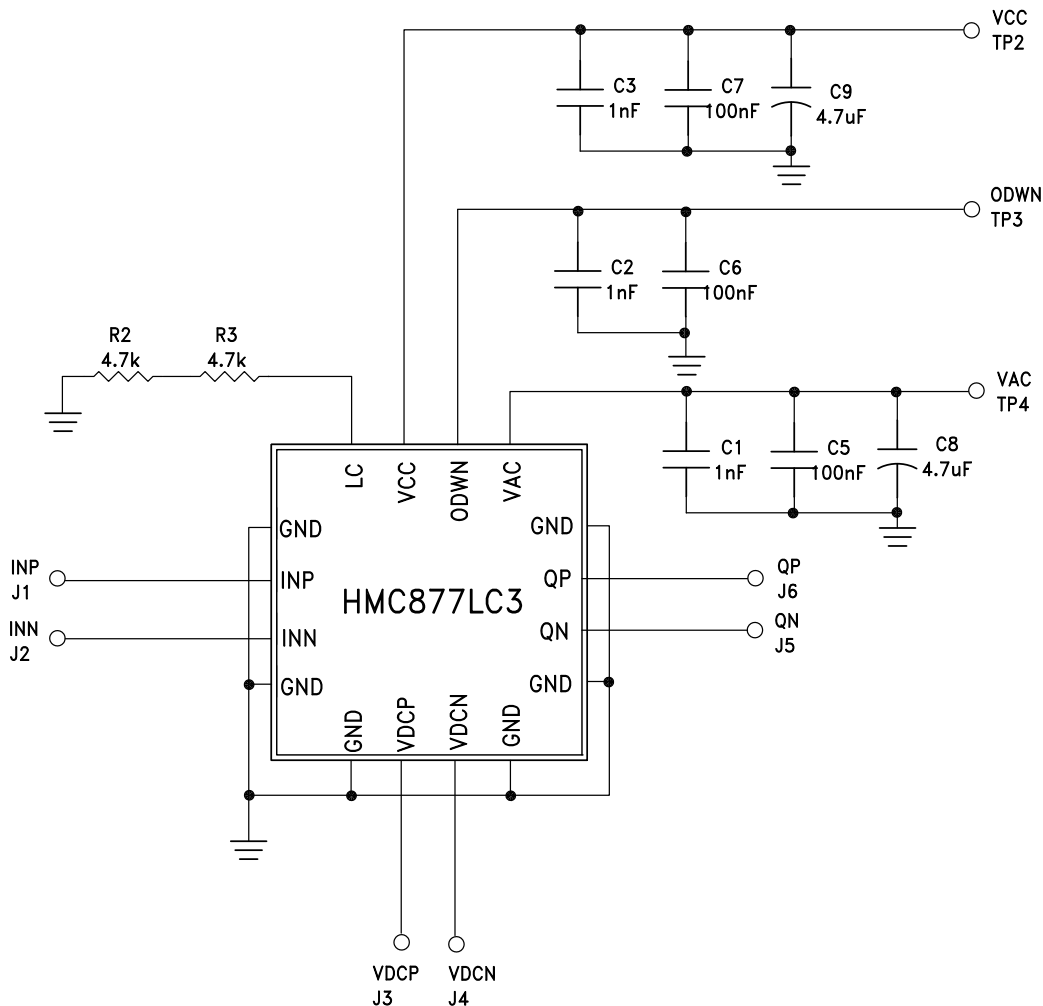

Information furnished by Analog Devices is believed to be accurate and reliable. However, no responsibility is assumed by Analog Devices for its use, nor for any infringements of patents or other rights of third parties that may result from its use. Specifications subject to change without notice. No license is granted by implication or otherwise under any patent or patent rights of Analog Devices. Trademarks and registered trademarks are the property of their respective owners.

For price, delivery, and to place orders: Analog Devices, Inc., One Technology Way, P.O. Box 9106, Norwood, MA 02062-9106 Phone: 781-329-4700 • Order online at www.analog.com Application Support: Phone: 1-800-ANALOG-D

**BROADBAND TIME DELAY & PHASE SHIFTER
SMT, 8 - 23 GHz**



Evaluation PCB

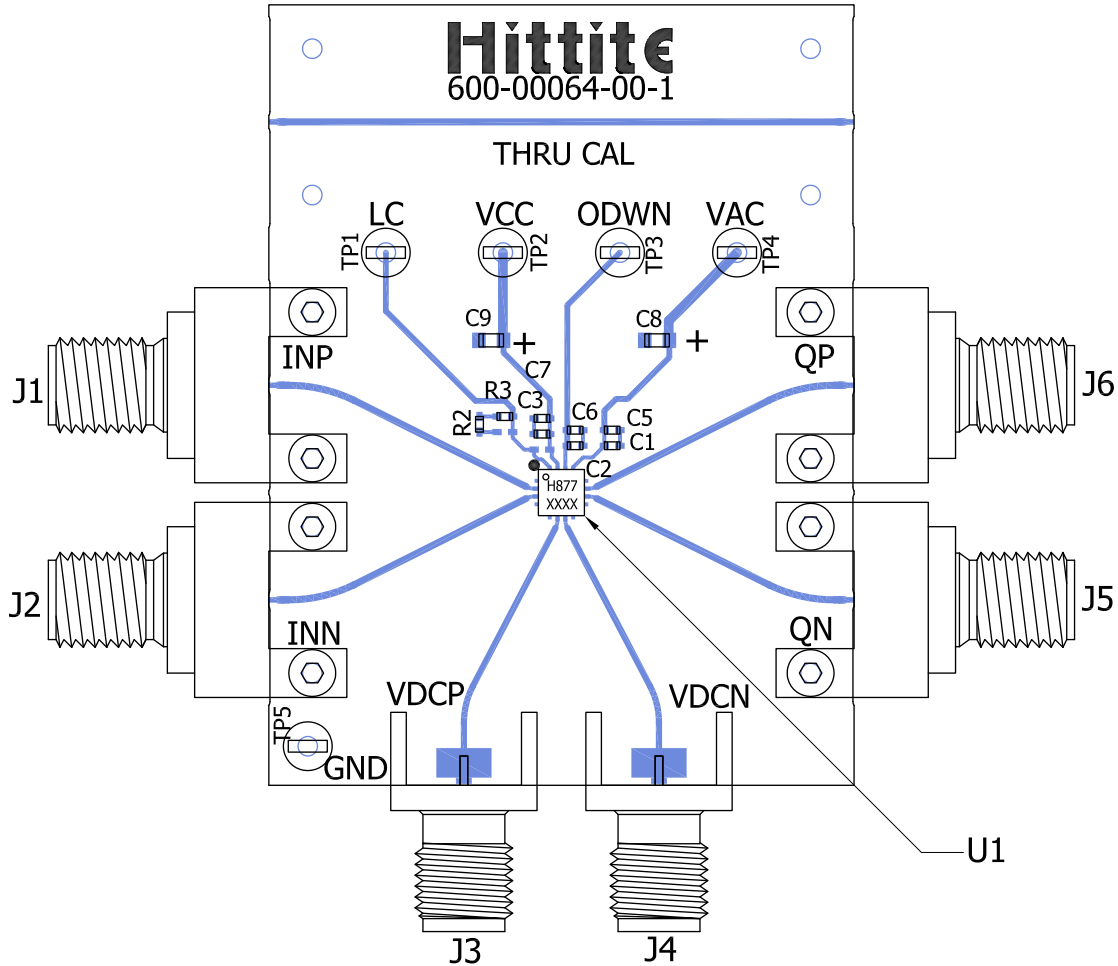

List of Materials for Evaluation PCB EVAL01-HMC877LC3^[1]

Item	Description
J1 - J2, J5-J6	K Connector
J3-J4	SMA Connector
TP1-TP5	DC Pin
C1-C3	1000 pF Capacitor, 0402 Pkg.
C5-C7	0.1 μF Capacitor, 0402 Pkg.
C8-C9	4.7 μF Capacitor, Tantalum
R2-R3	4.7 kOhm Resistor, 0402 Pkg.
U1	HMC877LC3 Analog Phase Shifter/ Broadband Time Delay
PCB [2]	600-00064-00 Evaluation Board

[1] Reference this number when ordering complete evaluation PCB

[2] Circuit Board Material: Rogers 4350 or Arlon 25 FR

The circuit board used in the application should use RF circuit design techniques. Signal lines should have 50 Ohm impedance while the package ground leads and exposed paddle should be connected directly to the ground plane similar to that shown. A sufficient number of via holes should be used to connect the top and bottom ground planes. The evaluation board should be mounted to an appropriate heat sink. The evaluation circuit board shown is available from Hittite upon request.



v03.0614

HMC877LC3**BROADBAND TIME DELAY & PHASE SHIFTER
SMT, 8 - 23 GHz**