

# NVMFS5C638NL

## MOSFET – Power, Single N-Channel 60 V, 3.0 mΩ, 133 A



ON Semiconductor®

[www.onsemi.com](http://www.onsemi.com)

### Features

- Small Footprint (5x6 mm) for Compact Design
- Low  $R_{DS(on)}$  to Minimize Conduction Losses
- Low  $Q_G$  and Capacitance to Minimize Driver Losses
- NVMFS5C638NLWF – Wettable Flank Option for Enhanced Optical Inspection
- AEC-Q101 Qualified and PPAP Capable
- These Devices are Pb-Free and are RoHS Compliant

| $V_{(BR)DSS}$ | $R_{DS(ON)} MAX$ | $I_D MAX$ |
|---------------|------------------|-----------|
| 60 V          | 3.0 mΩ @ 10 V    | 133 A     |
|               | 4.2 mΩ @ 4.5 V   |           |

### MAXIMUM RATINGS ( $T_J = 25^\circ C$ unless otherwise noted)

| Parameter  |                                    | Symbol              | Value       | Unit       |   |
|--|------------------------------------|---------------------|-------------|------------|---|
| Drain-to-Source Voltage  |                                    | $V_{DSS}$           | 60          | V          |   |
| Gate-to-Source Voltage   |                                    | $V_{GS}$            | $\pm 20$    | V          |   |
| Continuous Drain Current $R_{\theta JC}$ (Notes 1, 3)                | Steady State                       | $T_C = 25^\circ C$  | $I_D$       | 133        | A |
|  |                                    | $T_C = 100^\circ C$ |             | 94         |   |
| Power Dissipation $R_{\theta JC}$ (Note 1)                           | Steady State                       | $T_C = 25^\circ C$  | $P_D$       | 100        | W |
|  |                                    | $T_C = 100^\circ C$ |             | 50         |   |
| Continuous Drain Current $R_{\theta JA}$ (Notes 1, 2, 3)             | Steady State                       | $T_A = 25^\circ C$  | $I_D$       | 26         | A |
|  |                                    | $T_A = 100^\circ C$ |             | 18         |   |
| Power Dissipation $R_{\theta JA}$ (Notes 1 & 2)                      | Steady State                       | $T_A = 25^\circ C$  | $P_D$       | 4          | W |
|  |                                    | $T_A = 100^\circ C$ |             | 2          |   |
| Pulsed Drain Current   | $T_A = 25^\circ C, t_p = 10 \mu s$ | $I_{DM}$            | 811         | A          |   |
| Operating Junction and Storage Temperature                           |                                    | $T_J, T_{stg}$      | -55 to +175 | $^\circ C$ |   |
| Source Current (Body Diode)  |                                    | $I_S$               | 84          | A          |   |
| Single Pulse Drain-to-Source Avalanche Energy ( $I_{L(pk)} = 13 A$ ) |                                    | $E_{AS}$            | 180         | mJ         |   |
| Lead Temperature for Soldering Purposes (1/8" from case for 10 s)    |                                    | $T_L$               | 260         | $^\circ C$ |   |

Stresses exceeding those listed in the Maximum Ratings table may damage the device. If any of these limits are exceeded, device functionality should not be assumed, damage may occur and reliability may be affected.

### THERMAL RESISTANCE MAXIMUM RATINGS

| Parameter                                   | Symbol          | Value | Unit         |
|---|-----------------|-------|--------------|
| Junction-to-Case – Steady State             | $R_{\theta JC}$ | 1.5   | $^\circ C/W$ |
| Junction-to-Ambient – Steady State (Note 2) | $R_{\theta JA}$ | 40.1  |              |

1. The entire application environment impacts the thermal resistance values shown, they are not constants and are only valid for the particular conditions noted.
2. Surface-mounted on FR4 board using a 650 mm<sup>2</sup>, 2 oz. Cu pad.
3. Maximum current for pulses as long as 1 second is higher but is dependent on pulse duration and duty cycle.

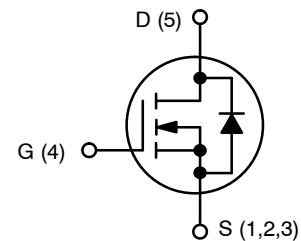

N-CHANNEL MOSFET

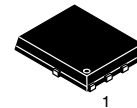

DFN5 (SO-8FL)  
CASE 488AA  
STYLE 1

### MARKING DIAGRAM

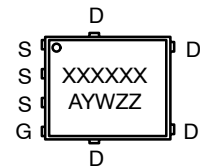

XXXXXX = 5C638L  
(NVMFS5C638NL) or  
638LWF  
(NVMFS5C638NLWF)

A = Assembly Location  
Y = Year  
W = Work Week  
ZZ = Lot Traceability

### ORDERING INFORMATION

See detailed ordering, marking and shipping information on page 5 of this data sheet.

# NVMFS5C638NL

## ELECTRICAL CHARACTERISTICS ( $T_J = 25^\circ\text{C}$ unless otherwise specified)

| Parameter   | Symbol            | Test Condition                                | Min                        | Typ | Max | Unit          |
|---|-------------------|---|----------------------------|-----|-----|---------------|
| <b>OFF CHARACTERISTICS</b>                                |                   |   |                            |     |     |               |
| Drain-to-Source Breakdown Voltage                         | $V_{(BR)DSS}$     | $V_{GS} = 0\text{ V}, I_D = 250\ \mu\text{A}$ | 60                         |     |     | V             |
| Drain-to-Source Breakdown Voltage Temperature Coefficient | $V_{(BR)DSS}/T_J$ |   |                            | 26  |     | mV/°C         |
| Zero Gate Voltage Drain Current                           | $I_{DSS}$         | $V_{GS} = 0\text{ V}, V_{DS} = 60\text{ V}$   | $T_J = 25\ ^\circ\text{C}$ |     | 10  | $\mu\text{A}$ |
|   |                   |   | $T_J = 125^\circ\text{C}$  |     | 250 |               |
| Gate-to-Source Leakage Current                            | $I_{GSS}$         | $V_{DS} = 0\text{ V}, V_{GS} = 20\text{ V}$   |                            |     | 100 | nA            |

## ON CHARACTERISTICS (Note 4)

|                                   |                  |  |     |      |     |            |
|-----------------------------------|------------------|--|-----|------|-----|------------|
| Gate Threshold Voltage            | $V_{GS(TH)}$     | $V_{GS} = V_{DS}, I_D = 250\ \mu\text{A}$  | 1.2 |      | 2.0 | V          |
| Threshold Temperature Coefficient | $V_{GS(TH)}/T_J$ |  |     | -5.0 |     | mV/°C      |
| Drain-to-Source On Resistance     | $R_{DS(on)}$     | $V_{GS} = 10\text{ V}, I_D = 50\text{ A}$  |     | 2.6  | 3.0 | m $\Omega$ |
|                                   |                  | $V_{GS} = 4.5\text{ V}, I_D = 50\text{ A}$ |     | 3.6  | 4.2 |            |
| Forward Transconductance          | $g_{FS}$         | $V_{DS} = 15\text{ V}, I_D = 50\text{ A}$  |     | 130  |     | S          |

## CHARGES AND CAPACITANCES

|                              |              |  |  |      |  |    |
|------------------------------|--------------|--|--|------|--|----|
| Input Capacitance            | $C_{ISS}$    | $V_{GS} = 0\text{ V}, f = 1\text{ MHz}, V_{DS} = 25\text{ V}$    |  | 2880 |  | pF |
| Output Capacitance           | $C_{OSS}$    |  |  | 1680 |  |    |
| Reverse Transfer Capacitance | $C_{RSS}$    |  |  | 22   |  |    |
| Total Gate Charge            | $Q_{G(TOT)}$ | $V_{GS} = 4.5\text{ V}, V_{DS} = 48\text{ V}, I_D = 50\text{ A}$ |  | 18.4 |  | nC |
| Total Gate Charge            | $Q_{G(TOT)}$ | $V_{GS} = 10\text{ V}, V_{DS} = 48\text{ V}, I_D = 50\text{ A}$  |  | 40.7 |  | nC |
| Threshold Gate Charge        | $Q_{G(TH)}$  | $V_{GS} = 10\text{ V}, V_{DS} = 48\text{ V}, I_D = 50\text{ A}$  |  | 4.5  |  | nC |
| Gate-to-Source Charge        | $Q_{GS}$     |  |  | 8.6  |  |    |
| Gate-to-Drain Charge         | $Q_{GD}$     |  |  | 3.8  |  |    |
| Plateau Voltage              | $V_{GP}$     |  |  | 3.0  |  |    |

## SWITCHING CHARACTERISTICS (Note 5)

|                     |              |  |  |    |  |    |
|---------------------|--------------|--|--|----|--|----|
| Turn-On Delay Time  | $t_{d(ON)}$  | $V_{GS} = 10\text{ V}, V_{DS} = 48\text{ V}, I_D = 50\text{ A}, R_G = 1\ \Omega$ |  | 15 |  | ns |
| Rise Time           | $t_r$        |  |  | 58 |  |    |
| Turn-Off Delay Time | $t_{d(OFF)}$ |  |  | 66 |  |    |
| Fall Time           | $t_f$        |  |  | 96 |  |    |

## DRAIN-SOURCE DIODE CHARACTERISTICS

|                         |          |  |                           |    |      |     |    |
|-------------------------|----------|--|---------------------------|----|------|-----|----|
| Forward Diode Voltage   | $V_{SD}$ | $V_{GS} = 0\text{ V}, I_S = 50\text{ A}$                                   | $T_J = 25^\circ\text{C}$  |    | 0.84 | 1.2 | V  |
|                         |          |  | $T_J = 125^\circ\text{C}$ |    | 0.73 |     |    |
| Reverse Recovery Time   | $t_{RR}$ | $V_{GS} = 0\text{ V}, di/dt = 100\text{ A}/\mu\text{s}, I_S = 50\text{ A}$ |                           | 42 |      | ns  |    |
| Charge Time             | $t_a$    |  |                           | 21 |      |     |    |
| Discharge Time          | $t_b$    |  |                           | 22 |      |     |    |
| Reverse Recovery Charge | $Q_{RR}$ |  |                           | 28 |      |     | nC |

Product parametric performance is indicated in the Electrical Characteristics for the listed test conditions, unless otherwise noted. Product performance may not be indicated by the Electrical Characteristics if operated under different conditions.

4. Pulse Test: pulse width  $\leq 300\ \mu\text{s}$ , duty cycle  $\leq 2\%$ .

5. Switching characteristics are independent of operating junction temperatures.

TYPICAL CHARACTERISTICS

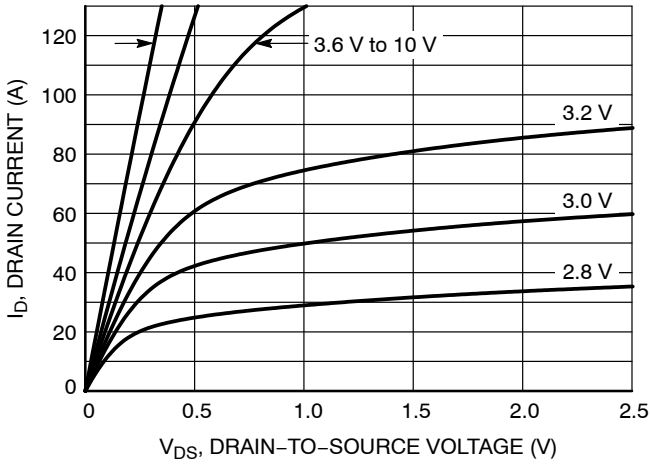

Figure 1. On-Region Characteristics

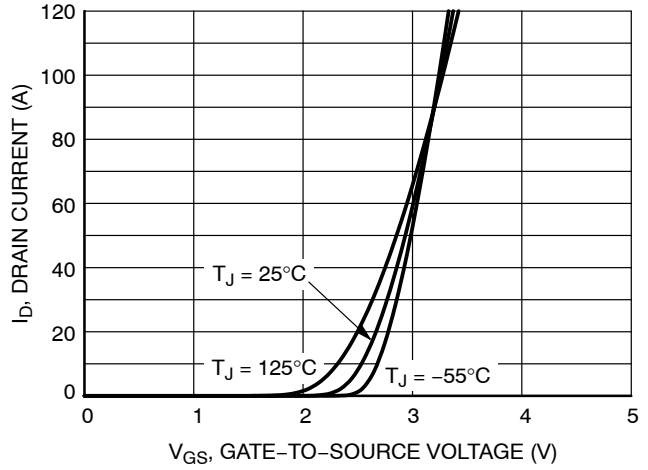

Figure 2. Transfer Characteristics

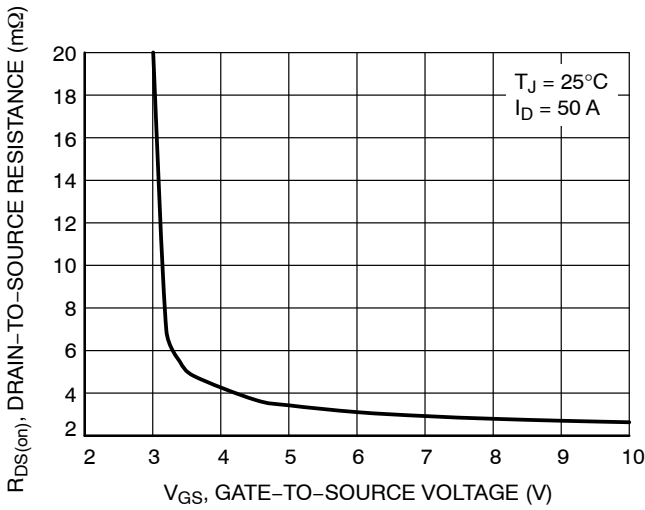

Figure 3. On-Resistance vs. Gate-to-Source Voltage

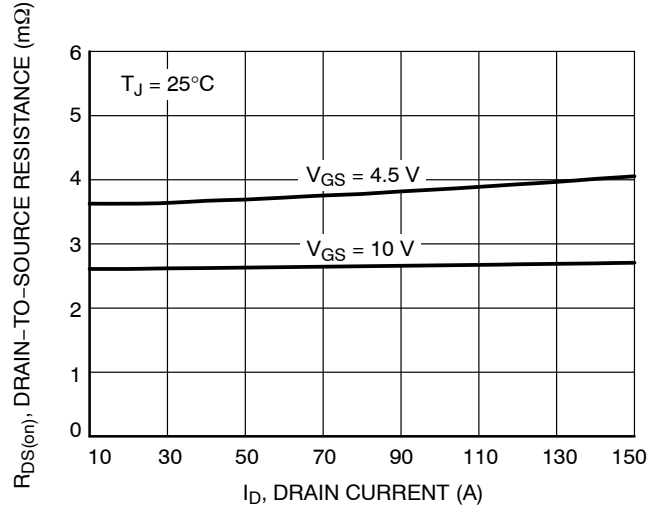

Figure 4. On-Resistance vs. Drain Current and Gate Voltage

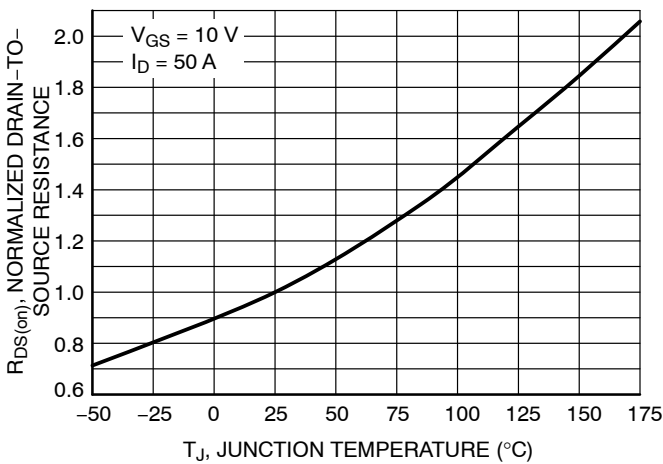

Figure 5. On-Resistance Variation with Temperature

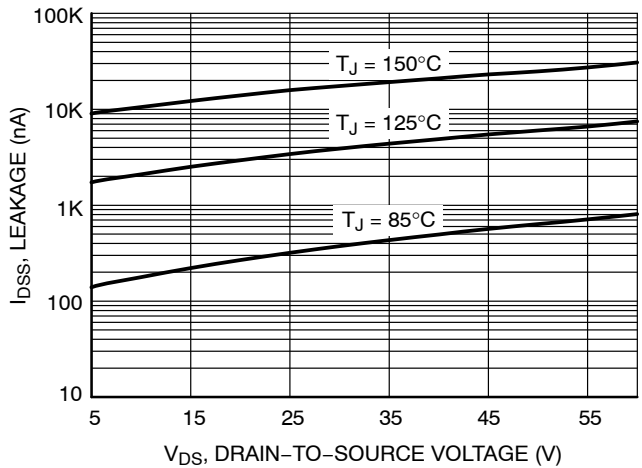
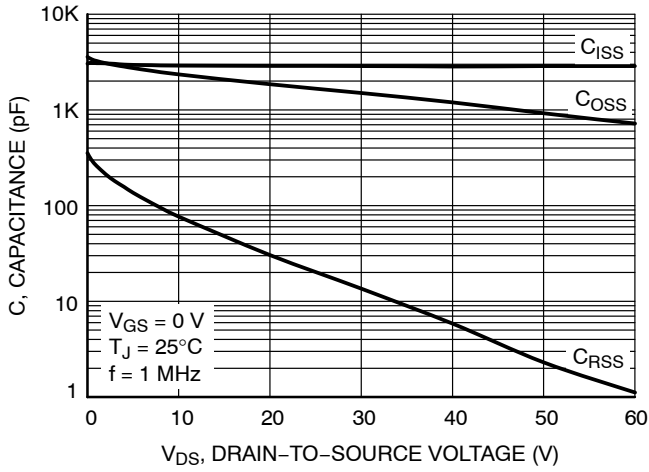

Figure 6. Drain-to-Source Leakage Current vs. Voltage

# NVMFS5C638NL

## TYPICAL CHARACTERISTICS



**Figure 7. Capacitance Variation**

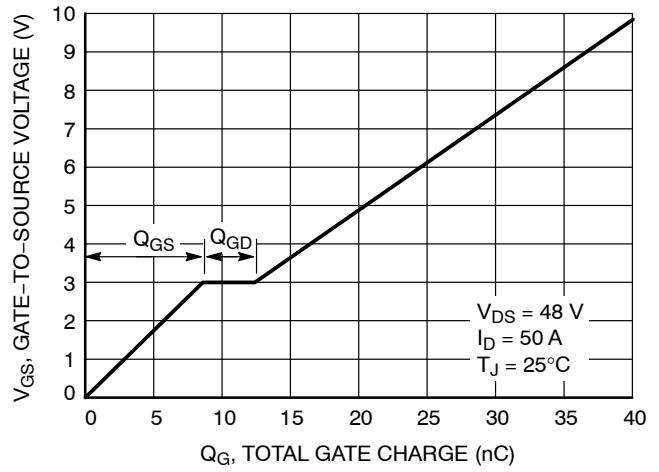

**Figure 8. Gate-to-Source Voltage vs. Total Charge**

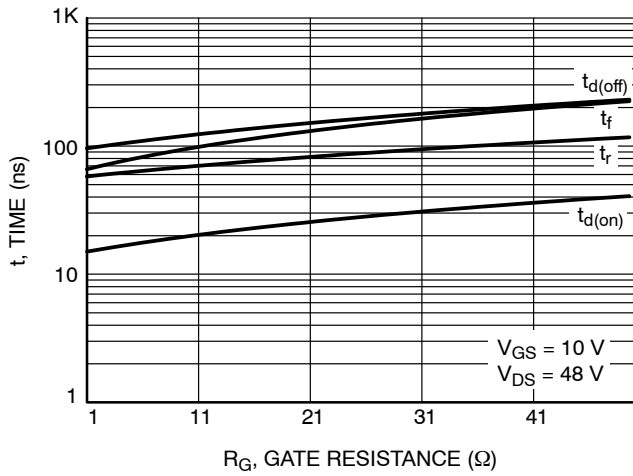

**Figure 9. Resistive Switching Time Variation vs. Gate Resistance**

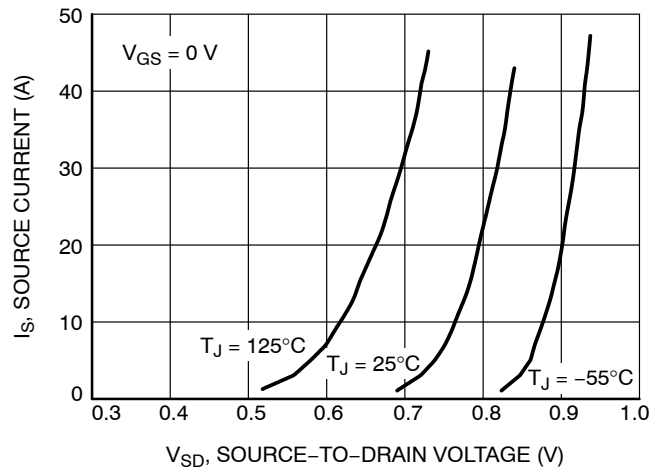

**Figure 10. Diode Forward Voltage vs. Current**

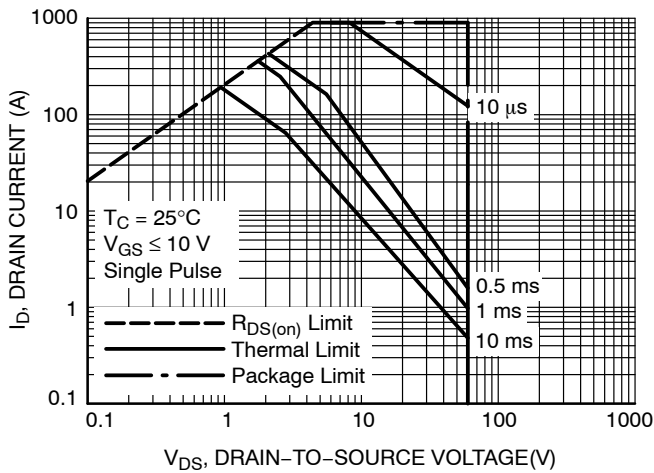

**Figure 11. Maximum Rated Forward Biased Safe Operating Area**

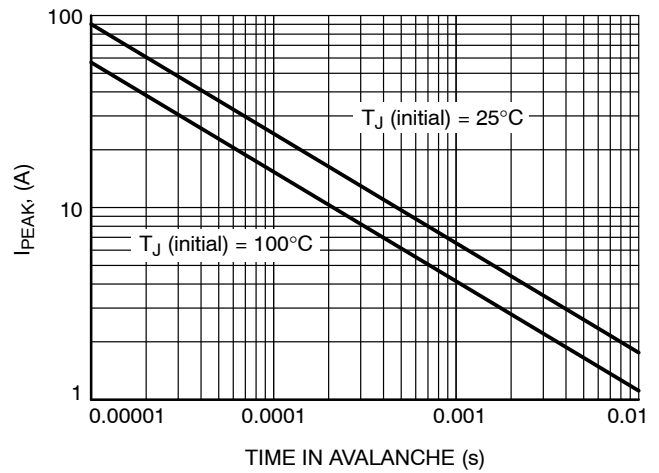

**Figure 12. IPEAK vs. Time in Avalanche**

# NVMFS5C638NL

## TYPICAL CHARACTERISTICS

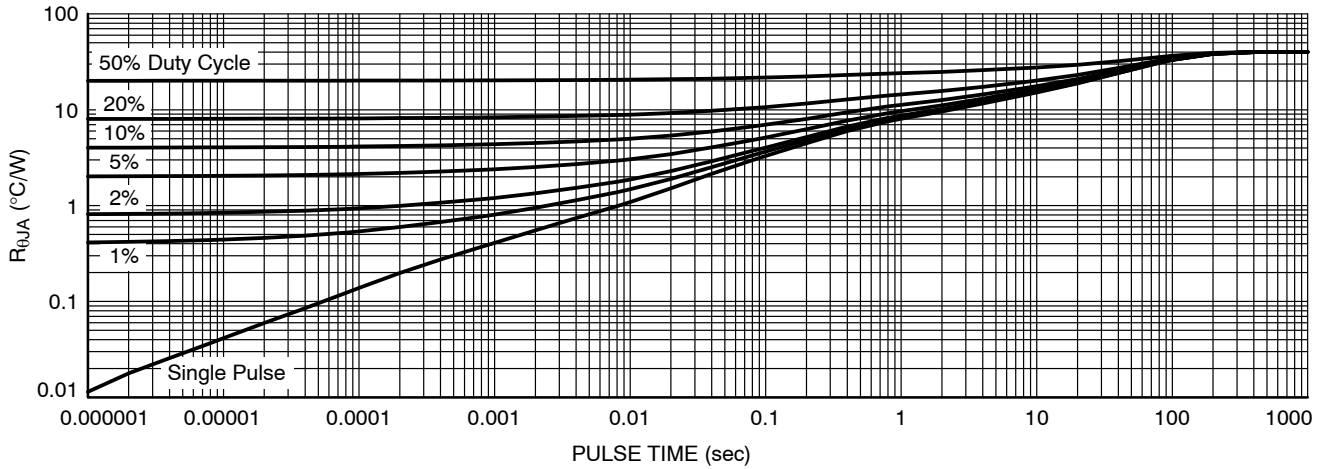

Figure 13. Thermal Characteristics

### DEVICE ORDERING INFORMATION

| Device            | Marking | Package                            | Shipping <sup>†</sup> |
|-------------------|---------|------------------------------------|-----------------------|
| NVMFS5C638NLT1G   | 5C638L  | DFN5<br>(Pb-Free)                  | 1500 / Tape & Reel    |
| NVMFS5C638NLWFT1G | 638LWF  | DFN5<br>(Pb-Free, Wettable Flanks) | 1500 / Tape & Reel    |

<sup>†</sup>For information on tape and reel specifications, including part orientation and tape sizes, please refer to our Tape and Reel Packaging Specifications Brochure, BRD8011/D.

# NVMF5C638NL

## PACKAGE DIMENSIONS

DFN5 5x6, 1.27P  
(SO-8FL)  
CASE 488AA  
ISSUE M

NOTES:

1. DIMENSIONING AND TOLERANCING PER ASME Y14.5M, 1994.
2. CONTROLLING DIMENSION: MILLIMETER.
3. DIMENSION D1 AND E1 DO NOT INCLUDE MOLD FLASH PROTRUSIONS OR GATE BURRS.

| MILLIMETERS |           |       |      |
|-------------|-----------|-------|------|
| DIM         | MIN       | NOM   | MAX  |
| A           | 0.90      | 1.00  | 1.10 |
| A1          | 0.00      | ---   | 0.05 |
| b           | 0.33      | 0.41  | 0.51 |
| c           | 0.23      | 0.28  | 0.33 |
| D           | 5.00      | 5.15  | 5.30 |
| D1          | 4.70      | 4.90  | 5.10 |
| D2          | 3.80      | 4.00  | 4.20 |
| E           | 6.00      | 6.15  | 6.30 |
| E1          | 5.70      | 5.90  | 6.10 |
| E2          | 3.45      | 3.65  | 3.85 |
| e           | 1.27 BSC  |       |      |
| G           | 0.51      | 0.575 | 0.71 |
| K           | 1.20      | 1.35  | 1.50 |
| L           | 0.51      | 0.575 | 0.71 |
| L1          | 0.125 REF |       |      |
| M           | 3.00      | 3.40  | 3.80 |
| θ           | 0°        | ---   | 12°  |

STYLE 1:

1. SOURCE
2. SOURCE
3. SOURCE
4. GATE
5. DRAIN

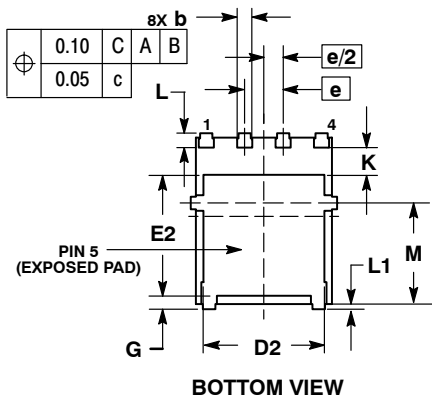
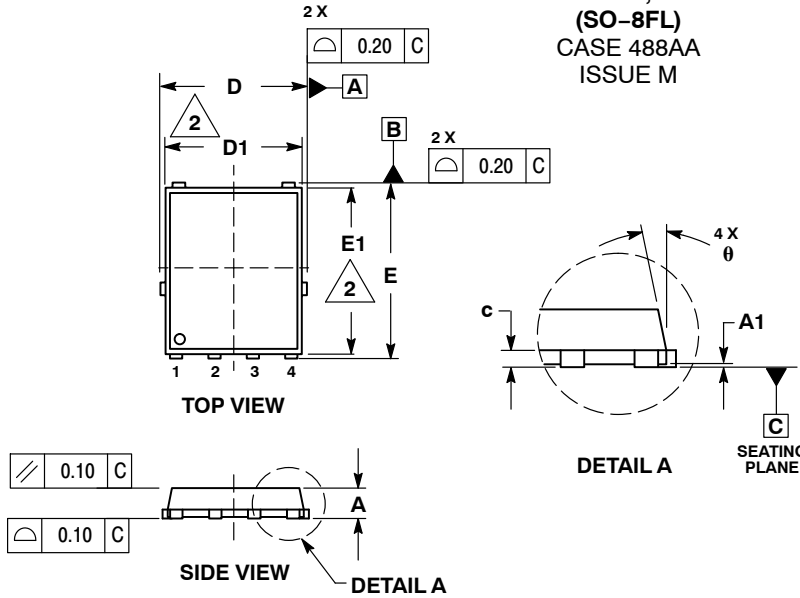

### RECOMMENDED SOLDERING FOOTPRINT\*

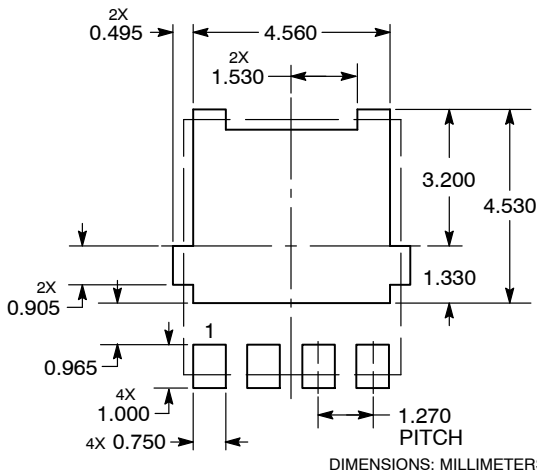

\*For additional information on our Pb-Free strategy and soldering details, please download the ON Semiconductor Soldering and Mounting Techniques Reference Manual, SOLDERRM/D.

ON Semiconductor and are trademarks of Semiconductor Components Industries, LLC dba ON Semiconductor or its subsidiaries in the United States and/or other countries. ON Semiconductor owns the rights to a number of patents, trademarks, copyrights, trade secrets, and other intellectual property. A listing of ON Semiconductor's product/patent coverage may be accessed at [www.onsemi.com/site/pdf/Patent-Marking.pdf](http://www.onsemi.com/site/pdf/Patent-Marking.pdf). ON Semiconductor reserves the right to make changes without further notice to any products herein. ON Semiconductor makes no warranty, representation or guarantee regarding the suitability of its products for any particular purpose, nor does ON Semiconductor assume any liability arising out of the application or use of any product or circuit, and specifically disclaims any and all liability, including without limitation special, consequential or incidental damages. Buyer is responsible for its products and applications using ON Semiconductor products, including compliance with all laws, regulations and safety requirements or standards, regardless of any support or applications information provided by ON Semiconductor. "Typical" parameters which may be provided in ON Semiconductor data sheets and/or specifications can and do vary in different applications and actual performance may vary over time. All operating parameters, including "Typicals" must be validated for each customer application by customer's technical experts. ON Semiconductor does not convey any license under its patent rights nor the rights of others. ON Semiconductor products are not designed, intended, or authorized for use as a critical component in life support systems or any FDA Class 3 medical devices or medical devices with a same or similar classification in a foreign jurisdiction or any devices intended for implantation in the human body. Should Buyer purchase or use ON Semiconductor products for any such unintended or unauthorized application, Buyer shall indemnify and hold ON Semiconductor and its officers, employees, subsidiaries, affiliates, and distributors harmless against all claims, costs, damages, and expenses, and reasonable attorney fees arising out of, directly or indirectly, any claim of personal injury or death associated with such unintended or unauthorized use, even if such claim alleges that ON Semiconductor was negligent regarding the design or manufacture of the part. ON Semiconductor is an Equal Opportunity/Affirmative Action Employer. This literature is subject to all applicable copyright laws and is not for resale in any manner.

### PUBLICATION ORDERING INFORMATION

LITERATURE FULFILLMENT:

Literature Distribution Center for ON Semiconductor  
19521 E. 32nd Pkwy, Aurora, Colorado 80011 USA  
Phone: 303-675-2175 or 800-344-3860 Toll Free USA/Canada  
Fax: 303-675-2176 or 800-344-3867 Toll Free USA/Canada  
Email: [orderlit@onsemi.com](mailto:orderlit@onsemi.com)

N. American Technical Support: 800-282-9855 Toll Free  
USA/Canada  
Europe, Middle East and Africa Technical Support:  
Phone: 421 33 790 2910

ON Semiconductor Website: [www.onsemi.com](http://www.onsemi.com)

Order Literature: <http://www.onsemi.com/orderlit>

For additional information, please contact your local Sales Representative