

# OPAx316-Q1 10-MHz, Rail-to-Rail Input/Output, Low-Voltage, 1.8-V CMOS Operational Amplifier

## 1 Features

- Qualified for Automotive Applications
- AEC-Q100 Qualified With the Following Results:
  - Device Temperature Grade 1: –40°C to +125°C Ambient Operating Temperature Range
  - Device HBM ESD Classification Level 3A
  - Device CDM ESD Classification Level C5
- Unity-Gain Bandwidth: 10 MHz
- Low  $I_Q$ : 400  $\mu$ A/ch
- Wide Supply Range: 1.8 V to 5.5 V
- Low Noise: 11 nV/ $\sqrt{\text{Hz}}$  at 1 kHz
- Low Input Bias Current:  $\pm 5$  pA
- Offset Voltage:  $\pm 0.5$  mV
- Unity-Gain Stable
- Internal RFI-EMI Filter
- Extended Temperature Range: –40°C to +125°C

## 2 Applications

- Automotive Applications:
  - ADAS
  - Body Electronics and Lighting
  - Current Sensing
  - Battery Management Systems

## 3 Description

The OPAx316-Q1 family of single and dual operational amplifiers represents a new generation of general-purpose, low-power operational amplifiers. Featuring rail-to-rail input and output swings, low quiescent current (400  $\mu$ A/ch typical) combined with a wide bandwidth of 10 MHz and very-low noise (11 nV/ $\sqrt{\text{Hz}}$  at 1 kHz) makes this family suitable for circuits requiring a good speed and power ratio. The low input bias current supports those operational amplifiers for applications with megaohm source impedances. The low input bias current of the OPAx316-Q1 yields a very-low current noise to make the device attractive for high impedance sensor interfaces.

The robust design of the OPAx316-Q1 provides ease-of-use to the circuit designer: a unity-gain stable, integrated RFI and EMI rejection filter, no phase reversal in overdrive condition, and high electrostatic discharge (ESD) protection (4-kV HBM).

These devices are optimized for low-voltage operation as low as 1.8 V ( $\pm 0.9$  V) and up to 5.5 V ( $\pm 2.75$  V). This latest addition of low-voltage CMOS automotive grade operational amplifiers provide a family of wide bandwidth, low noise, and low power that meet the needs of a wide variety of applications.

### Device Information<sup>(1)</sup>

| PART NUMBER | PACKAGE    | BODY SIZE (NOM)   |
|-------------|------------|-------------------|
| OPA316-Q1   | SOT-23 (5) | 1.60 mm x 2.90 mm |
| OPA2316-Q1  | VSSOP (8)  | 3.00 mm x 3.00 mm |
| OPA4316-Q1  | TSSOP (14) | 4.40 mm x 5.00 mm |

(1) For all available packages, see the orderable addendum at the end of the data sheet.

### Single-Pole, Low-Pass Filter

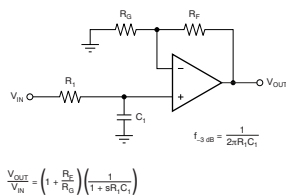

### Low-Supply Current (400 $\mu$ A/ch) for 10-MHz Bandwidth

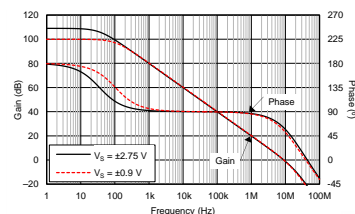

## Table of Contents

|  |           |  |           |
|--|-----------|--|-----------|
| <b>1 Features</b> .....                        | <b>1</b>  | 7.4 Device Functional Modes.....                                 | <b>20</b> |
| <b>2 Applications</b> .....                    | <b>1</b>  | <b>8 Application and Implementation</b> .....                    | <b>21</b> |
| <b>3 Description</b> .....                     | <b>1</b>  | 8.1 Application Information.....                                 | <b>21</b> |
| <b>4 Revision History</b> .....                | <b>2</b>  | 8.2 Typical Application .....                                    | <b>22</b> |
| <b>5 Pin Configuration and Functions</b> ..... | <b>3</b>  | <b>9 Power Supply Recommendations</b> .....                      | <b>25</b> |
| <b>6 Specifications</b> .....                  | <b>6</b>  | <b>10 Layout</b> .....   | <b>26</b> |
| 6.1 Absolute Maximum Ratings .....             | <b>6</b>  | 10.1 Layout Guidelines .....                                     | <b>26</b> |
| 6.2 ESD Ratings .....                          | <b>6</b>  | 10.2 Layout Example .....  | <b>26</b> |
| 6.3 Recommended Operating Conditions.....      | <b>6</b>  | <b>11 Device and Documentation Support</b> .....                 | <b>27</b> |
| 6.4 Thermal Information: OPA316-Q1 .....       | <b>7</b>  | 11.1 Documentation Support .....                                 | <b>27</b> |
| 6.5 Thermal Information: OPA2316-Q1 .....      | <b>8</b>  | 11.2 Related Links .....   | <b>27</b> |
| 6.6 Thermal Information: OPA4316-Q1 .....      | <b>9</b>  | 11.3 Receiving Notification of Documentation Updates .....       | <b>27</b> |
| 6.7 Electrical Characteristics.....            | <b>10</b> | 11.4 Community Resources.....                                    | <b>27</b> |
| 6.8 Typical Characteristics.....               | <b>12</b> | 11.5 Trademarks .....  | <b>27</b> |
| <b>7 Detailed Description</b> .....            | <b>18</b> | 11.6 Electrostatic Discharge Caution.....                        | <b>27</b> |
| 7.1 Overview .....                             | <b>18</b> | 11.7 Glossary .....  | <b>27</b> |
| 7.2 Functional Block Diagram .....             | <b>18</b> | <b>12 Mechanical, Packaging, and Orderable Information</b> ..... | <b>28</b> |
| 7.3 Feature Description.....                   | <b>18</b> |  |           |

## 4 Revision History

| <b>Changes from Original (November 2016) to Revision A</b>  | <b>Page</b> |
|---|-------------|
| • Changed CDM classification reduced from C6 .....  | <b>1</b>    |
| • Deleted OPA2316S-Q1 package and body size information from <i>Device Information</i> table .....  | <b>1</b>    |
| • Deleted SC70 (5) (OPA316-Q1), DFN (8), MSOP (8), SOIC (8) (OPA2316-Q1), and SOIC (14) packages (OPA4316-Q1) from the <i>Device Information</i> table, <i>Thermal Information</i> tables, and pinout diagrams..... | <b>1</b>    |
| • Deleted OPA2316S-Q1 pin diagram and Pin Functions table in <i>Pin Configurations and Functions</i> section .....  | <b>3</b>    |
| • Deleted D (SOIC) package from OPA4316-Q1 pin diagram in Pin Configurations and Functions section .....  | <b>5</b>    |
| • Changed CDM rating from $\pm 1500$ V to $\pm 750$ V .....   | <b>6</b>    |
| • Deleted OPA2316S-Q1 device thermal information in the <i>Thermal Information</i> table .....  | <b>7</b>    |
| • Added thermal information for OPA4316-Q1 device .....   | <b>9</b>    |
| • Deleted the literature numbers in parentheses from the format of TI document references in the <i>Documentation Support</i> section .....   | <b>27</b>   |

## 5 Pin Configuration and Functions

**OPA316-Q1 DBV Package  
5-Pin SOT-23  
Top View**

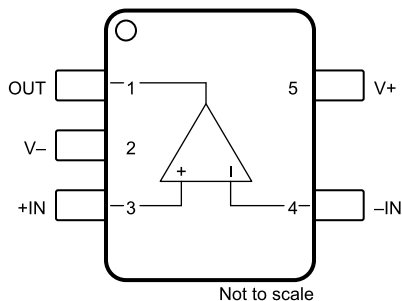

**Pin Functions: OPA316-Q1**

| PIN  |     | I/O | DESCRIPTION  |
|------|-----|-----|--|
| NAME | NO. |     |  |
| -IN  | 4   | I   | Inverting input  |
| +IN  | 3   | I   | Noninverting input                                       |
| V-   | 2   | —   | Negative supply or ground (for single-supply operation). |
| V+   | 5   | —   | Positive supply  |
| OUT  | 1   | O   | Output   |

**OPA2316-Q1 DGK Package**  
**8-Pin VSSOP**  
**Top View**

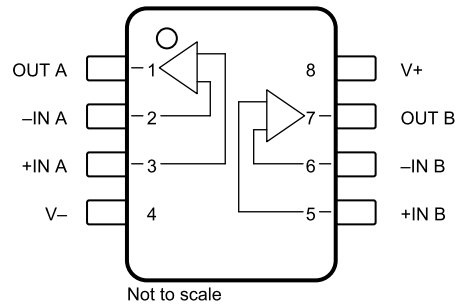

**Pin Functions: OPA2316-Q1**

| PIN   |     | I/O | DESCRIPTION  |
|-------|-----|-----|--|
| NAME  | NO. |     |  |
| -IN A | 2   | I   | Inverting input, channel A                               |
| +IN A | 3   | I   | Noninverting input, channel A                            |
| -IN B | 6   | I   | Inverting input, channel B                               |
| +IN B | 5   | I   | Noninverting input, channel B                            |
| OUT A | 1   | O   | Output, channel A  |
| OUT B | 7   | O   | Output, channel B  |
| V-    | 4   | —   | Negative supply or ground (for single-supply operation). |
| V+    | 8   | —   | Positive supply  |

**OPA4316-Q1 PW Package  
14-Pin TSSOP  
Top View**

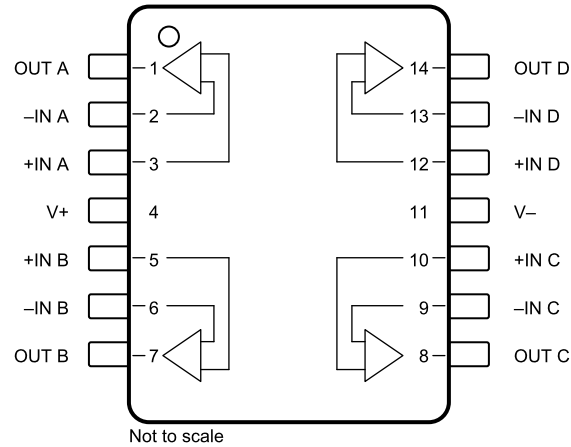

**Pin Functions: OPA4316-Q1**

| PIN   |     | I/O | DESCRIPTION   |
|-------|-----|-----|---|
| NAME  | NO. |     |   |
| -IN A | 2   | I   | Inverting input, channel A                              |
| +IN A | 3   | I   | Noninverting input, channel A                           |
| -IN B | 6   | I   | Inverting input, channel B                              |
| +IN B | 5   | I   | Noninverting input, channel B                           |
| -IN C | 9   | I   | Inverting input, channel C                              |
| +IN C | 10  | I   | Noninverting input, channel C                           |
| -IN D | 13  | I   | Inverting input, channel D                              |
| +IN D | 12  | I   | Noninverting input, channel D                           |
| OUT A | 1   | O   | Output, channel A                                       |
| OUT B | 7   | O   | Output, channel B                                       |
| OUT C | 8   | O   | Output, channel C                                       |
| OUT D | 14  | O   | Output, channel D                                       |
| V-    | 11  | —   | Negative supply or ground (for single-supply operation) |
| V+    | 4   | —   | Positive supply   |

## 6 Specifications

### 6.1 Absolute Maximum Ratings

 over operating free-air temperature (unless otherwise noted)<sup>(1)</sup>

|                                     |                        |              | MIN   | MAX                     | UNIT |
|-------------------------------------|------------------------|--------------|---|-------------------------|------|
| Supply voltage                      |                        |              | 7   |                         | V    |
| Signal input pins                   | Voltage <sup>(2)</sup> | Common-mode  | (V <sub>-</sub> ) - 0.5                     | (V <sub>+</sub> ) + 0.5 | V    |
|                                     |                        | Differential | (V <sub>+</sub> ) - (V <sub>-</sub> ) + 0.2 |                         | V    |
|                                     | Current <sup>(2)</sup> |              | -10   | 10                      | mA   |
| Output short-circuit <sup>(3)</sup> |                        |              | Continuous                                  |                         |      |
| T <sub>A</sub>                      | Operating temperature  |              | -55   | 150                     | °C   |
| T <sub>J</sub>                      | Junction temperature   |              |   | 150                     | °C   |
| T <sub>stg</sub>                    | Storage temperature    |              | -65   | 150                     | °C   |

- (1) Stresses beyond those listed under *Absolute Maximum Ratings* may cause permanent damage to the device. These are stress ratings only, which do not imply functional operation of the device at these or any other conditions beyond those indicated under *Recommended Operating Conditions*. Exposure to absolute-maximum-rated conditions for extended periods may affect device reliability.
- (2) Input pins are diode-clamped to the power-supply rails. Current limit input signals that can swing more than 0.5 V beyond the supply rails to 10 mA or less.
- (3) Short-circuit to ground, one amplifier per package.

### 6.2 ESD Ratings

|                    |                         |   | VALUE | UNIT |
|--------------------|-------------------------|---|-------|------|
| V <sub>(ESD)</sub> | Electrostatic discharge | Human-body model (HBM), per AEC Q100-002 <sup>(1)</sup> | ±4000 | V    |
|                    |                         | Charged-device model (CDM), per AEC Q100-011            | ±750  |      |

- (1) AEC Q100-002 indicates that HBM stressing shall be in accordance with the ANSI/ESDA/JEDEC JS-001 specification.

### 6.3 Recommended Operating Conditions

over operating free-air temperature range (unless otherwise noted)

|                |                       |  | MIN | MAX | UNIT |
|----------------|-----------------------|--|-----|-----|------|
| V <sub>S</sub> | Supply voltage        |  | 1.8 | 5.5 | V    |
|                | Specified temperature |  | -40 | 125 | °C   |

## 6.4 Thermal Information: OPA316-Q1

| THERMAL METRIC <sup>(1)</sup> |   | OPA316-Q1    | UNIT |
|-------------------------------|---|--------------|------|
|                               |   | DBV (SOT-23) |      |
|                               |   | 5 PINS       |      |
| $R_{\theta JA}$               | Junction-to-ambient thermal resistance <sup>(2)</sup>       | 221.7        | °C/W |
| $R_{\theta JC(top)}$          | Junction-to-case(top) thermal resistance <sup>(3)</sup>     | 144.7        | °C/W |
| $R_{\theta JB}$               | Junction-to-board thermal resistance <sup>(4)</sup>         | 49.7         | °C/W |
| $\Psi_{JT}$                   | Junction-to-top characterization parameter <sup>(5)</sup>   | 26.1         | °C/W |
| $\Psi_{JB}$                   | Junction-to-board characterization parameter <sup>(6)</sup> | 49           | °C/W |
| $R_{\theta JC(bot)}$          | Junction-to-case(bottom) thermal resistance <sup>(7)</sup>  | N/A          | °C/W |

- (1) For more information about traditional and new thermal metrics, see the [Semiconductor and IC Package Thermal Metrics](#) application report.
- (2) The junction-to-ambient thermal resistance under natural convection is obtained in a simulation on a JEDEC-standard, high-K board, as specified in JESD51-7, in an environment described in JESD51-2a.
- (3) The junction-to-case (top) thermal resistance is obtained by simulating a cold plate test on the package top. No specific JEDEC-standard test exists, but a close description can be found in the ANSI SEMI standard G30-88.
- (4) The junction-to-board thermal resistance is obtained by simulating in an environment with a ring cold plate fixture to control the PCB temperature, as described in JESD51-8.
- (5) The junction-to-top characterization parameter,  $\Psi_{JT}$ , estimates the junction temperature of a device in a real system and is extracted from the simulation data for obtaining  $R_{\theta JA}$ , using a procedure described in JESD51-2a (sections 6 and 7).
- (6) The junction-to-board characterization parameter,  $\Psi_{JB}$ , estimates the junction temperature of a device in a real system and is extracted from the simulation data for obtaining  $R_{\theta JA}$ , using a procedure described in JESD51-2a (sections 6 and 7).
- (7) The junction-to-case (bottom) thermal resistance is obtained by simulating a cold plate test on the exposed (power) pad. No specific JEDEC standard test exists, but a close description can be found in the ANSI SEMI standard G30-88.

## 6.5 Thermal Information: OPA2316-Q1

| THERMAL METRIC <sup>(1)</sup> |   | OPA2316-Q1  | UNIT |
|-------------------------------|---|-------------|------|
|                               |   | DGK (VSSOP) |      |
|                               |   | 8 PINS      |      |
| $R_{\theta JA}$               | Junction-to-ambient thermal resistance <sup>(2)</sup>       | 186.6       | °C/W |
| $R_{\theta JC(top)}$          | Junction-to-case(top) thermal resistance <sup>(3)</sup>     | 78.8        | °C/W |
| $R_{\theta JB}$               | Junction-to-board thermal resistance <sup>(4)</sup>         | 107.9       | °C/W |
| $\Psi_{JT}$                   | Junction-to-top characterization parameter <sup>(5)</sup>   | 15.5        | °C/W |
| $\Psi_{JB}$                   | Junction-to-board characterization parameter <sup>(6)</sup> | 106.3       | °C/W |
| $R_{\theta JC(bot)}$          | Junction-to-case(bottom) thermal resistance <sup>(7)</sup>  | N/A         | °C/W |

- (1) For more information about traditional and new thermal metrics, see the [Semiconductor and IC Package Thermal Metrics](#) application report.
- (2) The junction-to-ambient thermal resistance under natural convection is obtained in a simulation on a JEDEC-standard, high-K board, as specified in JESD51-7, in an environment described in JESD51-2a.
- (3) The junction-to-case (top) thermal resistance is obtained by simulating a cold plate test on the package top. No specific JEDEC-standard test exists, but a close description can be found in the ANSI SEMI standard G30-88.
- (4) The junction-to-board thermal resistance is obtained by simulating in an environment with a ring cold plate fixture to control the PCB temperature, as described in JESD51-8.
- (5) The junction-to-top characterization parameter,  $\Psi_{JT}$ , estimates the junction temperature of a device in a real system and is extracted from the simulation data for obtaining  $R_{\theta JA}$ , using a procedure described in JESD51-2a (sections 6 and 7).
- (6) The junction-to-board characterization parameter,  $\Psi_{JB}$ , estimates the junction temperature of a device in a real system and is extracted from the simulation data for obtaining  $R_{\theta JA}$ , using a procedure described in JESD51-2a (sections 6 and 7).
- (7) The junction-to-case (bottom) thermal resistance is obtained by simulating a cold plate test on the exposed (power) pad. No specific JEDEC standard test exists, but a close description can be found in the ANSI SEMI standard G30-88.

## 6.6 Thermal Information: OPA4316-Q1

| THERMAL METRIC <sup>(1)</sup> |   | OPA4316-Q1 | UNIT |
|-------------------------------|---|------------|------|
|                               |   | PW (TSSOP) |      |
|                               |   | 14 PINS    |      |
| $R_{\theta JA}$               | Junction-to-ambient thermal resistance <sup>(2)</sup>       | 117.2      | °C/W |
| $R_{\theta JC(top)}$          | Junction-to-case(top) thermal resistance <sup>(3)</sup>     | 46.2       | °C/W |
| $R_{\theta JB}$               | Junction-to-board thermal resistance <sup>(4)</sup>         | 58.9       | °C/W |
| $\Psi_{JT}$                   | Junction-to-top characterization parameter <sup>(5)</sup>   | 4.9        | °C/W |
| $\Psi_{JB}$                   | Junction-to-board characterization parameter <sup>(6)</sup> | 58.3       | °C/W |
| $R_{\theta JC(bot)}$          | Junction-to-case(bottom) thermal resistance <sup>(7)</sup>  | N/A        | °C/W |

- (1) For more information about traditional and new thermal metrics, see the [Semiconductor and IC Package Thermal Metrics](#) application report.
- (2) The junction-to-ambient thermal resistance under natural convection is obtained in a simulation on a JEDEC-standard, high-K board, as specified in JESD51-7, in an environment described in JESD51-2a.
- (3) The junction-to-case (top) thermal resistance is obtained by simulating a cold plate test on the package top. No specific JEDEC-standard test exists, but a close description can be found in the ANSI SEMI standard G30-88.
- (4) The junction-to-board thermal resistance is obtained by simulating in an environment with a ring cold plate fixture to control the PCB temperature, as described in JESD51-8.
- (5) The junction-to-top characterization parameter,  $\Psi_{JT}$ , estimates the junction temperature of a device in a real system and is extracted from the simulation data for obtaining  $R_{\theta JA}$ , using a procedure described in JESD51-2a (sections 6 and 7).
- (6) The junction-to-board characterization parameter,  $\Psi_{JB}$ , estimates the junction temperature of a device in a real system and is extracted from the simulation data for obtaining  $R_{\theta JA}$ , using a procedure described in JESD51-2a (sections 6 and 7).
- (7) The junction-to-case (bottom) thermal resistance is obtained by simulating a cold plate test on the exposed (power) pad. No specific JEDEC standard test exists, but a close description can be found in the ANSI SEMI standard G30-88.

## 6.7 Electrical Characteristics

 $V_S$  (total supply voltage) =  $(V+) - (V-) = 1.8\text{ V to }5.5\text{ V}$ .

 at  $T_A = 25^\circ\text{C}$ ,  $R_L = 10\text{ k}\Omega$  connected to  $V_S / 2$ ,  $V_{CM} = V_S / 2$ , and  $V_{OUT} = V_S / 2$ , unless otherwise noted

| PARAMETER                  |  | TEST CONDITIONS   | MIN          | TYP             | MAX          | UNIT                                |
|----------------------------|--|---|--------------|-----------------|--------------|-------------------------------------|
| <b>OFFSET VOLTAGE</b>      |  |   |              |                 |              |                                     |
| $V_{OS}$                   | Input offset voltage                             | $V_S = 5\text{ V}$  |              | $\pm 0.5$       | $\pm 2.5$    | mV                                  |
|                            |  | $V_S = 5\text{ V}$ , $T_A = -40^\circ\text{C to }125^\circ\text{C}$   |              |                 | $\pm 3.5$    | mV                                  |
| $dV_{OS}/dT$               | Drift  | $V_S = 5\text{ V}$ , $T_A = -40^\circ\text{C to }125^\circ\text{C}$   |              | $\pm 2$         | $\pm 10$     | $\mu\text{V}/^\circ\text{C}$        |
| PSRR                       | vs power supply                                  | $V_S = 1.8\text{ V} - 5.5\text{ V}$ , $V_{CM} = (V-)$   |              | $\pm 30$        | $\pm 150$    | $\mu\text{V}/\text{V}$              |
|                            |  | $V_S = 1.8\text{ V} - 5.5\text{ V}$ , $V_{CM} = (V-)$ , $T_A = -40^\circ\text{C to }125^\circ\text{C}$  |              |                 | $\pm 250$    | $\mu\text{V}/\text{V}$              |
|                            | Channel separation, dc                           | At dc   |              | 10              |              | $\mu\text{V}/\text{V}$              |
| <b>INPUT VOLTAGE RANGE</b> |  |   |              |                 |              |                                     |
| $V_{CM}$                   | Common-mode voltage                              | $V_S = 1.8\text{ V to }2.5\text{ V}$  | $(V-) - 0.2$ |                 | $(V+)$       | V                                   |
|                            |  | $V_S = 2.5\text{ V to }5.5\text{ V}$  | $(V-) - 0.2$ |                 | $(V+) + 0.2$ | V                                   |
| CMRR                       | Common-mode rejection ratio                      | $V_S = 1.8\text{ V}$ , $(V-) - 0.2\text{ V} < V_{CM} < (V+) - 1.4\text{ V}$ , $T_A = -40^\circ\text{C to }125^\circ\text{C}$                            | 70           | 86              |              | dB                                  |
|                            |  | $V_S = 5.5\text{ V}$ , $(V-) - 0.2\text{ V} < V_{CM} < (V+) - 1.4\text{ V}$ , $T_A = -40^\circ\text{C to }125^\circ\text{C}$                            | 76           | 90              |              | dB                                  |
|                            |  | $V_S = 1.8\text{ V}$ , $V_{CM} = -0.2\text{ V to }1.8\text{ V}$ , $T_A = -40^\circ\text{C to }125^\circ\text{C}$  | 57           | 72              |              | dB                                  |
|                            |  | $V_S = 5.5\text{ V}$ , $V_{CM} = -0.2\text{ V to }5.7\text{ V}$ , $T_A = -40^\circ\text{C to }125^\circ\text{C}$  | 65           | 80              |              | dB                                  |
| <b>INPUT BIAS CURRENT</b>  |  |   |              |                 |              |                                     |
| $I_B$                      | Input bias current                               |   |              | $\pm 5$         | $\pm 15$     | pA                                  |
|                            |  | $T_A = -40^\circ\text{C to }125^\circ\text{C}$  |              |                 | $\pm 15$     | nA                                  |
| $I_{OS}$                   | Input offset current                             |   |              | $\pm 2$         | $\pm 15$     | pA                                  |
|                            |  | $T_A = -40^\circ\text{C to }125^\circ\text{C}$  |              |                 | $\pm 8$      | nA                                  |
| <b>NOISE</b>               |  |   |              |                 |              |                                     |
| $E_n$                      | Input voltage noise (peak-to-peak)               | $V_S = 5\text{ V}$ , $f = 0.1\text{ Hz to }10\text{ Hz}$  |              | 3               |              | $\mu\text{V}_{PP}$                  |
| $e_n$                      | Input voltage noise density                      | $V_S = 5\text{ V}$ , $f = 1\text{ kHz}$   |              | 11              |              | $\text{nV}/\sqrt{\text{Hz}}$        |
| $i_n$                      | Input current noise density                      | $f = 1\text{ kHz}$  |              | 1.3             |              | $\text{fA}/\sqrt{\text{Hz}}$        |
| <b>INPUT IMPEDANCE</b>     |  |   |              |                 |              |                                     |
| $Z_{ID}$                   | Differential                                     |   |              | $2 \parallel 2$ |              | $10^{16}\Omega \parallel \text{pF}$ |
| $Z_{IC}$                   | Common-mode                                      |   |              | $2 \parallel 4$ |              | $10^{11}\Omega \parallel \text{pF}$ |
| <b>OPEN-LOOP GAIN</b>      |  |   |              |                 |              |                                     |
| $A_{OL}$                   | Open-loop voltage gain                           | $V_S = 1.8\text{ V}$ , $(V-) + 0.04\text{ V} < V_O < (V+) - 0.04\text{ V}$ , $R_L = 10\text{ k}\Omega$  | 94           | 100             |              | dB                                  |
|                            |  | $V_S = 5.5\text{ V}$ , $(V-) + 0.05\text{ V} < V_O < (V+) - 0.05\text{ V}$ , $R_L = 10\text{ k}\Omega$  | 104          | 110             |              | dB                                  |
|                            |  | $V_S = 1.8\text{ V}$ , $(V-) + 0.1\text{ V} < V_O < (V+) - 0.1\text{ V}$ , $R_L = 2\text{ k}\Omega$   | 90           | 96              |              | dB                                  |
|                            |  | $V_S = 5.5\text{ V}$ , $(V-) + 0.15\text{ V} < V_O < (V+) - 0.15\text{ V}$ , $R_L = 2\text{ k}\Omega$   | 100          | 106             |              | dB                                  |
|                            |  | $V_S = 5.5\text{ V}$ , $(V-) + 0.05\text{ V} < V_O < (V+) - 0.05\text{ V}$ , $R_L = 10\text{ k}\Omega$ , $T_A = -40^\circ\text{C to }125^\circ\text{C}$ | 86           |                 |              | dB                                  |
|                            |  | $V_S = 5.5\text{ V}$ , $(V-) + 0.15\text{ V} < V_O < (V+) - 0.15\text{ V}$ , $R_L = 2\text{ k}\Omega$ , $T_A = -40^\circ\text{C to }125^\circ\text{C}$  | 84           |                 |              | dB                                  |
| <b>FREQUENCY RESPONSE</b>  |  |   |              |                 |              |                                     |
| GBP                        | Gain bandwidth product                           | $V_S = 5\text{ V}$ , $G = 1$  |              | 10              |              | MHz                                 |
| $\phi_m$                   | Phase margin                                     | $V_S = 5\text{ V}$ , $G = 1$  |              | 60              |              | Degrees                             |
| SR                         | Slew rate  | $V_S = 5\text{ V}$ , $G = 1$  |              | 6               |              | $\text{V}/\mu\text{s}$              |
| $t_s$                      | Settling time                                    | To 0.1%, $V_S = 5\text{ V}$ , 2-V step, $G = 1$ , $C_L = 100\text{ pF}$   |              | 1               |              | $\mu\text{s}$                       |
|                            |  | To 0.01%, $V_S = 5\text{ V}$ , 2-V step, $G = 1$ , $C_L = 100\text{ pF}$  |              | 1.66            |              | $\mu\text{s}$                       |
| $t_{OR}$                   | Overload recovery time                           | $V_S = 5\text{ V}$ , $V_{IN} \times \text{gain} = V_S$  |              | 0.3             |              | $\mu\text{s}$                       |
| THD + N                    | Total harmonic distortion + noise <sup>(1)</sup> | $V_S = 5\text{ V}$ , $V_O = 0.5\text{ V}_{RMS}$ , $G = 1$ , $f = 1\text{ kHz}$  |              | 0.0008%         |              |                                     |

(1) Third-order filter; bandwidth = 80 kHz at -3 dB.

## Electrical Characteristics (continued)

 $V_S$  (total supply voltage) = (V+) – (V–) = 1.8 V to 5.5 V.

 at  $T_A = 25^\circ\text{C}$ ,  $R_L = 10\text{ k}\Omega$  connected to  $V_S / 2$ ,  $V_{CM} = V_S / 2$ , and  $V_{OUT} = V_S / 2$ , unless otherwise noted

| PARAMETER           | TEST CONDITIONS                        | MIN   | TYP | MAX      | UNIT          |               |
|---------------------|--|---|-----|----------|---------------|---------------|
| <b>OUTPUT</b>       |  |   |     |          |               |               |
| $V_O$               | Voltage output swing from supply rails | $V_S = 1.8\text{ V}$ , $R_L = 10\text{ k}\Omega$ , $T_A = -40^\circ\text{C}$ to $125^\circ\text{C}$ |     | 15       | mV            |               |
|                     |  | $V_S = 5.5\text{ V}$ , $R_L = 10\text{ k}\Omega$ , $T_A = -40^\circ\text{C}$ to $125^\circ\text{C}$ |     | 30       | mV            |               |
|                     |  | $V_S = 1.8\text{ V}$ , $R_L = 2\text{ k}\Omega$ , $T_A = -40^\circ\text{C}$ to $125^\circ\text{C}$  |     | 60       | mV            |               |
|                     |  | $V_S = 5.5\text{ V}$ , $R_L = 2\text{ k}\Omega$ , $T_A = -40^\circ\text{C}$ to $125^\circ\text{C}$  |     | 120      | mV            |               |
| $I_{SC}$            | Short-circuit current                  | $V_S = 5\text{ V}$  |     | $\pm 50$ | mA            |               |
| $Z_O$               | Open-loop output impedance             | $V_S = 5\text{ V}$ , $f = 10\text{ MHz}$  |     | 250      | $\Omega$      |               |
| <b>POWER SUPPLY</b> |  |   |     |          |               |               |
| $V_S$               | Specified voltage                      | 1.8   |     | 5.5      | V             |               |
| $I_Q$               | Quiescent current per amplifier        | $V_S = 5\text{ V}$ , $I_O = 0\text{ mA}$ , $T_A = -40^\circ\text{C}$ to $125^\circ\text{C}$         |     | 400      | 500           | $\mu\text{A}$ |
|                     | Power-on time                          | $V_S = 0\text{ V}$ to $5.5\text{ V}$  |     | 200      | $\mu\text{s}$ |               |

## 6.8 Typical Characteristics

at  $T_A = 25^\circ\text{C}$ ,  $V_S = 5.5\text{ V}$ ,  $R_L = 10\text{ k}\Omega$  connected to  $V_S / 2$ ,  $V_{CM} = V_S / 2$ , and  $V_{OUT} = V_S / 2$ , unless otherwise noted.

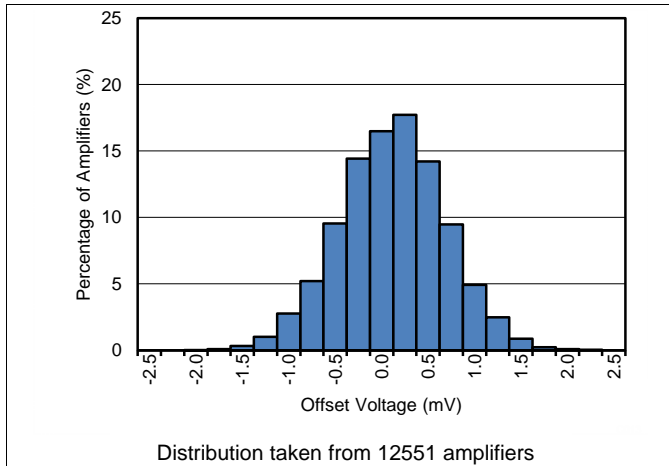

Figure 1. Offset Voltage Production Distribution

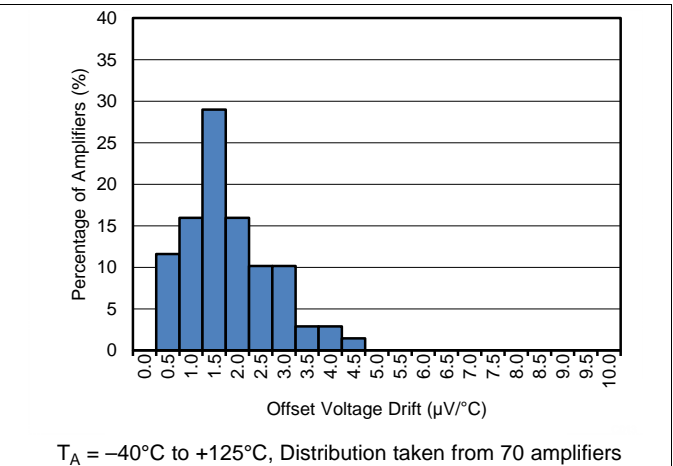

Figure 2. Offset Voltage Drift Distribution

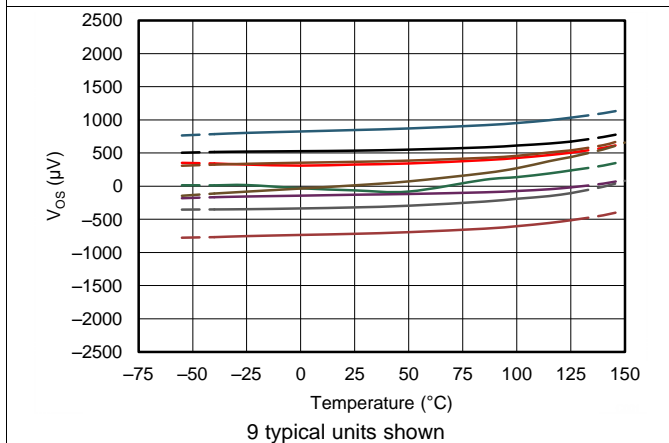

Figure 3. Offset Voltage vs Temperature

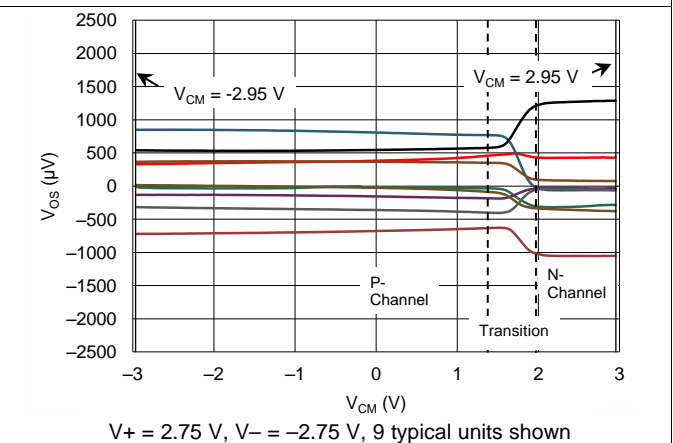

Figure 4. Offset Voltage vs Common-Mode Voltage

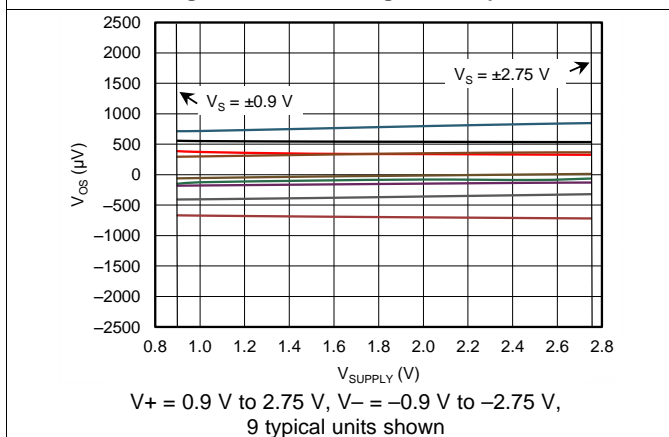

Figure 5. Offset Voltage vs Power Supply

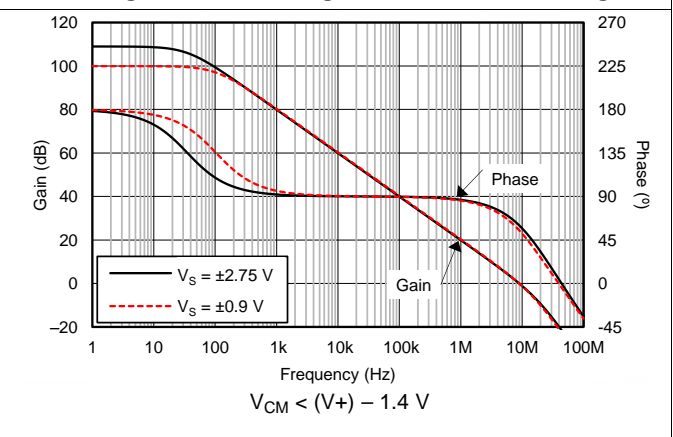

Figure 6. Open-Loop Gain and Phase vs Frequency

Typical Characteristics (continued)

at  $T_A = 25^\circ\text{C}$ ,  $V_S = 5.5\text{ V}$ ,  $R_L = 10\text{ k}\Omega$  connected to  $V_S / 2$ ,  $V_{CM} = V_S / 2$ , and  $V_{OUT} = V_S / 2$ , unless otherwise noted.

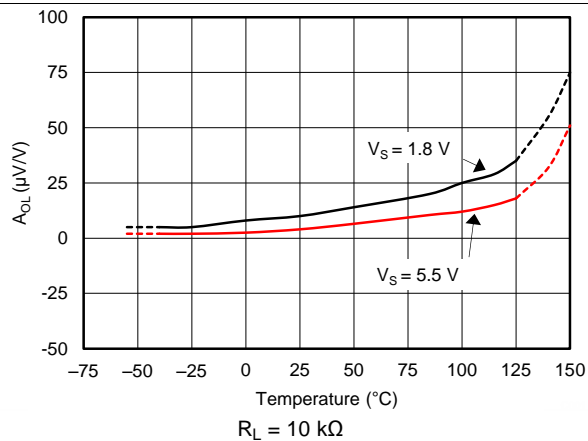

Figure 7. Open-Loop Gain vs Temperature

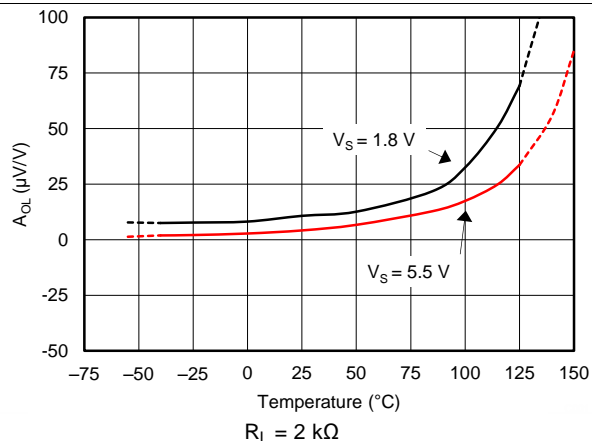

Figure 8. Open-Loop Gain vs Temperature

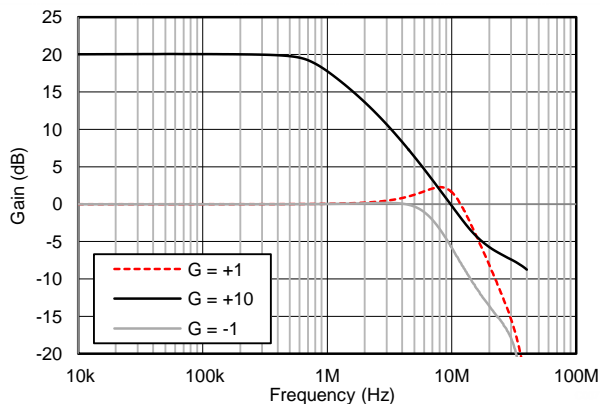

Figure 9. Closed-Loop Gain vs Frequency

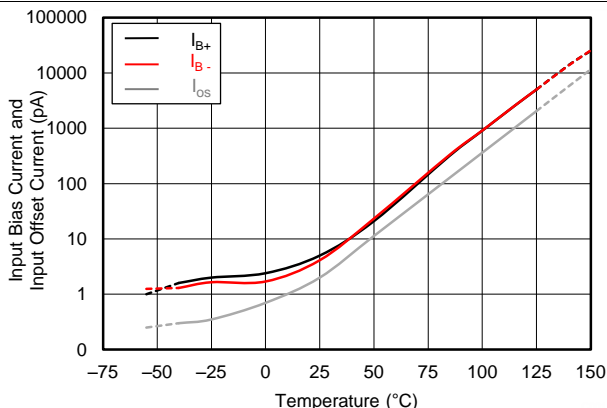

Figure 10. Input Bias and Offset Current vs Temperature

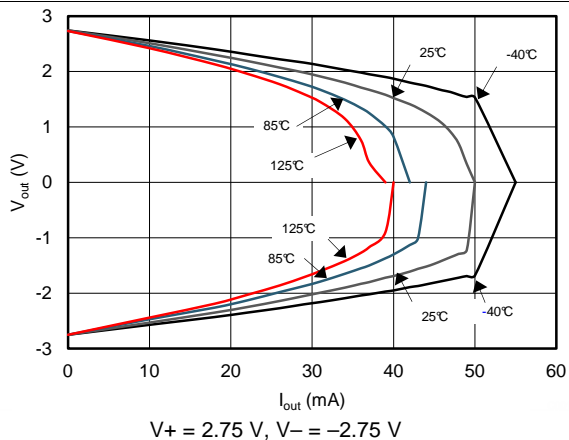

Figure 11. Output Voltage Swing vs Output Current

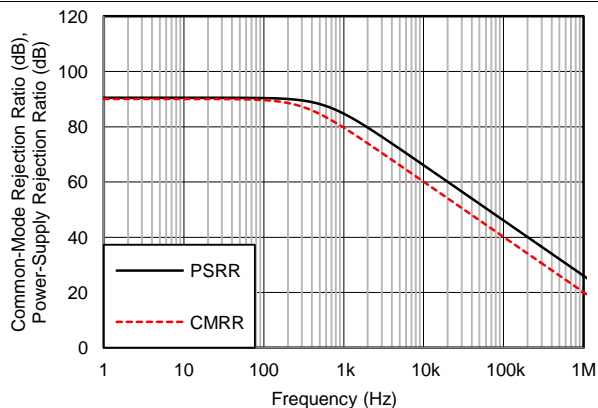

Figure 12. CMRR and PSRR vs Frequency (Referred to Input)

### Typical Characteristics (continued)

at  $T_A = 25^\circ\text{C}$ ,  $V_S = 5.5\text{ V}$ ,  $R_L = 10\text{ k}\Omega$  connected to  $V_S / 2$ ,  $V_{CM} = V_S / 2$ , and  $V_{OUT} = V_S / 2$ , unless otherwise noted.

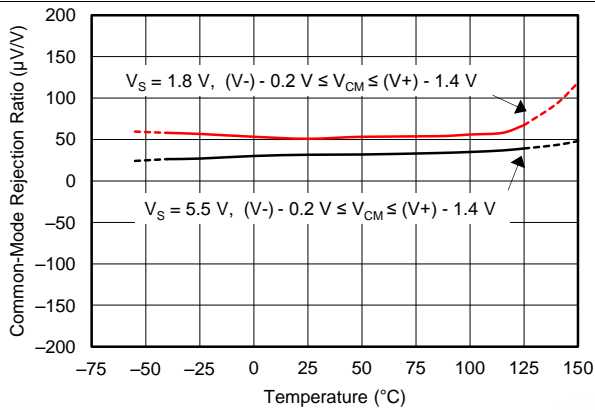

Figure 13. CMRR vs Temperature (Narrow Range)

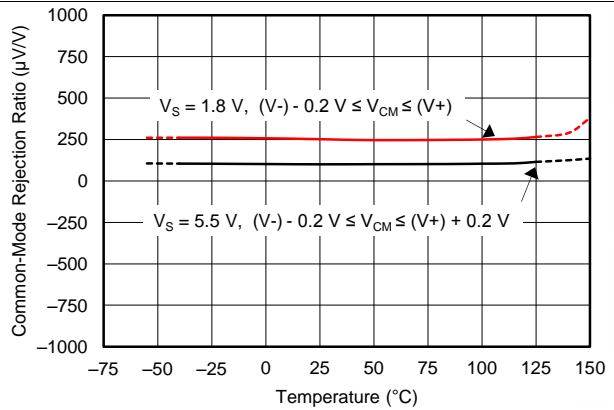

Figure 14. CMRR vs Temperature (Wide Range)

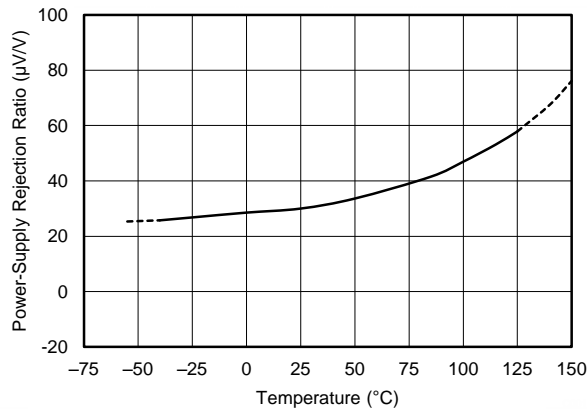

Figure 15. PSRR vs Temperature

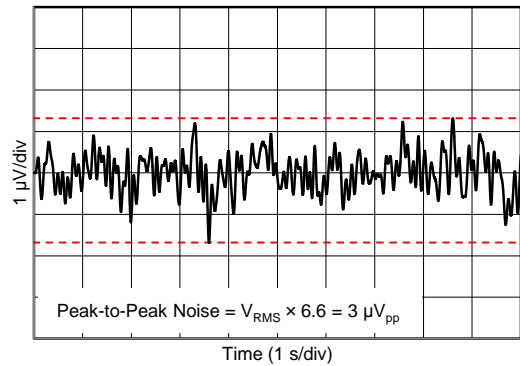

Figure 16. 0.1-Hz to 10-Hz Input Voltage Noise

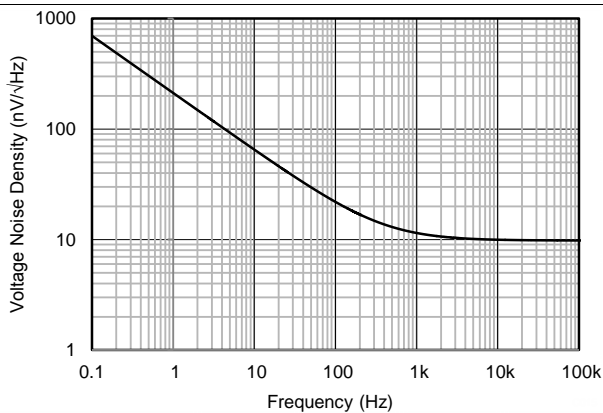

Figure 17. Input Voltage Noise Spectral Density vs Frequency

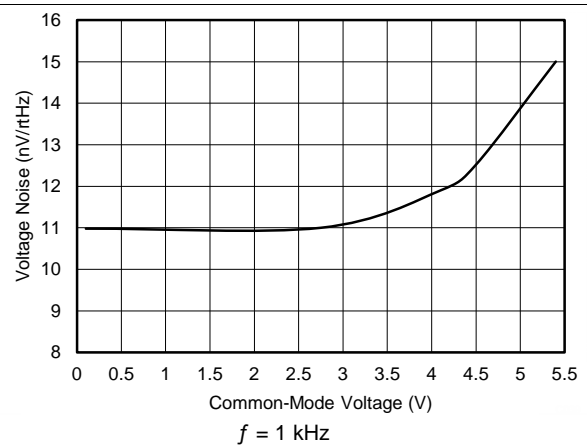

Figure 18. Input Voltage Noise vs Common-Mode Voltage

Typical Characteristics (continued)

at  $T_A = 25^\circ\text{C}$ ,  $V_S = 5.5\text{ V}$ ,  $R_L = 10\text{ k}\Omega$  connected to  $V_S / 2$ ,  $V_{CM} = V_S / 2$ , and  $V_{OUT} = V_S / 2$ , unless otherwise noted.

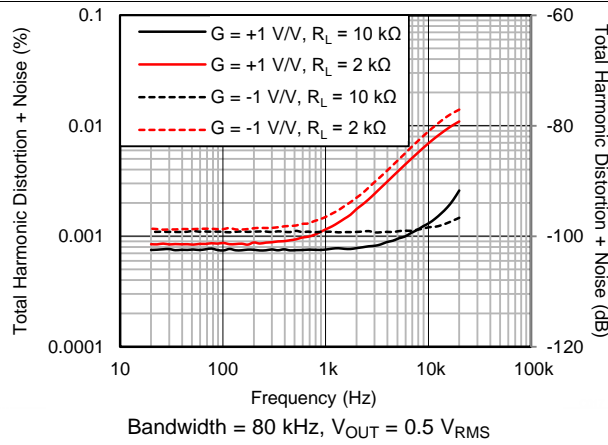

Figure 19. THD + N vs Frequency

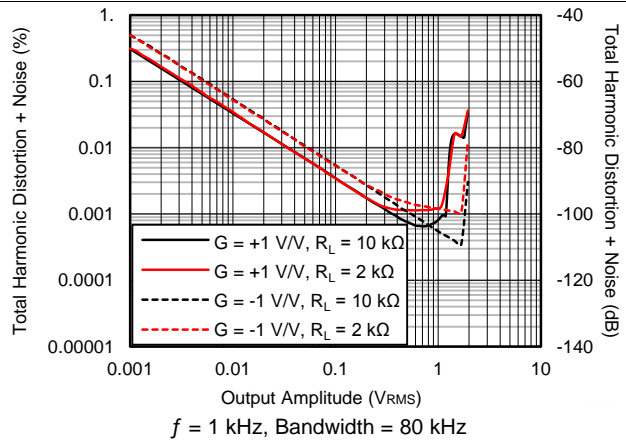

Figure 20. THD + N vs Amplitude

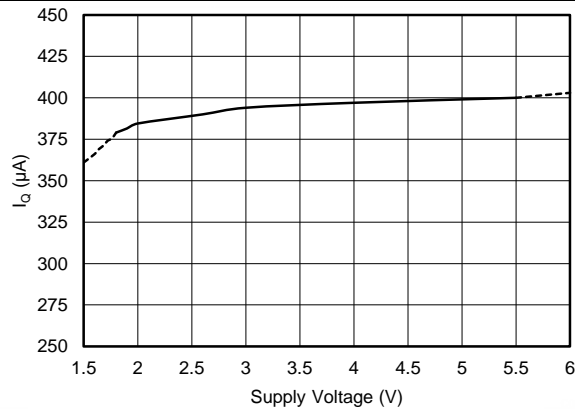

Figure 21. Quiescent Current vs Supply Voltage

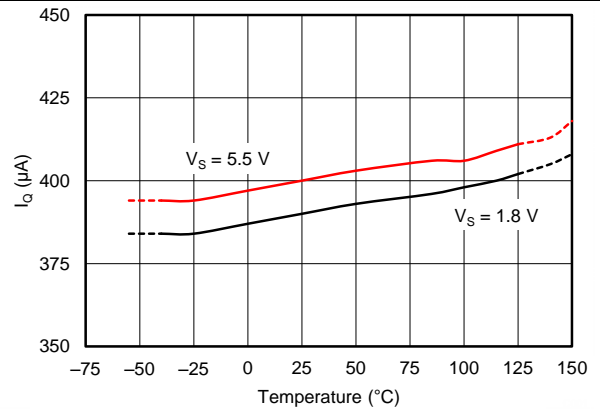

Figure 22. Quiescent Current vs Temperature

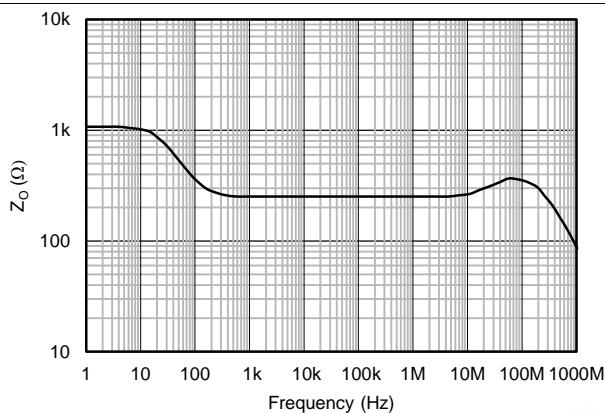

Figure 23. Open-Loop Output Impedance vs Frequency

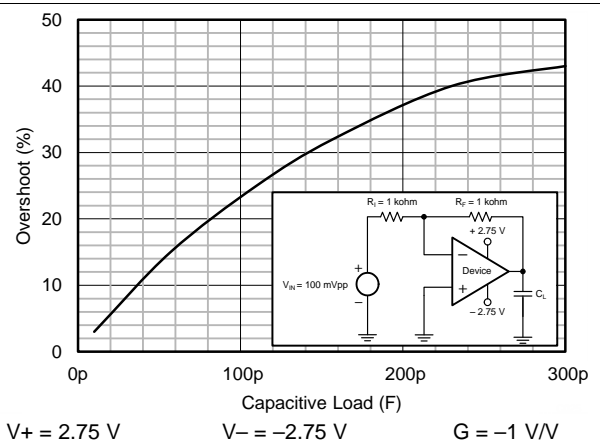

Figure 24. Small-Signal Overshoot vs Load Capacitance

Typical Characteristics (continued)

at  $T_A = 25^\circ\text{C}$ ,  $V_S = 5.5\text{ V}$ ,  $R_L = 10\text{ k}\Omega$  connected to  $V_S / 2$ ,  $V_{CM} = V_S / 2$ , and  $V_{OUT} = V_S / 2$ , unless otherwise noted.

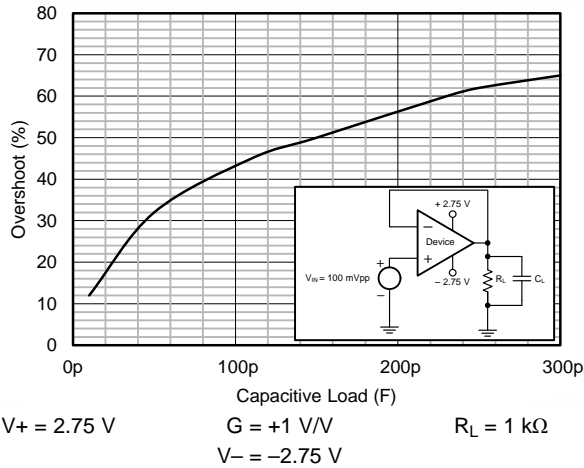

Figure 25. Small-Signal Overshoot vs Load Capacitance

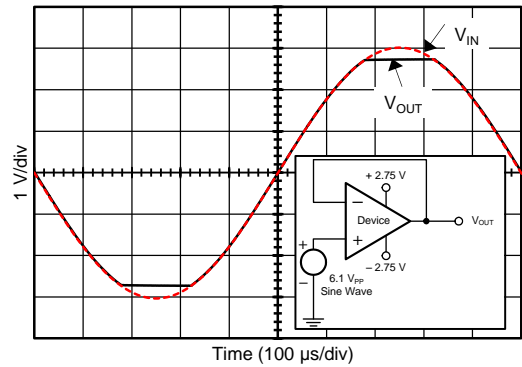

Figure 26. No Phase Reversal

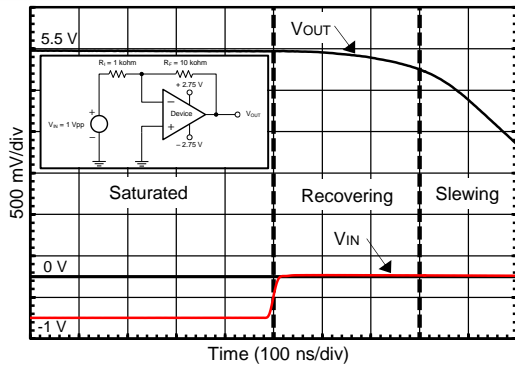

Figure 27. Positive Overload Recovery

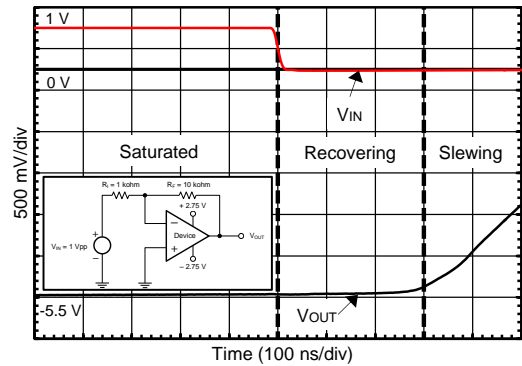

Figure 28. Negative Overload Recovery

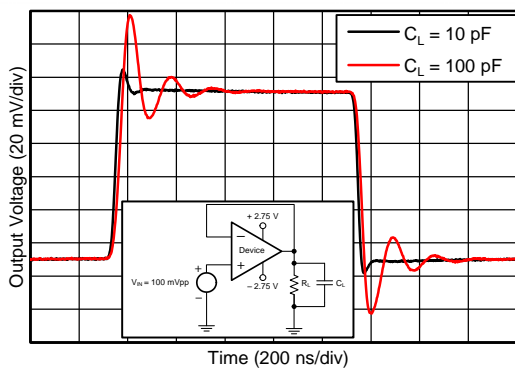

Figure 29. Small-Signal Step Response

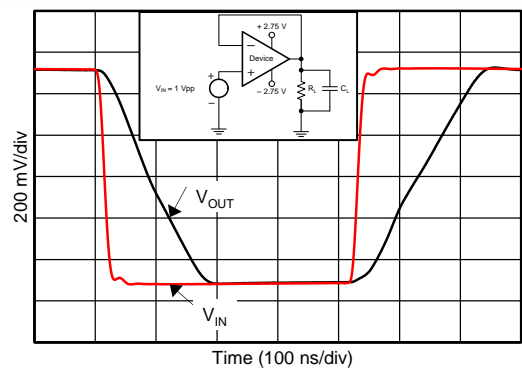

Figure 30. Large-Signal Step Response

Typical Characteristics (continued)

at  $T_A = 25^\circ\text{C}$ ,  $V_S = 5.5\text{ V}$ ,  $R_L = 10\text{ k}\Omega$  connected to  $V_S / 2$ ,  $V_{CM} = V_S / 2$ , and  $V_{OUT} = V_S / 2$ , unless otherwise noted.

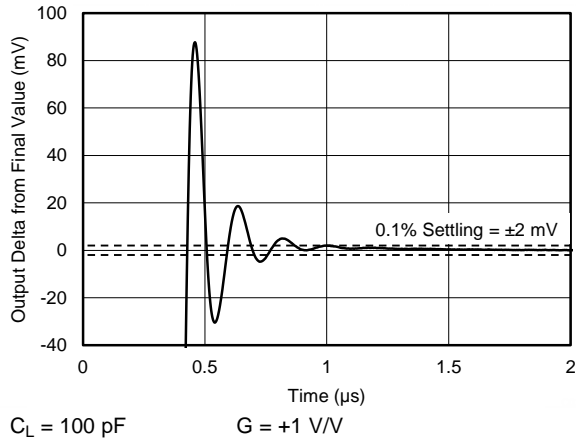

Figure 31. Positive Large-Signal Settling Time

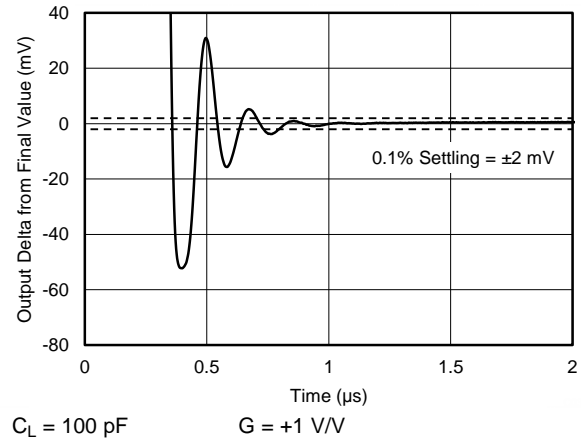

Figure 32. Negative Large-Signal Settling Time

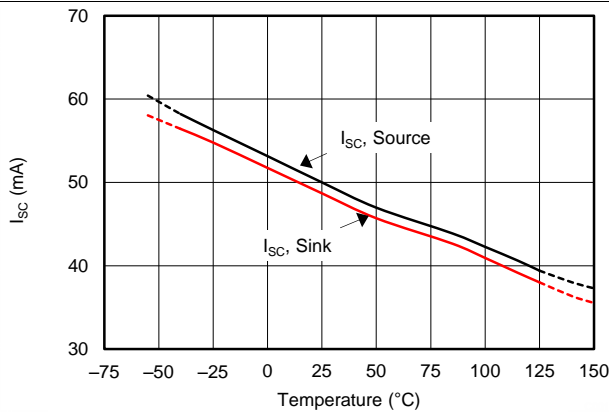

Figure 33. Short-Circuit Current vs Temperature

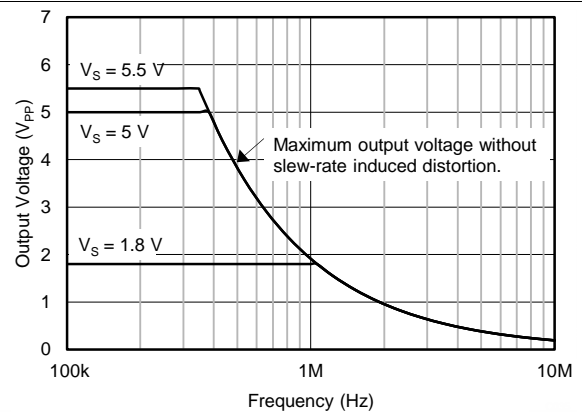

Figure 34. Maximum Output Voltage vs Frequency and Supply Voltage

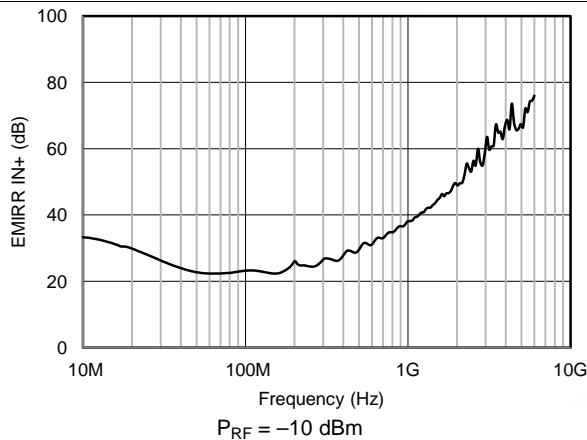

Figure 35. Electromagnetic Interference Rejection Ratio Referred to Noninverting Input (EMIRR IN+) vs Frequency

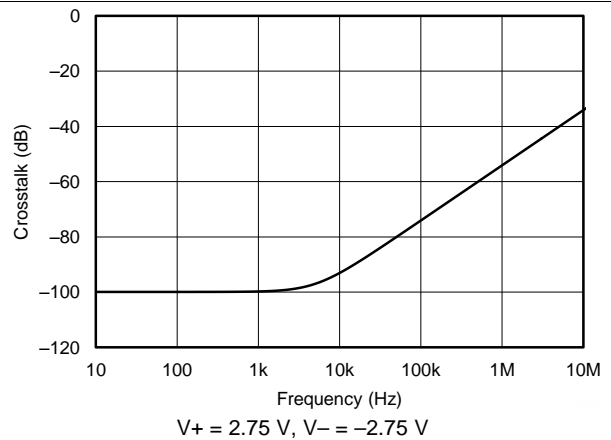

Figure 36. Channel Separation vs Frequency

## 7 Detailed Description

### 7.1 Overview

The OPAx316-Q1 is a family of low-power, rail-to-rail input and output operational amplifiers. These devices operate from 1.8 V to 5.5 V, are unity-gain stable, and are suitable for a wide range of general-purpose applications. The class AB output stage is capable of driving less than or equal to 10-k $\Omega$  loads connected to any point between V+ and ground. The input common-mode voltage range includes both rails and allows the OPAx316-Q1 series to be used in virtually any single-supply application. Rail-to-rail input and output swing significantly increases dynamic range, especially in low-supply applications, and makes them suitable for driving sampling analog-to-digital converters (ADCs).

The OPAx316-Q1 family features 10-MHz bandwidth and 6-V/ $\mu$ s slew rate with only 400- $\mu$ A supply current per channel, providing good ac performance at very-low-power consumption. DC applications are well served with a very-low input noise voltage of 11 nV/ $\sqrt{\text{Hz}}$  at 1 kHz, low input bias current (5 pA), and a typical input offset voltage of 0.5-mV.

### 7.2 Functional Block Diagram

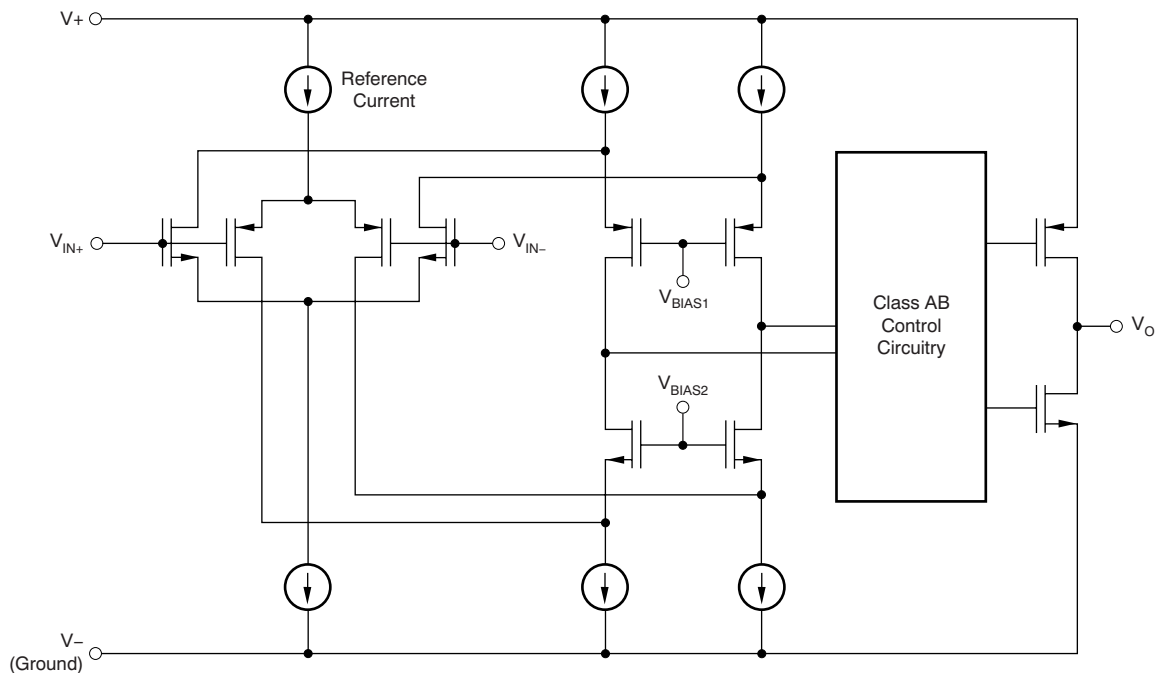

### 7.3 Feature Description

#### 7.3.1 Operating Voltage

The OPAx316-Q1 operational amplifiers are fully specified and ensured for operation from 1.8 V to 5.5 V. In addition, many specifications apply from  $-40^{\circ}\text{C}$  to  $+125^{\circ}\text{C}$ . Parameters that vary significantly with operating voltages or temperature are illustrated in the [Typical Characteristics](#) graphs.

## Feature Description (continued)

### 7.3.2 Rail-to-Rail Input

The input common-mode voltage range of the OPAx316-Q1 series extends 200 mV beyond the supply rails for supply voltages greater than 2.5 V. This performance is achieved with a complementary input stage: an N-channel input differential pair in parallel with a P-channel differential pair, as shown in the [Functional Block Diagram](#). The N-channel pair is active for input voltages close to the positive rail, typically  $(V+) - 1.4$  V to 200 mV above the positive supply, whereas the P-channel pair is active for inputs from 200 mV below the negative supply to approximately  $(V+) - 1.4$  V. There is a small transition region, typically  $(V+) - 1.2$  V to  $(V+) - 1$  V, in which both pairs are on. This 200-mV transition region can vary up to 200 mV with process variation. Thus, the transition region (both stages on) can range from  $(V+) - 1.4$  V to  $(V+) - 1.2$  V on the low end, up to  $(V+) - 1$  V to  $(V+) - 0.8$  V on the high end. Within this transition region, PSRR, CMRR, offset voltage, offset drift, and THD can degrade compared to device operation outside this region.

### 7.3.3 Input and ESD Protection

The OPAx316-Q1 incorporates internal ESD protection circuits on all pins. In the case of input and output pins, this protection primarily consists of current-steering diodes connected between the input and power-supply pins. These ESD protection diodes provide in-circuit, input overdrive protection, as long as the current is limited to 10 mA, as stated in [Absolute Maximum Ratings](#) table. [Figure 37](#) shows how a series input resistor can be added to the driven input to limit the input current. The added resistor contributes thermal noise at the amplifier input and the value must be kept to a minimum in noise-sensitive applications.

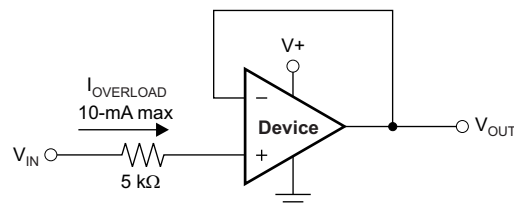

**Figure 37. Input Current Protection**

### 7.3.4 Common-Mode Rejection Ratio (CMRR)

CMRR for the OPAx316-Q1 is specified in several ways so the user can select the best match for a given application, as shown in the [Electrical Characteristics](#) table. First, the data sheet gives the CMRR of the device in the common-mode range below the transition region [ $V_{CM} < (V+) - 1.4$  V]. This specification is the best indicator of device capability when the application requires use of one of the differential input pairs. Second, the CMRR over the entire common-mode range is specified at  $V_{CM} = -0.2$  V to 5.7 V for  $V_S = 5.5$  V. This last value includes the variations shown in [Figure 4](#) through the transition region.

### 7.3.5 EMI Susceptibility and Input Filtering

Operational amplifiers vary with regard to the susceptibility of the device to electromagnetic interference (EMI). If conducted EMI enters the operational amplifier, the dc offset observed at the amplifier output can shift from the nominal value when EMI is present. This shift is a result of signal rectification associated with the internal semiconductor junctions. Although EMI can affect all operational amplifier pin functions, the signal input pins are likely to be the most susceptible. The OPA316-Q1 operational amplifier family incorporates an internal input low-pass filter that reduces the amplifier response to EMI. This filter provides both common-mode and differential-mode filtering. The filter is designed for a cutoff frequency of approximately 80 MHz (–3 dB), with a roll-off of 20 dB per decade.

TI developed the ability to accurately measure and quantify the immunity of an operational amplifier over a broad frequency spectrum extending from 10 MHz to 6 GHz. The EMI rejection ratio (EMIRR) metric allows operational amplifiers to be directly compared by the EMI immunity. [Figure 35](#) illustrates the testing results on the OPAx316-Q1. For more information, see [EMI Rejection Ratio of Operational Amplifiers](#).

## Feature Description (continued)

### 7.3.6 Rail-to-Rail Output

Designed as a low-power, low-noise operational amplifier, the OPAx316-Q1 delivers a robust output drive capability. A class AB output stage with common-source transistors achieves full rail-to-rail output swing capability. For resistive loads of 10-k $\Omega$ , the output swings typically to within 30 mV of either supply rail regardless of the power-supply voltage applied. Different load conditions change the ability of the amplifier to swing close to the rails; see [Figure 11](#).

### 7.3.7 Capacitive Load and Stability

The OPAx316-Q1 is designed for applications where driving a capacitive load is required. As with all operational amplifiers, there may be specific instances where the OPAx316-Q1 can become unstable. The particular operational amplifier circuit configuration, layout, gain, and output loading are some of the factors to consider when establishing whether or not an amplifier is stable in operation. An operational amplifier in the unity-gain (1 V/V) buffer configuration that drives a capacitive load exhibits a greater tendency to be unstable than an amplifier operated at a higher noise gain. The capacitive load, in conjunction with the operational amplifier output resistance, creates a pole within the feedback loop that degrades the phase margin. The degradation of the phase margin increases as the capacitive loading increases. As a conservative best practice, designing for 25% overshoot (40° phase margin) provides improved stability over process variations. The equivalent series resistance (ESR) of some very-large capacitors ( $C_L$  with a value greater than 1  $\mu$ F) is sufficient to alter the phase characteristics in the feedback loop such that the amplifier remains stable. Increasing the amplifier closed-loop gain allows the amplifier to drive increasingly larger capacitance. This increased capability is evident when observing the overshoot response of the amplifier at higher voltage gains. See [Figure 24](#) ( $G = -1$  V/V) and [Figure 25](#) ( $G = 1$  V/V).

Inserting a small resistor (typically 10- $\Omega$  to 20- $\Omega$ ) can increase the capacitive load capability of the amplifier in a unity-gain configuration, as shown in [Figure 38](#). This resistor significantly reduces the overshoot and ringing associated with large capacitive loads. One possible problem with this technique, however, is that a voltage divider is created with the added series resistor and any resistor connected in parallel with the capacitive load. The voltage divider introduces a gain error at the output that reduces the output swing.

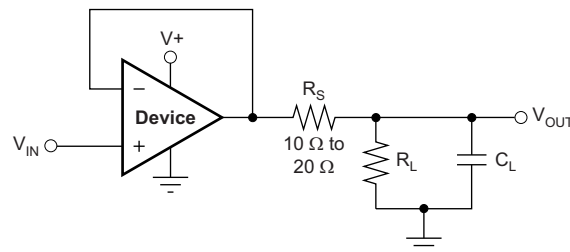

**Figure 38. Improving Capacitive Load Drive**

### 7.3.8 Overload Recovery

Overload recovery is defined as the time required for the operational amplifier output to recover from a saturated state to a linear state. The output devices of the operational amplifier enter a saturation region when the output voltage exceeds the rated operating voltage, either because of the high input voltage or the high gain. After the device enters the saturation region, the charge carriers in the output devices require time to return back to the linear state. After the charge carriers return back to the linear state, the device begins to slew at the specified slew rate. Thus, the propagation delay in case of an overload condition is the sum of the overload recovery time and the slew time. The overload recovery time for the OPAx316-Q1 is approximately 300 ns.

## 7.4 Device Functional Modes

The OPAx316-Q1 devices are powered on when the supply is connected. The devices can operate as a single-supply operational amplifier or a dual-supply amplifier, depending on the application.

## 8 Application and Implementation

### NOTE

Information in the following applications sections is not part of the TI component specification, and TI does not warrant its accuracy or completeness. TI's customers are responsible for determining suitability of components for their purposes. Customers should validate and test their design implementation to confirm system functionality.

### 8.1 Application Information

#### 8.1.1 General Configurations

When receiving low-level signals, the device often requires limiting the bandwidth of the incoming signals into the system. The simplest way to establish this limited bandwidth is to place an RC filter at the noninverting pin of the amplifier, as Figure 39 shows.

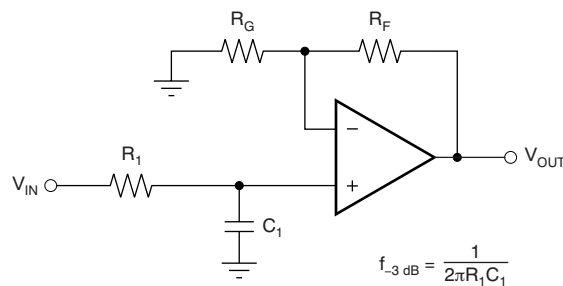

$$\frac{V_{OUT}}{V_{IN}} = \left(1 + \frac{R_F}{R_G}\right) \left(\frac{1}{1 + sR_1C_1}\right)$$

Figure 39. Single-Pole Low-Pass Filter

If even more attenuation is needed, the device requires a multiple-pole filter. The Sallen-Key filter can be used for this task, as Figure 40 shows. For best results, the amplifier must have a bandwidth that is eight to 10 times the filter frequency bandwidth. Failure to follow this guideline can result in phase shift of the amplifier.

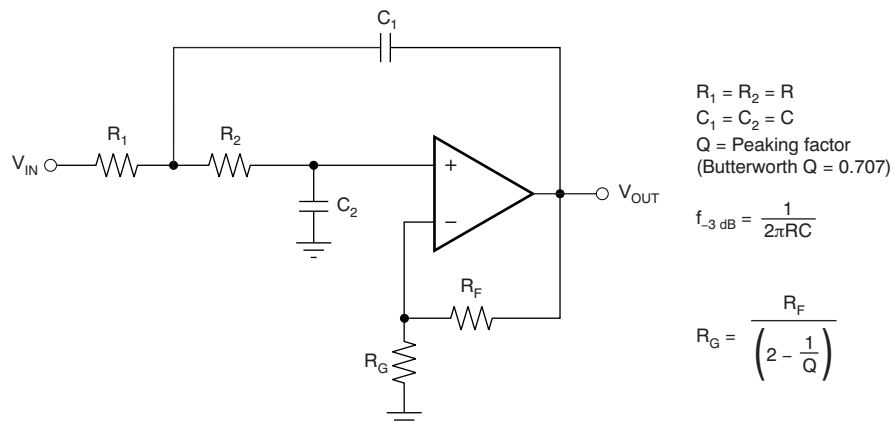
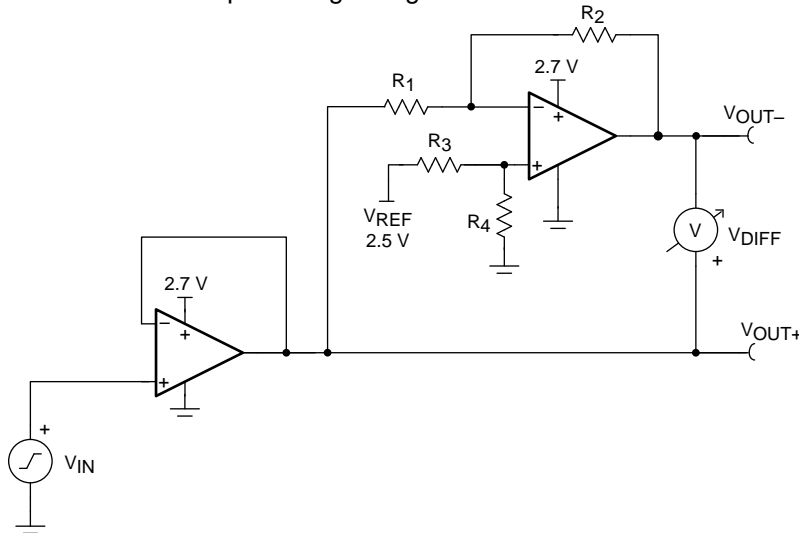

Figure 40. Two-Pole, Low-Pass, Sallen-Key Filter

## 8.2 Typical Application

Some applications require differential signals. [Figure 41](#) shows a simple circuit to convert a single-ended input of 0.1 V to 2.4 V into a differential output of  $\pm 2.3$  V on a single 2.7-V supply. The output range is intentionally limited to maximize linearity. The circuit is composed of two amplifiers. One amplifier functions as a buffer and creates a voltage ( $V_{OUT+}$ ). The second amplifier inverts the input and adds a reference voltage to generate  $V_{OUT-}$ .  $V_{OUT+}$  and  $V_{OUT-}$  range from 0.1 V to 2.4 V. The difference ( $V_{DIFF}$ ) is the difference between  $V_{OUT+}$  and  $V_{OUT-}$ , resulting in a differential output voltage range of 2.3 V.



**Figure 41. Schematic for a Single-Ended Input to Differential Output Conversion**

### 8.2.1 Design Requirements

[Table 1](#) lists the design requirements:

**Table 1. Design Parameters**

| DESIGN PARAMETER            | VALUE          |
|-----------------------------|----------------|
| Supply voltage              | 2.7 V          |
| Reference voltage           | 2.5 V          |
| Input voltage               | 0.1 V to 2.4 V |
| Output differential voltage | $\pm 2.3$ V    |
| Output common-mode voltage  | 1.25 V         |
| Small-signal bandwidth      | 5 MHz          |

### 8.2.2 Detailed Design Procedure

The circuit in [Figure 41](#) takes a single-ended input signal ( $V_{IN}$ ) and generates two output signals ( $V_{OUT+}$  and  $V_{OUT-}$ ) using two amplifiers and a reference voltage ( $V_{REF}$ ).  $V_{OUT+}$  is the output of the first amplifier and is a buffered version of the input signal ( $V_{IN}$ ), as shown in [Equation 1](#).  $V_{OUT-}$  is the output of the second amplifier that uses  $V_{REF}$  to add an offset voltage to  $V_{IN}$  and feedback to add inverting gain. The transfer function for  $V_{OUT-}$  is given in [Equation 2](#).

$$V_{OUT+} = V_{IN} \quad (1)$$

$$V_{OUT-} = V_{REF} \times \left( \frac{R_4}{R_3 + R_4} \right) \times \left( 1 + \frac{R_2}{R_1} \right) - V_{IN} \times \frac{R_2}{R_1} \quad (2)$$

The differential output signal ( $V_{\text{DIFF}}$ ) is the difference between the two single-ended output signals ( $V_{\text{OUT}+}$  and  $V_{\text{OUT}-}$ ). Equation 3 shows the transfer function for  $V_{\text{DIFF}}$ . Using conditions in Equation 4 and Equation 5 and applying the conditions that  $R_1 = R_2$  and  $R_3 = R_4$ , the transfer function is simplified into Equation 6. Using this configuration, the maximum input signal is equal to the reference voltage, and the maximum output of each amplifier is equal to  $V_{\text{REF}}$ . The differential output range is  $2 \times V_{\text{REF}}$ . Furthermore, the common-mode voltage is one half of  $V_{\text{REF}}$ , as shown in Equation 7.

$$V_{\text{DIFF}} = V_{\text{OUT}+} - V_{\text{OUT}-} = V_{\text{IN}} \times \left(1 + \frac{R_2}{R_1}\right) - V_{\text{REF}} \times \left(\frac{R_4}{R_3 + R_4}\right) \times \left(1 + \frac{R_2}{R_1}\right) \quad (3)$$

$$V_{\text{OUT}+} = V_{\text{IN}} \quad (4)$$

$$V_{\text{OUT}-} = V_{\text{REF}} - V_{\text{IN}} \quad (5)$$

$$V_{\text{DIFF}} = 2 \times V_{\text{IN}} - V_{\text{REF}} \quad (6)$$

$$V_{\text{CM}} = \left(\frac{V_{\text{OUT}+} + V_{\text{OUT}-}}{2}\right) = \frac{1}{2} V_{\text{REF}} \quad (7)$$

### 8.2.2.1 Amplifier Selection

Linearity over the input range is key for good dc accuracy. The common-mode input range and output swing limitations determine the linearity. In general, an amplifier with rail-to-rail input and output swing is required. Bandwidth is a key concern for this design, so the OPAx316-Q1 is selected because the bandwidth is greater than the target of 5 MHz. The bandwidth and power ratio makes this device power efficient and the low offset and drift ensure good accuracy for moderate precision applications.

### 8.2.2.2 Passive Component Selection

Because the transfer function of  $V_{\text{OUT}-}$  is heavily reliant on resistors ( $R_1$ ,  $R_2$ ,  $R_3$ , and  $R_4$ ), use resistors with low tolerances to maximize performance and minimize error. This design uses resistors with resistance values of 49.9-k $\Omega$  and tolerances of 0.1%. However, if the noise of the system is a key parameter, smaller resistance values (6-k $\Omega$  or lower) can be selected to keep the overall system noise low. This ensures that the noise from the resistors is lower than the amplifier noise.

### 8.2.3 Application Curves

The measured transfer functions in [Figure 42](#), [Figure 43](#), and [Figure 44](#) are generated by sweeping the input voltage from 0.1 V to 2.4 V. The full input range is actually 0 V to 2.5 V, but is restricted to 0.1 V to maintain optimal linearity. For more details on this design and other alternative devices that can be used in place of the OPAx316-Q1, see [Single-Ended Input to Differential Output Conversion Circuit Reference Design](#).

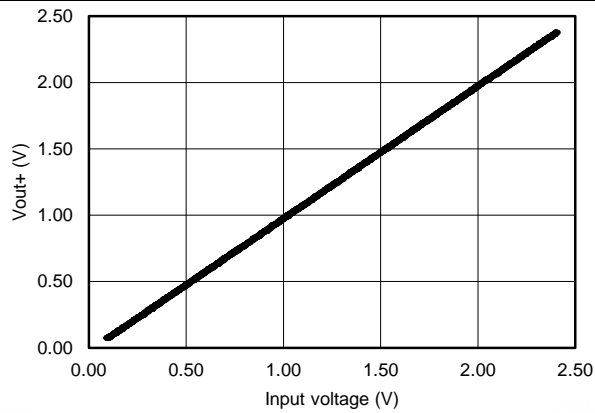

**Figure 42. V<sub>OUT+</sub> vs Input Voltage**

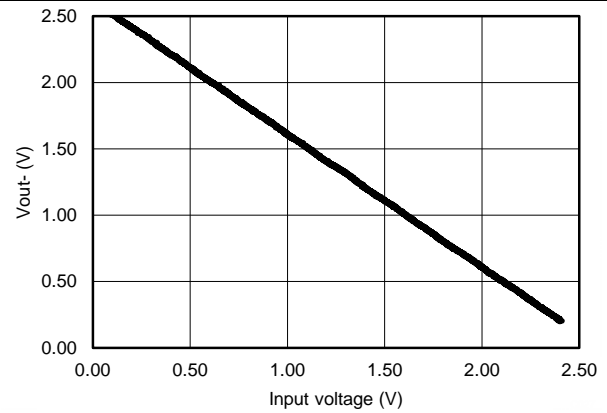

**Figure 43. V<sub>OUT-</sub> vs Input Voltage**

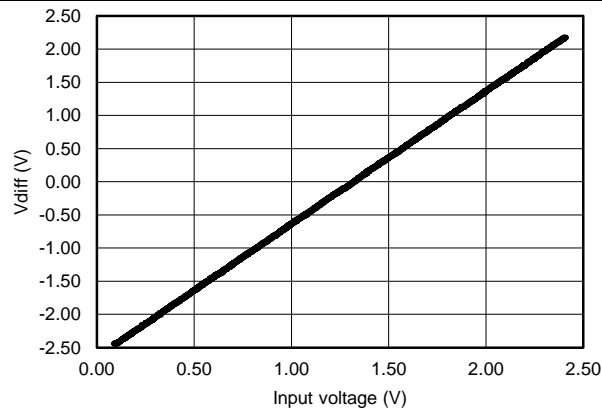

**Figure 44. V<sub>DIFF</sub> vs Input Voltage**

## 9 Power Supply Recommendations

The OPAx316-Q1 family is specified for operation from 1.8 V to 5.5 V ( $\pm 0.9$  V to  $\pm 2.75$  V); many specifications apply from  $-40^{\circ}\text{C}$  to  $+125^{\circ}\text{C}$ . The [Typical Characteristics](#) section presents parameters that can exhibit significant variance with regard to operating voltage or temperature.

### CAUTION

Supply voltages larger than 7 V can permanently damage the device; see the [Absolute Maximum Ratings](#) table.

Place 0.1- $\mu\text{F}$  bypass capacitors close to the power-supply pins to reduce errors coupling in from noisy or high-impedance power supplies. For more information on bypass capacitor placement, see the [Layout Guidelines](#) section.

## 10 Layout

### 10.1 Layout Guidelines

For best operational performance of the device, use good PCB layout practices, including:

- Noise can propagate into analog circuitry through the power pins of the circuit as a whole and the operational amplifier. Bypass capacitors reduce the coupled noise by providing low-impedance power sources local to the analog circuitry.
  - Connect low-ESR, 0.1- $\mu$ F ceramic bypass capacitors between each supply pin and ground, placed as close to the device as possible. A single bypass capacitor from V+ to ground is applicable for single-supply applications.
- Separate grounding for analog and digital portions of the circuitry is one of the simplest and most effective methods of noise suppression. One or more layers on multilayer PCBs are typically devoted to ground planes. A ground plane helps distribute heat and reduces EMI noise pickup. Take care to physically separate digital and analog grounds, paying attention to the flow of the ground current.
- To reduce parasitic coupling, run the input traces as far away from the supply or output traces as possible. If these traces cannot be kept separate, crossing the sensitive trace perpendicularly is much better than crossing in parallel with the noisy trace.
- Place the external components as close to the device as possible. Keeping  $R_F$  and  $R_G$  close to the inverting input minimizes parasitic capacitance, as shown in [Figure 45](#).
- Keep the length of input traces as short as possible. Remember that the input traces are the most sensitive part of the circuit.
- Consider a driven, low-impedance guard ring around the critical traces. A guard ring can significantly reduce leakage currents from nearby traces that are at different potentials.

### 10.2 Layout Example

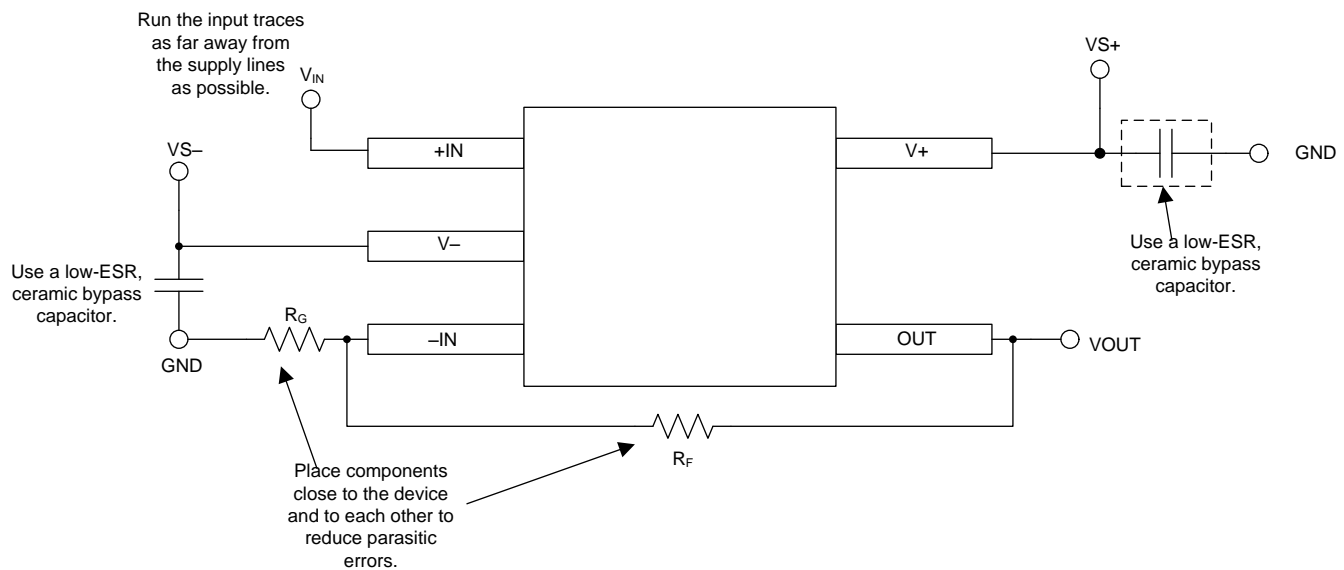

Copyright © 2016, Texas Instruments Incorporated

**Figure 45. Operational Amplifier Board Layout for Noninverting Configuration**

## 11 Device and Documentation Support

### 11.1 Documentation Support

#### 11.1.1 Related Documentation

For related documentation see the following:

- [EMI Rejection Ratio of Operational Amplifiers](#)
- [Single-Ended Input to Differential Output Conversion Circuit Reference Design](#)

#### 11.2 Related Links

[Table 2](#) lists quick access links. Categories include technical documents, support and community resources, tools and software, and quick access to sample or buy.

**Table 2. Related Links**

| PARTS      | PRODUCT FOLDER             | SAMPLE & BUY               | TECHNICAL DOCUMENTS        | TOOLS & SOFTWARE           | SUPPORT & COMMUNITY        |
|------------|----------------------------|----------------------------|----------------------------|----------------------------|----------------------------|
| OPA316-Q1  | <a href="#">Click here</a> | <a href="#">Click here</a> | <a href="#">Click here</a> | <a href="#">Click here</a> | <a href="#">Click here</a> |
| OPA2316-Q1 | <a href="#">Click here</a> | <a href="#">Click here</a> | <a href="#">Click here</a> | <a href="#">Click here</a> | <a href="#">Click here</a> |
| OPA4316-Q1 | <a href="#">Click here</a> | <a href="#">Click here</a> | <a href="#">Click here</a> | <a href="#">Click here</a> | <a href="#">Click here</a> |

#### 11.3 Receiving Notification of Documentation Updates

To receive notification of documentation updates, navigate to the device product folder on ti.com. In the upper right corner, click on *Alert me* to register and receive a weekly digest of any product information that has changed. For change details, review the revision history included in any revised document.

#### 11.4 Community Resources

The following links connect to TI community resources. Linked contents are provided "AS IS" by the respective contributors. They do not constitute TI specifications and do not necessarily reflect TI's views; see TI's [Terms of Use](#).

**TI E2E™ Online Community** *TI's Engineer-to-Engineer (E2E) Community*. Created to foster collaboration among engineers. At e2e.ti.com, you can ask questions, share knowledge, explore ideas and help solve problems with fellow engineers.

**Design Support** *TI's Design Support* Quickly find helpful E2E forums along with design support tools and contact information for technical support.

#### 11.5 Trademarks

E2E is a trademark of Texas Instruments.

#### 11.6 Electrostatic Discharge Caution



These devices have limited built-in ESD protection. The leads should be shorted together or the device placed in conductive foam during storage or handling to prevent electrostatic damage to the MOS gates.

#### 11.7 Glossary

[SLYZ022](#) — *TI Glossary*.

This glossary lists and explains terms, acronyms, and definitions.

## 12 Mechanical, Packaging, and Orderable Information

The following pages include mechanical, packaging, and orderable information. This information is the most current data available for the designated devices. This data is subject to change without notice and revision of this document. For browser-based versions of this data sheet, refer to the left-hand navigation.

**PACKAGING INFORMATION**

| Orderable Device | Status<br>(1) | Package Type | Package Drawing | Pins | Package Qty | Eco Plan<br>(2)         | Lead/Ball Finish<br>(6) | MSL Peak Temp<br>(3) | Op Temp (°C) | Device Marking<br>(4/5) | Samples                 |
|------------------|---------------|--------------|-----------------|------|-------------|-------------------------|-------------------------|----------------------|--------------|-------------------------|-------------------------|
| OPA2316QDQKQ1    | ACTIVE        | VSSOP        | DGK             | 8    | 80          | Green (RoHS & no Sb/Br) | NIPDAUAG                | Level-2-260C-1 YEAR  | -40 to 125   | 15E6                    | <a href="#">Samples</a> |
| OPA2316QDQKRQ1   | ACTIVE        | VSSOP        | DGK             | 8    | 2500        | Green (RoHS & no Sb/Br) | NIPDAUAG                | Level-2-260C-1 YEAR  | -40 to 125   | 15E6                    | <a href="#">Samples</a> |
| OPA316QDBVRQ1    | ACTIVE        | SOT-23       | DBV             | 5    | 3000        | Green (RoHS & no Sb/Br) | NIPDAU                  | Level-2-260C-1 YEAR  | -40 to 125   | 15AD                    | <a href="#">Samples</a> |
| OPA316QDBVTQ1    | ACTIVE        | SOT-23       | DBV             | 5    | 250         | Green (RoHS & no Sb/Br) | NIPDAU                  | Level-2-260C-1 YEAR  | -40 to 125   | 15AD                    | <a href="#">Samples</a> |
| OPA4316QPWRQ1    | ACTIVE        | TSSOP        | PW              | 14   | 2000        | Green (RoHS & no Sb/Br) | NIPDAU                  | Level-2-260C-1 YEAR  | -40 to 125   | 4316Q1                  | <a href="#">Samples</a> |

(1) The marketing status values are defined as follows:

**ACTIVE:** Product device recommended for new designs.

**LIFEBUY:** TI has announced that the device will be discontinued, and a lifetime-buy period is in effect.

**NRND:** Not recommended for new designs. Device is in production to support existing customers, but TI does not recommend using this part in a new design.

**PREVIEW:** Device has been announced but is not in production. Samples may or may not be available.

**OBSOLETE:** TI has discontinued the production of the device.

(2) **RoHS:** TI defines "RoHS" to mean semiconductor products that are compliant with the current EU RoHS requirements for all 10 RoHS substances, including the requirement that RoHS substance do not exceed 0.1% by weight in homogeneous materials. Where designed to be soldered at high temperatures, "RoHS" products are suitable for use in specified lead-free processes. TI may reference these types of products as "Pb-Free".

**RoHS Exempt:** TI defines "RoHS Exempt" to mean products that contain lead but are compliant with EU RoHS pursuant to a specific EU RoHS exemption.

**Green:** TI defines "Green" to mean the content of Chlorine (Cl) and Bromine (Br) based flame retardants meet JS709B low halogen requirements of <=1000ppm threshold. Antimony trioxide based flame retardants must also meet the <=1000ppm threshold requirement.

(3) MSL, Peak Temp. - The Moisture Sensitivity Level rating according to the JEDEC industry standard classifications, and peak solder temperature.

(4) There may be additional marking, which relates to the logo, the lot trace code information, or the environmental category on the device.

(5) Multiple Device Markings will be inside parentheses. Only one Device Marking contained in parentheses and separated by a "-" will appear on a device. If a line is indented then it is a continuation of the previous line and the two combined represent the entire Device Marking for that device.

(6) Lead/Ball Finish - Orderable Devices may have multiple material finish options. Finish options are separated by a vertical ruled line. Lead/Ball Finish values may wrap to two lines if the finish value exceeds the maximum column width.

**Important Information and Disclaimer:**The information provided on this page represents TI's knowledge and belief as of the date that it is provided. TI bases its knowledge and belief on information provided by third parties, and makes no representation or warranty as to the accuracy of such information. Efforts are underway to better integrate information from third parties. TI has taken and continues to take reasonable steps to provide representative and accurate information but may not have conducted destructive testing or chemical analysis on incoming materials and chemicals. TI and TI suppliers consider certain information to be proprietary, and thus CAS numbers and other limited information may not be available for release.

In no event shall TI's liability arising out of such information exceed the total purchase price of the TI part(s) at issue in this document sold by TI to Customer on an annual basis.

**OTHER QUALIFIED VERSIONS OF OPA2316-Q1, OPA316-Q1, OPA4316-Q1 :**

- Catalog: [OPA2316](#), [OPA316](#), [OPA4316](#)

NOTE: Qualified Version Definitions:

- Catalog - TI's standard catalog product

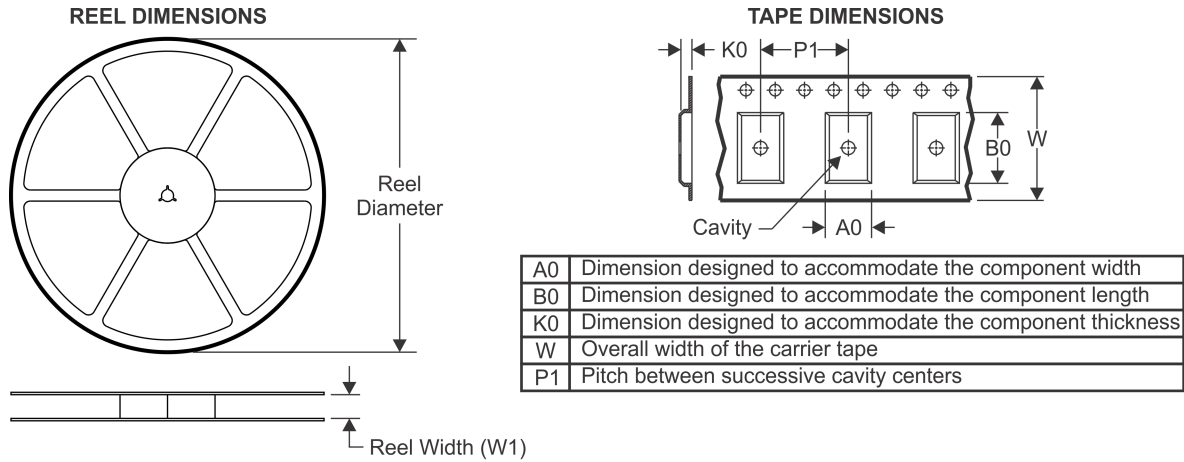
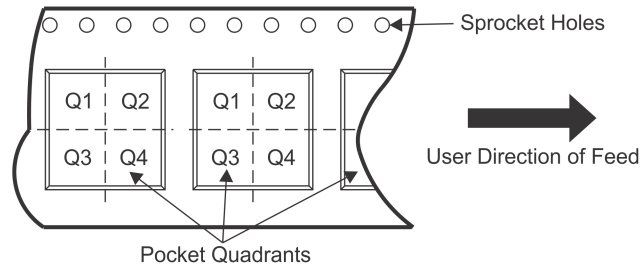
**TAPE AND REEL INFORMATION**

**QUADRANT ASSIGNMENTS FOR PIN 1 ORIENTATION IN TAPE**

\*All dimensions are nominal

| Device         | Package Type | Package Drawing | Pins | SPQ  | Reel Diameter (mm) | Reel Width W1 (mm) | A0 (mm) | B0 (mm) | K0 (mm) | P1 (mm) | W (mm) | Pin1 Quadrant |
|----------------|--------------|-----------------|------|------|--------------------|--------------------|---------|---------|---------|---------|--------|---------------|
| OPA2316QDGKRQ1 | VSSOP        | DGK             | 8    | 2500 | 330.0              | 12.4               | 5.3     | 3.4     | 1.4     | 8.0     | 12.0   | Q1            |
| OPA316QDBVRQ1  | SOT-23       | DBV             | 5    | 3000 | 178.0              | 9.0                | 3.3     | 3.2     | 1.4     | 4.0     | 8.0    | Q3            |
| OPA316QDBVTQ1  | SOT-23       | DBV             | 5    | 250  | 178.0              | 9.0                | 3.23    | 3.17    | 1.37    | 4.0     | 8.0    | Q3            |
| OPA4316QPWRQ1  | TSSOP        | PW              | 14   | 2000 | 330.0              | 12.4               | 6.9     | 5.6     | 1.6     | 8.0     | 12.0   | Q1            |

## TAPE AND REEL BOX DIMENSIONS



\*All dimensions are nominal

| Device         | Package Type | Package Drawing | Pins | SPQ  | Length (mm) | Width (mm) | Height (mm) |
|----------------|--------------|-----------------|------|------|-------------|------------|-------------|
| OPA2316QDGKRQ1 | VSSOP        | DGK             | 8    | 2500 | 366.0       | 364.0      | 50.0        |
| OPA316QDBVRQ1  | SOT-23       | DBV             | 5    | 3000 | 180.0       | 180.0      | 18.0        |
| OPA316QDBVTQ1  | SOT-23       | DBV             | 5    | 250  | 180.0       | 180.0      | 18.0        |
| OPA4316QPWRQ1  | TSSOP        | PW              | 14   | 2000 | 367.0       | 367.0      | 35.0        |



# EXAMPLE BOARD LAYOUT

DBV0005A

SOT-23 - 1.45 mm max height

SMALL OUTLINE TRANSISTOR

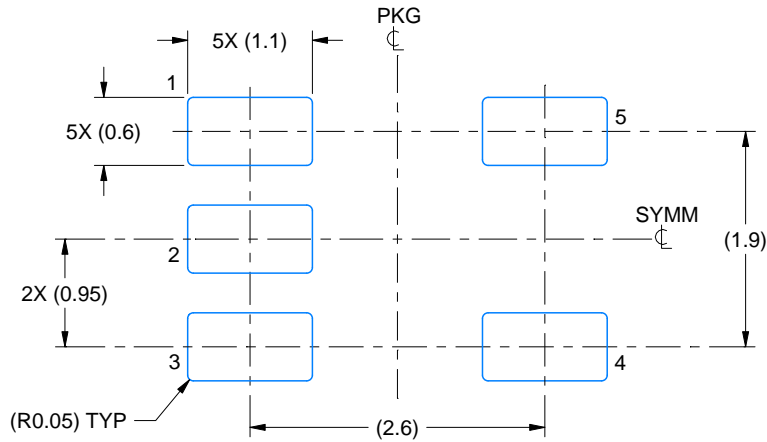

LAND PATTERN EXAMPLE  
EXPOSED METAL SHOWN  
SCALE:15X

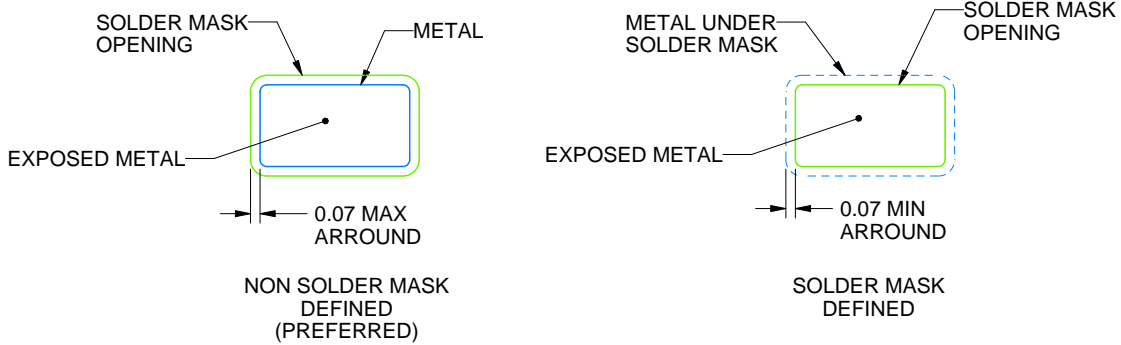

SOLDER MASK DETAILS

4214839/E 09/2019

NOTES: (continued)

- 5. Publication IPC-7351 may have alternate designs.
- 6. Solder mask tolerances between and around signal pads can vary based on board fabrication site.

# EXAMPLE STENCIL DESIGN

DBV0005A

SOT-23 - 1.45 mm max height

SMALL OUTLINE TRANSISTOR

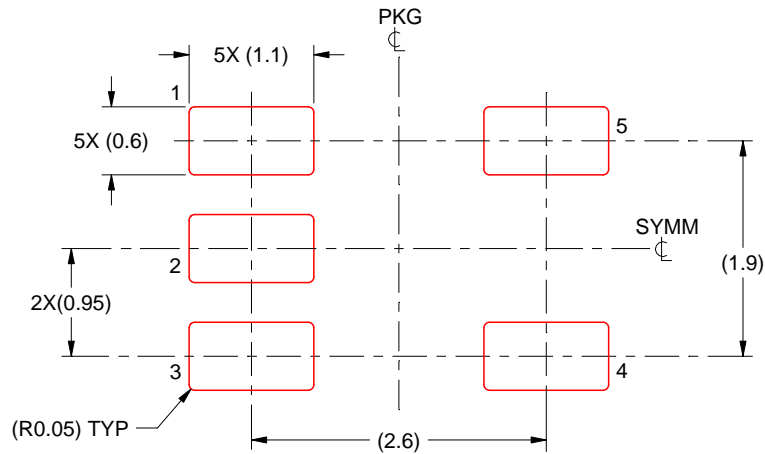

SOLDER PASTE EXAMPLE  
BASED ON 0.125 mm THICK STENCIL  
SCALE:15X

4214839/E 09/2019

NOTES: (continued)

7. Laser cutting apertures with trapezoidal walls and rounded corners may offer better paste release. IPC-7525 may have alternate design recommendations.
8. Board assembly site may have different recommendations for stencil design.



PW (R-PDSO-G14)

PLASTIC SMALL OUTLINE



4211284-2/G 08/15

- NOTES:
- All linear dimensions are in millimeters.
  - This drawing is subject to change without notice.
  - Publication IPC-7351 is recommended for alternate designs.
  - Laser cutting apertures with trapezoidal walls and also rounding corners will offer better paste release. Customers should contact their board assembly site for stencil design recommendations. Refer to IPC-7525 for other stencil recommendations.
  - Customers should contact their board fabrication site for solder mask tolerances between and around signal pads.





- NOTES:
- A. All linear dimensions are in millimeters.
  - B. This drawing is subject to change without notice.
  - C. Publication IPC-7351 is recommended for alternate designs.
  - D. Laser cutting apertures with trapezoidal walls and also rounding corners will offer better paste release. Customers should contact their board assembly site for stencil design recommendations. Refer to IPC-7525 for other stencil recommendations.
  - E. Customers should contact their board fabrication site for solder mask tolerances between and around signal pads.

## IMPORTANT NOTICE AND DISCLAIMER

TI PROVIDES TECHNICAL AND RELIABILITY DATA (INCLUDING DATASHEETS), DESIGN RESOURCES (INCLUDING REFERENCE DESIGNS), APPLICATION OR OTHER DESIGN ADVICE, WEB TOOLS, SAFETY INFORMATION, AND OTHER RESOURCES "AS IS" AND WITH ALL FAULTS, AND DISCLAIMS ALL WARRANTIES, EXPRESS AND IMPLIED, INCLUDING WITHOUT LIMITATION ANY IMPLIED WARRANTIES OF MERCHANTABILITY, FITNESS FOR A PARTICULAR PURPOSE OR NON-INFRINGEMENT OF THIRD PARTY INTELLECTUAL PROPERTY RIGHTS.

These resources are intended for skilled developers designing with TI products. You are solely responsible for (1) selecting the appropriate TI products for your application, (2) designing, validating and testing your application, and (3) ensuring your application meets applicable standards, and any other safety, security, or other requirements. These resources are subject to change without notice. TI grants you permission to use these resources only for development of an application that uses the TI products described in the resource. Other reproduction and display of these resources is prohibited. No license is granted to any other TI intellectual property right or to any third party intellectual property right. TI disclaims responsibility for, and you will fully indemnify TI and its representatives against, any claims, damages, costs, losses, and liabilities arising out of your use of these resources.

TI's products are provided subject to TI's Terms of Sale ([www.ti.com/legal/termsofsale.html](http://www.ti.com/legal/termsofsale.html)) or other applicable terms available either on [ti.com](http://ti.com) or provided in conjunction with such TI products. TI's provision of these resources does not expand or otherwise alter TI's applicable warranties or warranty disclaimers for TI products.

Mailing Address: Texas Instruments, Post Office Box 655303, Dallas, Texas 75265  
Copyright © 2020, Texas Instruments Incorporated