



ON Semiconductor®

AUTOMOTIVE ADAS PREREGULATOR STR-ADAS-PREREGULATOR-GEVK Test Report



Introduction

The Strata Assisted STR-ADAS-PREREGULATOR-GEVK provides an evaluation kit for the NCV881930 Synch Buck Controller and for the NCV6357 configurable 5.0 A Adaptive-On-Time (AOT) Step Down Converter a with I2C programmable output voltage from 0.6 V to 3.3 V in 12.5 mV steps. The NCV6357 also offers multiple operating modes: PFM for low load, Pseudo-PWM (PWM) for medium to high load, and forced PPWM which can be set by the operator. The evaluation kit is rated for automotive applications. This evaluation kit can be used in tandem with the Strata environment GUI to enable/disable the DC-DC converter, change the operating mode, and monitor other telemetry including interrupts, input/output voltage, power dissipated, and temperature.

Features

- Vin range from 6.0 .. 16.0 V, 40.0 V peak
 - Output 1 5.0 V @ 10.0 A peak
 - NCV881930 Synchronous Buck Controller + NVMF55C460NL 40 V Dual N-FET
 - Output 2 3.3 V @ 5.0 A peak
 - NCV6357MTWDTXG Step Down Converter, AOT, Configurable 5.0 A
- NCV6357MTWDTXG Programmable Vout from 0.6V to 3.3V in 12.5mV steps
- NCV6357MTWDTXG Adaptive-On-Time (AOT)
- NCV6357MTWDTXG Operation at up to 2.4MHz switching frequency
- NCV6357MTWDTXG Both PFM and PPWM operation with automatic transition for Optimum Efficiency
- NCV6357MTWDTXG 3.0 x 4.0 mm DFN-14 package
- Automotive and industrial rated AEC-Q100 Qualified and PPAP Capable

Applications

- DC-DC Power
- Advanced driver-assistance systems (ADAS).
- Automotive POL
- Instrumentation

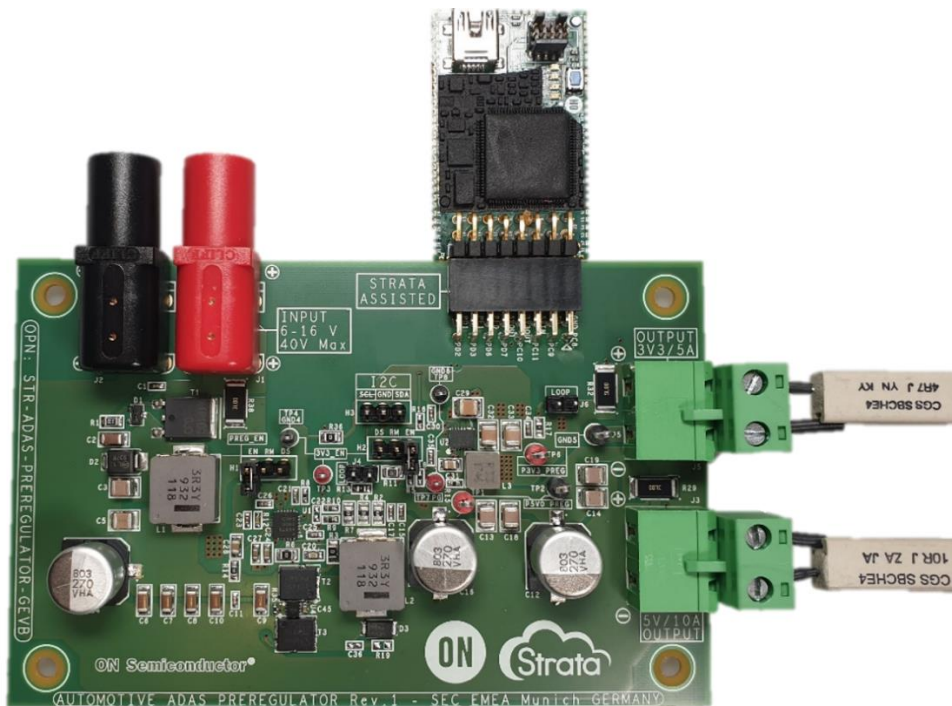

Test Report

This section will report important results and measurements from testing the **Strata Assisted STR-ADAS-PREREGULATOR-**.

1. Startup & Shutdown

The startup waveform at 12.0 V input voltage and no load is shown as follows:

Channel C1 **12.0 V Input Voltage**
2 V/div, 2 ms/div

Channel C2 **5.0 V Output Voltage**
2 V/div, 2 ms/div

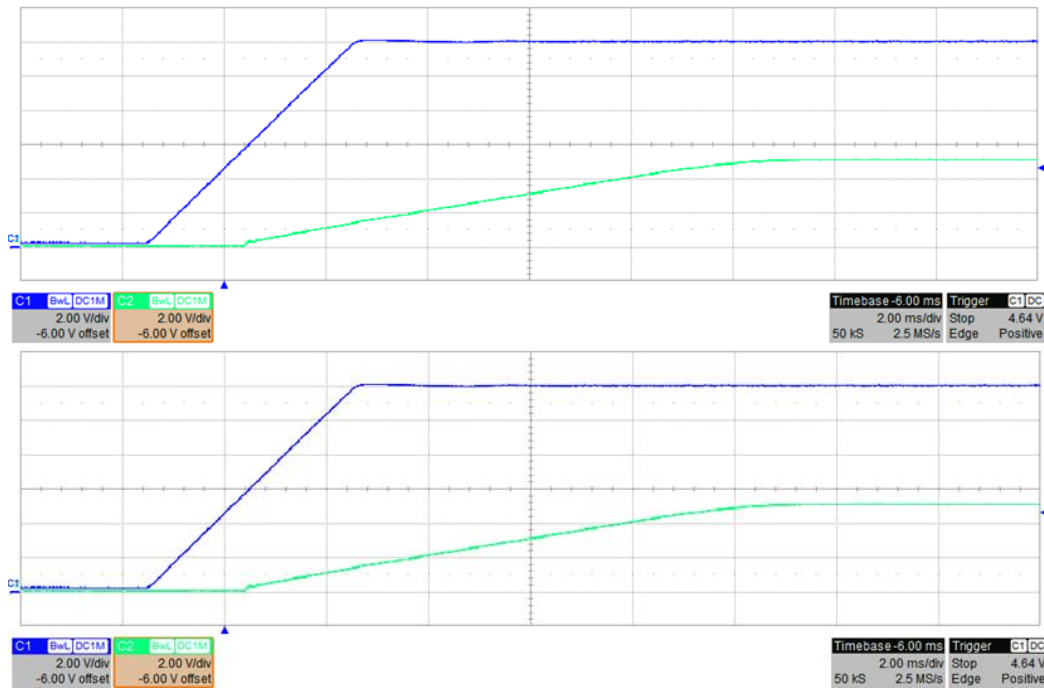

Figure 1

The shutdown waveform at 12.0 V input voltage and 6.0 A load is shown in

Figure 2.

Channel C1 **12.0 V Input Voltage**
2 V/div, 1 ms/div

Channel C1 **5.0 V Output Voltage**
2 V/div, 1 ms/div

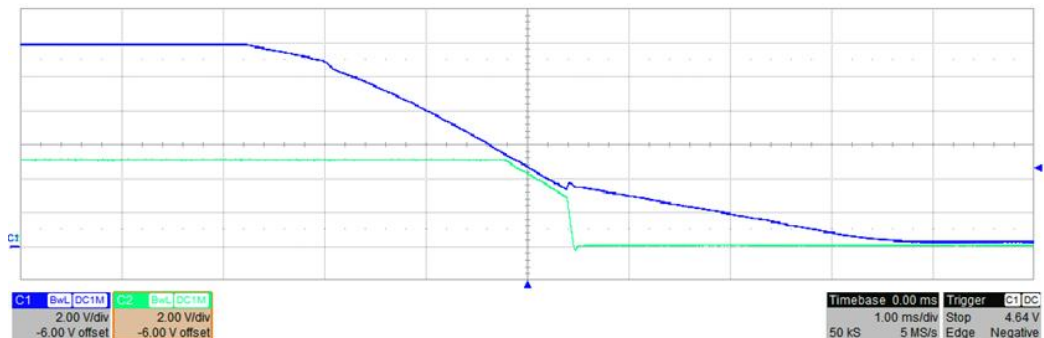

Figure 2

2. Efficiency

The efficiency and load regulation for **continuous synchronous mode** are shown in Figure 3 and Figure 4. **This measurement take into account the losses of the input filter.** VCCEXT is connected to VOUT.

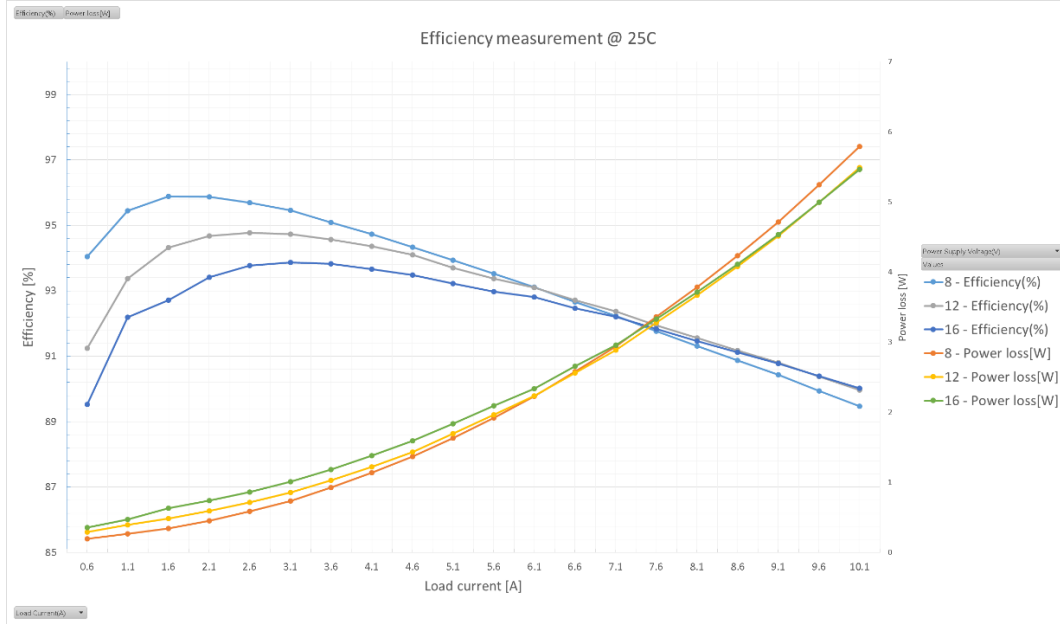

Figure 3

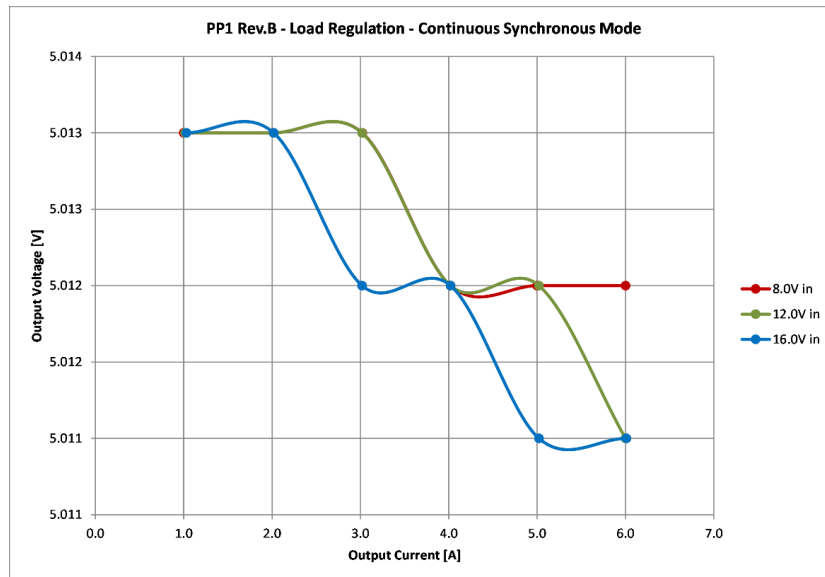

Figure 4

AUTOMOTIVE ADAS PREREGULATOR STR-ADAS-PREREGULATOR-GEVK

The efficiency and load regulation for **low I_q mode** are shown in Figure 5 and Figure 6. This measurement doesn't take into account the losses of the input filter.

VCCEXT is connected to VOUT.

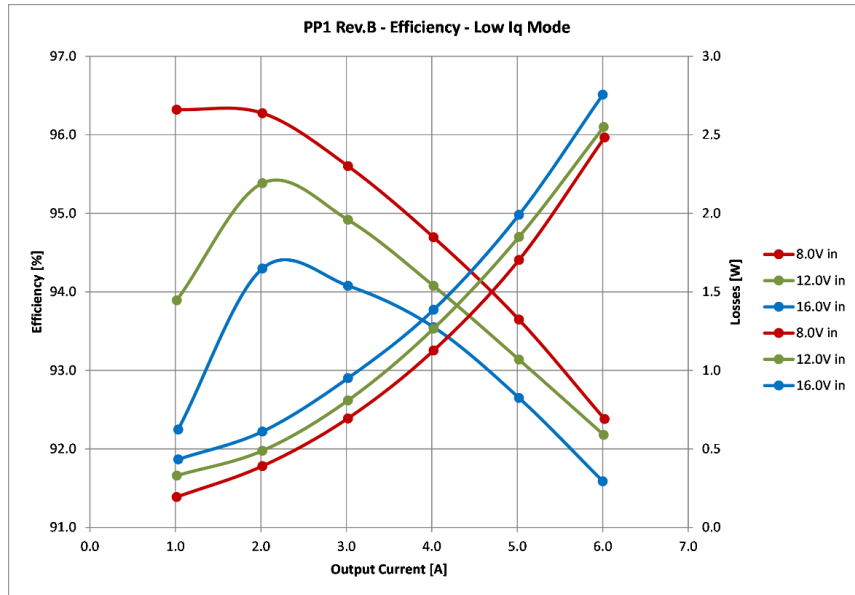

Figure 5

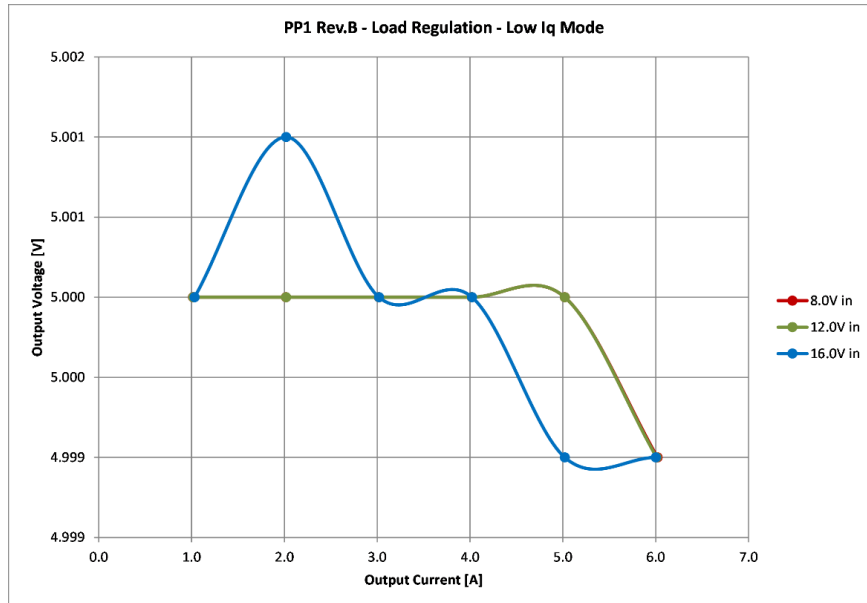

Figure 6

3. Transient Response

The response to a load step at 12.0 V input voltage is shown in Figure 7.

Channel C1 **Output Current**, Load Step 3.0 A to 6.0 A
2 A/div, 1 ms/div

Channel C2 **Output Voltage**, -111 mV undershoot (2.3 %), 112 mV overshoot (2.3 %)
100 mV/div, 1 ms/div, AC coupled

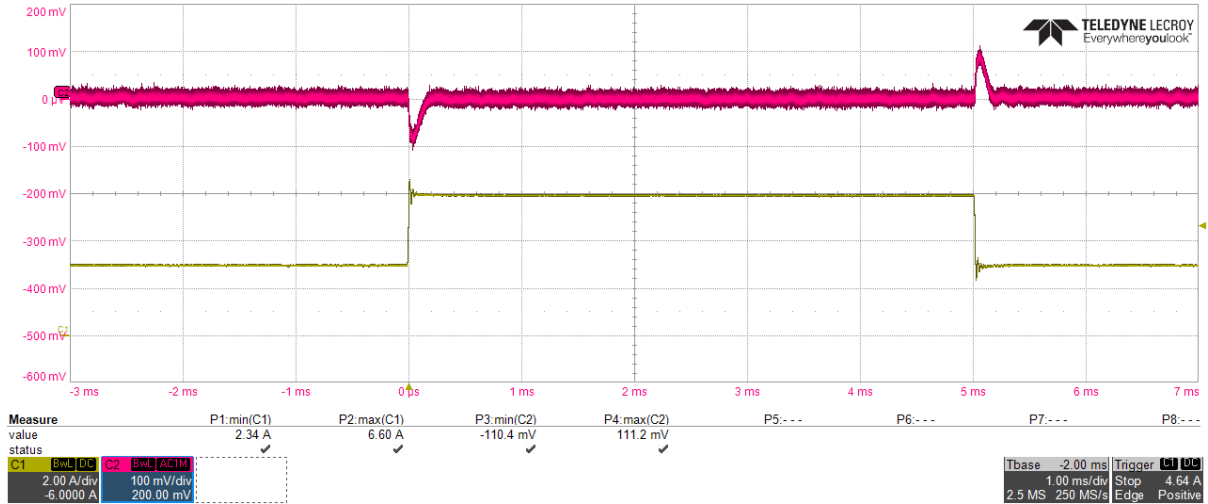

Figure 7

4. Frequency Response

The frequency response at 12.0 V input voltage and 6.0 A load is shown in Figure 8.

19.7 kHz bandwidth, 81 deg phase margin, -19 dB gain margin

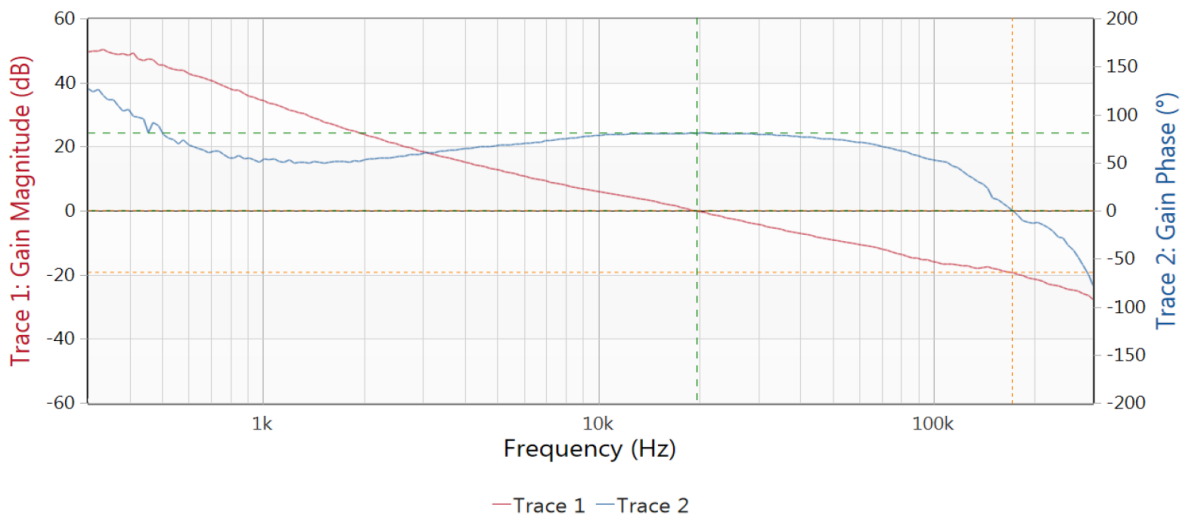

Figure 8

5. Input Ripple

The ripple voltage on C2 (connector) at 12.0 V input voltage and 6.0 A load is shown in

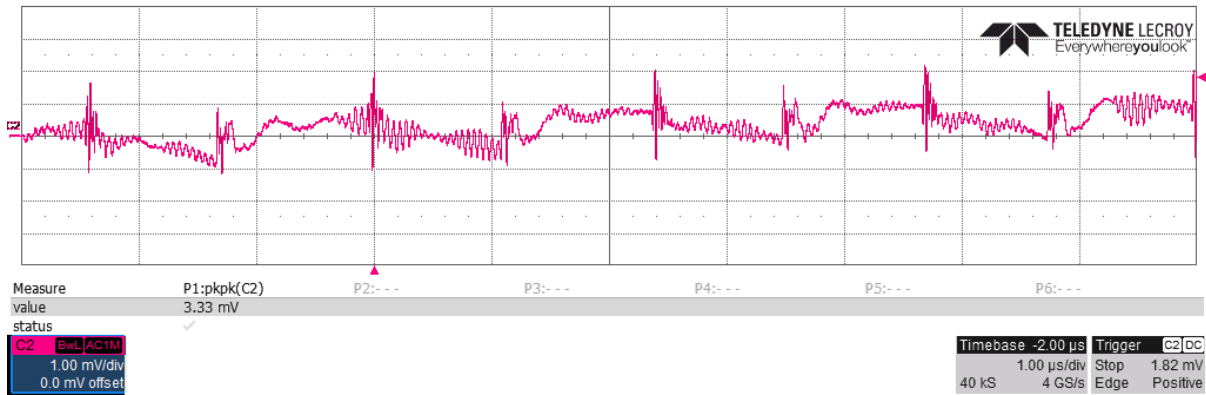

Figure 9.

Channel C2 **Input Voltage**, 1.1 mV peak-peak (0.01 %) ripple, 3.3 mV peak-peak (0.03 %) spikes
2 mV/div, 1 us/div, AC coupled

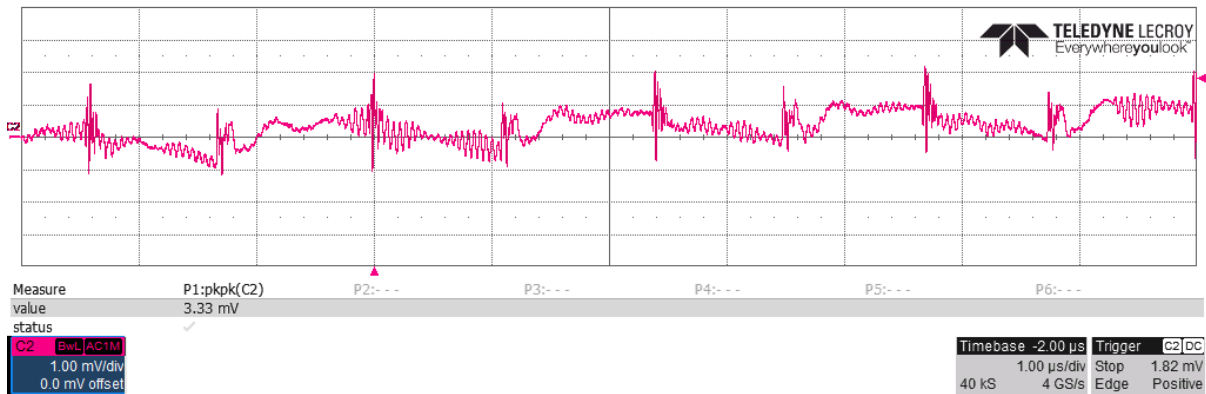

Figure 9

The ripple voltage on C1 (C9 on current board) (buck input) at 12.0 V input voltage and 6.0 A load is shown in

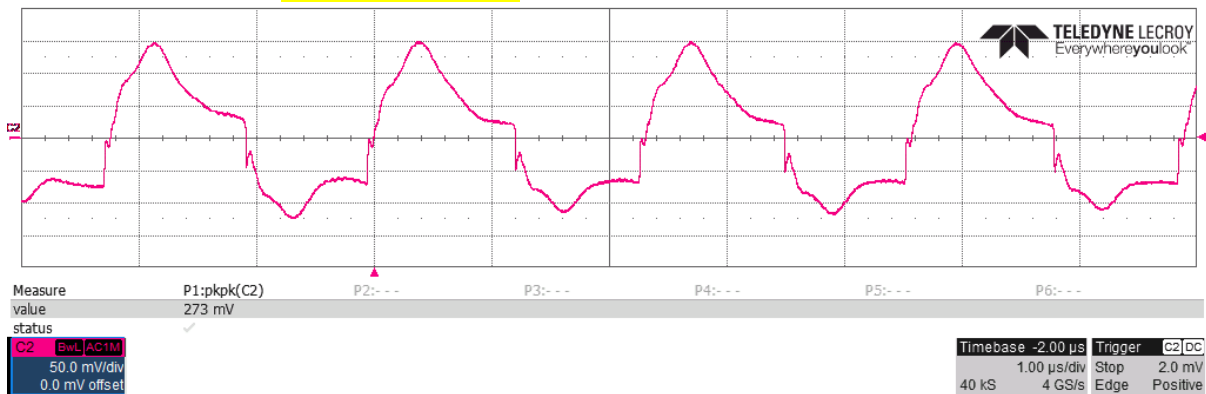

Figure 10.

Channel C2 **Input Voltage**, 270 mV peak-peak (2.3 %)
50 mV/div, 1 us/div, AC coupled

AUTOMOTIVE ADAS PREREGULATOR STR-ADAS-PREREGULATOR-GEVK

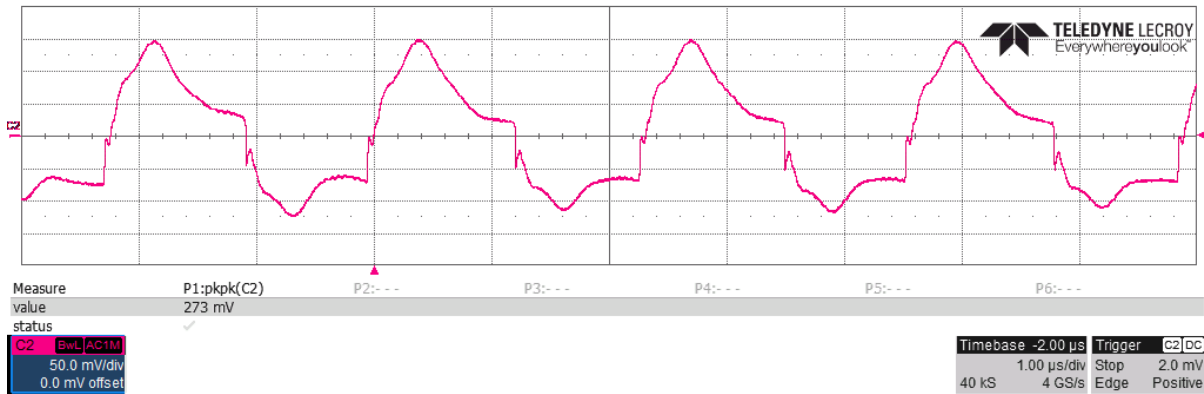

Figure 10

6. Output Ripple

The output ripple (at C13) voltage 12.0 V input voltage and 6.0 A load is shown in Figure 11.

Channel C2 **Output Voltage**, 12 mV peak-peak (0.3 %) ripple, 25 mV peak-peak (0.5 %) spikes
5 mV/div, 1 us/div, AC coupled

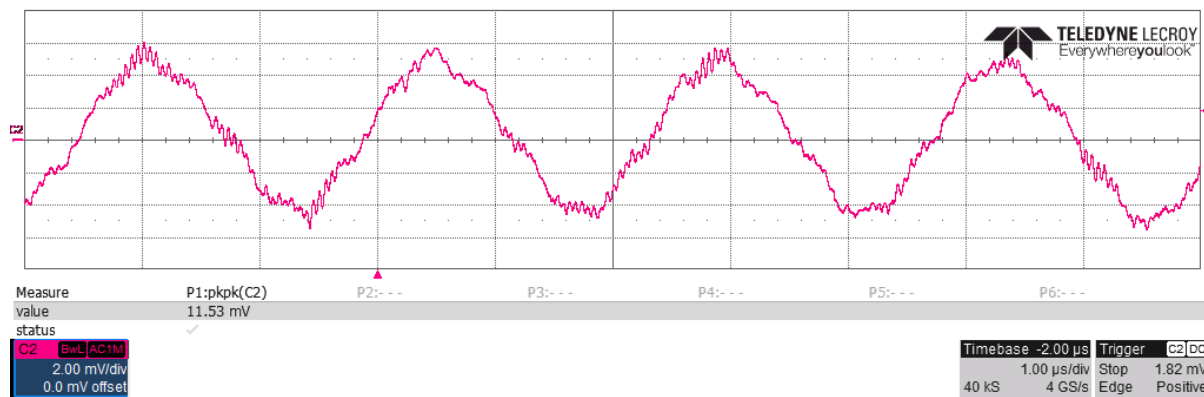

Figure 11

7. Low-Side FET (Switching Node)

The drain-source voltage of the low-side FET at 12.0V input voltage and 6.0A load is shown in Figure 12.

Channel C2 **Drain-Source Voltage**, -2.2 V minimum, 12.7 V maximum
5 V/div, 500 ns/div

AUTOMOTIVE ADAS PREREGULATOR STR-ADAS-PREREGULATOR-GEVK

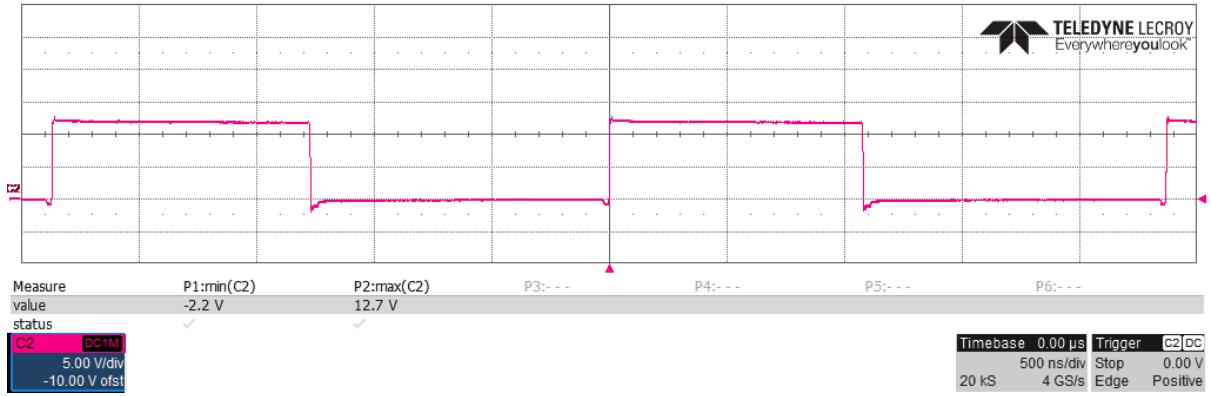

Figure 12

8. Thermal Image

The thermal image (Figure 13) shows the circuit at an ambient temperature of 24 °C with an input voltage of 12.0 V and 5.0 A load.

FET Q1: 51 °C, Inductor L2: 49 °C

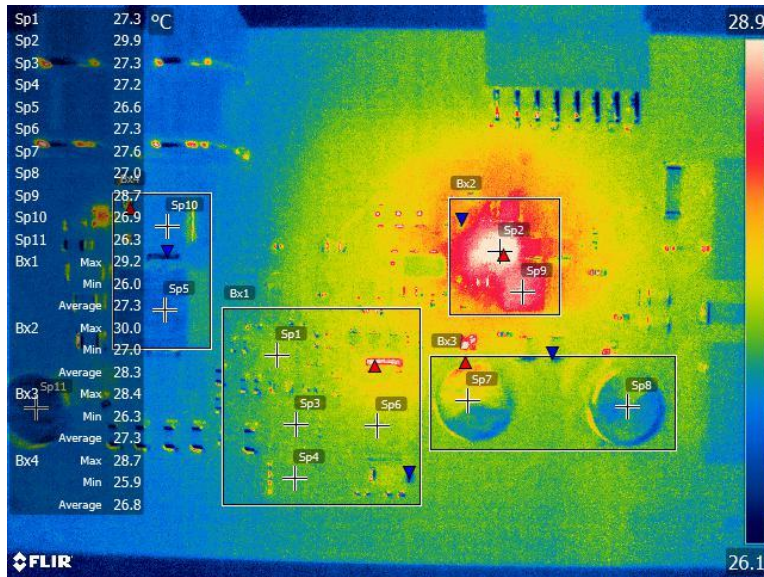

Figure 13

The thermal image (Figure 14) shows the circuit at an ambient temperature of 24 °C with an input voltage of 12.0 V and 10.0 A load.

FET Q1: 110 °C, Inductor L2: 101 °C

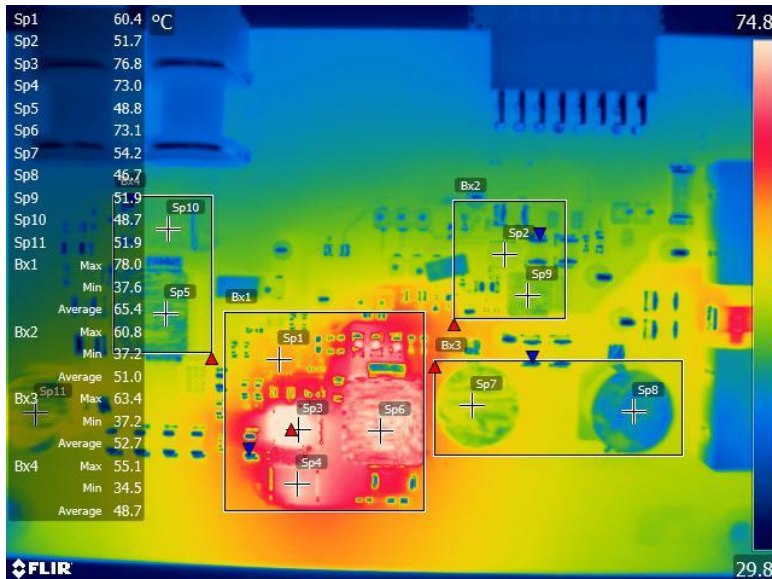

Figure 14

9. Schematic

Figure 15a

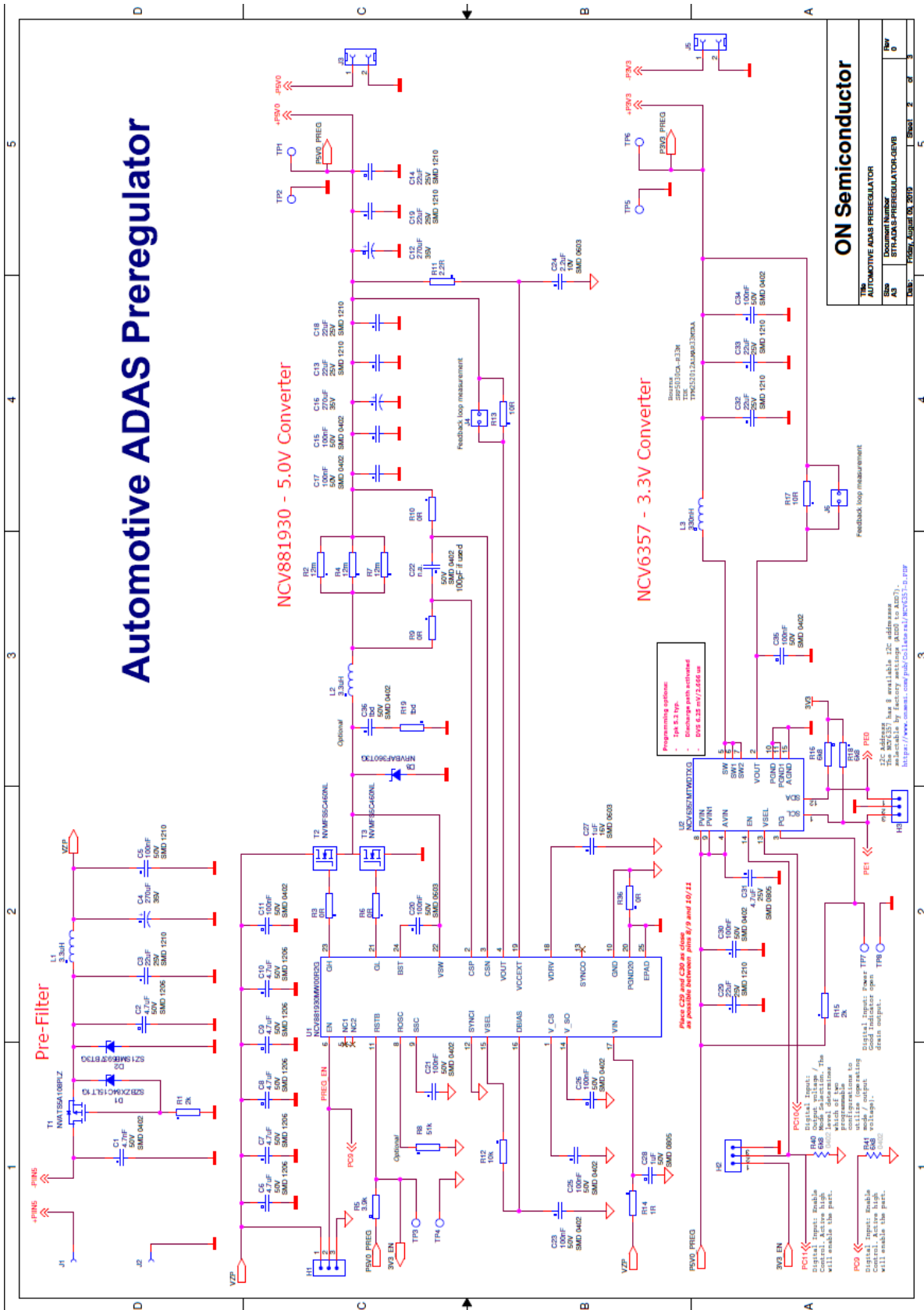
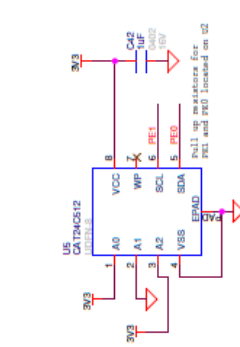
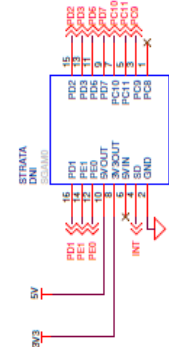

Figure 16b

Strata Assisted

Strata Assisted Connection Circuit



Comment: A0, A1, and A2 depending on type of PCB
 slave address
 000 - 0x50 - General purpose
 001 - 0x51 - Reserved
 010 - 0x52 - Reserved
 011 - 0x53 - Reserved
 100 - 0x54 - Reserved
 101 - 0x55 - Middle (I2C/C) - slave Addressed board
 110 - 0x56 - Middle (I2C/C) - slave Addressed board
 111 - 0x57 - Strata only (JLT board)

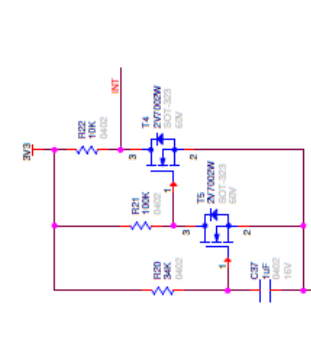

Slave 100 on JLT board
 504, 100 = Slave negative pull
 System can also mask INT for JLT board interrupt
 Pull-up of 10k for the Strata pin INT enable

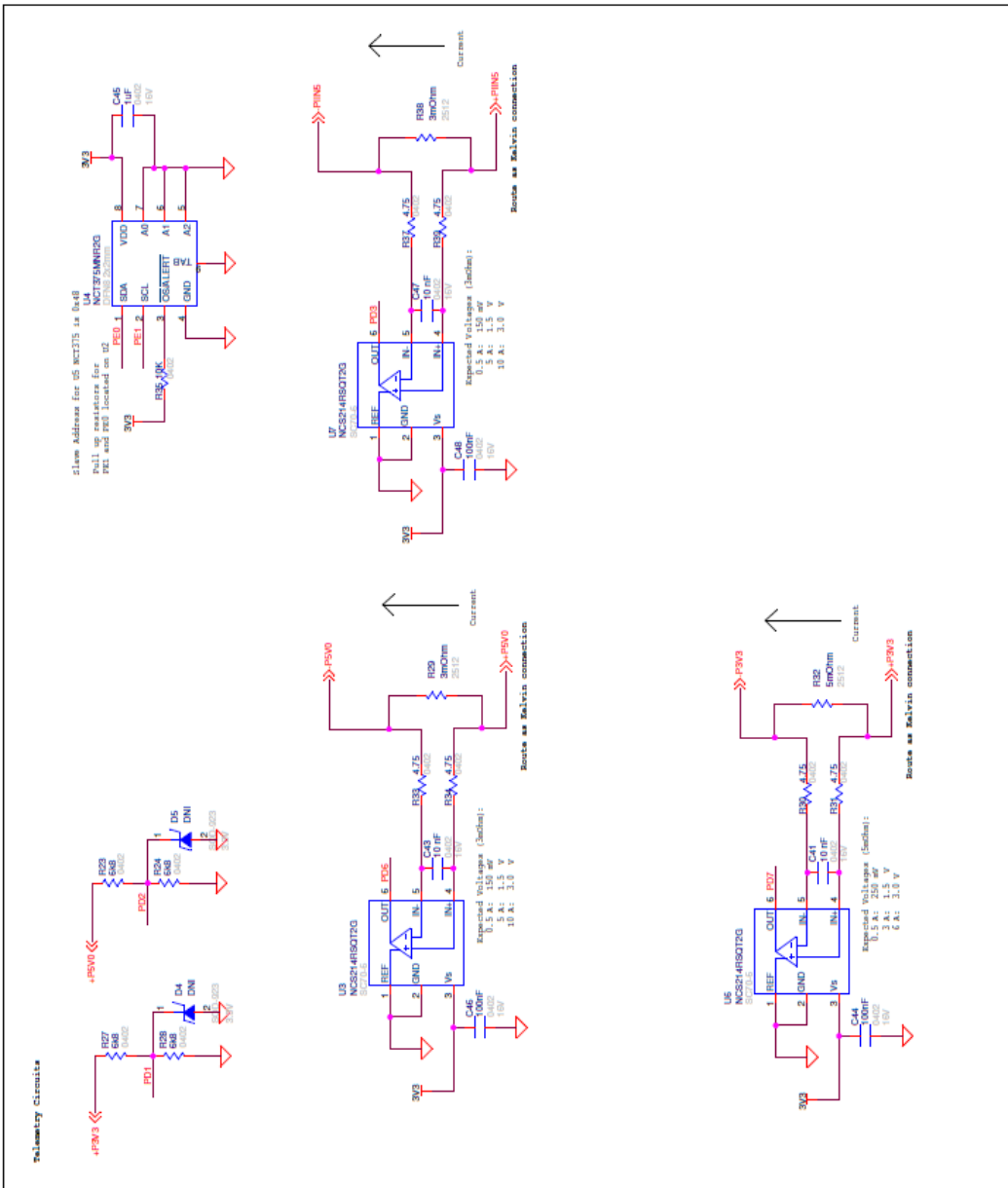

ON Semiconductor		
THE	AUTOMOTIVE ADAS PREREGULATOR	
Docu	STR-ADAS-PREREGULATOR-GEVK	
Rev	2	
Doc	Monday, August 12, 2019	Sheet 3 of 3

ON Semiconductor and are trademarks of Semiconductor Components Industries, LLC dba ON Semiconductor or its subsidiaries in the United States and/or other countries. ON Semiconductor owns the rights to a number of patents, trademarks, copyrights, trade secrets, and other intellectual property. A listing of ON Semiconductor's product/patent coverage may be accessed at <https://www.onsemi.com/site/pdf/Patent-Marking.pdf>. ON Semiconductor reserves the right to make changes without further notice to any products herein. ON Semiconductor makes no warranty, representation or guarantee regarding the suitability of its products for any particular purpose, nor does ON Semiconductor assume any liability arising out of the application or use of any product or circuit, and specifically disclaims any and all liability, including without limitation special, consequential or incidental damages. Buyer is responsible for its products and applications using ON Semiconductor products, including compliance with all laws, regulations and safety requirements or standards, regardless of any support or applications information provided by ON Semiconductor. "Typical" parameters which may be provided in ON Semiconductor data sheets and/or specifications can and do vary in different applications and actual performance may vary over time. All operating parameters, including "Typicals" must be validated for each customer application by customer's technical experts. ON Semiconductor does not convey any license under its patent rights nor the rights of others. If the product is to be used as a critical component in life support systems, or any FDA Class 3 medical devices or medical devices with a similar or equivalent classification in a foreign jurisdiction, or any devices intended for implantation in the human body, sale is subject to ON Semiconductor's advance written authorization for product use and a separate indemnification agreement signed by Buyer. ON Semiconductor is an Equal Opportunity/Affirmative Action Employer. This literature is subject to all applicable copyright laws and is not for resale in any manner.

PUBLICATION ORDERING INFORMATION

LITERATURE FULLFILLMENT:

Literature Distribution Center for ON Semiconductor 19521 E.
32nd Pkwy, Aurora, Colorado 80011 USA

Phone: 303-675-2175 or 800-344-3860 Toll Free USA/Canada
Fax: 303-675-2176 or 800-344-3867 Toll Free USA/Canada
Email: orderlit@onsemi.com

N. American Technical Support:

800-282-9855 Toll Free USA/Canada

Europe, Middle East and Africa Technical Support:

Phone: 421 33 790 2910

ON Semiconductor Website:

<https://www.onsemi.com/>

Order Literature:

<https://www.onsemi.com/orderlit>

For additional information, please contact your local
Sales Representative

AUTOMOTIVE ADAS PREREGULATOR STR-ADAS-PREREGULATOR-GEVK

ON Semiconductor and the ON Semiconductor logo are trademarks of Semiconductor Components Industries, LLC dba ON Semiconductor or its subsidiaries in the United States and/or other countries. ON Semiconductor owns the rights to a number of patents, trademarks, copyrights, trade secrets, and other intellectual property. A listing of ON Semiconductor's product/patent coverage may be accessed at www.onsemi.com/site/pdf/Patent-Marking.pdf. ON Semiconductor is an Equal Opportunity/Affirmative Action Employer. This literature is subject to all applicable copyright laws and is not for resale in any manner.

The evaluation board/kit (research and development board/kit) (hereinafter the "board") is not a finished product and is as such not available for sale to consumers. The board is only intended for research, development, demonstration and evaluation purposes and should as such only be used in laboratory/development areas by persons with an engineering/technical training and familiar with the risks associated with handling electrical/mechanical components, systems and subsystems. This person assumes full responsibility/liability for proper and safe handling. Any other use, resale or redistribution for any other purpose is strictly prohibited.

The board is delivered "AS IS" and without warranty of any kind including, but not limited to, that the board is production-worthy, that the functions contained in the board will meet your requirements, or that the operation of the board will be uninterrupted or error free. ON Semiconductor expressly disclaims all warranties, express, implied or otherwise, including without limitation, warranties of fitness for a particular purpose and non-infringement of intellectual property rights.

ON Semiconductor reserves the right to make changes without further notice to any board.

You are responsible for determining whether the board will be suitable for your intended use or application or will achieve your intended results. Prior to using or distributing any systems that have been evaluated, designed or tested using the board, you agree to test and validate your design to confirm the functionality for your application. Any technical, applications or design information or advice, quality characterization, reliability data or other services provided by ON Semiconductor shall not constitute any representation or warranty by ON Semiconductor, and no additional obligations or liabilities shall arise from ON Semiconductor having provided such information or services.

The boards are not designed, intended, or authorized for use in life support systems, or any FDA Class 3 medical devices or medical devices with a similar or equivalent classification in a foreign jurisdiction, or any devices intended for implantation in the human body. Should you purchase or use the board for any such unintended or unauthorized application, you shall indemnify and hold ON Semiconductor and its officers, employees, subsidiaries, affiliates, and distributors harmless against all claims, costs, damages, and expenses, and reasonable attorney fees arising out of, directly or indirectly, any claim of personal injury or death associated with such unintended or unauthorized use, even if such claim alleges that ON Semiconductor was negligent regarding the design or manufacture of the board.

This evaluation board/kit does not fall within the scope of the European Union directives regarding electromagnetic compatibility, restricted substances (RoHS), recycling (WEEE), FCC, CE or UL, and may not meet the technical requirements of these or other related directives.

FCC WARNING – This evaluation board/kit is intended for use for engineering development, demonstration, or evaluation purposes only and is not considered by ON Semiconductor to be a finished end product fit for general consumer use. It may generate, use, or radiate radio frequency energy and has not been tested for compliance with the limits of computing devices pursuant to part 15 of FCC rules, which are designed to provide reasonable protection against radio frequency interference. Operation of this equipment may cause interference with radio communications, in which case the user shall be responsible, at its expense, to take whatever measures may be required to correct this interference.

ON Semiconductor does not convey any license under its patent rights nor the rights of others.

LIMITATIONS OF LIABILITY: ON Semiconductor shall not be liable for any special, consequential, incidental, indirect or punitive damages, including, but not limited to the costs of requalification, delay, loss of profits or goodwill, arising out of or in connection with the board, even if ON Semiconductor is advised of the possibility of such damages. In no event shall ON Semiconductor's aggregate liability from any obligation arising out of or in connection with the board, under any theory of liability, exceed the purchase price paid for the board, if any.

PUBLICATION ORDERING INFORMATION

LITERATURE FULLFILLMENT:

Literature Distribution Center for ON Semiconductor 19521 E.
32nd Pkwy, Aurora, Colorado 80011 USA

Phone: 303-675-2175 or 800-344-3860 Toll Free USA/Canada

Fax: 303-675-2176 or 800-344-3867 Toll Free USA/Canada

Email: orderlit@onsemi.com

N. American Technical Support:

800-282-9855 Toll Free USA/Canada

Europe, Middle East and Africa Technical Support:

Phone: 421 33 790 2910

ON Semiconductor Website:

<https://www.onsemi.com/>

Order Literature:

<https://www.onsemi.com/orderlit>

For additional information, please contact your local Sales Representative