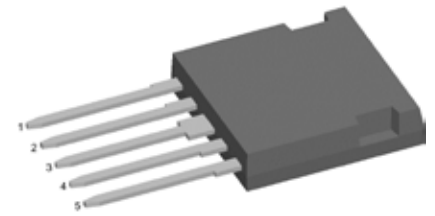
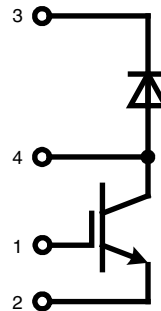

IGBT Boost Chopper

in ISOPLUS i4-PAC™

 $I_{C25} = 65 \text{ A}$
 $V_{CES} = 600 \text{ V}$
 $V_{CE(sat) \text{ typ.}} = 1.6 \text{ V}$

E72873

IGBT						
Symbol	Conditions	Maximum Ratings				
V_{CES}	$T_{VJ} = 25^{\circ}\text{C to } 150^{\circ}\text{C}$	600	V			
V_{GES}		± 20	V			
I_{C25}	$T_C = 25^{\circ}\text{C}$	65	A			
I_{C90}	$T_C = 90^{\circ}\text{C}$	40	A			
I_{CM}	$V_{GE} = \pm 15 \text{ V}; R_G = 22 \Omega; T_{VJ} = 125^{\circ}\text{C}$	100	A			
V_{CEK}	RBSOA Clamped inductive load; $L = 100 \mu\text{H}$	V_{CES}				
t_{SC} (SCSOA)	$V_{CE} = V_{CES}; V_{GE} = \pm 15 \text{ V}; R_G = 22 \Omega$ $T_{VJ} = 125^{\circ}\text{C}; \text{non-repetitive}$	10	μs			
P_{tot}	$T_C = 25^{\circ}\text{C}$	200	W			
Symbol	Conditions	Characteristic Values				
($T_{VJ} = 25^{\circ}\text{C}$, unless otherwise specified)						
		min.	typ.	max.		
$V_{CE(sat)}$	$I_C = 30 \text{ A}; V_{GE} = 15 \text{ V}$		1.6	2.0	V	
			1.8		V	
$V_{GE(th)}$	$I_C = 1 \text{ mA}; V_{GE} = V_{GE}$	4.5		6.5	V	
I_{CES}	$V_{CE} = V_{CES}; V_{GE} = 0 \text{ V}$		0.1	0.1	mA	
					mA	
I_{GES}	$V_{CE} = 0 \text{ V}; V_{GE} = \pm 20 \text{ V}$			200	nA	
$t_{d(on)}$	Inductive load $V_{CE} = 300 \text{ V}; I_C = 30 \text{ A}$ $V_{GE} = \pm 15 \text{ V}; R_G = 22 \Omega$ $T_{VJ} = 125^{\circ}\text{C}$		50		ns	
t_r			60		ns	
$t_{d(off)}$			300		ns	
t_f			30		ns	
E_{on}				1.0		mJ
E_{off}				1.4		mJ
C_{ies}	$V_{CE} = 25 \text{ V}; V_{GE} = 0 \text{ V}; f = 1 \text{ MHz}$		2.8		nF	
Q_{Gon}	$V_{CE} = 300 \text{ V}; V_{GE} = 15 \text{ V}; I_C = 50 \text{ A}$		120		nC	
R_{thJC}				0.6	K/W	
R_{thJH}	with heatsink compound		1.2		K/W	

Features

- NPT IGBT technology
 - low saturation voltage with positive temperature coefficient
 - fast switching
 - wide safe operating area
- HiPerFRED™ diode
 - fast reverse recovery
 - low operating forward voltage
 - low leakage current
- ISOPLUS i4-PAC™ package
 - isolated back surface
 - low coupling capacity between pins and heatsink
 - enlarged creepage towards heatsink
 - application friendly pinout
 - low inductive current path
 - high reliability
 - industry standard outline
 - UL registered E 72873

Applications

- medium frequency power supplies
 - boost chopper for power factor correction
 - transformer primary switch
- drives: supply of
 - switched reluctance machines
 - armature or excitation winding of DC machines
 - excitation winding of synchronous machines

Diode			
Symbol	Conditions	Maximum Ratings	
V_{RRM}	$T_{VJ} = 25^{\circ}\text{C}$ to 150°C	600	V
I_{F25}	$T_C = 25^{\circ}\text{C}$	52	A
I_{F90}	$T_C = 90^{\circ}\text{C}$	31	A

Symbol	Conditions	Characteristic Values			
		min.	typ.	max.	
V_F	$I_F = 30\text{ A}$	$T_{VJ} = 25^{\circ}\text{C}$	2.2	2.6	V
		$T_{VJ} = 125^{\circ}\text{C}$	1.5		V
I_R	$V_R = V_{RRM}$	$T_{VJ} = 25^{\circ}\text{C}$	0.3	0.3	mA
		$T_{VJ} = 125^{\circ}\text{C}$			mA
I_{RM}	$I_F = 30\text{ A}; di_F/dt = -500\text{ A}/\mu\text{s};$ $V_R = 300\text{ V}; V_{GE} = 0\text{ V};$	$T_{VJ} = 125^{\circ}\text{C}$	15		A
t_{tr}			70		ns
R_{thJC}	with heatsink compound		1.3		K/W
R_{thJH}		2.6		K/W	

Component			
Symbol	Conditions	Maximum Ratings	
T_{VJ}	operating	-55...+150	$^{\circ}\text{C}$
T_{stg}		-55...+125	$^{\circ}\text{C}$
V_{ISOL}	$I_{ISOL} \leq 1\text{ mA}; 50/60\text{ Hz}; t = 1\text{ s}$	2500	V~
F_C	Mounting force with clip	20...120	Nm

Symbol	Conditions	Characteristic Values			
		min.	typ.	max.	
C_P	coupling capacity between shorted pins and mounting tab in the case		40		pF
d_S, d_A	pin - pin	1.7			mm
d_S, d_A	pin - backside metal	5.5			mm
Weight			6		g

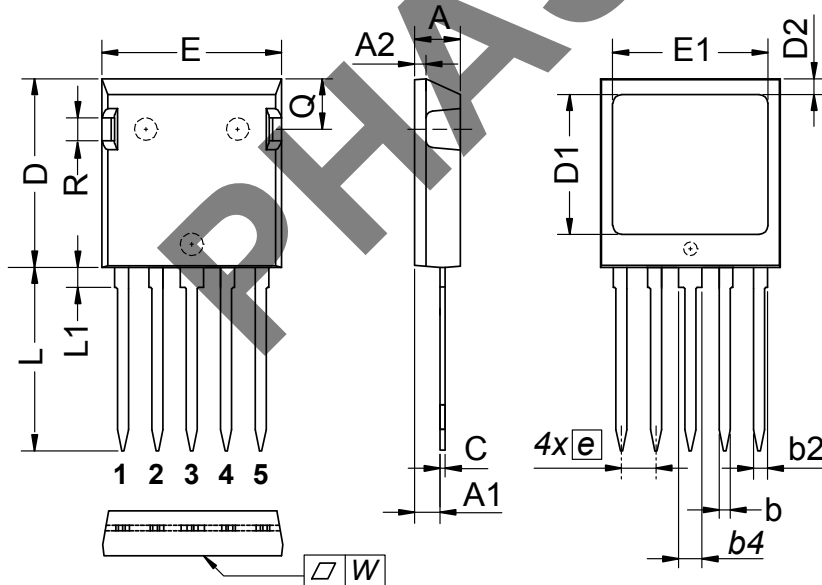

DIM.	MILLIMETER		INCHES	
	MIN	MAX	MIN	MAX
A	4.83	5.21	0.190	0.205
A1	2.59	3.00	0.102	0.118
A2	1.17	2.16	0.046	0.085
b	1.14	1.40	0.045	0.055
b2	1.47	1.73	0.058	0.068
b4	2.54	2.79	0.100	0.110
C	0.51	0.74	0.020	0.029
D	20.80	21.34	0.819	0.840
D1	14.99	15.75	0.590	0.620
D2	1.65	2.03	0.065	0.080
E	19.56	20.29	0.770	0.799
E1	16.76	17.53	0.660	0.690
e	3.81 BSC		0.15 BSC	
L	19.81	21.34	0.780	0.840
L1	2.11	2.59	0.083	0.102
Q	5.33	6.20	0.210	0.244
R	2.54	4.57	0.100	0.180
W	—	0.10	—	0.004

Die konvexe Form des Substrates ist typ. < 0.05 mm über der Kunststoffoberfläche der Bauteilunterseite
 The convex bow of substrate is typ. < 0.05 mm over plastic surface level of device bottom side

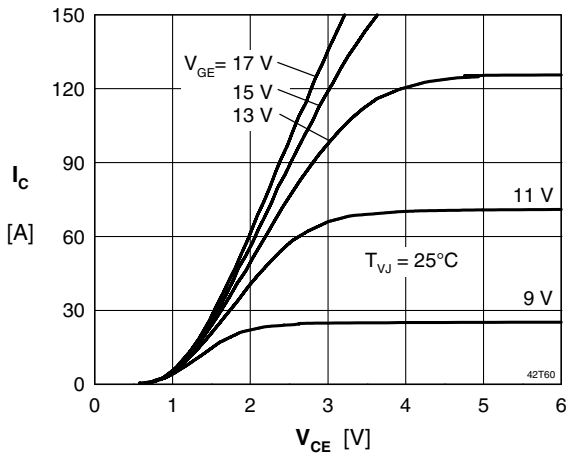

Fig. 1 Typ. output characteristics

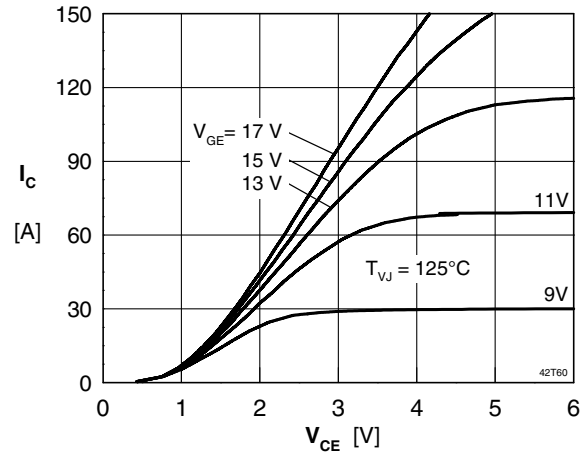

Fig. 2 Typ. output characteristics

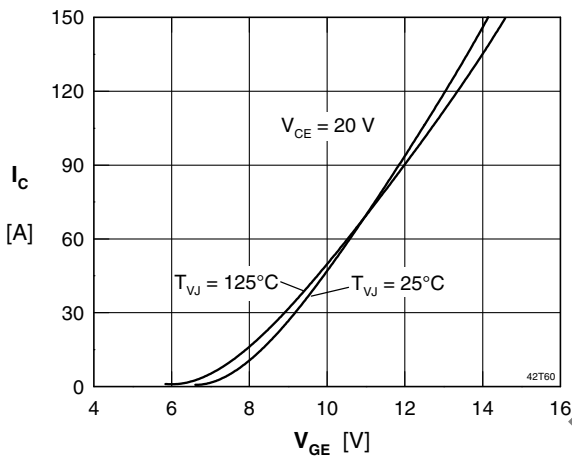

Fig. 3 Typ. transfer characteristics

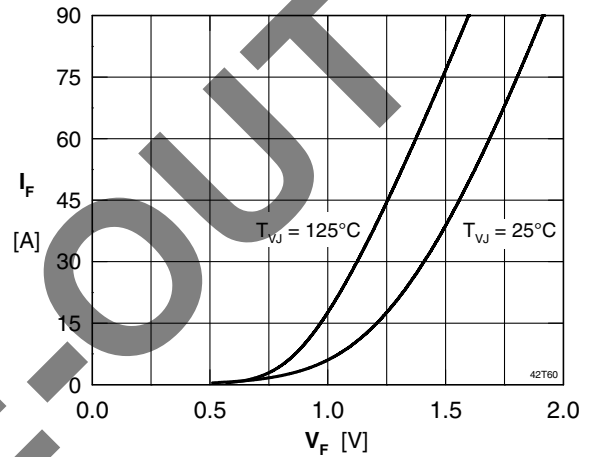

Fig. 4 Typ. forward characteristics of free wheeling diode

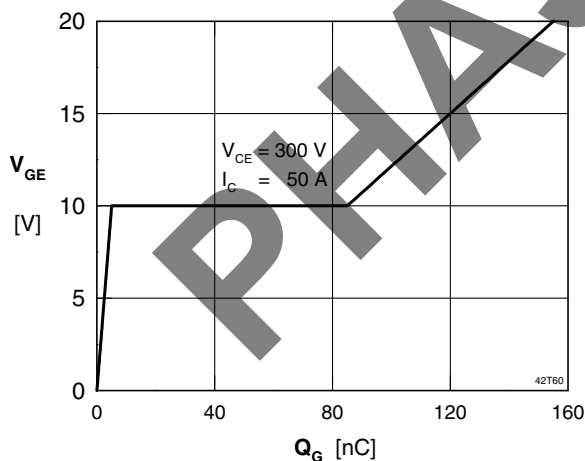

Fig. 5 Typ. turn on gate charge

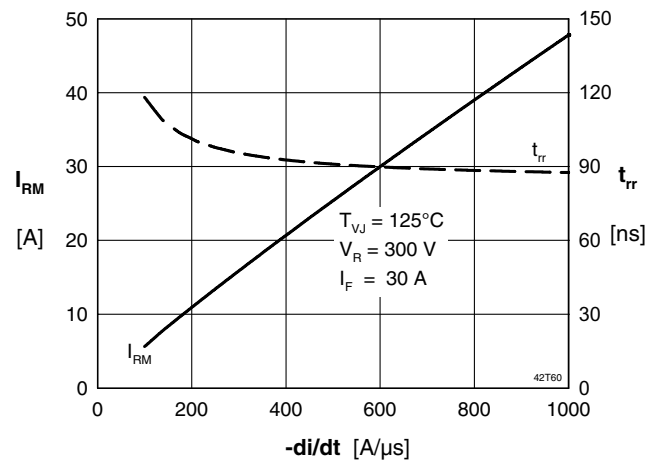

Fig. 6 Typ. turn off characteristics of free wheeling diode

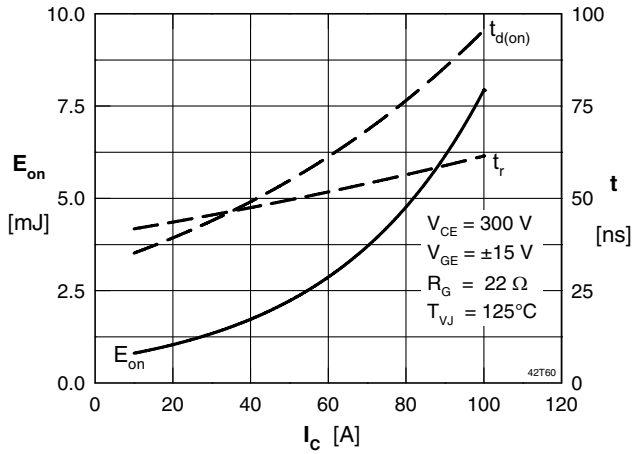

Fig. 7 Typ. turn on energy and switching

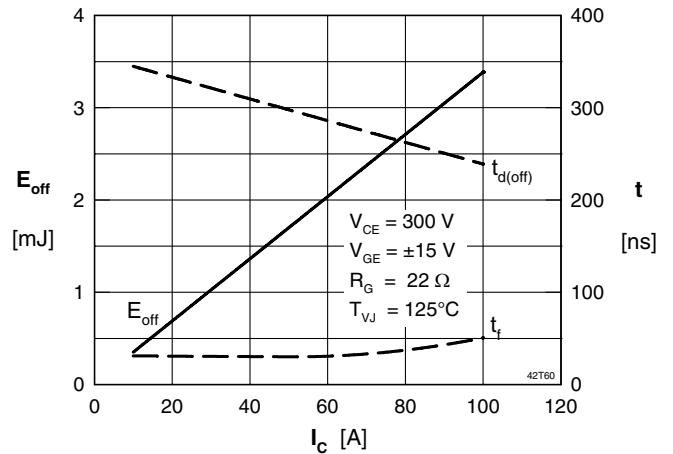

Fig. 8 Typ. turn off energy and switching times versus collector current times versus collector current

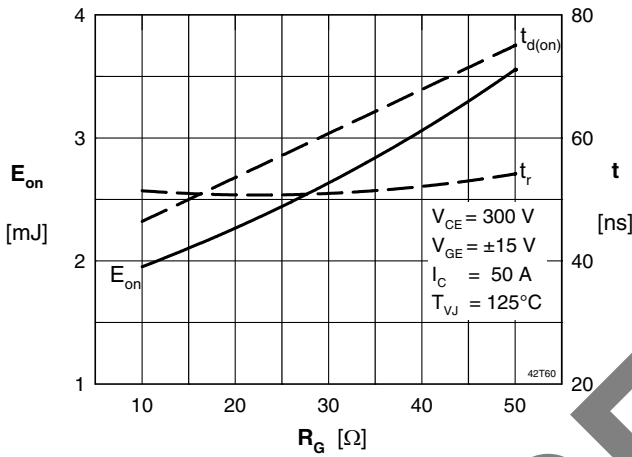

Fig. 9 Typ. turn on energy and switching

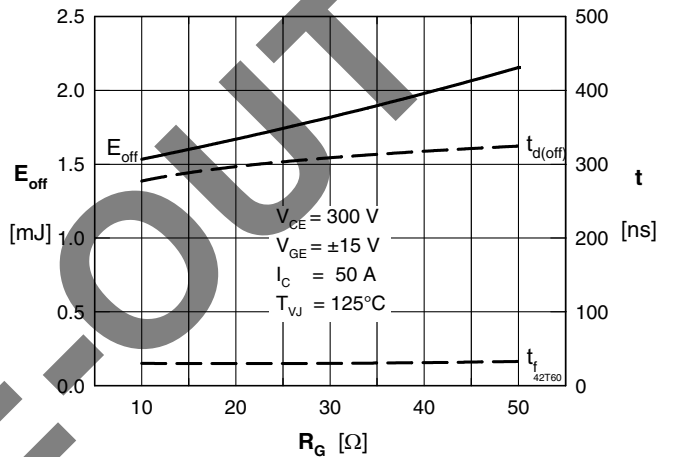

Fig. 10 Typ. turn off energy and switching times versus gate resistor times versus gate resistor

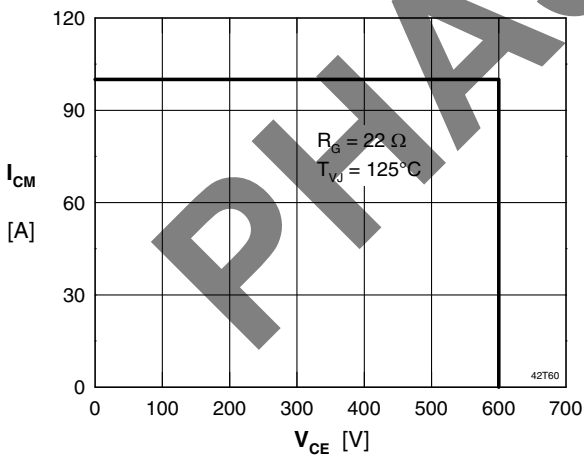

Fig. 11 Reverse biased safe operating area

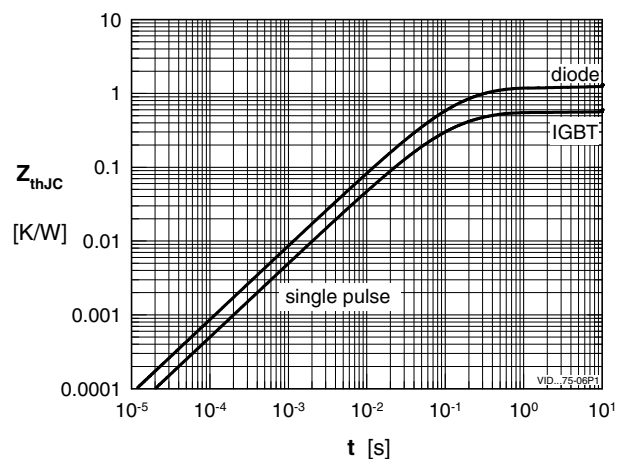

Fig. 12 Typ. transient thermal impedance RBSOA