

DS100KR401 Ultra Low Power, 4 Lane (8-channel, bi-directional) Repeater for Data-rates up to 10.3 Gbps

Check for Samples: [DS100KR401](#)

FEATURES

- **Comprehensive Product Family:**
 - **DS100KR800: 8-channel, Uni-directional Repeater**
 - **DS100KR401: 4x Lane, Bi-directional Repeater**
 - **DS100BR210: 2-channel, Uni-directional Repeater**
 - **DS100BR111: 1x Lane, Bi-directional Repeater**
- **4 Lane (8-channel, Bi-directional) Repeater for 4x 10G-KR and Other Serial Standards up to 10.3 Gbps**
- **Transparent Management of 10G-KR (802.3ap) Link Training Protocol**
- **Low 65 mW/channel (Typ) Power Consumption, with Option to Power Down Unused Channels**
- **Advanced Signal Conditioning Features**
 - **Receive Equalization up to 36 dB at 5 GHz**
 - **Transmit De-emphasis up to -12 dB**
 - **Transmit Output Voltage Control: 700 mV to 1300 mV**
- **Programmable via Pin Selection, EEPROM or SMBus Interface**
- **Single Supply Operation Selectable: 2.5V or 3.3V**
- **-40°C to +85°C Operating Temperature Range**
- **3 kV HBM ESD Rating**
- **Flow-thru Pinout in 10mm×5.5mm 54-pin Leadless WQFN Package**

DESCRIPTION

The DS100KR401 is an extremely low power, high performance repeater designed to support 4 lane (bi-directional) 10G-KR and other high speed interface serial protocols up to 10.3 Gbps. The receiver's continuous time linear equalizer (CTLE) provides a boost of up to +36 dB at 5 GHz (10.3125 Gbps) in each of its eight channels and is capable of opening an input eye that is completely closed due to inter symbol interference (ISI) induced by interconnect medium such as long backplanes or cables, hence enabling host controllers to ensure an error free end-to-end link. The transmitter provides a de-emphasis boost of up to -12 dB and output voltage amplitude control from 700 mV to 1300 mV to allow maximum flexibility in the physical placement within the interconnect channel.

When operating in 10G-KR mode, the DS100KR401 transparently allows the host controller and the end point to optimize the full link and negotiate transmit equalizer coefficients as defined in the 802.3ap standard. This seamless management of the link training protocol ensures guaranteed system level interoperability with minimum latency.

With a low power consumption of 65 mW/channel (typ) and option to turn-off unused channels, the DS100KR401 enables energy efficient system design. A single supply of 3.3v or 2.5v is required to power the device.

The programmable settings can be applied via pin settings, SMBus (I2C) protocol or an external EEPROM. When operating in the EEPROM mode, the configuration information is automatically loaded on power up. This eliminates the need for an external microprocessor or software driver.



Please be aware that an important notice concerning availability, standard warranty, and use in critical applications of Texas Instruments semiconductor products and disclaimers thereto appears at the end of this data sheet.

All trademarks are the property of their respective owners.



These devices have limited built-in ESD protection. The leads should be shorted together or the device placed in conductive foam during storage or handling to prevent electrostatic damage to the MOS gates.

TYPICAL APPLICATION

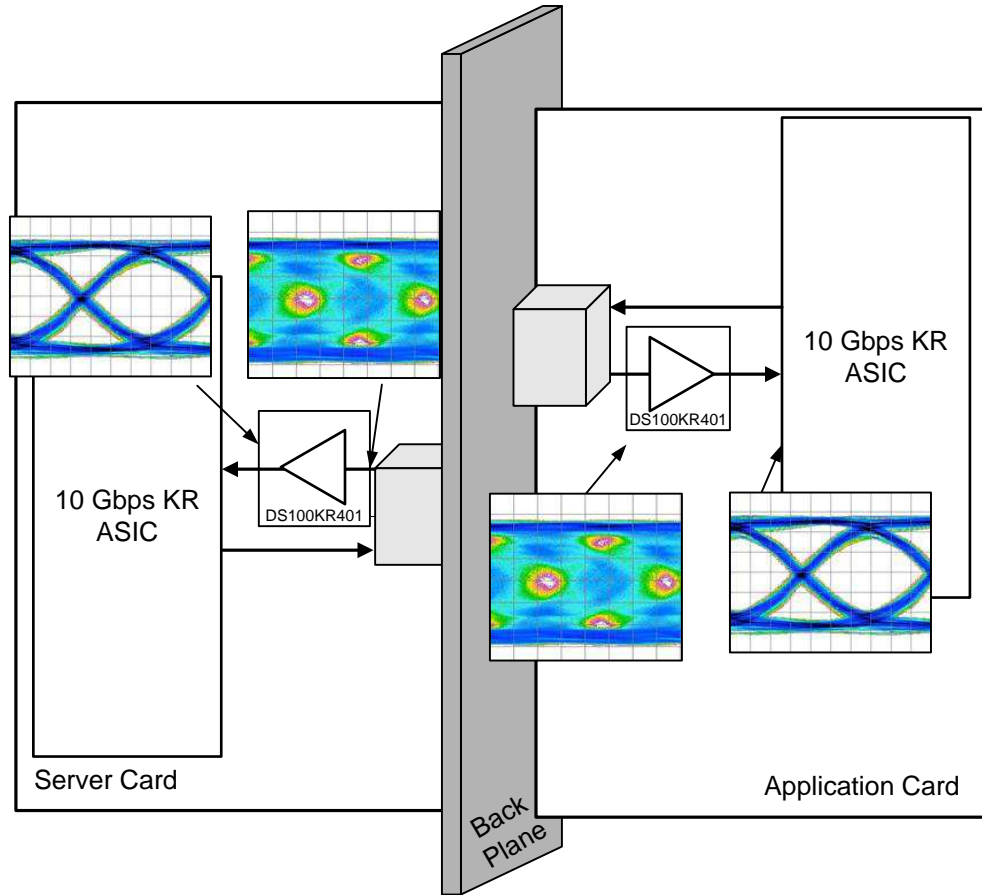

BLOCK DIAGRAM - DETAIL VIEW OF CHANNEL (1 of 8)

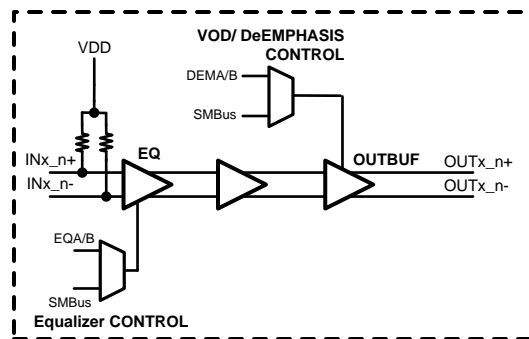

PIN DIAGRAM

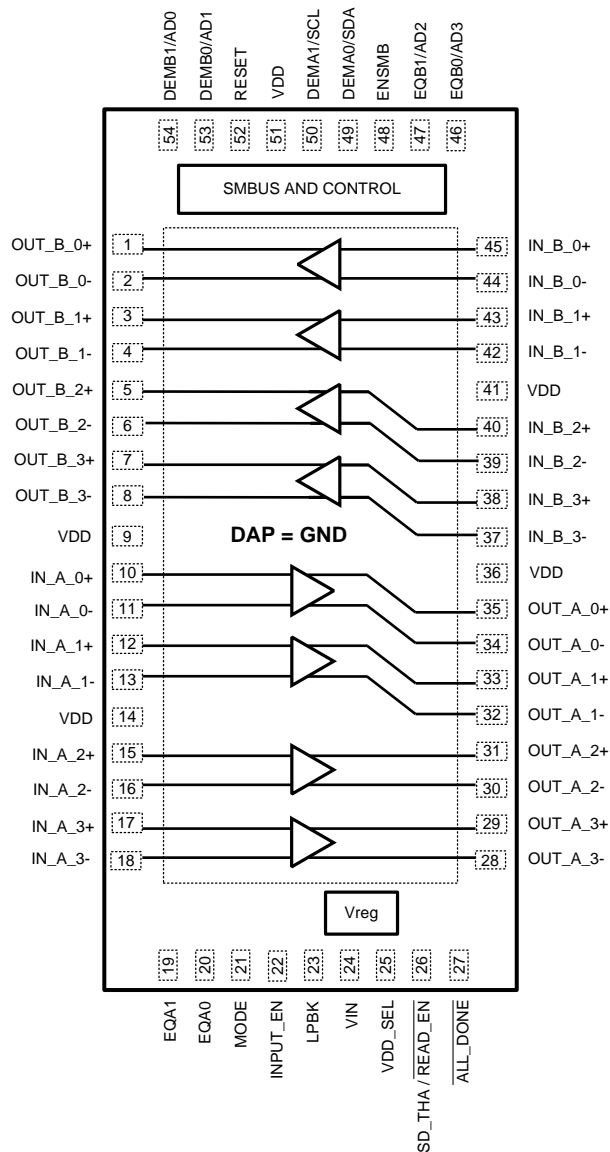

Figure 1. DS100KR401 Pin Diagram 54 lead

PIN DESCRIPTIONS⁽¹⁾

| Pin Name | Pin Number | I/O, Type | Pin Description |
|---|---|--------------------------------|--|
| Differential High Speed I/O's | | | |
| OUT_B_0+, OUT_B_0- , OUT_B_1+, OUT_B_1- , OUT_B_2+, OUT_B_2- , OUT_B_3+, OUT_B_3- | 1, 2, 3, 4, 5, 6, 7, 8 | O | Inverting and non-inverting 50Ω driver bank B outputs with de-emphasis. Compatible with AC coupled CML inputs. |
| IN_A_0+, IN_A_0- , IN_A_1+, IN_A_1- , IN_A_2+, IN_A_2- , IN_A_3+, IN_A_3- | 10, 11, 12, 13, 15, 16, 17, 18 | I | Inverting and non-inverting differential inputs to bank A equalizer. A gated on-chip 50Ω termination resistor connects INA_n+ to VDD and INA_n- to VDD when enabled. |
| IN_B_0+, IN_B_0- , IN_B_1+, IN_B_1- , IN_B_2+, IN_B_2- , IN_B_3+, IN_B_3- | 45, 44, 43, 42, 40, 39, 38, 37 | I | Inverting and non-inverting differential inputs to bank B equalizer. A gated on-chip 50Ω termination resistor connects INB_n+ to VDD and INB_n- to VDD when enabled. |
| OUT_A_0+, OUT_A_0- , OUT_A_1+, OUT_A_1- , OUT_A_2+, OUT_A_2- , OUT_A_3+, OUT_A_3- | 35, 34, 33, 32, 31, 30, 29, 28 | O | Inverting and non-inverting 50Ω driver bank A outputs with de-emphasis. Compatible with AC coupled CML inputs. |
| Control Pins — Shared (LVCMOS) | | | |
| ENSMB | 48 | I, LVCMOS | System Management Bus (SMBus) enable pin Tie 1kΩ to VDD = Register Access SMBus Slave mode FLOAT = Read External EEPROM (Master SMBUS Mode) Tie 1kΩ to GND = Pin Mode |
| ENSMB = 1 (SMBUS MODE) | | | |
| SCL | 50 | I, LVCMOS, O, OPEN Drain | ENSMB Master or Slave mode SMBUS clock input pin is enabled. Clock output when loading EEPROM configuration (master mode). |
| SDA | 49 | I, LVCMOS, O, OPEN Drain | ENSMB Master or Slave mode The SMBus bi-directional SDA pin is enabled. Data input or open drain (pull-down only) output. |
| AD0-AD3 | 54, 53, 47, 46 | I, LVCMOS | ENSMB Master or Slave mode SMBus Slave Address Inputs. In SMBus mode, these pins are the user set SMBus slave address inputs. |
| READ_EN | 26 | I, 4-LEVEL, LVCMOS | When using an External EEPROM, a transition from high to low starts the load from the external EEPROM |
| ENSMB = 0 (PIN MODE) | | | |
| EQA0, EQA1, EQB0, EQB1 | 20, 19, 46, 47 | I, 4-LEVEL, LVCMOS | EQA[1:0] and EQB[1:0] control the level of equalization on the input pins. The pins are active only when ENSMB is deasserted (low). The 8 channels are organized into two banks. Bank A is controlled with the EQA[1:0] pins and bank B is controlled with the EQB[1:0] pins. When ENSMB is high the SMBus registers provide independent control of each channel. The EQB[1:0] pins are converted to SMBUS AD2/ AD3 inputs. See Table 2 |
| DEMA0, DEMA1, DEMB0, DEMB1 | 49, 50, 53, 54 | I, 4-LEVEL, LVCMOS | DEMA[1:0] and DEMB[1:0] control the level of de-emphasis of the output driver when in Gen1/2 mode. The pins are only active when ENSMB is deasserted (low). The 8 channels are organized into two banks. Bank A is controlled with the DEMA [1:0] pins and bank B is controlled with the DEMB[1:0] pins. When ENSMB is high the SMBus registers provide independent control of each channel. The DEMA[1:0] pins are converted to SMBUS SCL/SDA and DEMB[1:0] pins are converted to AD0, AD1 inputs. See Table 3 |

- (1) Notes:
 LVCMOS inputs without the "Float" conditions must be driven to a logic low or high at all times or operation is not guaranteed.
 Input edge rate for LVCMOS/FLOAT inputs must be faster than 50 ns from 10–90%.
 For 3.3V mode operation, VIN pin = 3.3V and the "VDD" for the 4-level input is 3.3V.
 For 2.5V mode operation, VDD pin = 2.5V and the "VDD" for the 4-level input is 2.5V.

PIN DESCRIPTIONS⁽¹⁾ (continued)

| Pin Name | Pin Number | I/O, Type | Pin Description |
|---|-------------------|--------------------|---|
| MODE | 21 | I, 4-LEVEL, LVCMOS | Tie 1kΩ to VDD = 10G-KR Mode Operation Tie 1kΩ to GND = 10G Mode Operation |
| SD_TH | 26 | I, 4-LEVEL, LVCMOS | Controls the internal Signal Detect Threshold See Table 4 |
| Control Pins — Both Pin and SMBus Modes (LVCMOS) | | | |
| INPUT_EN | 22 | I, 4-LEVEL, LVCMOS | Tie 1kΩ to VDD = Normal Operation |
| LPBK | 23 | I, 4-LEVEL, LVCMOS | Controls the loopback function Tie 1kΩ to GND = INA_n to OUTB_n loopback Float = Normal Operation (loopback is disabled) Tie 1kΩ to VDD = INB_n to OUTA_n loopback |
| VDD_SEL | 25 | I, FLOAT | Controls the internal regulator Float = 2.5V mode Tie GND = 3.3V mode |
| RESET | 52 | I, LVCMOS | LOW = Device is enabled (Normal Operation) HIGH = Low Power Mode |
| Outputs | | | |
| ALL_DONE | 27 | O, LVCMOS | Valid Register Load Status Output HIGH = External EEPROM load failed LOW = External EEPROM load passed |
| Power | | | |
| VIN | 24 | Power | In 3.3V mode, feed 3.3V to VIN In 2.5V mode, leave floating. |
| VDD | 9, 14, 36, 41, 51 | Power | Power supply pins CML/analog 2.5V mode, connect to 2.5V 3.3V mode, connect 0.1 uF cap to each VDD pin |
| GND | DAP | Power | Ground pad (DAP - die attach pad). |

ABSOLUTE MAXIMUM RATINGS⁽¹⁾⁽²⁾

| | | |
|--|---|----------|
| Supply Voltage (VDD = 2.5V mode) | -0.5V to +2.75V | |
| Supply Voltage (VIN = 3.3V mode) | -0.5V to +4.0V | |
| LVCMOS Input/Output Voltage | -0.5V to +4.0V | |
| CML Input Voltage | -0.5V to (VDD+0.5) | |
| CML Input Current | -30 to +30 mA | |
| Junction Temperature | 125°C | |
| Storage Temperature | -40°C to +125°C | |
| Lead Temperature Range Soldering (4 sec.) | +260°C | |
| Derate NJY0054A Package | 52.6mW/°C above +25°C | |
| ESD Rating | HBM, STD - JESD22-A114F | 5 kV |
| | MM, STD - JESD22-A115-A | 150 V |
| | CDM, STD - JESD22-C101-D | 1000 V |
| Thermal Resistance | θ_{JC} | 11.5°C/W |
| | θ_{JA} , No Airflow, 4 layer JEDEC | 19.1°C/W |
| For soldering specifications: see product folder at www.ti.com , and SNOA549 | | |

- (1) "Absolute Maximum Ratings" indicate limits beyond which damage to the device may occur, including inoperability and degradation of device reliability and/or performance. Functional operation of the device and/or non-degradation at the Absolute Maximum Ratings or other conditions beyond those indicated in the Recommended Operating Conditions is not implied. The Recommended Operating Conditions indicate conditions at which the device is functional and the device should not be operated beyond such conditions. Absolute Maximum Numbers are specified for a junction temperature range of -40°C to +125°C. Models are validated to Maximum Operating Voltages only.
- (2) If Military/Aerospace specified devices are required, please contact the Texas Instruments Sales Office/ Distributors for availability and specifications.

RECOMMENDED OPERATING CONDITIONS

| | Min | Typ | Max | Units |
|--|-------|-----|-------|-------|
| Supply Voltage (2.5V mode) | 2.375 | 2.5 | 2.625 | V |
| Supply Voltage (3.3V mode) | 3.0 | 3.3 | 3.6 | V |
| Ambient Temperature | -40 | 25 | +85 | °C |
| SMBus (SDA, SCL) | | | 3.6 | V |
| Supply Noise up to 50 MHz ⁽¹⁾ | | | 100 | mVp-p |

(1) Allowed supply noise (mVp-p sine wave) under typical conditions.

ELECTRICAL CHARACTERISTICS⁽¹⁾

| Symbol | Parameter | Conditions | Min | Typ ⁽²⁾ | Max | Units |
|---|--|--|------|--------------------|------|--------|
| Power | | | | | | |
| PD | Power Dissipation | VDD = 2.5 V supply, EQ Enabled, VOD = 1.0 Vp-p, INPUT_EN = 1, RESET = 0 | | 500 | 700 | mW |
| | | VIN = 3.3 V supply, EQ Enabled, VOD = 1.0 Vp-p, INPUT_EN = 1, RESET = 0 | | 660 | 900 | mW |
| LVC MOS / LVTTTL DC Specifications | | | | | | |
| V _{ih} | High Level Input Voltage | 3.3V Mode Operation (VIN = 3.3V) | 2.0 | | 3.6 | V |
| V _{il} | Low Level Input Voltage | | 0 | | 0.8 | V |
| V _{oh} | High Level Output Voltage (ALL_DONE pin) | I _{oh} = -4mA | 2.0 | | | V |
| V _{ol} | Low Level Output Voltage (ALL_DONE pin) | I _{ol} = 4mA | | | 0.4 | V |
| I _{ih} | Input High Current (RESET pin) | VIN = 3.6 V, LVC MOS = 3.6 V | -15 | | +15 | µA |
| | Input High Current with internal resistors (4-level input pin) | | +20 | | +150 | µA |
| I _{il} | Input Low Current (RESET pin) | VIN = 3.6 V, LVC MOS = 0 V | -15 | | +15 | µA |
| | Input Low Current with internal resistors (4-level input pin) | | -160 | | -40 | µA |
| CML Receiver Inputs (IN_{n+}, IN_{n-}) | | | | | | |
| RL _{rx-diff} | RX package pins plus Si differential return loss | 0.05 GHz - 7.5 GHz | | -15 | | dB |
| | | 7.5 GHz - 15 GHz | | -5 | | dB |
| RL _{rx-cm} | Common mode RX return loss | 0.05 GHz - 5 GHz | | -10 | | dB |
| Z _{rx-dc} | RX DC common mode impedance | Tested at VDD = 0 | 40 | 50 | 60 | Ω |
| Z _{rx-diff-dc} | RX DC differential mode impedance | Tested at VDD = 0 | 80 | 100 | 120 | Ω |
| V _{rx-diff-dc} | Differential RX peak to peak voltage | Tested at pins | 0.6 | | 1.2 | V |
| V _{rx-signal-det-diff-pp} | Signal detect assert level for active data signal | SD_TH = F (float), 0101 pattern at 10.3 Gbps | | 180 | | mVp-p |
| V _{rx-idle-det-diff-pp} | Signal detect de-assert level for electrical idle | SD_TH = F (float), 0101 pattern at 10.3 Gbps | | 110 | | mVp-p |
| High Speed Outputs | | | | | | |
| V _{tx-diff-pp} | Output Voltage Differential Swing | Differential measurement with Out _{n+} and OUT _{n-} , terminated by 50Ω to GND, AC-Coupled, VID = 1.0 Vp-p, DEM0 = 1, DEM1 = 0 | 0.8 | 1.0 | 1.2 | Vp-p |
| V _{tx-de-ratio_3.5} | TX de-emphasis ratio | VOD = 1.0 Vp-p, DEM0 = 0, DEM1 = R | | -3.5 | | dB |
| V _{tx-de-ratio_6} | TX de-emphasis ratio | VOD = 1.0 Vp-p, DEM0 = R, DEM1 = R | | -6 | | dB |
| T _{TX-HF-DJ-DD} | TX Dj > 1.5 MHz | | | | 0.15 | UI |
| T _{TX-HF-DJ-DD} | TX RMS jitter < 1.5 MHz | | | | 3.0 | ps RMS |

- (1) The Electrical Characteristics tables list specifications under the listed Recommended Operating Conditions except as otherwise modified or specified by the Electrical Characteristics Conditions and/or Notes. Typical specifications are estimations only and are **NOT** guaranteed.
- (2) Typical values represent most likely parametric norms at VDD = 2.5V, TA = 25°C., and at the Recommended Operation Conditions at the time of product characterization and are **NOT** guaranteed.

ELECTRICAL CHARACTERISTICS⁽¹⁾ (continued)

| Symbol | Parameter | Conditions | Min | Typ ⁽²⁾ | Max | Units |
|---------------------------|--|---|-----|--------------------|-----|-------|
| T _{TX-RISE-FALL} | Transmitter rise/fall time | 20% to 80% of differential output voltage | 35 | 45 | | ps |
| T _{RF-MISMATCH} | Transmitter rise/fall mismatch | 20% to 80% of differential output voltage | | 0.01 | 0.1 | UI |
| RL _{TX-DIFF} | Differential return loss | 0.05 GHz - 7.5 GHz | | -15 | | dB |
| | | 7.5 GHz - 15 GHz | | -5 | | dB |
| RL _{TX-CM} | Common mode return loss | 0.05 GHz - 5 GHz | | -10 | | dB |
| Z _{TX-DIFF-DC} | DC differential TX impedance | | | 100 | | Ω |
| V _{TX-CM-AC-PP} | TX AC common mode voltage | VOD = 1.0 Vp-p, DEM0 = 1, DEM1 = 0 | | | 100 | mVpp |
| I _{TX-SHORT} | Transmitter short circuit current limit | Total current the transmitter can supply when shorted to VDD or GND | | 20 | | mA |
| T _{PDEQ} | Differential propagation delay | EQ = 00, ⁽³⁾ | | 200 | | ps |
| T _{LSK} | Lane to lane skew | T = 25C, VDD = 2.5V | | 25 | | ps |
| T _{PPSK} | Part to part propagation delay skew | T = 25C, VDD = 2.5V | | 40 | | ps |
| Equalization | | | | | | |
| DJE1 | Residual deterministic jitter at 10.3 Gbps | 35" 4 mil FR4, VID = 0.8 Vp-p, PRBS15, EQ = 1F'h, DEM = 0 dB | | 0.3 | | UI |
| DJE2 | Residual deterministic jitter at 10.3 Gbps | 10 meters 30 awg cable, VID = 0.8 Vp-p, PRBS15, EQ = 2F'h, DEM = 0 dB | | 0.3 | | UI |
| De-emphasis | | | | | | |
| DJD1 | Residual deterministic jitter at 10.3 Gbps | 20" 4mils FR4, VID = 0.8 Vp-p, PRBS15, EQ = 00, VOD = 1.0 Vp-p, DEM = -9 dB | | 0.1 | | UI |

(3) Propagation Delay measurements will change slightly based on the level of EQ selected. EQ = 00 will result in the shortest propagation delays.

ELECTRICAL CHARACTERISTICS — SERIAL MANAGEMENT BUS INTERFACE

Over recommended operating supply and temperature ranges unless other specified.

| Symbol | Parameter | Conditions | Min | Typ | Max | Units |
|---|--|---|-------|------|------|-------|
| SERIAL BUS INTERFACE DC SPECIFICATIONS | | | | | | |
| V _{IL} | Data, Clock Input Low Voltage | | | | 0.8 | V |
| V _{IH} | Data, Clock Input High Voltage | | 2.1 | | 3.6 | V |
| I _{PULLUP} | Current Through Pull-Up Resistor or Current Source | High Power Specification | 4 | | | mA |
| V _{DD} | Nominal Bus Voltage | | 2.375 | | 3.6 | V |
| I _{LEAK-Bus} | Input Leakage Per Bus Segment | See ⁽¹⁾ | -200 | | +200 | μA |
| I _{LEAK-Pin} | Input Leakage Per Device Pin | | | -15 | | μA |
| C _I | Capacitance for SDA and SCL | See ⁽¹⁾ ⁽²⁾ | | | 10 | pF |
| R _{TERM} | External Termination Resistance pull to V _{DD} = 2.5V ± 5% OR 3.3V ± 10% | Pullup V _{DD} = 3.3V, See ⁽¹⁾ ⁽²⁾ ⁽³⁾ | | 2000 | | Ω |
| | | Pullup V _{DD} = 2.5V, See ⁽¹⁾ ⁽²⁾ ⁽³⁾ | | 1000 | | Ω |
| SERIAL BUS INTERFACE TIMING SPECIFICATIONS | | | | | | |
| FSMB | Bus Operating Frequency | ENSMB = VDD (Slave Mode) | | | 400 | kHz |
| | | ENSMB = FLOAT (Master Mode) | 280 | 400 | 520 | kHz |
| TBUF | Bus Free Time Between Stop and Start Condition | | 1.3 | | | μs |
| THD:STA | Hold time after (Repeated) Start Condition. After this period, the first clock is generated. | At I _{PULLUP} , Max | 0.6 | | | μs |
| TSU:STA | Repeated Start Condition Setup Time | | 0.6 | | | μs |

(1) Recommended value.

(2) Recommended maximum capacitance load per bus segment is 400pF.

(3) Maximum termination voltage should be identical to the device supply voltage.

ELECTRICAL CHARACTERISTICS — SERIAL MANAGEMENT BUS INTERFACE (continued)

Over recommended operating supply and temperature ranges unless other specified.

| Symbol | Parameter | Conditions | Min | Typ | Max | Units |
|-------------------|---|-------------|-----|-----|-----|---------|
| TSU:STO | Stop Condition Setup Time | | 0.6 | | | μ s |
| THD:DAT | Data Hold Time | | 0 | | | ns |
| TSU:DAT | Data Setup Time | | 100 | | | ns |
| T _{LOW} | Clock Low Period | | 1.3 | | | μ s |
| T _{HIGH} | Clock High Period | See (4) | 0.6 | | 50 | μ s |
| t _F | Clock/Data Fall Time | See (4) | | | 300 | ns |
| t _R | Clock/Data Rise Time | See (4) | | | 300 | ns |
| t _{POR} | Time in which a device must be operational after power-on reset | See (4) (5) | | | 500 | ms |

- (4) Compliant to SMBus 2.0 physical layer specification. See System Management Bus (SMBus) Specification Version 2.0, section 3.1.1 SMBus common AC specifications for details.
- (5) Specified by Design. Parameter not tested in production.

TIMING DIAGRAMS

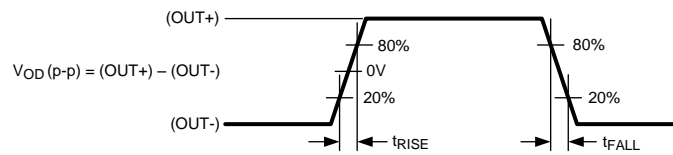

Figure 2. CML Output and Rise and FALL Transition Time

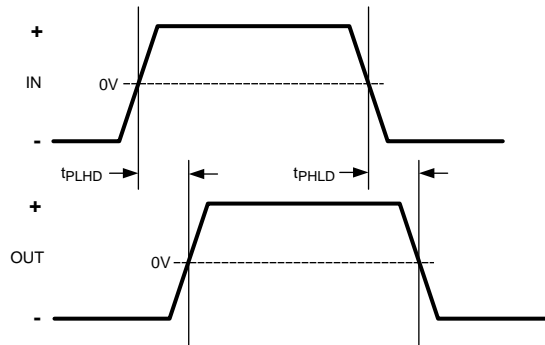

Figure 3. Propagation Delay Timing Diagram

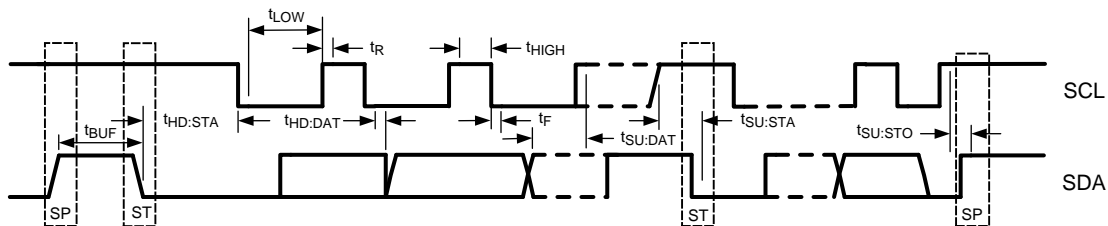

Figure 4. SMBus Timing Parameters

FUNCTIONAL DESCRIPTIONS

The DS100KR401 is a low power media compensation 4 lane repeater optimized for 10G–KR. The DS100KR401 compensates for lossy FR-4 printed circuit board backplanes and balanced cables. The DS100KR401 operates in 3 modes: Pin Control Mode (ENSMB = 0), SMBus Slave Mode (ENSMB = 1) and SMBus Master Mode (ENSMB = float) to load register informations from external EEPROM; please refer to SMBUS Master Mode for additional information.

Pin Control Mode:

When in pin mode (ENSMB = 0), the repeater is configurable with external pins. Equalization and de-emphasis can be selected via pin for each side independently. When de-emphasis is asserted VOD is automatically adjusted per the De-Emphasis table below. The receiver electrical idle detect threshold is also adjustable via the SD_TH pin.

SMBUS Mode:

When in SMBus mode (ENSMB = 1), the VOD (output amplitude), equalization, de-emphasis, and termination disable features are all programmable on a individual lane basis, instead of grouped by A or B as in the pin mode case. Upon assertion of ENSMB the MODE, EQx and DEMx functions revert to register control immediately. The EQx and DEMx pins are converted to AD0-AD3 SMBus address inputs. The other external control pins remain active unless their respective registers are written to and the appropriate override bit is set, in which case they are ignored until ENSMB is driven low (pin mode). On power-up and when ENSMB is driven low all registers are reset to their default state. If RESET is asserted while ENSMB is high, the registers retain their current state.

Equalization settings accessible via the pin controls were chosen to meet the needs of most applications. If additional fine tuning or adjustment is needed, additional equalization settings can be accessed via the SMBus registers. Each input has a total of 256 possible equalization settings. The tables show the 16 setting when the device is in pin mode. When using SMBus mode, the equalization, VOD and de-Emphasis levels are set by registers.

The input control pins have been enhanced to have 4 different levels and provide a wider range of control settings when ENSMB=0.

Table 1. 4–Level Control Pin Settings⁽¹⁾

| Pin Setting | Description | Voltage at Pin |
|-------------|------------------------|----------------|
| 0 | Tie 1kΩ to GND | 0.03 x VDD |
| R | Tie 20kΩ to GND | 1/3 x VDD |
| Float | Float (leave pin open) | 2/3 x VDD |
| 1 | Tie 1kΩ to VDD | 0.98 x VDD |

(1) The above required resistor value is for a single device. When there are multiple devices connected to the pull-up / pull-down resistor, the value must scale with the number of devices. If 4 devices are connected to a single pull-up or pull-down, the 1kΩ resistor value should be 250Ω. For the 20kΩ to GND, this should also scale to 5kΩ.

3.3V or 2.5V Supply Mode Operation

The DS100KR401 has an optional internal voltage regulator to provide the 2.5V supply to the device. In 3.3V mode, the VIN pin = 3.3V is used to supply power to the device and the VDD pins should be left open. The internal regulator will provide the 2.5V to the VDD pins of the device and a 0.1 μF cap is needed at each of 5 VDD pins for power supply de-coupling (total capacitance should be ≤0.5 μF). The VDD_SEL pin must be tied to GND to enable the internal regulator. In 2.5V mode, the VIN pin should be left open and 2.5V supply must be applied to the VDD pins. The VDD_SEL pin must be left open (no connect) to disable the internal regulator.

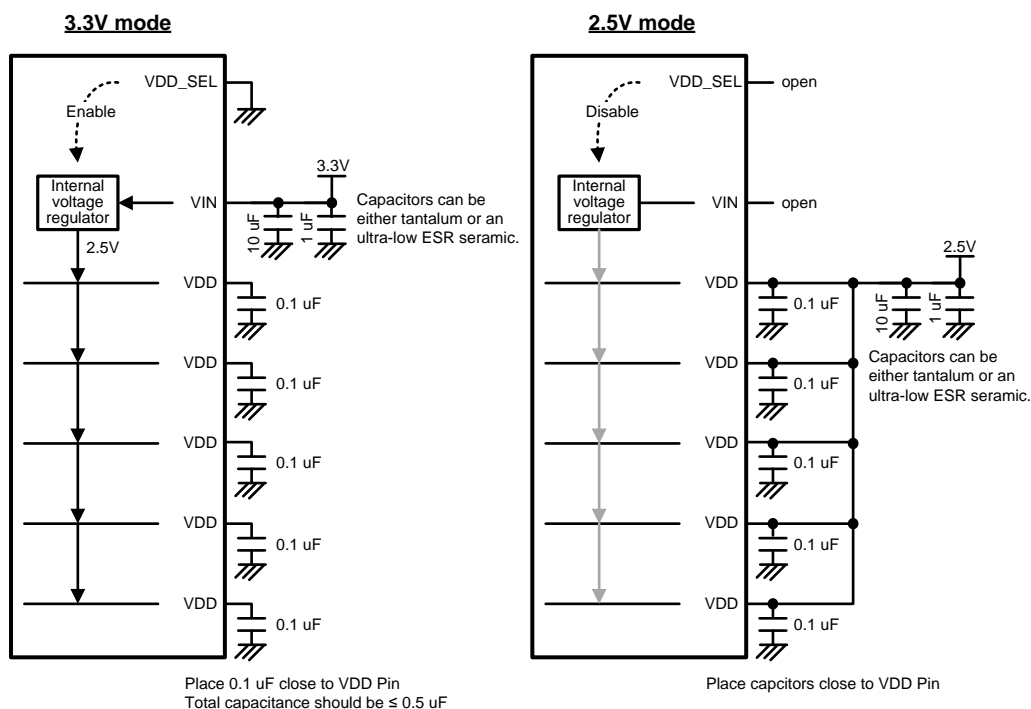

Figure 5. 3.3V or 2.5V Supply Connection Diagram

Table 2. Equalizer Settings

| Level | EQA1 EQB1 | EQA0 EQB0 | EQ – 8 bits [7:0] | dB at 1.0 GHz | dB at 3.0 GHz | dB at 5.0 GHz | Suggested Use |
|-------|--------------|--------------|-------------------|------------------|------------------|------------------|-------------------------------|
| 1 | 0 | 0 | 0000 0000 = 0x00 | 1.7 | 4.2 | 5.3 | FR4 < 5 inch trace |
| 2 | 0 | R | 0000 0001 = 0x01 | 2.8 | 6.6 | 8.7 | FR4 5 inch 5–mil trace |
| 3 | 0 | Float | 0000 0010 = 0x02 | 4.1 | 8.6 | 10.6 | FR4 5 inch 4–mil trace |
| 4 | 0 | 1 | 0000 0011 = 0x03 | 5.1 | 9.8 | 11.7 | FR4 10 inch 5–mil trace |
| 5 | R | 0 | 0000 0111 = 0x07 | 6.2 | 12.4 | 15.6 | FR4 10 inch 4–mil trace |
| 6 | R | R | 0001 0101 = 0x15 | 5.1 | 12.0 | 16.6 | FR4 15 inch 4–mil trace |
| 7 | R | Float | 0000 1011 = 0x0B | 7.7 | 15.0 | 18.3 | FR4 20 inch 4–mil trace |
| 8 | R | 1 | 0000 1111 = 0x0F | 8.8 | 16.5 | 19.7 | FR4 25 to 30 inch 4–mil trace |
| 9 | Float | 0 | 0101 0101 = 0x55 | 6.3 | 14.8 | 20.3 | FR4 30 inch 4–mil trace |
| 10 | Float | R | 0001 1111 = 0x1F | 9.9 | 19.2 | 23.6 | FR4 35 inch 4–mil trace |
| 11 | Float | Float | 0010 1111 = 0x2F | 11.3 | 21.7 | 25.8 | 10m, 30awg cable |
| 12 | Float | 1 | 0011 1111 = 0x3F | 12.4 | 23.2 | 27.0 | 10m – 12m cable |
| 13 | 1 | 0 | 1010 1010 = 0xAA | 11.9 | 24.1 | 29.1 | |
| 14 | 1 | R | 0111 1111 = 0x7F | 13.6 | 26.0 | 30.7 | |
| 15 | 1 | Float | 1011 1111 = 0xBF | 15.1 | 28.3 | 32.7 | |
| 16 | 1 | 1 | 1111 1111 = 0xFF | 16.1 | 29.7 | 33.8 | |

Table 3. De-emphasis and Output Voltage Settings

| Level | DEMA1 DEMB1 | DEMA0 DEMB0 | VOD Vp-p | DEM dB | Inner Amplitude Vp-p | Suggested Use |
|-------|----------------|----------------|----------|--------|-------------------------|-------------------------|
| 1 | 0 | 0 | 0.8 | 0 | 0.8 | FR4 <5 inch 4-mil trace |
| 2 | 0 | R | 0.9 | 0 | 0.9 | FR4 <5 inch 4-mil trace |
| 3 | 0 | Float | 0.9 | - 3.5 | 0.6 | FR4 10 inch 4-mil trace |
| 4 | 0 | 1 | 1.0 | 0 | 1.0 | FR4 <5 inch 4-mil trace |
| 5 | R | 0 | 1.0 | - 3.5 | 0.7 | FR4 10 inch 4-mil trace |
| 6 | R | R | 1.0 | - 6 | 0.5 | FR4 15 inch 4-mil trace |
| 7 | R | Float | 1.1 | 0 | 1.1 | FR4 <5 inch 4-mil trace |
| 8 | R | 1 | 1.1 | - 3.5 | 0.7 | FR4 10 inch 4-mil trace |
| 9 | Float | 0 | 1.1 | - 6 | 0.6 | FR4 15 inch 4-mil trace |
| 10 | Float | R | 1.2 | 0 | 1.2 | FR4 <5 inch 4-mil trace |
| 11 | Float | Float | 1.2 | - 3.5 | 0.8 | FR4 10 inch 4-mil trace |
| 12 | Float | 1 | 1.2 | - 6 | 0.6 | FR4 15 inch 4-mil trace |
| 13 | 1 | 0 | 1.3 | 0 | 1.3 | FR4 <5 inch 4-mil trace |
| 14 | 1 | R | 1.3 | - 3.5 | 0.9 | FR4 10 inch 4-mil trace |
| 15 | 1 | Float | 1.3 | - 6 | 0.7 | FR4 15 inch 4-mil trace |
| 16 | 1 | 1 | 1.3 | - 9 | 0.5 | FR4 20 inch 4-mil trace |

Table 4. Signal Detect Threshold Level⁽¹⁾

| SD_TH | SMBus REG bit [3:2] and [1:0] | Assert Level (typ) | De-assert Level (typ) |
|-------------|-------------------------------|--------------------|-----------------------|
| 0 | 10 | 210 mVp-p | 150 mVp-p |
| R | 01 | 160 mVp-p | 100 mVp-p |
| F (default) | 00 | 180 mVp-p | 110 mVp-p |
| 1 | 11 | 190 mVp-p | 130 mVp-p |

(1) VDD = 2.5V, 25°C and 0101 pattern at 10.3 Gbps

SMBUS Master Mode

The DS100KR401 devices support reading directly from an external EEPROM device by implementing SMBus Master mode. When using the SMBus master mode, the DS100KR401 will read directly from specific location in the external EEPROM. When designing a system for using the external EEPROM, the user needs to follow these specific guidelines.

- Set ENSMB = Float — enable the SMBUS master mode.
- The external EEPROM device address byte must be 0xA0'h and capable of 400 kHz operation at 2.5V and 3.3V supply.
- Set the AD[3:0] inputs for SMBus address byte. When the AD[3:0] = 0000'b, the device address byte is B0'h.

When tying multiple DS100KR401 devices to the SDA and SCL bus, use these guidelines to configure the devices.

- Use SMBus AD[3:0] address bits so that each device can loaded it's configuration from the EEPROM. Example below is for 4 device.
 - U1: AD[3:0] = 0000 = 0xB0'h,
 - U2: AD[3:0] = 0001 = 0xB2'h,
 - U3: AD[3:0] = 0010 = 0xB4'h,
 - U4: AD[3:0] = 0011 = 0xB6'h
- Use a pull-up resistor on SDA and SCL; value = 2k ohms
- Daisy-chain READEN# (pin 26) and ALL_DONE# (pin 27) from one device to the next device in the sequence so that they do not compete for the EEPROM at the same time.
 - 1. Tie READEN# of the 1st device in the chain (U1) to GND
 - 2. Tie ALL_DONE# of U1 to READEN# of U2

Table 5. EEPROM Register Map - Single Device with Default Value

| EEPROM Address Byte | | Bit 7 | Bit 6 | Bit 5 | Bit 4 | Bit 3 | Bit 2 | Bit 1 | Bit 0 |
|---------------------|----|--------------------------|--------------------------|--------------------------|--------------------------|--------------------------|--------------------------|--------------------------|--------------------------|
| Description | 0 | CRC EN | Address Map Present | EEPROM > 256 Bytes | RES | DEVICE COUNT[3] | DEVICE COUNT[2] | DEVICE COUNT[1] | DEVICE COUNT[0] |
| Value | | 0 | 0 | 0 | 0 | 0 | 0 | 0 | 0 |
| Description | 1 | RES | RES | RES | RES | RES | RES | RES | RES |
| Value | | 0 | 0 | 0 | 0 | 0 | 0 | 0 | 0 |
| Description | 2 | Max EEPROM Burst size[7] | Max EEPROM Burst size[6] | Max EEPROM Burst size[5] | Max EEPROM Burst size[4] | Max EEPROM Burst size[3] | Max EEPROM Burst size[2] | Max EEPROM Burst size[1] | Max EEPROM Burst size[0] |
| Value | | 0 | 0 | 0 | 0 | 0 | 0 | 0 | 0 |
| Description | 3 | PWDN_ch7 | PWDN_ch6 | PWDN_ch5 | PWDN_ch4 | PWDN_ch3 | PWDN_ch2 | PWDN_ch1 | PWDN_ch0 |
| Value | | 0 | 0 | 0 | 0 | 0 | 0 | 0 | 0 |
| Description | 4 | RES_1 | RES_0 | PWDN_INPUTS | PWDN_OSC | Ovrd_RESET | RES | RES | RES |
| Value | | 0 | 0 | 0 | 0 | 0 | 0 | 0 | 0 |
| Description | 5 | RES | RES | RES | RES | RES | RES_btb_en | Ovrd_RES | Ovrd_RES |
| Value | | 0 | 0 | 0 | 0 | 0 | 1 | 0 | 0 |
| Description | 6 | Ovrd_RES | Ovrd_RES | Ovrd_RES | Ovrd_RES | Ovrd_RES | rx_delay_sel_2 | rx_delay_sel_1 | rx_delay_sel_0 |
| Value | | 0 | 0 | 0 | 0 | 0 | 1 | 1 | 1 |
| Description | 7 | RD_delay_sel_3 | RD_delay_sel_2 | RD_delay_sel_1 | RD_delay_sel_0 | ch0_Idle_auto | ch0_Idle_sel | ch0_RES_1 | ch0_RES_0 |
| Value | | 0 | 0 | 0 | 0 | 0 | 0 | 0 | 0 |
| Description | 8 | ch0_BST_7 | ch0_BST_6 | ch0_BST_5 | ch0_BST_4 | ch0_BST_3 | ch0_BST_2 | ch0_BST_1 | ch0_BST_0 |
| Value | | 0 | 0 | 1 | 0 | 1 | 1 | 1 | 1 |
| Description | 9 | ch0_Sel_scp | ch0_Sel_mode | ch0_RES_2 | ch0_RES_1 | ch0_RES_0 | ch0_VOD_2 | ch0_VOD_1 | ch0_VOD_0 |
| Value | | 1 | 0 | 1 | 0 | 1 | 1 | 0 | 1 |
| Description | 10 | ch0_DEM_2 | ch0_DEM_1 | ch0_DEM_0 | ch0_Slow | ch0_idle_tha_1 | ch0_idle_tha_0 | ch0_idle_thd_1 | ch0_idle_thd_0 |
| Value | | 0 | 1 | 0 | 0 | 0 | 0 | 0 | 0 |
| Description | 11 | ch1_Idle_auto | ch1_Idle_sel | ch1_RES_1 | ch1_RES_0 | ch1_BST_7 | ch1_BST_6 | ch1_BST_5 | ch1_BST_4 |
| Value | | 0 | 0 | 0 | 0 | 0 | 0 | 1 | 0 |
| Description | 12 | ch1_BST_3 | ch1_BST_2 | ch1_BST_1 | ch1_BST_0 | ch1_Sel_scp | ch1_Sel_mode | ch1_RES_2 | ch1_RES_1 |
| Value | | 1 | 1 | 1 | 1 | 1 | 0 | 1 | 0 |
| Description | 13 | ch1_RES_0 | ch1_VOD_2 | ch1_VOD_1 | ch1_VOD_0 | ch1_DEM_2 | ch1_DEM_1 | ch1_DEM_0 | ch1_Slow |
| Value | | 1 | 1 | 0 | 1 | 0 | 1 | 0 | 0 |
| Description | 14 | ch1_idle_tha_1 | ch1_idle_tha_0 | ch1_idle_thd_1 | ch1_idle_thd_0 | ch2_Idle_auto | ch2_Idle_sel | ch2_RES_1 | ch2_RES_0 |
| Value | | 0 | 0 | 0 | 0 | 0 | 0 | 0 | 0 |
| Description | 15 | ch2_BST_7 | ch2_BST_6 | ch2_BST_5 | ch2_BST_4 | ch2_BST_3 | ch2_BST_2 | ch2_BST_1 | ch2_BST_0 |
| Value | | 0 | 0 | 1 | 0 | 1 | 1 | 1 | 1 |

Table 5. EEPROM Register Map - Single Device with Default Value (continued)

| EEPROM Address Byte | | Bit 7 | Bit 6 | Bit 5 | Bit 4 | Bit 3 | Bit 2 | Bit 1 | Bit 0 |
|---------------------|----|----------------|----------------|----------------|----------------|----------------|-------------------|-------------------|----------------|
| Description | 16 | ch2_Sel_scp | ch2_Sel_mode | ch2_RES_2 | ch2_RES_1 | ch2_RES_0 | ch2_VOD_2 | ch2_VOD_1 | ch2_VOD_0 |
| Value | | 1 | 0 | 1 | 0 | 1 | 1 | 0 | 1 |
| Description | 17 | ch2_DEM_2 | ch2_DEM_1 | ch2_DEM_0 | ch2_Slow | ch2_idle_tha_1 | ch2_idle_tha_0 | ch2_idle_thd_1 | ch2_idle_thd_0 |
| Value | | 0 | 1 | 0 | 0 | 0 | 0 | 0 | 0 |
| Description | 18 | ch3_Idle_auto | ch3_Idle_sel | ch3_RES_1 | ch3_RES_0 | ch3_BST_7 | ch3_BST_6 | ch3_BST_5 | ch3_BST_4 |
| Value | | 0 | 0 | 0 | 0 | 0 | 0 | 1 | 0 |
| Description | 19 | ch3_BST_3 | ch3_BST_2 | ch3_BST_1 | ch3_BST_0 | ch3_Sel_scp | ch3_Sel_mode | ch3_RES_2 | ch3_RES_1 |
| Value | | 1 | 1 | 1 | 1 | 1 | 0 | 1 | 0 |
| Description | 20 | ch3_RES_0 | ch3_VOD_2 | ch3_VOD_1 | ch3_VOD_0 | ch3_DEM_2 | ch3_DEM_1 | ch3_DEM_0 | ch3_Slow |
| Value | | 1 | 1 | 0 | 1 | 0 | 1 | 0 | 0 |
| Description | 21 | ch3_idle_tha_1 | ch3_idle_tha_0 | ch3_idle_thd_1 | ch3_idle_thd_0 | ovrd_fast_idle | en_high_idle_th_n | en_high_idle_th_s | en_fast_idle_n |
| Value | | 0 | 0 | 0 | 0 | 0 | 0 | 0 | 1 |
| Description | 22 | en_fast_idle_s | eqsd_mgain_n | eqsd_mgain_s | ch4_Idle_auto | ch4_Idle_sel | ch4_RXDET_1 | ch4_RXDET_0 | ch4_BST_7 |
| Value | | 1 | 0 | 0 | 0 | 0 | 0 | 0 | 0 |
| Description | 23 | ch4_BST_6 | ch4_BST_5 | ch4_BST_4 | ch4_BST_3 | ch4_BST_2 | ch4_BST_1 | ch4_BST_0 | ch4_Sel_scp |
| Value | | 0 | 1 | 0 | 1 | 1 | 1 | 1 | 1 |
| Description | 24 | ch4_Sel_mode | ch4_RES_2 | ch4_RES_1 | ch4_RES_0 | ch4_VOD_2 | ch4_VOD_1 | ch4_VOD_0 | ch4_DEM_2 |
| Value | | 0 | 1 | 0 | 1 | 1 | 0 | 1 | 0 |
| Description | 25 | ch4_DEM_1 | ch4_DEM_0 | ch4_Slow | ch4_idle_tha_1 | ch4_idle_tha_0 | ch4_idle_thd_1 | ch4_idle_thd_0 | ch5_Idle_auto |
| Value | | 1 | 0 | 0 | 0 | 0 | 0 | 0 | 0 |
| Description | 26 | ch5_Idle_sel | ch5_RES_1 | ch5_RES_0 | ch5_BST_7 | ch5_BST_6 | ch5_BST_5 | ch5_BST_4 | ch5_BST_3 |
| Value | | 0 | 0 | 0 | 0 | 0 | 1 | 0 | 1 |
| Description | 27 | ch5_BST_2 | ch5_BST_1 | ch5_BST_0 | ch5_Sel_scp | ch5_Sel_mode | ch5_RES_2 | ch5_RES_1 | ch5_RES_0 |
| Value | | 1 | 1 | 1 | 1 | 0 | 1 | 0 | 1 |
| Description | 28 | ch5_VOD_2 | ch5_VOD_1 | ch5_VOD_0 | ch5_DEM_2 | ch5_DEM_1 | ch5_DEM_0 | ch5_Slow | ch5_idle_tha_1 |
| Value | | 1 | 0 | 1 | 0 | 1 | 0 | 0 | 0 |
| Description | 29 | ch5_idle_tha_0 | ch5_idle_thd_1 | ch5_idle_thd_0 | ch6_Idle_auto | ch6_Idle_sel | ch6_RES_1 | ch6_RES_0 | ch6_BST_7 |
| Value | | 0 | 0 | 0 | 0 | 0 | 0 | 0 | 0 |
| Description | 30 | ch6_BST_6 | ch6_BST_5 | ch6_BST_4 | ch6_BST_3 | ch6_BST_2 | ch6_BST_1 | ch6_BST_0 | ch6_Sel_scp |
| Value | | 0 | 1 | 0 | 1 | 1 | 1 | 1 | 1 |
| Description | 31 | ch6_Sel_mode | ch6_RES_2 | ch6_RES_1 | ch6_RES_0 | ch6_VOD_2 | ch6_VOD_1 | ch6_VOD_0 | ch6_DEM_2 |
| Value | | 0 | 1 | 0 | 1 | 1 | 0 | 1 | 0 |

Table 5. EEPROM Register Map - Single Device with Default Value (continued)

| EEPROM Address Byte | | Bit 7 | Bit 6 | Bit 5 | Bit 4 | Bit 3 | Bit 2 | Bit 1 | Bit 0 |
|---------------------|----|----------------|----------------|----------------|----------------|----------------|----------------|----------------|----------------|
| Description | 32 | ch6_DEM_1 | ch6_DEM_0 | ch6_Slow | ch6_idle_tha_1 | ch6_idle_tha_0 | ch6_idle_thd_1 | ch6_idle_thd_0 | ch7_Idle_auto |
| Value | | 1 | 0 | 0 | 0 | 0 | 0 | 0 | 0 |
| Description | 33 | ch7_Idle_sel | ch7_RES_1 | ch7_RES_0 | ch7_BST_7 | ch7_BST_6 | ch7_BST_5 | ch7_BST_4 | ch7_BST_3 |
| Value | | 0 | 0 | 0 | 0 | 0 | 1 | 0 | 1 |
| Description | 34 | ch7_BST_2 | ch7_BST_1 | ch7_BST_0 | ch7_Sel_scp | ch7_Sel_mode | ch7_RES_2 | ch7_RES_1 | ch7_RES_0 |
| Value | | 1 | 1 | 1 | 1 | 0 | 1 | 0 | 1 |
| Description | 35 | ch7_VOD_2 | ch7_VOD_1 | ch7_VOD_0 | ch7_DEM_2 | ch7_DEM_1 | ch7_DEM_0 | ch7_Slow | ch7_idle_tha_1 |
| Value | | 1 | 0 | 1 | 0 | 1 | 0 | 0 | 0 |
| Description | 36 | ch7_idle_tha_0 | ch7_idle_thd_1 | ch7_idle_thd_0 | iph_dac_ns_1 | iph_dac_ns_0 | ipp_dac_ns_1 | ipp_dac_ns_0 | ipp_dac_1 |
| Value | | 0 | 0 | 0 | 0 | 0 | 0 | 0 | 0 |
| Description | 37 | ipp_dac_0 | RD23_67 | RD01_45 | RD_PD_ovrd | RD_Sel_test | RD_RESET_ovrd | PWDB_input_DC | DEM_VOD_ovrd |
| Value | | 0 | 0 | 0 | 0 | 0 | 0 | 0 | 0 |
| Description | 38 | DEM_ovrd_N2 | DEM_ovrd_N1 | DEM_ovrd_N0 | VOD_ovrd_N2 | VOD_ovrd_N1 | VOD_ovrd_N0 | SPARE0 | SPARE1 |
| Value | | 0 | 1 | 0 | 1 | 0 | 1 | 0 | 0 |
| Description | 39 | DEM__ovrd_S2 | DEM__ovrd_S1 | DEM_ovrd_S0 | VOD_ovrd_S2 | VOD_ovrd_S1 | VOD_ovrd_S0 | SPARE0 | SPARE1 |
| Value | | 0 | 1 | 0 | 1 | 0 | 1 | 0 | 0 |

Table 6. Example of EEPROM for 4 Devices Using 2 Address Maps⁽¹⁾

| EEPROM Address | Address (Hex) | EEPROM Data | Comments |
|----------------|---------------|-------------|--|
| 0 | 00 | 0x43 | CRC_EN = 0, Address Map = 1, >256 bytes = 0, Device Count[3:0] = 3 |
| 1 | 01 | 0x00 | |
| 2 | 02 | 0x08 | EEPROM Burst Size |
| 3 | 03 | 0x00 | CRC not used |
| 4 | 04 | 0x0B | Device 0 Address Location |
| 5 | 05 | 0x00 | CRC not used |
| 6 | 06 | 0x0B | Device 1 Address Location |
| 7 | 07 | 0x00 | CRC not used |
| 8 | 08 | 0x30 | Device 2 Address Location |
| 9 | 09 | 0x00 | CRC not used |
| 10 | 0A | 0x30 | Device 3 Address Location |
| 11 | 0B | 0x00 | Begin Device 0, 1 - Address Offset 3 |
| 12 | 0C | 0x00 | |
| 13 | 0D | 0x04 | |
| 14 | 0E | 0x07 | |
| 15 | 0F | 0x00 | |
| 16 | 10 | 0x00 | EQ CHB0 = 00 |
| 17 | 11 | 0xAB | VOD CHB0 = 1.0V |
| 18 | 12 | 0x00 | DEM CHB0 = 0 (0dB) |
| 19 | 13 | 0x00 | EQ CHB1 = 00 |
| 20 | 14 | 0x0A | VOD CHB1 = 1.0V |
| 21 | 15 | 0xB0 | DEM CHB1 = 0 (0dB) |
| 22 | 16 | 0x00 | |
| 23 | 17 | 0x00 | EQ CHB2 = 00 |
| 24 | 18 | 0xAB | VOD CHB2 = 1.0V |
| 25 | 19 | 0x00 | DEM CHB2 = 0 (0dB) |
| 26 | 1A | 0x00 | EQ CHB3 = 00 |
| 27 | 1B | 0x0A | VOD CHB3 = 1.0V |
| 28 | 1C | 0xB0 | DEM CHB3 = 0 (0dB) |
| 29 | 1D | 0x01 | |
| 30 | 1E | 0x80 | |
| 31 | 1F | 0x01 | EQ CHA0 = 00 |
| 32 | 20 | 0x56 | VOD CHA0 = 1.0V |
| 33 | 21 | 0x00 | DEM CHA0 = 0 (0dB) |
| 34 | 22 | 0x00 | EQ CHA1 = 00 |
| 35 | 23 | 0x15 | VOD CHA1 = 1.0V |
| 36 | 24 | 0x60 | DEM CHA1 = 0 (0dB) |
| 37 | 25 | 0x00 | |
| 38 | 26 | 0x01 | EQ CHA2 = 00 |
| 39 | 27 | 0x56 | VOD CHA2 = 1.0V |
| 40 | 28 | 0x00 | DEM CHA2 = 0 (0dB) |
| 41 | 29 | 0x00 | EQ CHA3 = 00 |
| 42 | 2A | 0x15 | VOD CHA3 = 1.0V |
| 43 | 2B | 0x60 | DEM CHA3 = 0 (0dB) |
| 44 | 2C | 0x00 | |
| 45 | 2D | 0x00 | |

(1) CRC_EN = 0, Address Map = 1, >256 byte = 0, Device Count[3:0] = 3. This example has all 8-channels set to EQ = 00 (min boost), VOD = 1.0V, DEM = 0 (0dB) and multiple device can point to the same address map.

Table 6. Example of EEPROM for 4 Devices Using 2 Address Maps⁽¹⁾ (continued)

| EEPROM Address | Address (Hex) | EEPROM Data | Comments |
|----------------|---------------|-------------|--------------------------------------|
| 46 | 2E | 0x54 | |
| 47 | 2F | 0x54 | End Device 0, 1 - Address Offset 39 |
| 48 | 30 | 0x00 | Begin Device 2, 3 - Address Offset 3 |
| 49 | 31 | 0x00 | |
| 50 | 32 | 0x04 | |
| 51 | 33 | 0x07 | |
| 52 | 34 | 0x00 | |
| 53 | 35 | 0x00 | EQ CHB0 = 00 |
| 54 | 36 | 0xAB | VOD CHB0 = 1.0V |
| 55 | 37 | 0x00 | DEM CHB0 = 0 (0dB) |
| 56 | 38 | 0x00 | EQ CHB1 = 00 |
| 57 | 39 | 0x0A | VOD CHB1 = 1.0V |
| 58 | 3A | 0xB0 | DEM CHB1 = 0 (0dB) |
| 59 | 3B | 0x00 | |
| 60 | 3C | 0x00 | EQ CHB2 = 00 |
| 61 | 3D | 0xAB | VOD CHB2 = 1.0V |
| 62 | 3E | 0x00 | DEM CHB2 = 0 (0dB) |
| 63 | 3F | 0x00 | EQ CHB3 = 00 |
| 64 | 40 | 0x0A | VOD CHB3 = 1.0V |
| 65 | 41 | 0xB0 | DEM CHB3 = 0 (0dB) |
| 66 | 42 | 0x01 | |
| 67 | 43 | 0x80 | |
| 68 | 44 | 0x01 | EQ CHA0 = 00 |
| 69 | 45 | 0x56 | VOD CHA0 = 1.0V |
| 70 | 46 | 0x00 | DEM CHA0 = 0 (0dB) |
| 71 | 47 | 0x00 | EQ CHA1 = 00 |
| 72 | 48 | 0x15 | VOD CHA1 = 1.0V |
| 73 | 49 | 0x60 | DEM CHA1 = 0 (0dB) |
| 74 | 4A | 0x00 | |
| 75 | 4B | 0x01 | EQ CHA2 = 00 |
| 76 | 4C | 0x56 | VOD CHA2 = 1.0V |
| 77 | 4D | 0x00 | DEM CHA2 = 0 (0dB) |
| 78 | 4E | 0x00 | EQ CHA3 = 00 |
| 79 | 4F | 0x15 | VOD CHA3 = 1.0V |
| 80 | 50 | 0x60 | DEM CHA3 = 0 (0dB) |
| 81 | 51 | 0x00 | |
| 82 | 52 | 0x00 | |
| 83 | 53 | 0x54 | |
| 84 | 54 | 0x54 | End Device 2, 3 - Address Offset 39 |

SYSTEM MANAGEMENT BUS (SMBus) and CONFIGURATION REGISTERS

The System Management Bus interface is compatible to SMBus 2.0 physical layer specification. ENSMB = 1kΩ to VDD to enable SMBus slave mode and allow access to the configuration registers.

The DS100KR401 has the AD[3:0] inputs in SMBus mode. These pins are the user set SMBUS slave address inputs. The AD[3:0] pins have internal pull-down. When left floating or pulled low the AD[3:0] = 0000'b, the device default address byte is B0'h. Based on the SMBus 2.0 specification, the DS100KR401 has a 7-bit slave address. The LSB is set to 0'b (for a WRITE). The device supports up to 16 address byte, which can be set with the AD[3:0] inputs. Below are the 16 addresses.

Table 7. Device Slave Address Bytes

| AD[3:0] Settings | Address Bytes (HEX) |
|------------------|---------------------|
| 0000 | B0 |
| 0001 | B2 |
| 0010 | B4 |
| 0011 | B6 |
| 0100 | B8 |
| 0101 | BA |
| 0110 | BC |
| 0111 | BE |
| 1000 | C0 |
| 1001 | C2 |
| 1010 | C4 |
| 1011 | C6 |
| 1100 | C8 |
| 1101 | CA |
| 1110 | CC |
| 1111 | CE |

The SDA, SCL pins are 3.3V tolerant, but are not 5V tolerant. External pull-up resistor is required on the SDA. The resistor value can be from 1 k Ω to 5 k Ω depending on the voltage, loading and speed. The SCL may also require an external pull-up resistor and it depends on the Host that drives the bus.

TRANSFER OF DATA VIA THE SMBus

During normal operation the data on SDA must be stable during the time when SCL is High.

There are three unique states for the SMBus:

START: A High-to-Low transition on SDA while SCL is High indicates a message START condition.

STOP: A Low-to-High transition on SDA while SCL is High indicates a message STOP condition.

IDLE: If SCL and SDA are both High for a time exceeding t_{BUF} from the last detected STOP condition or if they are High for a total exceeding the maximum specification for t_{HIGH} then the bus will transfer to the IDLE state.

SMBus TRANSACTIONS

The device supports WRITE and READ transactions. See Register Description table for register address, type (Read/Write, Read Only), default value and function information.

WRITING A REGISTER

To write a register, the following protocol is used (see SMBus 2.0 specification).

1. The Host drives a START condition, the 7-bit SMBus address, and a “0” indicating a WRITE.
2. The Device (Slave) drives the ACK bit (“0”).
3. The Host drives the 8-bit Register Address.
4. The Device drives an ACK bit (“0”).
5. The Host drive the 8-bit data byte.
6. The Device drives an ACK bit (“0”).
7. The Host drives a STOP condition.

The WRITE transaction is completed, the bus goes IDLE and communication with other SMBus devices may now occur.

READING A REGISTER

To read a register, the following protocol is used (see SMBus 2.0 specification).

1. The Host drives a START condition, the 7-bit SMBus address, and a “0” indicating a WRITE.
2. The Device (Slave) drives the ACK bit (“0”).
3. The Host drives the 8-bit Register Address.
4. The Device drives an ACK bit (“0”).
5. The Host drives a START condition.
6. The Host drives the 7-bit SMBus Address, and a “1” indicating a READ.
7. The Device drives an ACK bit “0”.
8. The Device drives the 8-bit data value (register contents).
9. The Host drives a NACK bit “1” indicating end of the READ transfer.
10. The Host drives a STOP condition.

The READ transaction is completed, the bus goes IDLE and communication with other SMBus devices may now occur.

Please see SMBus Register Map Table for more information.

Table 8. SMBUS Slave Mode Register Map

| Address | Register Name | Bit (s) | Field | Type | Default | Description |
|---------|--------------------|---------|---------------------|------|---------|--|
| 0x00 | Observation, Reset | 7 | Reserved | R/W | 0x00 | Set bit to 0. |
| | | 6:3 | Address Bit AD[3:0] | R | | Observation of AD[3:0] bit [6]: AD3 [5]: AD2 [4]: AD1 [3]: AD0 |
| | | 2 | EEPROM Read Done | R | | 1: Device completed the read from external EEPROM. |
| | | 1 | Block Reset | R/W | | 1: Block bit 0 from resetting the registers; self clearing. |
| | | 0 | Reset | R/W | | SMBus Reset 1: Reset registers to default value; self clearing. |
| 0x01 | PWDN Channels | 7:0 | PWDN CHx | R/W | 0x00 | Power Down per Channel [7]: CH7 – CHA_3 [6]: CH6 – CHA_2 [5]: CH5 – CHA_1 [4]: CH4 – CHA_0 [3]: CH3 – CHB_3 [2]: CH2 – CHB_2 [1]: CH1 – CHB_1 [0]: CH0 – CHB_0 00'h = all channels enabled FF'h = all channels disabled Note: override RESET pin. |

Table 8. SMBUS Slave Mode Register Map (continued)

| Address | Register Name | Bit (s) | Field | Type | Default | Description |
|---------|---------------------------------|---------|-----------------------------|------|---------|---|
| 0x02 | Override RESET, LPBK Control | 7:6 | Reserved | R/W | 0x00 | Set bits to 0. |
| | | 5:4 | LPBK Control | | | 00: Use LPBK pin control 01: INA to OUTB loopback 10: INB to OUTA loopback 11: Disable loopback and ignore LPBK pin. |
| | | 3:1 | Reserved | | | Set bits to 0. |
| | | 0 | Override RESET | | | 1: Block RESET pin control 0: Allow RESET pin control |
| 0x05 | Slave Mode CRC Bits | 7:0 | CRC bits | R/W | 0x00 | CRC bits [7:0] |
| 0x06 | Slave CRC Control | 7:5 | Reserved | R/W | 0x10 | Set bits to 0. |
| | | 4 | Reserved | | | Set bit to 1. |
| | | 3 | Slave CRC | | | 1: Disables the slave CRC mode 0: Enables the slave CRC mode Note: In order to change VOD, DEM and EQ of the channels in slave mode, set bit to 1 to disable the CRC. |
| | | 2:0 | Reserved | | | Set bits to 0. |
| 0x08 | Override Pin Control | 7 | Reserved | R/W | 0x00 | Set bit to 0. |
| | | 6 | Override SD_TH | | | 1: Block SD_TH pin control 0: Allow SD_TH pin control |
| | | 5:2 | Reserved | | | Set bits to 0. |
| | | 1 | Override DEM | | | 1: Block DEM pin control 0: Allow DEM pin control |
| | | 0 | Reserved | | | Set bit to 0. |
| 0x0E | CH0 - CHB0 Reserved | 7:0 | Reserved | R/W | 0x00 | Set bits to 0. |
| 0x0F | CH0 - CHB0 EQ | 7:0 | EQ Control | R/W | 0x2F | IB0 EQ Control - total of 256 levels. See Table 2 . |
| 0x10 | CH0 - CHB0 VOD | 7 | Short Circuit Protection | R/W | 0xAD | 1: Enable the short circuit protection 0: Disable the short circuit protection |
| | | 6 | Reserved | | | Set bit to 0. |
| | | 5:3 | Reserved | | | Set bits to default value - 101. |
| | | 2:0 | VOD Control | | | OB0 VOD Control 000: 0.7 V 001: 0.8 V 010: 0.9 V 011: 1.0 V 100: 1.1 V 101: 1.2 V (default) 110: 1.3 V 111: 1.4 V |
| 0x11 | CH0 - CHB0 DEM | 7 | STATUS | R | 0x02 | Observation bit for CH0 - CHB0. |
| | | 6:5 | STATUS | R | | Observation bit for CH0 - CHB0. |
| | | 4:3 | Reserved | R/W | | Set bits to 0. |
| | | 2:0 | DEM Control | R/W | | OB0 DEM Control 000: 0 dB 001: -1.5 dB 010: -3.5 dB (default) 011: -5 dB 100: -6 dB 101: -8 dB 110: -9 dB 111: -12 dB |

Table 8. SMBUS Slave Mode Register Map (continued)

| Address | Register Name | Bit (s) | Field | Type | Default | Description |
|---------|------------------------------|---------|-----------------------------|------|---------|---|
| 0x12 | CH0 - CHB0 IDLE Threshold | 7:4 | Reserved | R/W | 0x00 | Set bits to 0. |
| | | 3:2 | IDLE thd | | | De-assert threshold 00 = 110 mVp-p (default) 01 = 100 mVp-p 10 = 150 mVp-p 11 = 130 mVp-p Note: override the SD_TH pin. |
| | | 1:0 | IDLE tha | | | Assert threshold 00 = 180 mVp-p (default) 01 = 160 mVp-p 10 = 210 mVp-p 11 = 190 mVp-p Note: override the SD_TH pin. |
| 0x15 | CH1 - CHB1 Reserved | 7:0 | Reserved | R/W | 0x00 | Set bits to 0. |
| 0x16 | CH1 - CHB1 EQ | 7:0 | EQ Control | R/W | 0x2F | IB1 EQ Control - total of 256 levels. See Table 2 . |
| 0x17 | CH1 - CHB1 VOD | 7 | Short Circuit Protection | R/W | 0xAD | 1: Enable the short circuit protection 0: Disable the short circuit protection |
| | | 6 | Reserved | | | Set bit to 0. |
| | | 5:3 | Reserved | | | Set bits to default value - 101. |
| | | 2:0 | VOD Control | | | OB1 VOD Control 000: 0.7 V 001: 0.8 V 010: 0.9 V 011: 1.0 V 100: 1.1 V 101: 1.2 V (default) 110: 1.3 V 111: 1.4 V |
| 0x18 | CH1 - CHB1 DEM | 7 | STATUS | R | 0x02 | Observation bit for CH1 - CHB1. |
| | | 6:5 | STATUS | R | | Observation bit for CH1 - CHB1. |
| | | 4:3 | Reserved | R/W | | Set bits to 0. |
| | | 2:0 | DEM Control | R/W | | OB1 DEM Control 000: 0 dB 001: -1.5 dB 010: -3.5 dB (default) 011: -5 dB 100: -6 dB 101: -8 dB 110: -9 dB 111: -12 dB |
| 0x19 | CH1 - CHB1 IDLE Threshold | 7:4 | Reserved | R/W | 0x00 | Set bits to 0. |
| | | 3:2 | IDLE thd | | | De-assert threshold 00 = 110 mVp-p (default) 01 = 100 mVp-p 10 = 150 mVp-p 11 = 130 mVp-p Note: override the SD_TH pin. |
| | | 1:0 | IDLE tha | | | Assert threshold 00 = 180 mVp-p (default) 01 = 160 mVp-p 10 = 210 mVp-p 11 = 190 mVp-p Note: override the SD_TH pin. |
| 0x1C | CH2 - CHB2 Reserved | 7:0 | Reserved | R/W | 0x00 | Set bits to 0. |
| 0x1D | CH2 - CHB2 EQ | 7:0 | EQ Control | R/W | 0x2F | IB2 EQ Control - total of 256 levels. See Table 2 . |

Table 8. SMBUS Slave Mode Register Map (continued)

| Address | Register Name | Bit (s) | Field | Type | Default | Description |
|---------|------------------------------|---------|--------------------------|------|---------|---|
| 0x1E | CH2 - CHB2 VOD | 7 | Short Circuit Protection | R/W | 0xAD | 1: Enable the short circuit protection 0: Disable the short circuit protection |
| | | 6 | Reserved | | | Set bit to 0. |
| | | 5:3 | Reserved | | | Set bits to default value - 101. |
| | | 2:0 | VOD Control | | | OB2 VOD Control 000: 0.7 V 001: 0.8 V 010: 0.9 V 011: 1.0 V 100: 1.1 V 101: 1.2 V (default) 110: 1.3 V 111: 1.4 V |
| 0x1F | CH2 - CHB2 DEM | 7 | STATUS | R | 0x02 | Observation bit for CH2 - CHB2. |
| | | 6:5 | STATUS | R | | Observation bit for CH2 - CHB2. |
| | | 4:3 | Reserved | R/W | | Set bits to 0. |
| | | 2:0 | DEM Control | R/W | | OB2 DEM Control 000: 0 dB 001: -1.5 dB 010: -3.5 dB (default) 011: -5 dB 100: -6 dB 101: -8 dB 110: -9 dB 111: -12 dB |
| 0x20 | CH2 - CHB2 IDLE Threshold | 7:4 | Reserved | R/W | 0x00 | Set bits to 0. |
| | | 3:2 | IDLE thd | | | De-assert threshold 00 = 110 mVp-p (default) 01 = 100 mVp-p 10 = 150 mVp-p 11 = 130 mVp-p Note: override the SD_TH pin. |
| | | 1:0 | IDLE tha | | | Assert threshold 00 = 180 mVp-p (default) 01 = 160 mVp-p 10 = 210 mVp-p 11 = 190 mVp-p Note: override the SD_TH pin. |
| 0x23 | CH3 - CHB3 Reserved | 7:0 | Reserved | R/W | 0x00 | Set bits to 0. |
| 0x24 | CH3 - CHB3 EQ | 7:0 | EQ Control | R/W | 0x2F | IB3 EQ Control - total of 256 levels. See Table 2 . |
| 0x25 | CH3 - CHB3 VOD | 7 | Short Circuit Protection | R/W | 0xAD | 1: Enable the short circuit protection 0: Disable the short circuit protection |
| | | 6 | Reserved | | | Set bit to 0. |
| | | 5:3 | Reserved | | | Set bits to default value - 101. |
| | | 2:0 | VOD Control | | | OB0 VOD Control 000: 0.7 V 001: 0.8 V 010: 0.9 V 011: 1.0 V 100: 1.1 V 101: 1.2 V (default) 110: 1.3 V 111: 1.4 V |

Table 8. SMBUS Slave Mode Register Map (continued)

| Address | Register Name | Bit (s) | Field | Type | Default | Description |
|---------|------------------------------|---------|-----------------------------|------|---------|---|
| 0x26 | CH3 - CHB3 DEM | 7 | STATUS | R | 0x02 | Observation bit for CH3 - CHB3. |
| | | 6:5 | STATUS | R | | Observation bit for CH3 - CHB3. |
| | | 4:3 | Reserved | R/W | | Set bits to 0. |
| | | 2:0 | DEM Control | R/W | | OB3 DEM Control 000: 0 dB 001: -1.5 dB 010: -3.5 dB (default) 011: -5 dB 100: -6 dB 101: -8 dB 110: -9 dB 111: -12 dB |
| 0x27 | CH3 - CHB3 IDLE Threshold | 7:4 | Reserved | R/W | 0x00 | Set bits to 0. |
| | | 3:2 | IDLE thd | | | De-assert threshold 00 = 110 mVp-p (default) 01 = 100 mVp-p 10 = 150 mVp-p 11 = 130 mVp-p Note: override the SD_TH pin. |
| | | 1:0 | IDLE tha | | | Assert threshold 00 = 180 mVp-p (default) 01 = 160 mVp-p 10 = 210 mVp-p 11 = 190 mVp-p Note: override the SD_TH pin. |
| 0x2B | CH4 - CHA0 Reserved | 7:0 | Reserved | R/W | 0x00 | Set bits to 0. |
| 0x2C | CH4 - CHA0 EQ | 7:0 | EQ Control | R/W | 0x2F | IA0 EQ Control - total of 256 levels. See Table 2 . |
| 0x2D | CH4 - CHA0 VOD | 7 | Short Circuit Protection | R/W | 0xAD | 1: Enable the short circuit protection 0: Disable the short circuit protection |
| | | 6 | Reserved | | | Set bit to 0. |
| | | 5:3 | Reserved | | | Set bits to default value - 101. |
| | | 2:0 | VOD Control | | | OA0 VOD Control 000: 0.7 V 001: 0.8 V 010: 0.9 V 011: 1.0 V 100: 1.1 V 101: 1.2 V (default) 110: 1.3 V 111: 1.4 V |
| 0x2E | CH4 - CHA0 DEM | 7 | STATUS | R | 0x02 | Observation bit for CH4 - CHA0. |
| | | 6:5 | STATUS | R | | Observation bit for CH4 - CHA0. |
| | | 4:3 | Reserved | R/W | | Set bits to 0. |
| | | 2:0 | DEM Control | R/W | | OA0 DEM Control 000: 0 dB 001: -1.5 dB 010: -3.5 dB (default) 011: -5 dB 100: -6 dB 101: -8 dB 110: -9 dB 111: -12 dB |

Table 8. SMBUS Slave Mode Register Map (continued)

| Address | Register Name | Bit (s) | Field | Type | Default | Description |
|---------|------------------------------|---------|-----------------------------|------|---------|---|
| 0x2F | CH4 - CHA0 IDLE Threshold | 7:4 | Reserved | R/W | 0x00 | Set bits to 0. |
| | | 3:2 | IDLE thd | | | De-assert threshold 00 = 110 mVp-p (default) 01 = 100 mVp-p 10 = 150 mVp-p 11 = 130 mVp-p Note: override the SD_TH pin. |
| | | 1:0 | IDLE tha | | | Assert threshold 00 = 180 mVp-p (default) 01 = 160 mVp-p 10 = 210 mVp-p 11 = 190 mVp-p Note: override the SD_TH pin. |
| 0x32 | CH5 - CHA1 Reserved | 7:0 | Reserved | R/W | 0x00 | Set bits to 0. |
| 0x33 | CH5 - CHA1 EQ | 7:0 | EQ Control | R/W | 0x2F | IA1 EQ Control - total of 256 levels. See Table 2 . |
| 0x34 | CH5 - CHA1 VOD | 7 | Short Circuit Protection | R/W | 0xAD | 1: Enable the short circuit protection 0: Disable the short circuit protection |
| | | 6 | Reserved | | | Set bit to 0. |
| | | 5:3 | Reserved | | | Set bits to default value - 101. |
| | | 2:0 | VOD Control | | | OA1 VOD Control 000: 0.7 V 001: 0.8 V 010: 0.9 V 011: 1.0 V 100: 1.1 V 101: 1.2 V (default) 110: 1.3 V 111: 1.4 V |
| 0x35 | CH5 - CHA1 DEM | 7 | STATUS | R | 0x02 | Observation bit for CH5 - CHA1. |
| | | 6:5 | STATUS | R | | Observation bit for CH5 - CHA1. |
| | | 4:3 | Reserved | R/W | | Set bits to 0. |
| | | 2:0 | DEM Control | R/W | | OA1 DEM Control 000: 0 dB 001: -1.5 dB 010: -3.5 dB (default) 011: -5 dB 100: -6 dB 101: -8 dB 110: -9 dB 111: -12 dB |
| 0x36 | CH5 - CHA1 IDLE Threshold | 7:4 | Reserved | R/W | 0x00 | Set bits to 0. |
| | | 3:2 | IDLE thd | | | De-assert threshold 00 = 110 mVp-p (default) 01 = 100 mVp-p 10 = 150 mVp-p 11 = 130 mVp-p Note: override the SD_TH pin. |
| | | 1:0 | IDLE tha | | | Assert threshold 00 = 180 mVp-p (default) 01 = 160 mVp-p 10 = 210 mVp-p 11 = 190 mVp-p Note: override the SD_TH pin. |
| 0x39 | CH6 - CHA2 Reserved | 7:0 | Reserved | R/W | 0x00 | Set bits to 0. |
| 0x3A | CH6 - CHA2 EQ | 7:0 | EQ Control | R/W | 0x2F | IA2 EQ Control - total of 256 levels. See Table 2 . |

Table 8. SMBUS Slave Mode Register Map (continued)

| Address | Register Name | Bit (s) | Field | Type | Default | Description |
|---------|------------------------------|---------|--------------------------|------|---------|---|
| 0x3B | CH6 - CHA2 VOD | 7 | Short Circuit Protection | R/W | 0xAD | 1: Enable the short circuit protection 0: Disable the short circuit protection |
| | | 6 | Reserved | | | Set bit to 0. |
| | | 5:3 | Reserved | | | Set bits to default value - 101. |
| | | 2:0 | VOD Control | | | OA2 VOD Control 000: 0.7 V 001: 0.8 V 010: 0.9 V 011: 1.0 V 100: 1.1 V 101: 1.2 V (default) 110: 1.3 V 111: 1.4 V |
| 0x3C | CH6 - CHA2 DEM | 7 | STATUS | R | 0x02 | Observation bit for CH6 - CHA2. |
| | | 6:5 | STATUS | R | | Observation bit for CH6 - CHA2. |
| | | 4:3 | Reserved | R/W | | Set bits to 0. |
| | | 2:0 | DEM Control | R/W | | OA2 DEM Control 000: 0 dB 001: -1.5 dB 010: -3.5 dB (default) 011: -5 dB 100: -6 dB 101: -8 dB 110: -9 dB 111: -12 dB |
| 0x3D | CH6 - CHA2 IDLE Threshold | 7:4 | Reserved | R/W | 0x00 | Set bits to 0. |
| | | 3:2 | IDLE thd | | | De-assert threshold 00 = 110 mVp-p (default) 01 = 100 mVp-p 10 = 150 mVp-p 11 = 130 mVp-p Note: override the SD_TH pin. |
| | | 1:0 | IDLE tha | | | Assert threshold 00 = 180 mVp-p (default) 01 = 160 mVp-p 10 = 210 mVp-p 11 = 190 mVp-p Note: override the SD_TH pin. |
| 0x40 | CH7 - CHA3 Reserved | 7:0 | Reserved | R/W | 0x00 | Set bits to 0. |
| 0x41 | CH7 - CHA3 EQ | 7:0 | EQ Control | R/W | 0x2F | IA3 EQ Control - total of 256 levels. See Table 2 . |
| 0x42 | CH7 - CHA3 VOD | 7 | Short Circuit Protection | R/W | 0xAD | 1: Enable the short circuit protection 0: Disable the short circuit protection |
| | | 6 | Reserved | | | Set bit to 0. |
| | | 5:3 | Reserved | | | Set bits to default value - 101. |
| | | 2:0 | VOD Control | | | OA3 VOD Control 000: 0.7 V 001: 0.8 V 010: 0.9 V 011: 1.0 V 100: 1.1 V 101: 1.2 V (default) 110: 1.3 V 111: 1.4 V |

Table 8. SMBUS Slave Mode Register Map (continued)

| Address | Register Name | Bit (s) | Field | Type | Default | Description |
|---------|------------------------------|---------|-------------|------|---------|---|
| 0x43 | CH7 - CHA3 DEM | 7 | STATUS | R | 0x02 | Observation bit for CH7 - CHA3. |
| | | 6:5 | STATUS | R | | Observation bit for CH7 - CHA3. |
| | | 4:3 | Reserved | R/W | | Set bits to 0. |
| | | 2:0 | DEM Control | R/W | | OA3 DEM Control 000: 0 dB 001: -1.5 dB 010: -3.5 dB (default) 011: -5 dB 100: -6 dB 101: -8 dB 110: -9 dB 111: -12 dB |
| 0x44 | CH7 - CHA3 IDLE Threshold | 7:4 | Reserved | R/W | 0x00 | Set bits to 0. |
| | | 3:2 | IDLE thd | | | De-assert threshold 00 = 110 mVp-p (default) 01 = 100 mVp-p 10 = 150 mVp-p 11 = 130 mVp-p Note: override the SD_TH pin. |
| | | 1:0 | IDLE tha | | | Assert threshold 00 = 180 mVp-p (default) 01 = 160 mVp-p 10 = 210 mVp-p 11 = 190 mVp-p Note: override the SD_TH pin. |
| 0x51 | Device ID | 7:5 | VERSION | R | 0x44 | 010'b |
| | | 4:0 | ID | | | 00100'b |

APPLICATIONS INFORMATION

GENERAL RECOMMENDATIONS

The DS100KR401 is a high performance circuit capable of delivering excellent performance. Careful attention must be paid to the details associated with high-speed design as well as providing a clean power supply. Refer to the information below and Revision 4 of the LVDS Owner's Manual for more detailed information on high speed design tips to address signal integrity design issues.

PCB LAYOUT CONSIDERATIONS FOR DIFFERENTIAL PAIRS

The CML inputs and outputs have been optimized to work with interconnects using a controlled differential impedance of 85 - 100Ω. It is preferable to route differential lines exclusively on one layer of the board, particularly for the input traces. The use of vias should be avoided if possible. If vias must be used, they should be used sparingly and must be placed symmetrically for each side of a given differential pair. Whenever differential vias are used the layout must also provide for a low inductance path for the return currents as well. Route the differential signals away from other signals and noise sources on the printed circuit board. See AN-1187 ([SNOA401](#)) for additional information on WQFN packages.

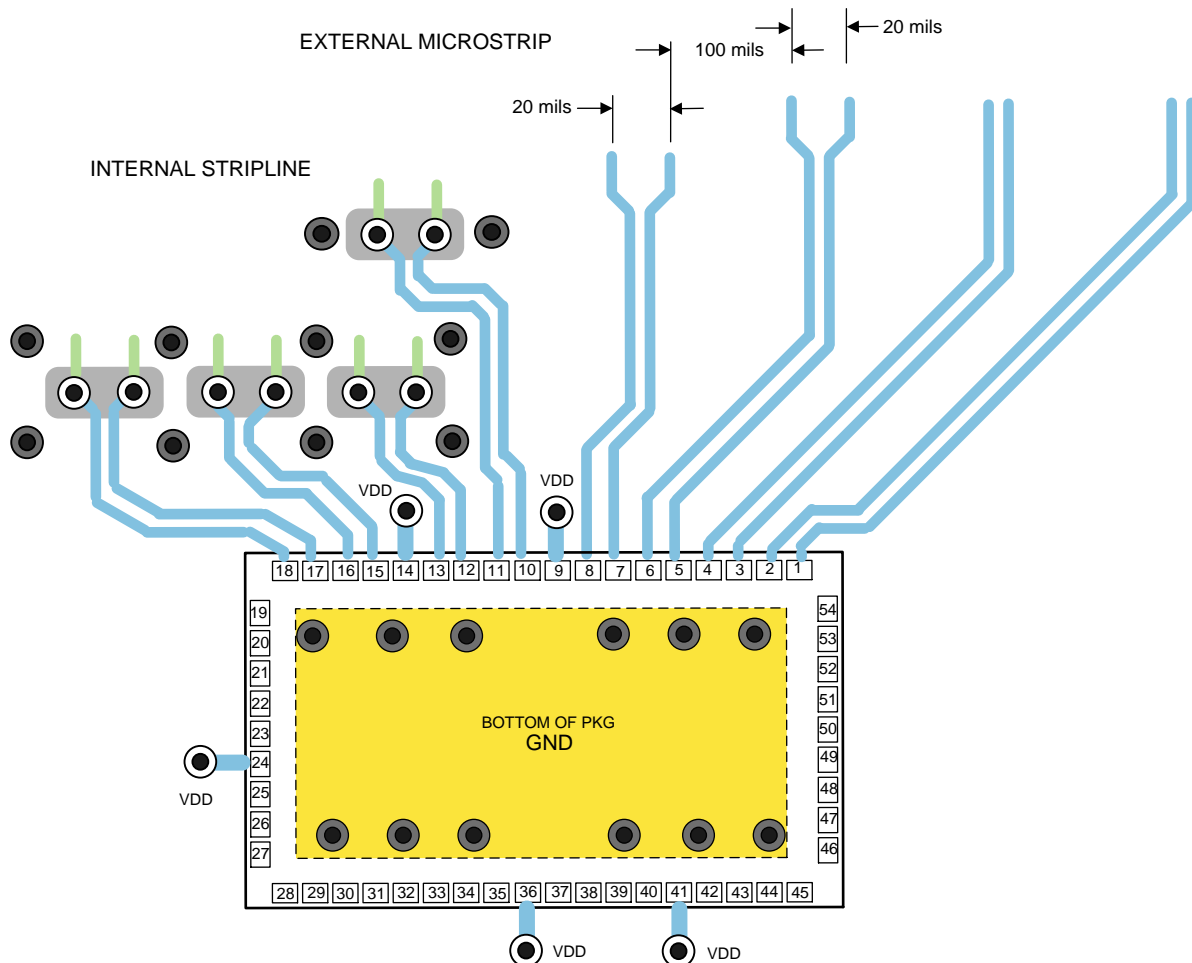

Figure 6. Typical Routing Options

The graphic shown above depicts different transmission line topologies which can be used in various combinations to achieve the optimal system performance. Impedance discontinuities at the differential via can be minimized or eliminated by increasing the swell around each hole and providing for a low inductance return current path. When the via structure is associated with thick backplane PCB, further optimization such as back drilling is often used to reduce the detrimental high frequency effects of stubs on the signal path.

POWER SUPPLY BYPASSING

Two approaches are recommended to ensure that the DS100KR401 is provided with an adequate power supply. First, the supply (VDD) and ground (GND) pins should be connected to power planes routed on adjacent layers of the printed circuit board. The layer thickness of the dielectric should be minimized so that the V_{DD} and GND planes create a low inductance supply with distributed capacitance. Second, careful attention to supply bypassing through the proper use of bypass capacitors is required. A 0.1 μF bypass capacitor should be connected to each V_{DD} pin such that the capacitor is placed as close as possible to the DS100KR401. Smaller body size capacitors can help facilitate proper component placement. In the case of 3.3V mode operation with the internal LDO regulator, recommend using capacitors with capacitance in the range of 1.0 μF to 10 μF should be incorporated in the power supply bypassing design for the VIN pin. These capacitors should be ultra-low ESR ceramic.

TYPICAL CHARACTERISTICS

Typical Performance Curves Characteristics

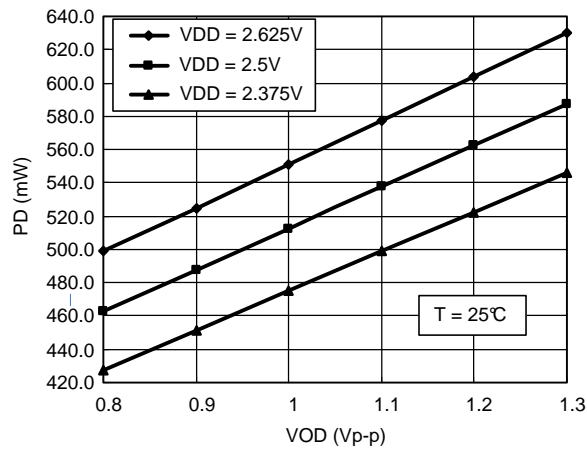

Figure 7. Power Dissipation (PD) vs. Output Differential Voltage (VOD)

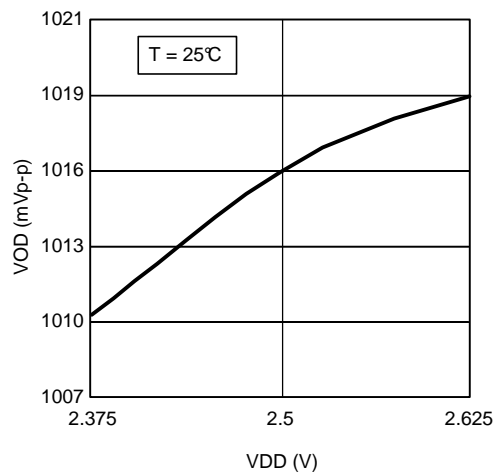

Figure 8. Output Differential Voltage (VOD = 1.0 Vp-p) vs. Supply Voltage (VDD)

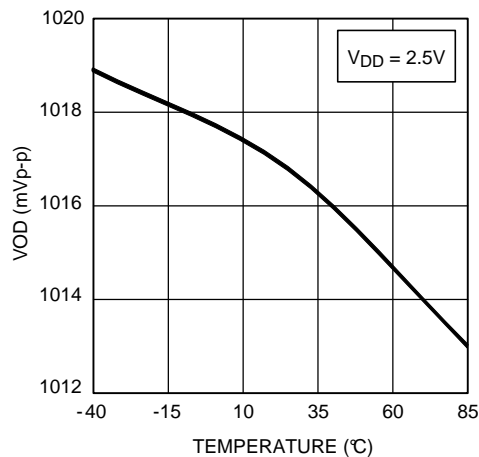

Figure 9. Output Differential Voltage (VOD = 1.0 Vp-p) vs. Temperature

TYPICAL CHARACTERISTICS (continued)

Typical Performance Eye Diagrams Characteristics

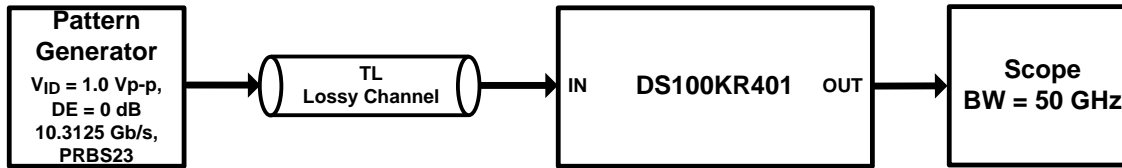

Figure 10. Test Setup Connections Diagram

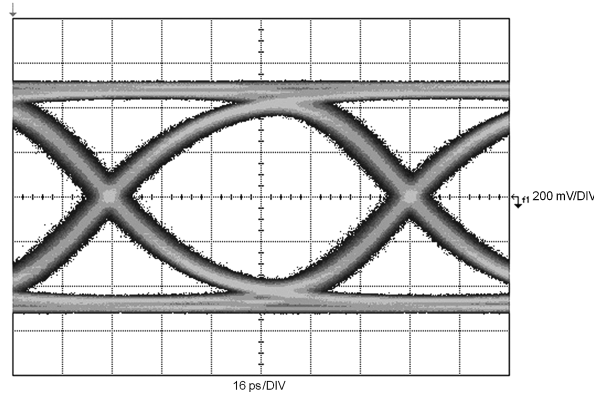

Figure 11. TL = 20 inch 4-mil FR4 trace, DS100KR401 settings: EQ[1:0] = R, R = 15'h, DEM[1:0] = float, float

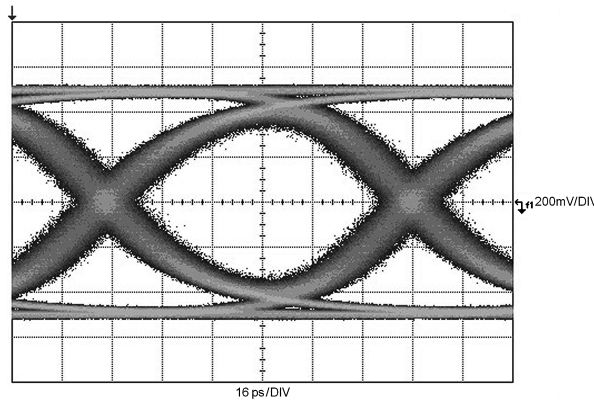

Figure 12. TL = 30 inch 4-mil FR4 trace, DS100KR401 settings: EQ[1:0] = float, R = 1F'h, DEM[1:0] = float, float

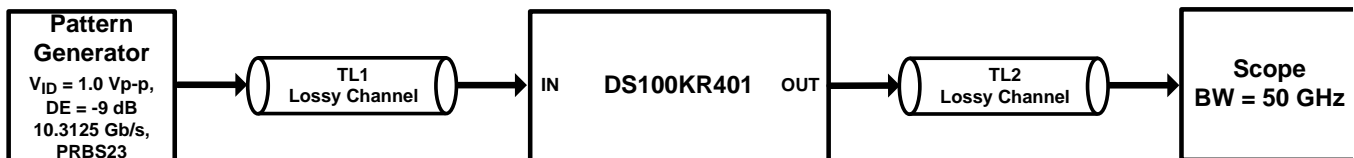

Figure 13. Test Setup Connections Diagram

TYPICAL CHARACTERISTICS (continued)

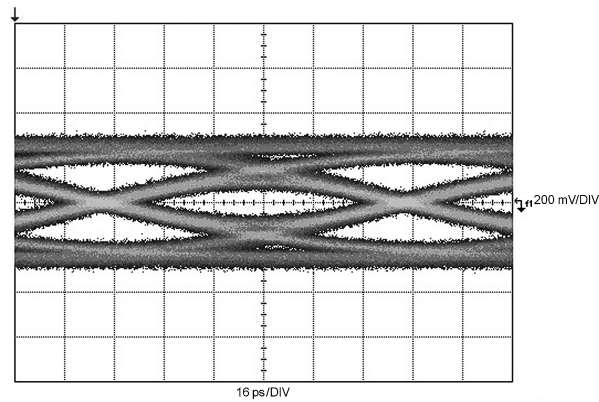

Figure 14. TL1 = 20 inch 4-mil FR4 trace, TL2 = 15 inch 4-mil FR4 trace, DS100KR401 settings: EQ[1:0] = R, R = 15'h, DEM[1:0] = float, float

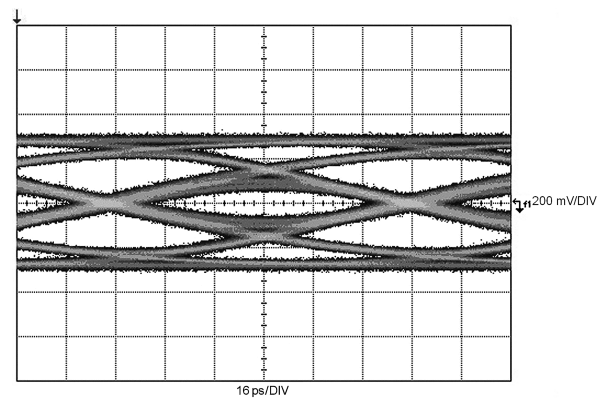

Figure 15. TL1 = 30 inch 4-mil FR4 trace, TL2 = 15 inch 4-mil FR4 trace, DS100KR401 settings: EQ[1:0] = float, R = 1F'h, DEM[1:0] = float, float

PACKAGING INFORMATION

| Orderable Device | Status (1) | Package Type | Package Drawing | Pins | Package Qty | Eco Plan (2) | Lead/Ball Finish (6) | MSL Peak Temp (3) | Op Temp (°C) | Device Marking (4/5) | Samples |
|--------------------|---------------|--------------|-----------------|------|-------------|-------------------------|-------------------------|----------------------|--------------|-------------------------|-------------------------|
| DS100KR401SQ/NOPB | ACTIVE | WQFN | NJY | 54 | 2000 | Green (RoHS & no Sb/Br) | SN | Level-2-260C-1 YEAR | -40 to 85 | DS100KR401SQ | Samples |
| DS100KR401SQE/NOPB | ACTIVE | WQFN | NJY | 54 | 250 | Green (RoHS & no Sb/Br) | SN | Level-2-260C-1 YEAR | -40 to 85 | DS100KR401SQ | Samples |

(1) The marketing status values are defined as follows:

ACTIVE: Product device recommended for new designs.

LIFEBUY: TI has announced that the device will be discontinued, and a lifetime-buy period is in effect.

NRND: Not recommended for new designs. Device is in production to support existing customers, but TI does not recommend using this part in a new design.

PREVIEW: Device has been announced but is not in production. Samples may or may not be available.

OBSELETE: TI has discontinued the production of the device.

(2) **RoHS:** TI defines "RoHS" to mean semiconductor products that are compliant with the current EU RoHS requirements for all 10 RoHS substances, including the requirement that RoHS substance do not exceed 0.1% by weight in homogeneous materials. Where designed to be soldered at high temperatures, "RoHS" products are suitable for use in specified lead-free processes. TI may reference these types of products as "Pb-Free".

RoHS Exempt: TI defines "RoHS Exempt" to mean products that contain lead but are compliant with EU RoHS pursuant to a specific EU RoHS exemption.

Green: TI defines "Green" to mean the content of Chlorine (Cl) and Bromine (Br) based flame retardants meet JS709B low halogen requirements of <=1000ppm threshold. Antimony trioxide based flame retardants must also meet the <=1000ppm threshold requirement.

(3) MSL, Peak Temp. - The Moisture Sensitivity Level rating according to the JEDEC industry standard classifications, and peak solder temperature.

(4) There may be additional marking, which relates to the logo, the lot trace code information, or the environmental category on the device.

(5) Multiple Device Markings will be inside parentheses. Only one Device Marking contained in parentheses and separated by a "-" will appear on a device. If a line is indented then it is a continuation of the previous line and the two combined represent the entire Device Marking for that device.

(6) Lead/Ball Finish - Orderable Devices may have multiple material finish options. Finish options are separated by a vertical ruled line. Lead/Ball Finish values may wrap to two lines if the finish value exceeds the maximum column width.

Important Information and Disclaimer:The information provided on this page represents TI's knowledge and belief as of the date that it is provided. TI bases its knowledge and belief on information provided by third parties, and makes no representation or warranty as to the accuracy of such information. Efforts are underway to better integrate information from third parties. TI has taken and continues to take reasonable steps to provide representative and accurate information but may not have conducted destructive testing or chemical analysis on incoming materials and chemicals. TI and TI suppliers consider certain information to be proprietary, and thus CAS numbers and other limited information may not be available for release.

In no event shall TI's liability arising out of such information exceed the total purchase price of the TI part(s) at issue in this document sold by TI to Customer on an annual basis.

TAPE AND REEL INFORMATION



QUADRANT ASSIGNMENTS FOR PIN 1 ORIENTATION IN TAPE

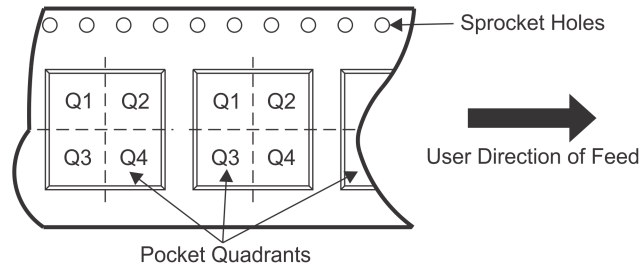

*All dimensions are nominal

| Device | Package Type | Package Drawing | Pins | SPQ | Reel Diameter (mm) | Reel Width W1 (mm) | A0 (mm) | B0 (mm) | K0 (mm) | P1 (mm) | W (mm) | Pin1 Quadrant |
|--------------------|--------------|-----------------|------|------|--------------------|--------------------|---------|---------|---------|---------|--------|---------------|
| DS100KR401SQ/NOPB | WQFN | NJY | 54 | 2000 | 330.0 | 16.4 | 5.8 | 10.3 | 1.0 | 12.0 | 16.0 | Q1 |
| DS100KR401SQE/NOPB | WQFN | NJY | 54 | 250 | 178.0 | 16.4 | 5.8 | 10.3 | 1.0 | 12.0 | 16.0 | Q1 |

TAPE AND REEL BOX DIMENSIONS



*All dimensions are nominal

| Device | Package Type | Package Drawing | Pins | SPQ | Length (mm) | Width (mm) | Height (mm) |
|--------------------|--------------|-----------------|------|------|-------------|------------|-------------|
| DS100KR401SQ/NOPB | WQFN | NJY | 54 | 2000 | 367.0 | 367.0 | 38.0 |
| DS100KR401SQE/NOPB | WQFN | NJY | 54 | 250 | 210.0 | 185.0 | 35.0 |

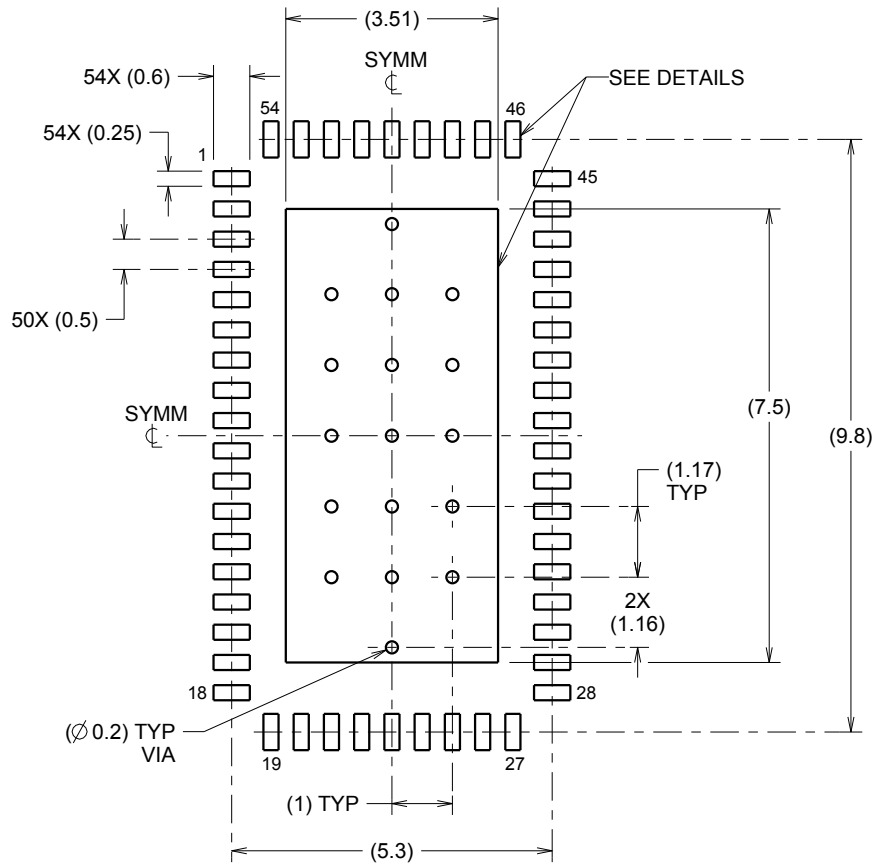

LAND PATTERN EXAMPLE
SCALE:8X

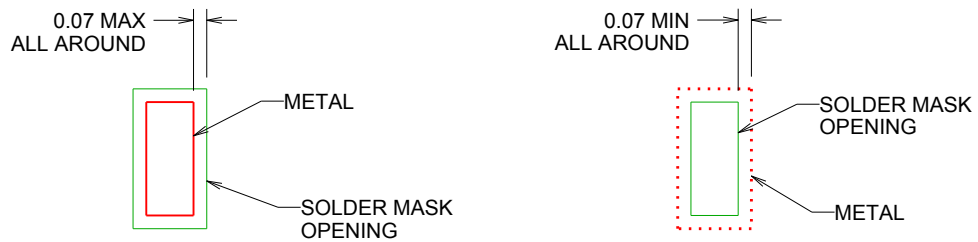

SOLDER MASK DETAILS

4214993/A 07/2013

NOTES: (continued)

- This package is designed to be soldered to a thermal pad on the board. For more information, refer to QFN/SON PCB application note in literature No. SLUA271 (www.ti.com/lit/slua271).

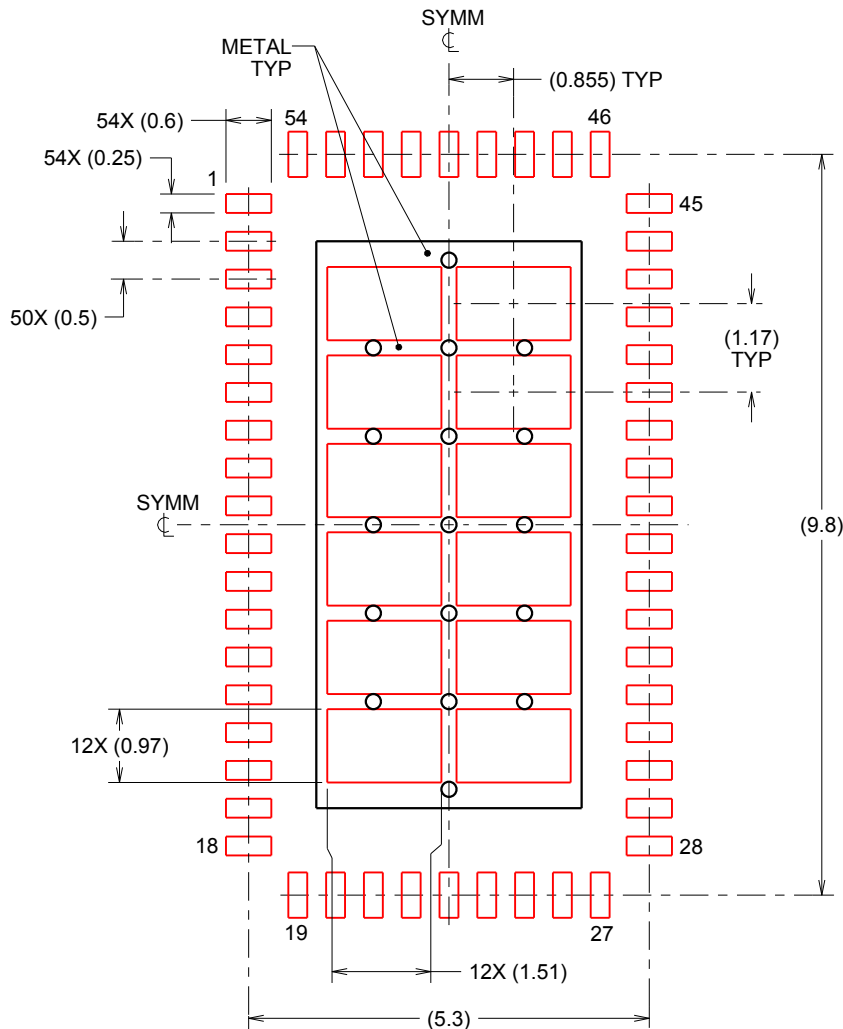

SOLDERPASTE EXAMPLE
 BASED ON 0.125mm THICK STENCIL

EXPOSED PAD
 67% PRINTED SOLDER COVERAGE BY AREA
 SCALE:10X

4214993/A 07/2013

NOTES: (continued)

- 5. Laser cutting apertures with trapezoidal walls and rounded corners may offer better paste release. IPC-7525 may have alternate design recommendations.

IMPORTANT NOTICE AND DISCLAIMER

TI PROVIDES TECHNICAL AND RELIABILITY DATA (INCLUDING DATASHEETS), DESIGN RESOURCES (INCLUDING REFERENCE DESIGNS), APPLICATION OR OTHER DESIGN ADVICE, WEB TOOLS, SAFETY INFORMATION, AND OTHER RESOURCES "AS IS" AND WITH ALL FAULTS, AND DISCLAIMS ALL WARRANTIES, EXPRESS AND IMPLIED, INCLUDING WITHOUT LIMITATION ANY IMPLIED WARRANTIES OF MERCHANTABILITY, FITNESS FOR A PARTICULAR PURPOSE OR NON-INFRINGEMENT OF THIRD PARTY INTELLECTUAL PROPERTY RIGHTS.

These resources are intended for skilled developers designing with TI products. You are solely responsible for (1) selecting the appropriate TI products for your application, (2) designing, validating and testing your application, and (3) ensuring your application meets applicable standards, and any other safety, security, or other requirements. These resources are subject to change without notice. TI grants you permission to use these resources only for development of an application that uses the TI products described in the resource. Other reproduction and display of these resources is prohibited. No license is granted to any other TI intellectual property right or to any third party intellectual property right. TI disclaims responsibility for, and you will fully indemnify TI and its representatives against, any claims, damages, costs, losses, and liabilities arising out of your use of these resources.

TI's products are provided subject to TI's Terms of Sale (www.ti.com/legal/termsofsale.html) or other applicable terms available either on ti.com or provided in conjunction with such TI products. TI's provision of these resources does not expand or otherwise alter TI's applicable warranties or warranty disclaimers for TI products.

Mailing Address: Texas Instruments, Post Office Box 655303, Dallas, Texas 75265
Copyright © 2020, Texas Instruments Incorporated