

# LTC3256EMSE

## Dual Output 350mA Step-Down Charge Pump with Watchdog Timer

### DESCRIPTION

Demonstration circuit 2375A is a dual output 350mA step-down charge pump with a watchdog timer featuring the [LTC®3256EMSE](http://www.linear.com/product/LTC3256EMSE). The LTC3256 operates with a wide input voltage range from 5.5V to 38V and is engineered for diagnostic coverage in ISO262262 systems. The LTC3256 can provide up to 350mA of output current from a 12V battery with 2W less power dissipation than 2 ideal LDOs. The DC2375A was populated with automotive grade components for evaluation.

The LTC3256 data sheet gives a complete description of the device, operation and application information. The data sheet must be read in conjunction with this demo manual.

**Design files for this circuit board are available at <http://www.linear.com/demo/DC2375A>**

LT, LT, LTC, LTM, Linear Technology and the Linear logo are registered trademarks of Linear Technology Corporation. All other trademarks are the property of their respective owners.

### PERFORMANCE SUMMARY Specifications are at T<sub>A</sub> = 25°C

SYMBOL	PARAMETER	CONDITIONS	MIN	TYP	MAX	UNITS
V <sub>IN</sub>	V <sub>IN</sub> Input Voltage Range		5.5		38	V
V <sub>IN EMI</sub>	V <sub>IN</sub> EMI Filter Input		5.5		38	V
V <sub>OUT5</sub>	OUT5 Output Voltage	0mA ≤ I <sub>OUT5</sub> ≤ 100mA, V <sub>IN</sub> = 12V	4.85	5.05	5.19	V
V <sub>OUT3</sub>	OUT3 Output Voltage	0mA ≤ I <sub>OUT3</sub> ≤ 100mA, V <sub>IN</sub> = 12V	3.200	3.30	3.366	V

### BOARD PHOTO

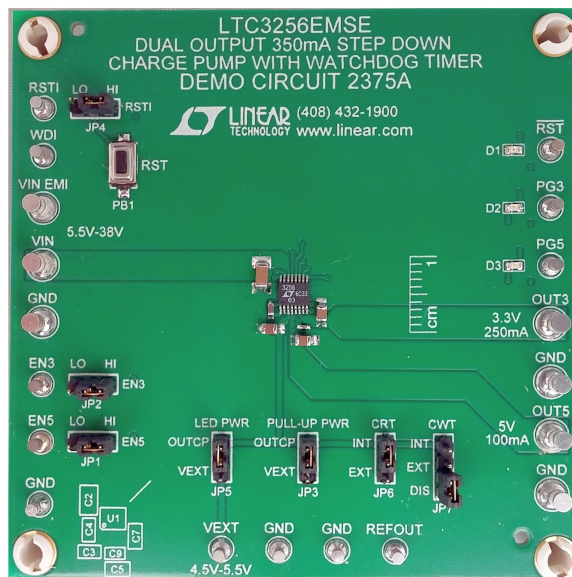

Figure 1.

## TYPICAL APPLICATIONS

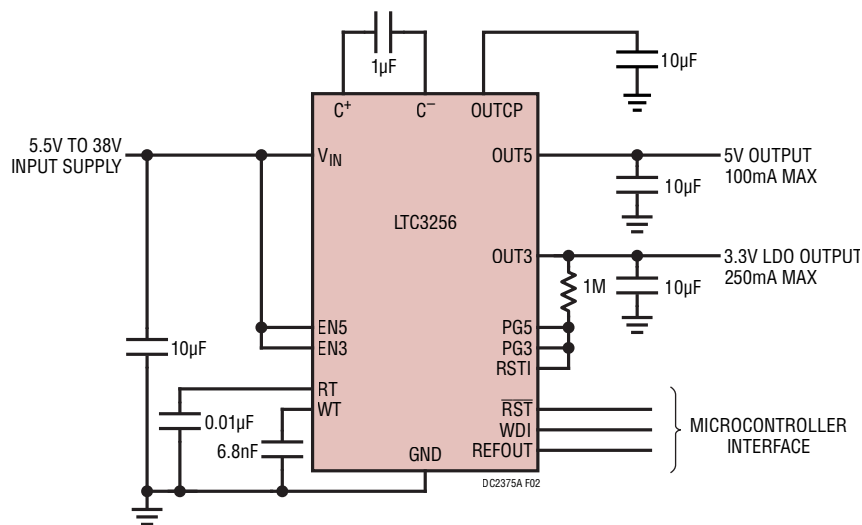

Figure 2. High Efficiency Dual Output Power Supply

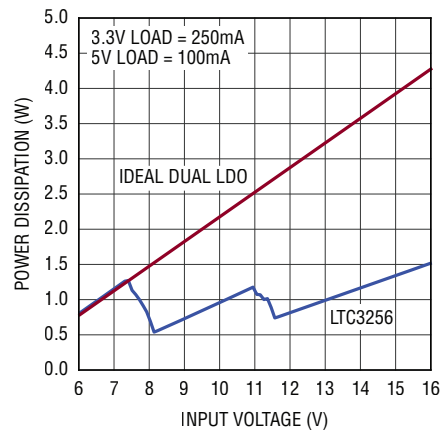

Figure 3. Power Dissipation vs Input Voltage

## QUICK START PROCEDURE

Refer to Figure 4 for the proper measurement equipment setup and jumper settings and follow the procedure below.

NOTE: When measuring the input or output voltage ripple, care must be taken to avoid a long ground lead on the oscilloscope probe. Measure the input or output voltage ripple by touching the probe tip directly across the  $V_{IN}$  or  $V_{OUT}$  and GND terminals. See Figure 5 for proper scope probe technique.

1. Make sure the jumper settings are as follows:

JP1: EN5 is on the HI position

JP2: EN3 is on the HI position

JP3: PULL-UP PWR is on the OUTCP position

JP4: RST1 is on the HI position

JP5: LED PWR is on the OUTCP position

JP6: CRT is set to INT position

JP7: CWT is set to the DIS position

2. Turn on and set PS1 to 12V.

3. Slowly increase the load OUT3 to 250mA and observe the output ripple and the output voltage on OUT3.

4. Slowly increase the load OUT5 to 100mA and observe the output ripple and the output voltage on OUT5.

5. Observe that  $I_{IN}$  is approximately  $\frac{1}{2}$  the total output current of 350mA plus the PG5, PG3 LED and  $I_Q$  currents.

Note: Change the PULL-UP PWR and LED PWR jumpers (JP3, JP5) to the  $V_{EXT}$  position to observe  $I_{IN}$  without the added LED and resistor pull-up current. A 5V supply can be connected to the  $V_{EXT}$  terminals to power the LEDs and pull-up the open drain outputs.

6. Decrease  $V_{IN}$  to 8V and observe that  $I_{IN}$  increased by about 50mA. OUT5 is now powered by  $V_{IN}$ .

7. Decrease  $V_{IN}$  to 5.5V and observe that  $I_{IN}$  has increased to about another 125mA. The charge pump is now in 1:1 mode.

8. Press and hold the RST pushbutton switch, PB1, and observe the RST LED illuminates.

9. Release the RST pushbutton.

10. Move the CWT jumper, JP7 from the DIS position to the INT positions and observe that the RST LED pulses on and off.

## QUICK START PROCEDURE

11. Set a pulse generator with a 0 to 5V pulse and a 100ms to 1 second period on the WDI pin and observe that the RST LED extinguishes.
12. Decrease the pulse period below 35ms and observe the RST LED pulses again.
13. Slowly increase the pulse period to above 2s and observed that the RST LED stops pulsing when the period is between about 60ms and 1.3s and starts to pulse again above 2s.
14. Turn off the loads and supply when done evaluation.

NOTE: The reset time and watchdog time can be adjusted using external capacitors if desired. Place the respective jumper, CRT or CWT, to the EXT position. The external capacitors populated on this board are 2.2nF to provide the external time listed in the data sheet. Optional capacitor pads, C10 and C13, are placed in parallel on the bottom side of the board to allow additional capacitance to be easily added to increase the RST or WDT times.

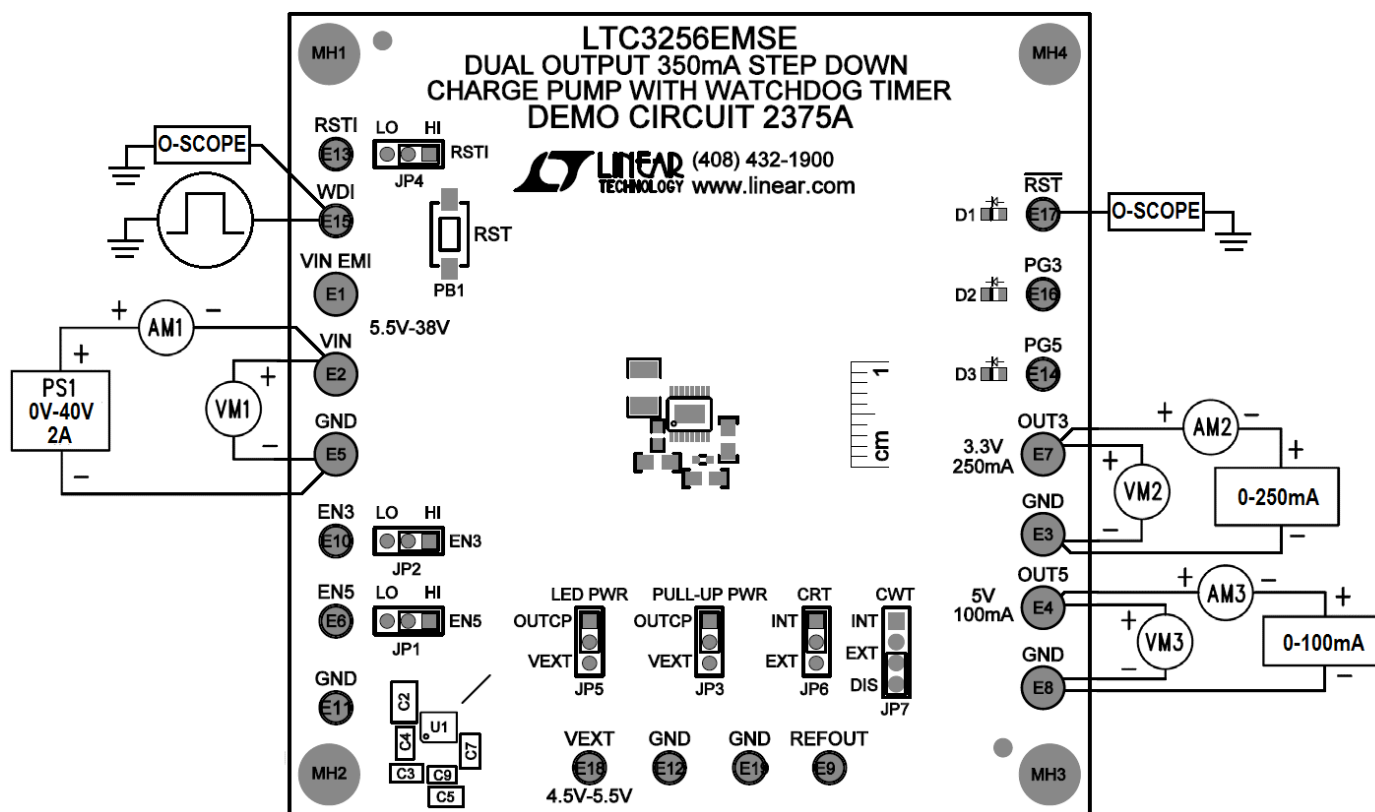

Figure 4. Proper Measurement Equipment Setup for DC2375A

## QUICK START PROCEDURE

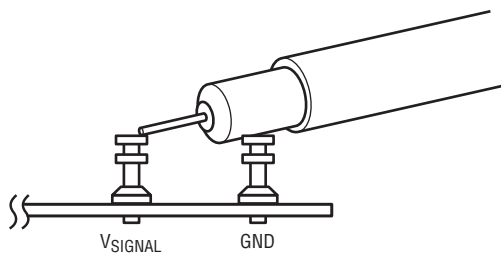

Figure 5. Measuring Input or Output Ripple

## APPLICATIONS INFORMATION

Figure 6 illustrates how the input current changes as the input voltage increases. Figure 7 illustrates how the

efficiency and power loss changes as the input voltage increases.

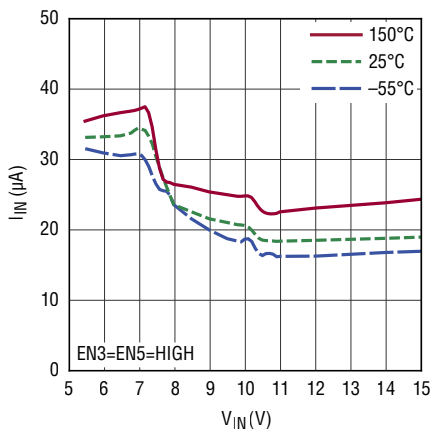

Figure 6. Input Operating Current vs Input Voltage

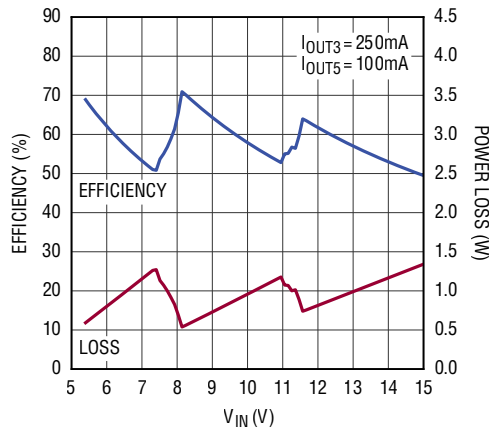
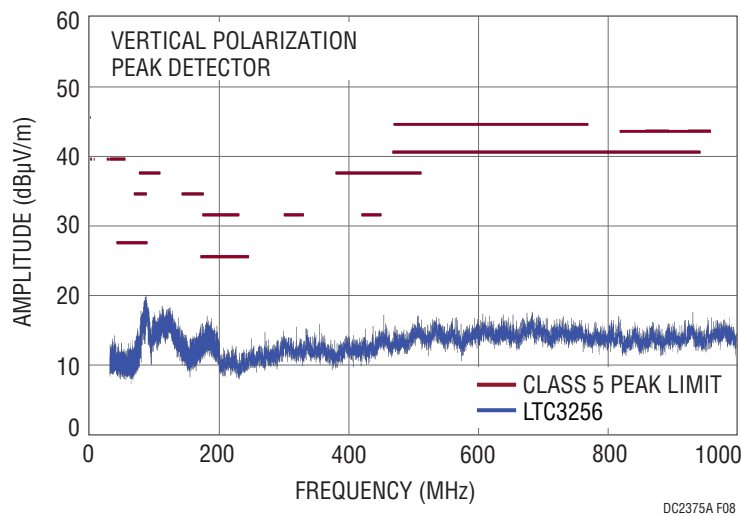

Figure 7. Efficiency and Power Loss vs Input Voltage

## APPLICATIONS INFORMATION

Figure 8 and Figure 9 illustrate the radiated emission performance without an EMI filter on the  $V_{IN}$  input. These tests were performed to CISPR 25 Class 5 peak limits and were conducted using a 14V input, a 47 $\Omega$  resistor

on OUT5 and a 13 $\Omega$  resistor on OUT3. Linear Technology has made every effort to provide useful and accurate EMI data, but it remains the responsibility of the customer to ensure product compliance.



DC2375A DEMO BOARD  
(WITHOUT EMI FILTER)  
14V INPUT TO 5V AT 100mA  
AND 3.3V AT 250mA

Figure 8. Radiated  $V_{IN}$  without Filter Vertical Peak Data

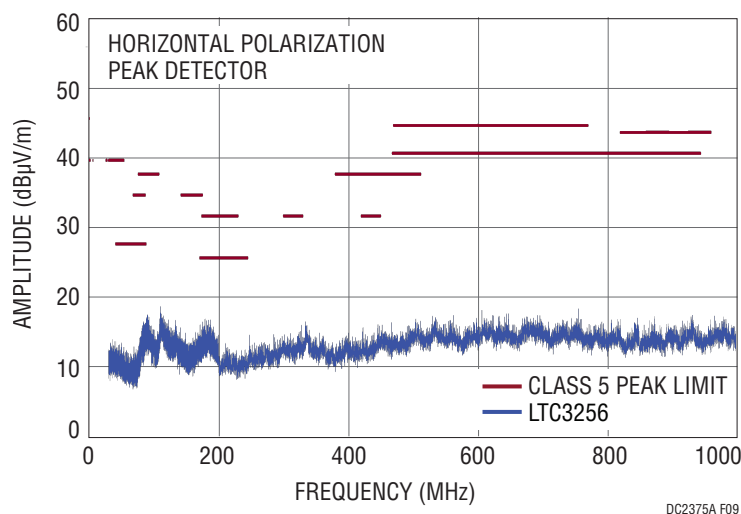

DC2375A DEMO BOARD  
(WITHOUT EMI FILTER)  
14V INPUT TO 5V AT 100mA  
AND 3.3V AT 250mA

Figure 9. Radiated  $V_{IN}$  without Filter Horizontal Peak Data

# DEMO MANUAL DC2375A

## PARTS LIST

ITEM	QTY	REFERENCE	PART DESCRIPTION	MANUFACTURER/PART NUMBER
<b>Required Circuit Components</b>				
1	1	C2	CAP, CHIP, X5R, 10 $\mu$ F, $\pm$ 10%, 50V, 1206	TDK, CGA5L3X5R1H106K160AB
	0	C2 (ALTERNATE)	CAP, CHIP, X7S, 10 $\mu$ F, $\pm$ 10%, 50V, 1210	MURATA, GCM32EC71H106KA03
2	3	C3, C5, C7	CAP, CHIP, X7R, 10 $\mu$ F, $\pm$ 10%, 6.3V, 0805	TDK, CGA4J1X7R0J106K125AC
3	1	C4	CAP, CHIP, X7R, 1 $\mu$ F, $\pm$ 10%, 16V, 0603	TDK, CGA3E1X7R1C105K080AC
4	1	C9	CAP, CHIP, X7R, 0.1 $\mu$ F, $\pm$ 10%, 16V, 0402	TDK, CGAB1X7R1C104K050BC
5	1	U1	DUAL OUTPUT 350mA STEP DOWN CHARGE PUMP WITH WATCHDOG TIMER	LINEAR TECH., LTC3256EMSE#PBF
<b>Additional Demo Board Circuit Components</b>				
6	3	C1, C14, C15	CAP, CHIP, X7S, 10 $\mu$ F, $\pm$ 10%, 50V, 1210	MURATA, GCM32EC71H106KA03
7	0	C6, C8, C10, C13 OPT	CAP, CHIP, 0603	
8	2	C11, C12	CAP, CHIP, X7R, 2.2nF, $\pm$ 10%, 50V, 0402	TDK, CGA2BX7R1H222K050BA
9	1	D1	DIODE, LED, SUPER RED DIFF, 0603 SMD	LUMEX, SML-LX0603SRW-TR
10	2	D2, D3	DIODE, LED, SUPER GREEN DIFF, 0603 SMD	LITE-ON, LTST-C190KGKT
11	1	FB1	FERRITE, CHIP, 60 $\Omega$ at 100MHz, 3.5A, 0603	TDK, MPZ1608S600ATDH5
12	1	L1	IND, CHIP, 0.22 $\mu$ H, 0.027 $\Omega$ , 2.4A, 1210	TDK, NLCV32T-R22M-ERFD
13	1	M1	MOSFET, P-CHN, 12V, SOT-23	VISHAY, SI2333DDS-T1-GE3
14	2	M2, M3	MOSFET, N-CHN, 20V, SOT-23	VISHAY, SI2374DS-T1-GE3
15	1	PB1	SWITCH, PUSH BUTTON, SMT	C & K, PTS635SL25SMTRLFS
16	6	R1, R3, R5-R8	RES 100k $\Omega$ 1/16W 5% 0402 SMD	VISHAY, CRCW0402100KJNED
17	7	R2, R4, R10, R11, R13-R15	RES 1k $\Omega$ 1/16W 5% 0402 SMD	VISHAY, CRCW04021K00JNED
18	2	R9, R12	RES 1M $\Omega$ 1/16W 5% 0402 SMD	VISHAY, CRCW04021M00JNED
<b>Hardware: For Demo Board Only</b>				
19	5	JP1-JP5	HEADER, 3 PIN 1 ROW .079CC	WURTH ELEKTRONIK, 62000311121
20	2	JP6, JP7	HEADER, 4 PIN 1 ROW .079CC	WURTH ELEKTRONIK, 62000411121
21	7	JP1-JP7	SHUNT, 2mm	WURTH ELEKTRONIK, 60800213421
22	7	E1-E5, E7, E8	TP, TURRET, 0.094", PBF	MILL-MAX, 2501-2-00-80-00-00-07-0
23	12	E6, E9-E9	TURRET, 0.061 DIA	MILL-MAX, 2308-2-00-80-00-00-07-0
24	4	MH1-MH4	STAND-OFF, NYLON 0.375" TALL	KEYSTONE, 8832 (SNAP ON)

SCHEMATIC DIAGRAM

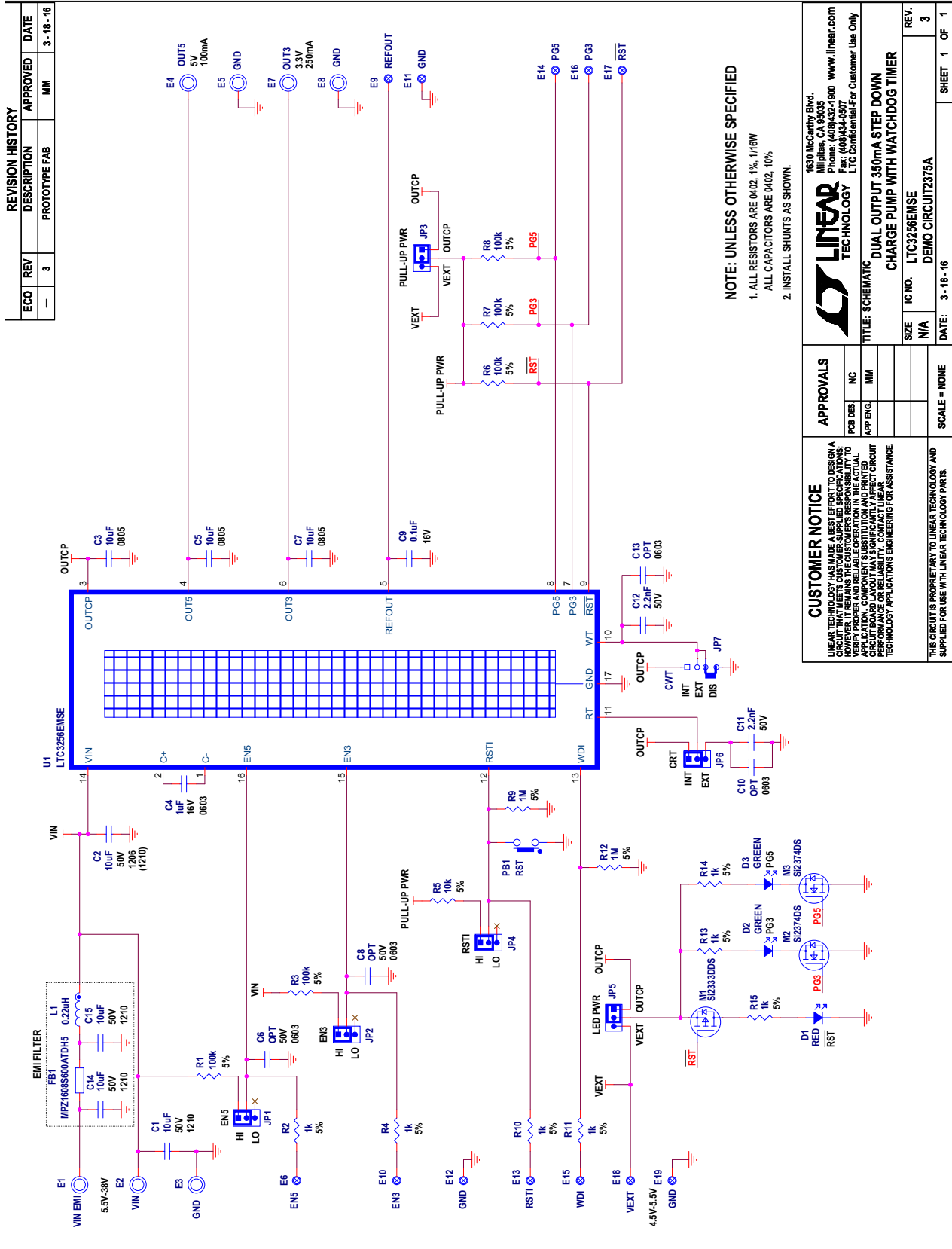

dc2375afa

# DEMO MANUAL DC2375A

---

## DEMONSTRATION BOARD IMPORTANT NOTICE

Linear Technology Corporation (LTC) provides the enclosed product(s) under the following **AS IS** conditions:

This demonstration board (DEMO BOARD) kit being sold or provided by Linear Technology is intended for use for **ENGINEERING DEVELOPMENT OR EVALUATION PURPOSES ONLY** and is not provided by LTC for commercial use. As such, the DEMO BOARD herein may not be complete in terms of required design-, marketing-, and/or manufacturing-related protective considerations, including but not limited to product safety measures typically found in finished commercial goods. As a prototype, this product does not fall within the scope of the European Union directive on electromagnetic compatibility and therefore may or may not meet the technical requirements of the directive, or other regulations.

If this evaluation kit does not meet the specifications recited in the DEMO BOARD manual the kit may be returned within 30 days from the date of delivery for a full refund. **THE FOREGOING WARRANTY IS THE EXCLUSIVE WARRANTY MADE BY THE SELLER TO BUYER AND IS IN LIEU OF ALL OTHER WARRANTIES, EXPRESSED, IMPLIED, OR STATUTORY, INCLUDING ANY WARRANTY OF MERCHANTABILITY OR FITNESS FOR ANY PARTICULAR PURPOSE. EXCEPT TO THE EXTENT OF THIS INDEMNITY, NEITHER PARTY SHALL BE LIABLE TO THE OTHER FOR ANY INDIRECT, SPECIAL, INCIDENTAL, OR CONSEQUENTIAL DAMAGES.**

The user assumes all responsibility and liability for proper and safe handling of the goods. Further, the user releases LTC from all claims arising from the handling or use of the goods. Due to the open construction of the product, it is the user's responsibility to take any and all appropriate precautions with regard to electrostatic discharge. Also be aware that the products herein may not be regulatory compliant or agency certified (FCC, UL, CE, etc.).

No License is granted under any patent right or other intellectual property whatsoever. **LTC assumes no liability for applications assistance, customer product design, software performance, or infringement of patents or any other intellectual property rights of any kind.**

LTC currently services a variety of customers for products around the world, and therefore this transaction **is not exclusive**.

**Please read the DEMO BOARD manual prior to handling the product.** Persons handling this product must have electronics training and observe good laboratory practice standards. **Common sense is encouraged.**

This notice contains important safety information about temperatures and voltages. For further safety concerns, please contact a LTC application engineer.

Mailing Address:

Linear Technology  
1630 McCarthy Blvd.  
Milpitas, CA 95035

Copyright © 2004, Linear Technology Corporation