

---

## Si3454 EVALUATION KIT USER'S GUIDE

---

### 1. Introduction

The Si3454 8-port evaluation kit (Si3454-KIT) is intended for Power over Ethernet (PoE) Power Sourcing Equipment (PSE) system designers interested in evaluating the 4-port Si3454 PSE controller.

The Si3454 is controlled through an I<sup>2</sup>C (or SMBus) interface. For convenience in evaluation, a graphical user interface (GUI) is provided, giving an easy-to-use visual display and control of the Si3454 I<sup>2</sup>C registers. The evaluation kit assumes the user has access to a PC to control the evaluation board using the provided GUI.

The user is also responsible for providing an appropriate high-voltage power supply. The power supply should be 45 to 57 V for normal PoE or 51 to 57 V for PoE+. The Si3454 can supply over 30 W to each port. Thus, the two Si3454 controllers for the 8-port demo system can provide over 240 W of total power. Normally, a 50 to 100 W power supply is used. While the classification and actual current consumption of each port is available, the demo GUI interacts with the Si3454 on a per-port basis and does not implement system-level power management. Contact Silicon Laboratories for more information about system-level power management options.

The Si3454-KIT kit has been thoroughly tested for standards compliance and interoperability. Contact Silicon Laboratories for test reports using Sifos PoE test equipment and University of New Hampshire PoE standards compliance and interoperability reports.

# Si3454-KIT

## 2. Kit Contents

**Table 1. Evaluation Kit Contents**

Qty	Item	Contents
1	Si3454-EVB	Si3454 8-port evaluation board with connector for an external 50 V power supply. The power supply must be capable of supplying the required amount of power for all PoE loads being connected. The board is populated with Si3454 parts.
1	Si3459CB-EVB	RJ-45 connector board configured as Power over Ethernet mid-span injector with gigabit Ethernet pass-through.
1	RIBBON-20-4	20-wire cable connects the Si3454 evaluation board to the RJ-45 connector board
1	USB-ADAPT-BRD	USB to I <sup>2</sup> C (or SMBus) translator board. This board is preprogrammed to support I <sup>2</sup> C transactions. The label on this 2"x 2" board is "PoE USB Adapter".
1	S-USB2.06-01	USB cable to connect to a host PC
2	Si3402ISO-EVB	Powered Device evaluation board configured to provide a Class 3 signature.
1	Si3402ISO-C4-EVB	Powered Device evaluation board configured to provide a Class 4 signature.
3	LOADBOARD_REV1_0	Configurable load board.
6	HEXNUT 1/4-32_NIC	Nuts for attaching load boards to powered device evaluation boards
1	CON-2-MALE	Power connector to fit EVB J3
3	CAT5E-01	Ethernet cable to connect the Si3402 evaluation boards to the connector board.
1	CD-ROM	Software drivers for the USB to I <sup>2</sup> C adapter and a GUI for the Si3454 registers on a CD-ROM. Applicable notes and data sheets are also included.

## 3. Installation

This KIT contains a PC-based Monitor GUI. Before you can use the Monitor, you must first install the device driver associated with the PoE USB Adapter card (called “PoEUSB” in this document), then install the Monitor GUI.

### 3.1. Installing the PoEUSB Device

**Note:** If you have previously installed the PoEUSB device, uninstall the previous driver version before installing the new version. To uninstall the previous version, select “Programs and Features” or “Add or Remove Programs” from the Control Panel, and then uninstall “Windows Driver Package - Silicon Labs, (WinUSB) MultiportSerial” and similar file names.

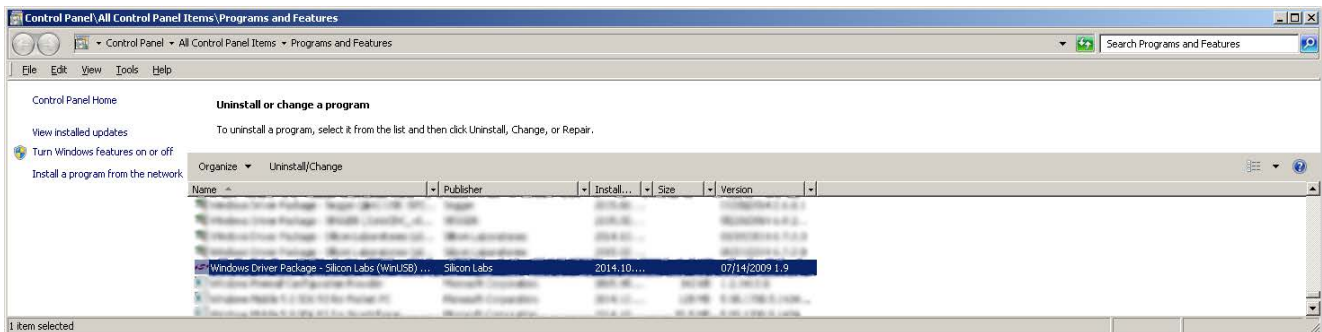

**Figure 1. Uninstall Previous Revision Windows Driver Package**

To install the PoEUSB device driver, run PoEUSBSetup.exe from the documentation that comes with this KIT.

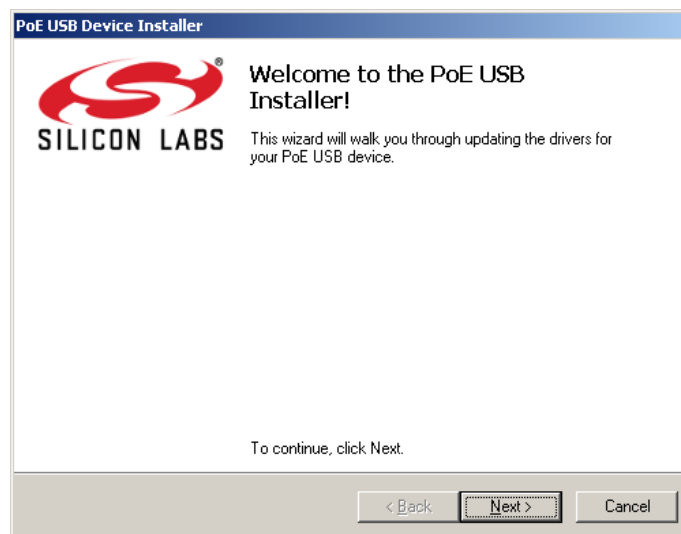

**Figure 2. PoE USB Device Installer Screen**

After the PoEUSB device driver is installed, then complete the installation by connecting the PoEUSB adapter card to the PC with a USB cable.

# Si3454-KIT

## 3.2. Installing the Si3454 & Si3459 Monitor

If you have previously installed the Monitor, uninstall the previous version before installing the new version. To uninstall the previous version, select “Programs and Features” or “Add or Remove Programs” from the Control Panel, and then uninstall the outdated application.

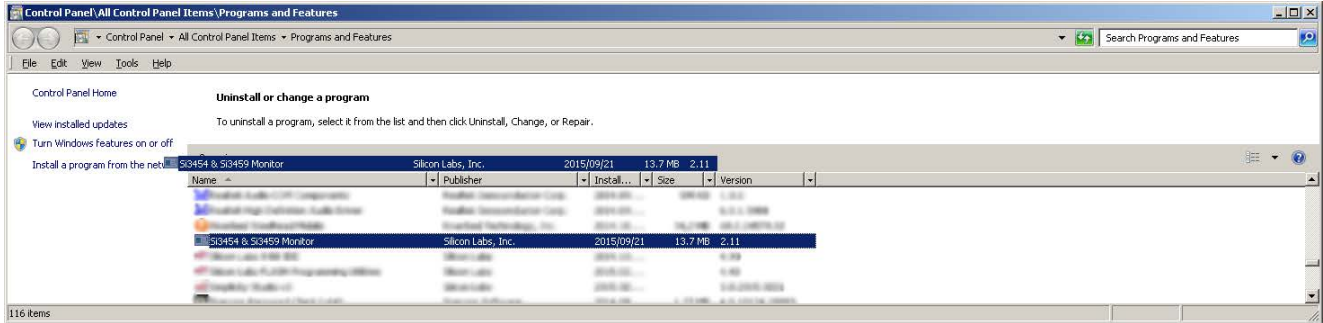

**Figure 3. Uninstall Previous Rev Si3454 & Si3459 Monitor**

To install the Si3454 & Si3459 Monitor, run si3454\_si3459\_monitor.msi.



**Figure 4. Monitor Setup Wizard**

## 4. Hardware Installation

Figure 5 shows how all the hardware components of the Si3454 evaluation kit fit together.

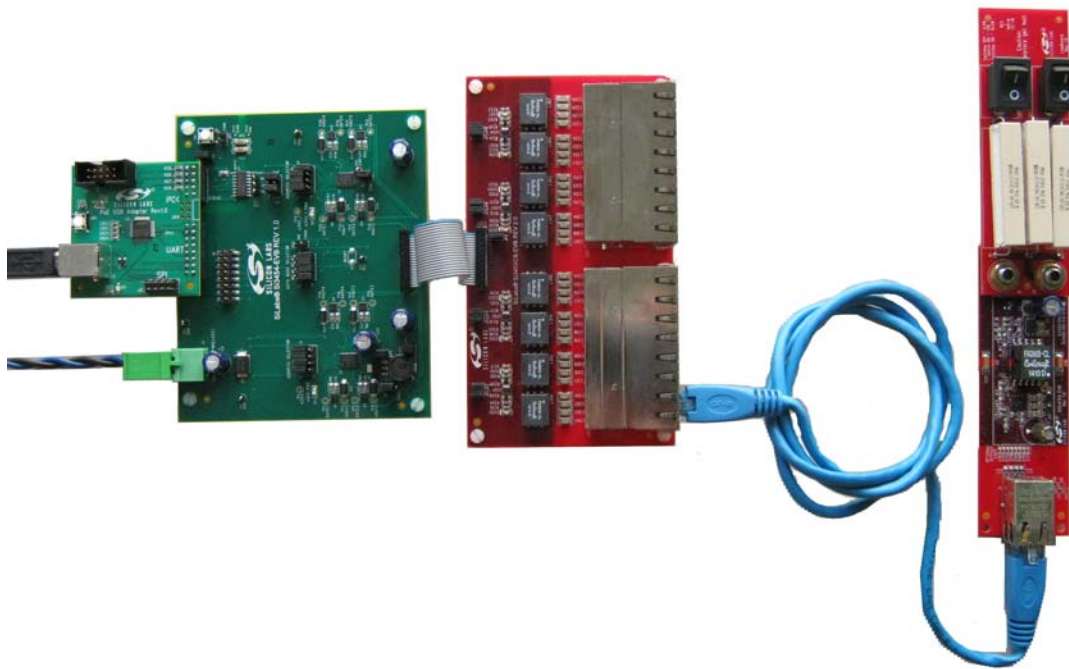

**Figure 5. Evaluation Kit Hardware**

Reference Figure 5 for overall system connection. Perform initial setup as follows:

1. Verify that Evaluation Board jumper placements are correct, according to Figure 18 schematic, Figure 6. “Physical Jumper Placement” and Table 2. On the Connector Board, the default condition occurs when all jumpers are installed.
2. Connect the Si3454 evaluation card (Si3454-EVB) to the RJ45 (Si3459CB-EVB) card using the 20-pin ribbon cable.
3. Plug J104 (refer to the silkscreen on the bottom of the board) of the PoEUSB adapter into J2 of the Si3454-EVB.
4. Connect a 52 V power supply to J3. When the high voltage supply is turned on, the power LED D3 will indicate that the on-board generated 3.3 V logic supply is active. The power LED location is indicated by green circles in Figure 6. “Physical Jumper Placement”.
5. Plug the PoEUSB adapter into an available computer USB port if this was not already done during the software installation step. If the drivers were installed properly, the PC should recognize the adapter.
6. The Si3454 Evaluation Board is configured as a midspan power injector. The data input lines are on the top row, and the power plus data output lines are on the bottom row. See Figure 7. A Powered Device (PD) is plugged into the bottom row.
7. Start the Si3454 & Si3459 Monitor.

# Si3454-KIT

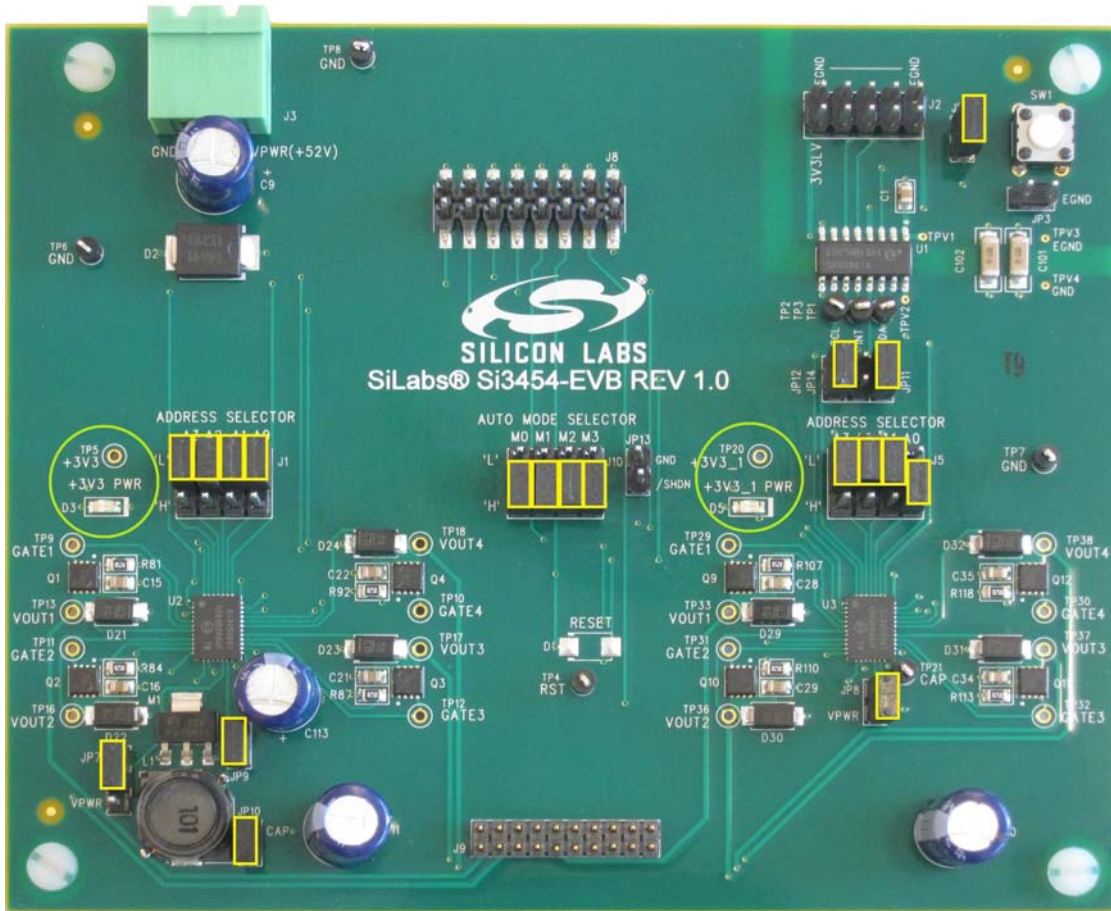

Figure 6. Physical Jumper Placement

Table 2. Si3454-EVB Jumper Table

Jumper	Function	Initial Setting
J1	Si3454 U12 address	L,L,L,L
J5	Si3454 U11 address	L,L,L,H
J10	Auto mode selection	H,H,H,H
JP3	Assert reset from host voltage domain	OFF
JP6	Debounce reset from SW1	ON
JP7	Enable buck converter	ON (1,2)
JP8	Disable buck converter	ON
JP9	Isolate buck components when chained	ON
JP10	Isolate buck components when chained	ON
JP11	Remove pullup for chained operation	ON
JP12	Remove pullup for chained operation	ON

**Table 2. Si3454-EVB Jumper Table (Continued)**

Jumper	Function	Initial Setting
JP13	Force shutdown	OFF
JP14	Breaker for isolated Reset line. Remove when chained and/or PoEUSB is not connected.	OFF

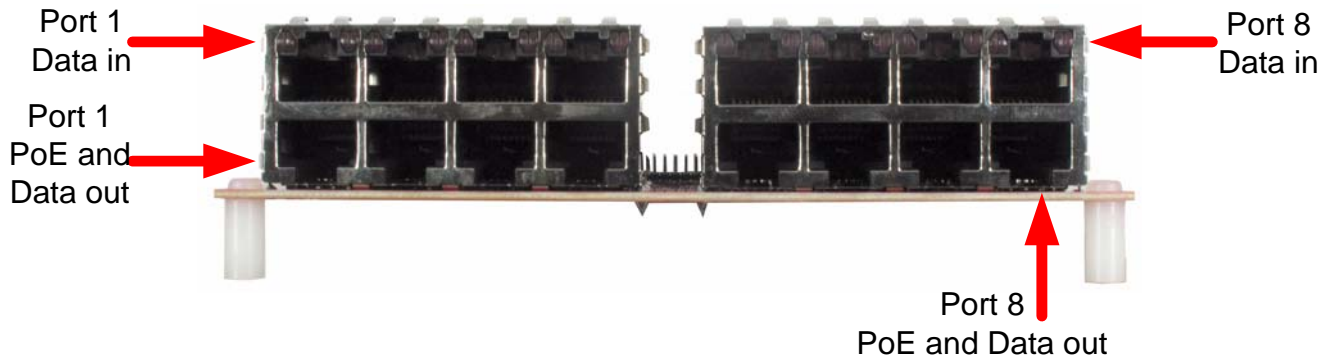

**Figure 7. Connector Board Configuration**

EVB board connector J8 supports chaining multiple Si3454 boards together to demonstrate and test configurations with larger numbers of Si3454 devices. Chaining is done with a standard 0.1 inch spacing ribbon cable. Using jumpers, switching supplies on chained boards should be disabled. Redundant I<sup>2</sup>C pullups may be disabled as well. Consult with Silicon Labs applications engineering for further details.

# Si3454-KIT

## 5. Using the Si3454 & Si3459 Monitor

To run the Si3454 & Si3459 Monitor, double click on the “Si3454 & Si3459 Monitor” desktop icon. You may also run the Si3454 & Si3459 Monitor from the Start menu, by selecting: **Start**→**All Programs**→**Silicon Laboratories**→**Si3454 & Si3459 Monitor**. Figure 8 shows the Si3454 & Si3459 GUI when it is initially opened. The version of the Si3454 & Si3459 Monitor is displayed at the bottom of the window.

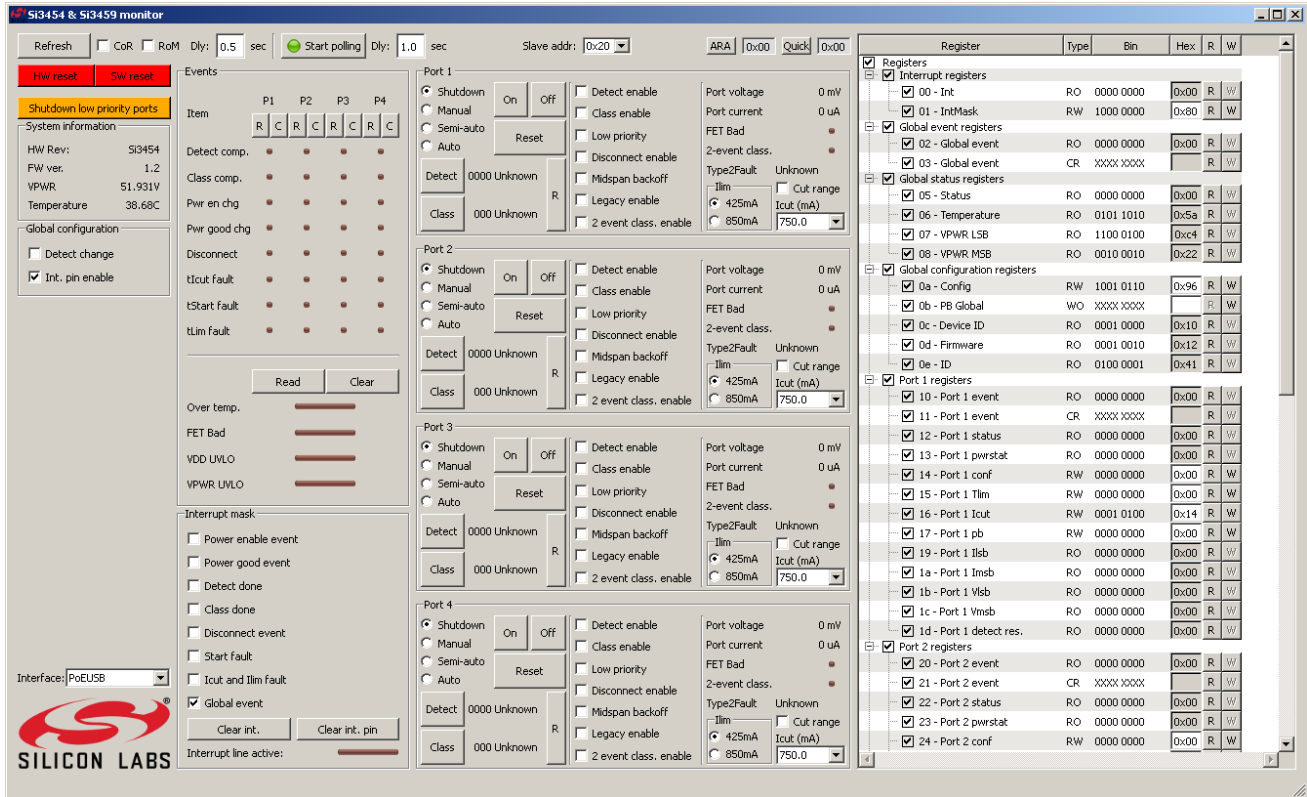

Figure 8. Si3454 & Si3459 Monitor GUI

### 5.1. Interface Selector

Ensure that the Interface Selector in the lower left of the monitor window indicates “Interface: PoEUSB”. If it shows “Interface: Dummy”, you have not successfully installed and connected to the PoE USB interface adapter.



Figure 9. Interface Selector

The Interface Selector specifies which USB-to-I<sup>2</sup>C converter device to use for communicating with the Si3454 PSE controllers. The Si3454 & Si3459 Monitor supports several different USB-to-I<sup>2</sup>C converter devices. If more than one of these devices is connected to the PC at the same time, then the user can select which one to use with the Interface drop-down box.

The “Dummy” device is a substitute device that does not actually perform I<sup>2</sup>C communications. The Dummy device allows the Si3454 & Si3459 Monitor to be opened and perform in an emulation mode even if there are no USB-to-I<sup>2</sup>C converter devices connected to the PC.



## 5.2. Si3454 & Si3459 Monitor Layout

Along the top are monitor controls. On the left side are Si3454 global identification, power information and settings. Immediately to the right are events and interrupts. On the right side all the Si3454 registers are individually accessible. The middle section provides a graphical interface to the Si3454 registers. Changes made in either the register or graphical view are instantly updated in the other view.

## 5.3. Monitor Control

The primary purpose of the Monitor Control area is to configure and control the operation of the GUI itself.

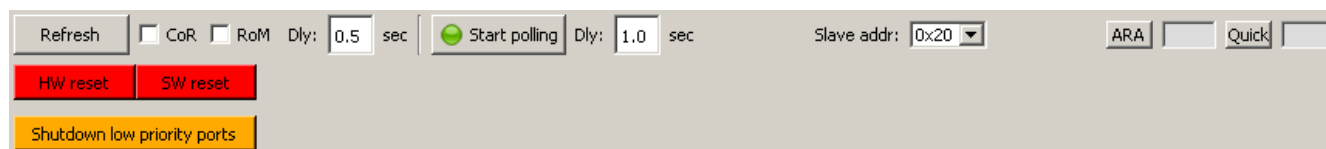

**Figure 10. Monitor Control Area**

The user may manually update the GUI by clicking the “Refresh” button. The GUI reads the Si3454 registers and updates the displayed information.

The user may cause the GUI to automatically update itself at regular intervals by clicking on the “Start polling” button. Once pressed, the button text changes to “Stop polling”. The green LED symbol on the Polling button flashes red each time an update occurs. The “Poll delay” text box allows the user to specify the time between updates. The user may stop automatic updates by clicking on the “Stop polling” button.

The user selects which Si3454 controller to use with the “Slave addr” box. Several Si3454 controllers may be connected to the I<sup>2</sup>C bus. The “Slave addr” box specifies which of the Si3454 controllers to communicate with. The GUI transacts with only one Si3454 at a time. The user may dynamically switch the GUI between different Si3454s by selecting a new address in the “Slave addr” box corresponding to the jumper setting on the Si3454-EVB (J1, J5).

If the user checks the “CoR” (Clear on Read) check box, then the GUI also reads the Si3454’s CoR registers when updating. If the CoR check box is not checked, then the GUI does not read the CoR registers when updating. The CoR registers are the Global and the Port Event registers. Reading a CoR register has side effects: It clears that register and clears the associated event bit in the interrupt register. Consequently, if the CoR check box is checked while the GUI is polling, then events could come and go without being noticed by the user.

If the user checks the “RoM” (Read on Modify) check box, then the GUI automatically updates itself after the user modifies a register via the GUI. The GUI automatically shows the effect of any change within a time delay, specified by the “RoM delay” text box. The RoM behavior is only useful if polling is stopped.

The Monitor Control area has three buttons. The “SW Reset” button resets the Si3454 by setting the “swrst” bit in the pb\_global register. The “Shutdown low priority ports” button turns off all low priority ports by setting the “lowpri” bit in the pb\_global register. The “HW Reset” button causes a reset pulse to be asserted on the Si3454 Reset pin. This fully resets all Si3454 devices on the board.

## 5.4. Device Information

The Device Information box displays high-level information about the Si3454 device, including hardware revision and the firmware version.

**Note:** The example shown in Figure 11 is representative but may not contain the same data as that displayed with your board.

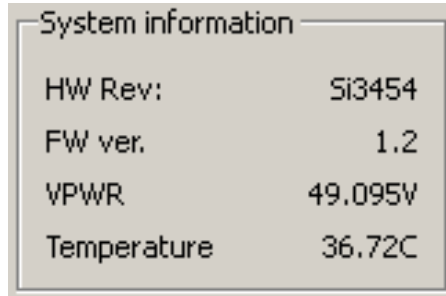

Figure 11. Device Information Box

## 5.5. Port Boxes

The port boxes display port status and have controls for configuring and controlling the ports. Each port has its own box.

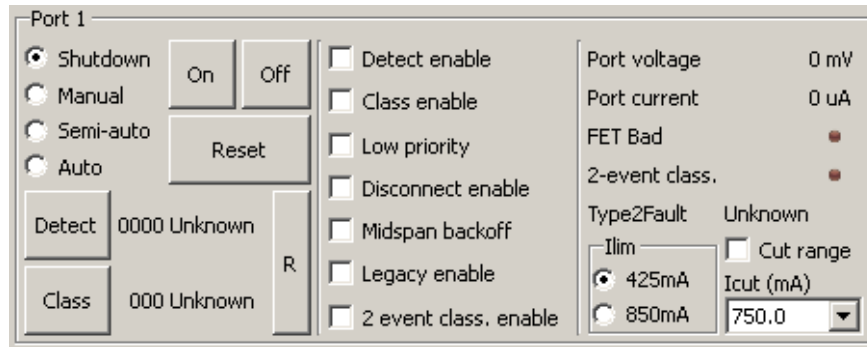

Figure 12. Port Box

### 5.5.1. Port Status

A port box displays the results of the last detection and last classification in the lower left. If not polling, the user may manually update the port detect and classify status by clicking on the “R” (read) button.

Port voltage and current are displayed in the port box upper right corner. If polling is not enabled, then the user may manually update the port voltage and current reading by clicking on the “Refresh” button.

### 5.5.2. Port Configuration

A port box contains four radio buttons to configure the mode of the port. The port mode may be Shutdown, Manual, Semi-auto, or Auto.

The port features can be configured with the four checkboxes on the right pane. If “Disconnect enable” is checked, the port removes power if the powered device is unplugged. If the “2 event class. enable” is checked, then the Si3454 will follow the IEEE802.3at Type 2 (2-event) classification method for PDs presenting Class 4 signature during the first event. The “2-event class” LED is lit when the Type 2 classification is successful.

The “Type2Fault” provides additional status information about the classification. The “FET Bad” LED is lit when the external FET is damaged.

The following steps detail how a port can be manually turned on in the IEEE 802.3at Type 2 high-power manner (see Figure 16 on page 16):

1. Enable detection and classification by checking the “Detect enable” and “Class enable” check-boxes.

2. Enable the 2 event classification by checking the "2 event class. enable" check box.
3. Watch for a successful 2 event classification by checking the state of the "2-event class." LED
4. Once the classification is successful, set the Ilim to 850 mA
5. Set the proper Icut limit (see below) according to the available power
6. Turn on the port using the "On" pushbutton.

If "Low priority" is checked, the port immediately removes power if the "Shutdown low priority ports" button is clicked. If "Legacy enable" is checked, then the port supplies power to a legacy powered device even though the powered device does not provide a valid detection resistance. The "Legacy enable" check box supports compatibility with certain older PD devices. Please consult the Si3454 data sheet for details. Checking "Midspan backoff" allows selection of midspan type Alternative B detection back-off timing.

The user may configure a port's Icut level with the "Icut (mA)" drop-down box. The port automatically removes power if the port current is greater than the Icut level for more than 60 ms.

### 5.5.3. Port Control

A port box contains three buttons for controlling a port. The "On" button forces a port to supply power; the "Off" button forces a port to remove power, and the "Reset" button resets a port. Detect and Class buttons force a single detection or classification operation.

## 5.6. Interrupts and Events

The Si3454 detects multiple events based on state of the device in general and its ports. Events may be configured to generate interrupts. The GUI displays events, allows individual interrupts to be enabled and disabled, and displays the status of interrupts.

### 5.6.1. Interrupt Enable

The Interrupt Enable box shown in Figure 13 specifies which events cause the Si3454 to generate an interrupt.

If the interrupt line is active, the Interrupt Line Active bar at the bottom of the Interrupts box is bright red instead of dark red. Note that if there are multiple Si3454 controllers in the system, one or more of these controllers may be pulling the interrupt line low. It may not be the currently-selected Si3454 that is making the interrupt line active.

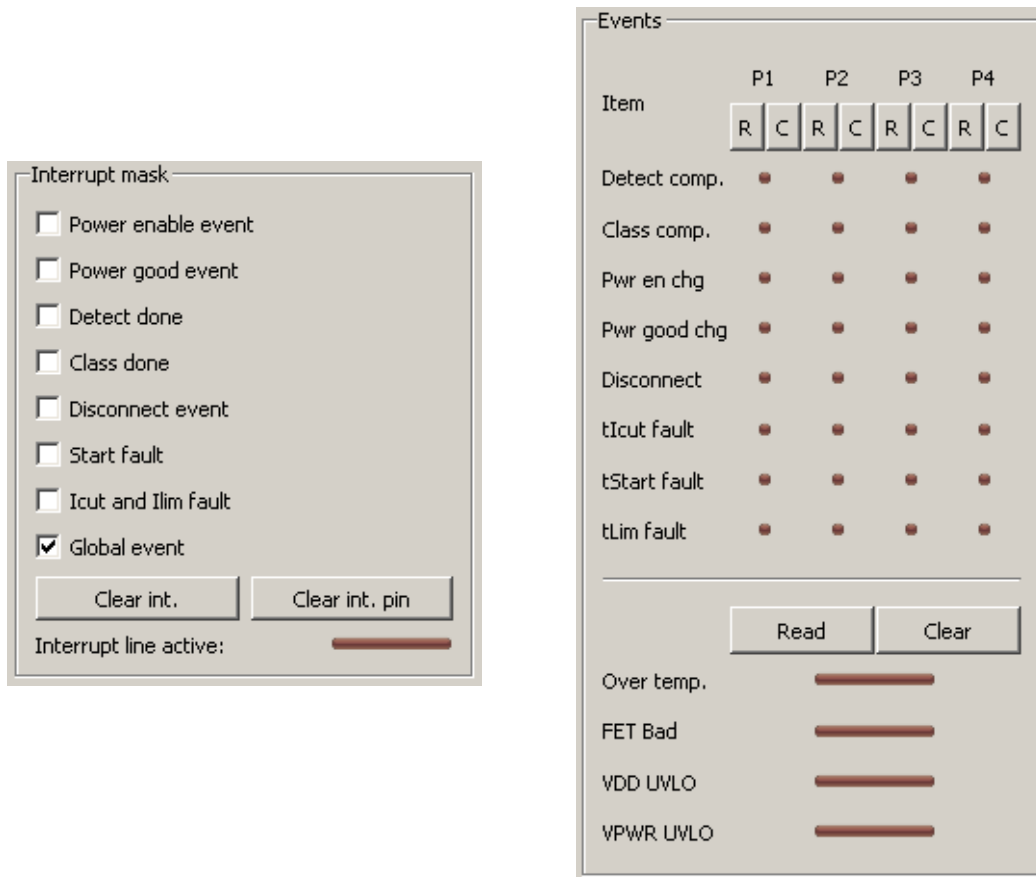

**Figure 13. Interrupt Enable and Events Boxes**

## 5.6.2. Events

The Events box shown in Figure 13 displays the status of the interrupt line and the port events. The GUI events section indicates both global and port-specific events. Each events register consists of a pair of read-only (RO), and clear-on-read (CoR) registers with the same event bits. Reading the RO register obtains the bit values but does not affect the bits. Reading the CoR register obtains the values of the bits, and also clears the bits in both the RO and CoR registers. The indicators in the GUI Events section show the values from the RO register if the RO register is read by push of the “R” button or by polling.

Events enabled to cause an interrupt will propagate to the interrupt active indicator, but will only be reflected in the remainder of the GUI when the RO registers are read. For the best real-time view of the Si3454 events bits, it is recommended to enable polling.

## 5.7. Register List

The Register List shown in Figure 14 displays the contents of the Si3454 registers and allows the user to change the register contents.

Register	Type	Bin	Hex	R	W
<input checked="" type="checkbox"/> Registers					
<input checked="" type="checkbox"/> Interrupt registers					
<input checked="" type="checkbox"/> 00 - Int	RO	0000 0000	0x00	R	W
<input checked="" type="checkbox"/> 01 - IntMask	RW	1000 0000	0x80	R	W
<input checked="" type="checkbox"/> Global event registers					
<input checked="" type="checkbox"/> 02 - Global event	RO	0000 0000	0x00	R	W
<input checked="" type="checkbox"/> 03 - Global event	CR	XXXX XXXX		R	W
<input checked="" type="checkbox"/> Global status registers					
<input checked="" type="checkbox"/> 05 - Status	RO	0000 0000	0x00	R	W
<input checked="" type="checkbox"/> 06 - Temperature	RO	0101 0111	0x57	R	W
<input checked="" type="checkbox"/> 07 - VPWR LSB	RO	1110 0110	0xe6	R	W
<input checked="" type="checkbox"/> 08 - VPWR MSB	RO	0010 0000	0x20	R	W
<input checked="" type="checkbox"/> Global configuration registers					
<input checked="" type="checkbox"/> 0a - Config	RW	1001 0110	0x96	R	W
<input checked="" type="checkbox"/> 0b - PB Global	WO	XXXX XXXX		R	W
<input checked="" type="checkbox"/> 0c - Device ID	RO	0001 0000	0x10	R	W
<input checked="" type="checkbox"/> 0d - Firmware	RO	0001 0010	0x12	R	W
<input checked="" type="checkbox"/> 0e - ID	RO	0100 0001	0x41	R	W
<input checked="" type="checkbox"/> Port 1 registers					
<input checked="" type="checkbox"/> 10 - Port 1 event	RO	0000 0000	0x00	R	W
<input checked="" type="checkbox"/> 11 - Port 1 event	CR	XXXX XXXX		R	W
<input checked="" type="checkbox"/> 12 - Port 1 status	RO	0000 0000	0x00	R	W
<input checked="" type="checkbox"/> 13 - Port 1 pwrstat	RO	0000 0000	0x00	R	W
<input checked="" type="checkbox"/> 14 - Port 1 conf	RW	0000 0000	0x00	R	W
<input checked="" type="checkbox"/> 15 - Port 1 Tlim	RW	0000 0000	0x00	R	W
<input checked="" type="checkbox"/> 16 - Port 1 Icut	RW	0001 0100	0x14	R	W
<input checked="" type="checkbox"/> 17 - Port 1 pb	RW	0000 0000	0x00	R	W
<input checked="" type="checkbox"/> 19 - Port 1 Ilsb	RO	0000 0000	0x00	R	W
<input checked="" type="checkbox"/> 1a - Port 1 Imsb	RO	0000 0000	0x00	R	W
<input checked="" type="checkbox"/> 1b - Port 1 Vlsb	RO	0000 0000	0x00	R	W
<input checked="" type="checkbox"/> 1c - Port 1 Vmsb	RO	0000 0000	0x00	R	W
<input checked="" type="checkbox"/> 1d - Port 1 detect res.	RO	0000 0000	0x00	R	W
<input checked="" type="checkbox"/> Port 2 registers					
<input checked="" type="checkbox"/> 20 - Port 2 event	RO	0000 0000	0x00	R	W
<input checked="" type="checkbox"/> 21 - Port 2 event	CR	XXXX XXXX		R	W
<input checked="" type="checkbox"/> 22 - Port 2 status	RO	0000 0000	0x00	R	W
<input checked="" type="checkbox"/> 23 - Port 2 pwrstat	RO	0000 0000	0x00	R	W
<input checked="" type="checkbox"/> 24 - Port 2 conf	RW	0000 0000	0x00	R	W

**Figure 14. Register List**

The Register List displays all of the Si3454's registers grouped by category. Each category of registers can be expanded and collapsed by clicking on the plus and minus signs at the left edge of the Register List.

Next to the register name, the type of each register is displayed. Each register is either RW (read/write), RO (read only), WO (write only) or CR (Clear on Read). WO registers reflect the value applied by the user.

# Si3454-KIT

---

The user may specify which registers to read (when the GUI is updated) by checking a box at the left of each register name. Refreshing, polling, and RoM, all depend on these settings. Clear on Read registers are read only if both the CoR check box is checked and the check box for the individual CR register is checked.

The user may read and write individual registers by using the “R” (read) and “W” (write) buttons at the right edge of each register. The “R” and “W” buttons are disabled if the operation is not allowed for the type of register. The display of the whole register file can be read and updated at once by clicking on the “Refresh” button.

The Register List displays the value of each register in binary and hexadecimal form. If a register has not yet been read, then its binary value is displayed as all Xs, and its hexadecimal value is blank.

A register's hexadecimal value is displayed in a text box. If a register is not writable (RO or CR), then its text box is gray and its hexadecimal value cannot be changed by the user. If a register is writable (RW), then its text box is white and its hexadecimal value can be changed by the user. After changing a register's value, the user clicks on the register's “W” button to write the new value to the register.

## 6. Operating the System

Each RJ45 connector board has eight LEDs for the eight ports. Each LED is driven by a comparator circuit which detects when a voltage is forced to the load at the PoE output. When the ports are in auto mode, the LEDs in the RJ45 connector board flash, indicating the detection cycle until a valid PD is connected. Once a valid PD is connected and the port is turned on, the LEDs will glow steadily until the PD is disconnected. Once the PD is connected, the port current will be displayed on the GUI. Note that the comparator circuits load the ports slightly, and the LEDs dissipate power from the 3.3 V rail. If performing calibrated tests, it may be desirable to isolate the comparator circuitry and eliminate any loading. This may be done by removing all jumpers from the connector board.

The easiest way to get started is to put all of the ports in Auto mode. In Auto mode, detection, classification, power management based on classification (Icut setting), disconnect (when enabled by “Disconnect Enable”), fault protection, fault recovery, and port monitoring all happen without user intervention. Figure 15 shows the result of putting Port 1 in Auto mode. Circles indicate the required settings, and the squares indicate that a PD connected to the port has been detected, classified, and powered. Auto mode may also be enabled on all ports by configuring J10 and resetting the board by pressing SW1 or cycling power.

The Si3454 normally operates in manual or semi-automatic mode with the AUTO pin is held low. If a positive voltage is applied to the AUTO pin, the Si3454 enters into fully autonomous operation, independent of a host. The Si3454 also features dc disconnect detection algorithms to determine when a PD device is disconnected from any of the eight independent ports. The AUTO mode can be set via the AUTO pin or from the host via I<sup>2</sup>C. At power-up, the Si3454 reads the voltage on the AUTO pin (which can be set by a resistor divider from VDD to GND). If a positive voltage is applied, the Si3454 enters into AUTO mode (all ports operate fully autonomously). The AUTO pin voltage level configures the Si3454’s behavior to register default values. For additional detail on Auto Pin Configurations, refer to Section 3.2 Operating Modes in the Si3454 data sheet.

If the GUI is left in polling mode, the port status, port current, port voltage are all automatically updated by polling the appropriate registers of the Si3454.

The Si3454 itself normally powers up as Alternative A, with no detection back-off, meaning the detect function cycles at its highest rate. This is the most common usage for the Si3454. The RJ-45 connector board for the evaluation kit is configured to inject the power on the “spare pairs” of the Ethernet cable, which is the Alternative B or “Midspan” connection. Detection back-off is intended to ensure that a midspan and an endpoint do not compete with each other and result in a failure to provide power. With detection back-off, the time between detection pulses is increased to just over two seconds so as not to compete with the normal (approximately three times per second) detection of an endpoint. If detection back-off is required, click the “Midspan” button to toggle this mode. You will see that the LEDs on the connector board now flash at the slower detection speed. To toggle the mode back to standard detection timing, click the button again.

The Si3454 in auto mode is fully-compliant with the 802.3at standard (often called PoE+), which allows up to 30 W to be delivered over the Ethernet cable. In host-controlled mode, to enable the higher power support for a given port, it is necessary to make multiple selections as described in "5.5.2. Port Configuration" on page 10. When Auto mode is selected by the Auto jumper, the Si3454 automatically performs the two-event classification and increases the cut-off current if a Class 4 PD is detected. The Si3402 evaluation board provided with the kit is configured to provide the Class 4 signature; so, if the PoE+ mode is enabled and the Si3402 is plugged in, the cut-off current is automatically set to 643.2 mA. Figure 16 shows the result of plugging in a Class 4 PD (into Port1) with PoE+ power enabled. Class 4-specific settings and results are highlighted.

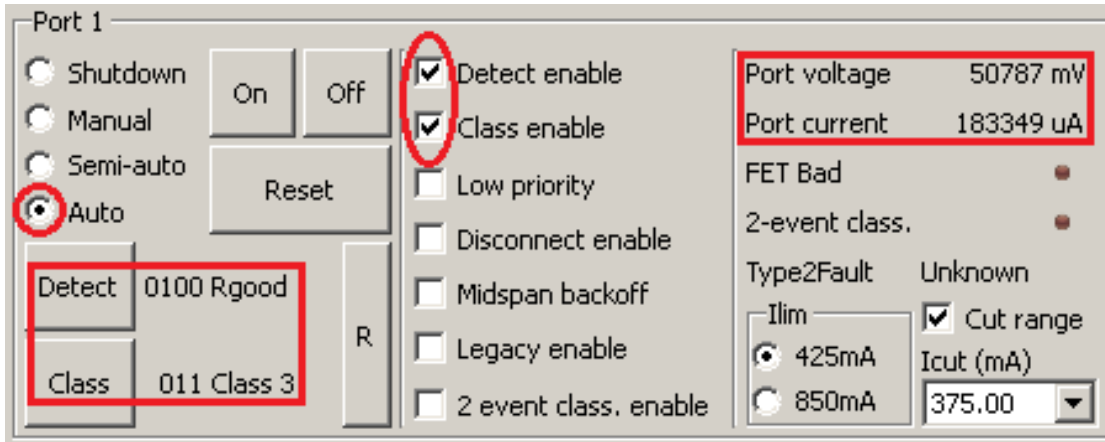

Figure 15. Example Result of Device Connection in Port Auto Mode

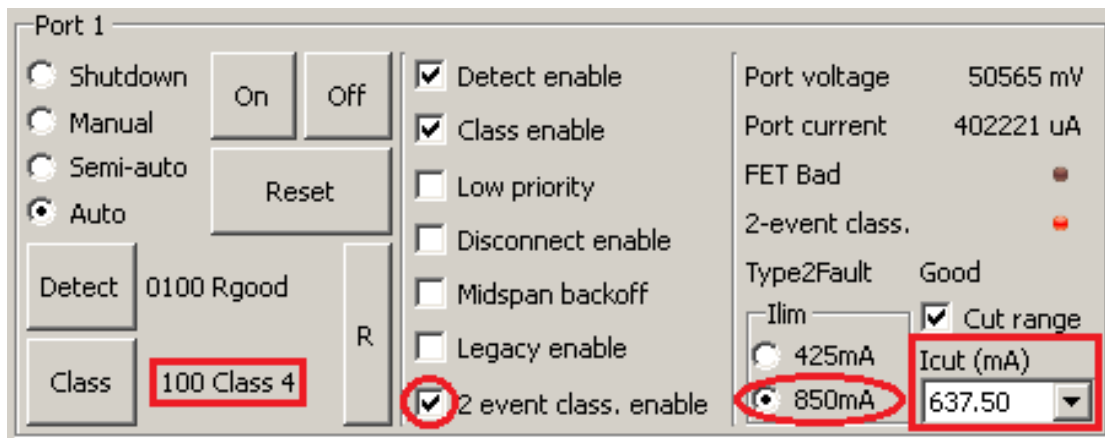

Figure 16. Class 4 Connection



## 7. Board Schematics, BOM, and Layout

The following are general PCB layout considerations. Detailed schematics, BOM, and layout can also be found in the following sections. Visit the Silicon Labs Technical Support web page and register to submit a technical support request, particularly if you are not closely following the recommended reference design.

### 7.1. Design and Layout Considerations

The Si3454 directly drives and senses detection and classification stimulus voltages. PoE power is enabled through external FETs. PoE power supply currents in each channel are sensed using current shunt resistors with sensed voltage referenced to GND.

Normally the layout will be 4-layer, with dedicated VPWR and GND planes for PoE power delivery. The ground power plane does not generally have a high frequency content; so, it is acceptable to use a single GND plane and tie GND, AGND, DGND pins to it. The thermal pad of the Si3454 is connected to GND. Si3454 internal dissipation is modest, but for best performance the layout should include a thermal bond consisting of multiple vias between the thermal pad and GND. The PoE power MOSFETs carry up to 800 mA dc and up to 5 A in faults; so, a 20 mil trace with wide or multiple vias is also recommended.

The Si3454 includes a buck type dc-dc converter controller function, which generates a raw ~4 V power rail VCAP. The buck regulator is able to supply 200 mA; so, within a group of Si3454 devices, only one buck regulator is required. The single buck regulator supplies low drop-out (LDO) regulators within individual Si3454 devices to generate their VDD = 3.3 V. Each LDO supplies the 3.3 V requirements of its own Si3454. The Si3454 VDD LDO is able to supply additional current for an external device, such as an isolator or low-power-management microcontroller.

The Si3454 buck regulator is a potential EMI source. The power devices, e.g. switching MOSFET, inductor, diode and output capacitor should be located as close together as possible to minimize loop area. The entire switching circuit should be shielded from Si3454 port connections to minimize the chance of interference.

To improve sensing accuracy, the Si3454 provides Kelvin connections for the resistor low side sense. The SENSEx signals are connected to GND potential, but for best performance they should be routed separately from the GND plane.

To avoid coupling between surge events and logic signals, it is recommended that VOUTn traces be well separated from I<sup>2</sup>C interface pins.

A typical layer stackup is as follows:

1. Top: I<sup>2</sup>C, Si3454 Kelvin current sense
2. VPWR, VDD = 3.3 V
3. VEE = GND
4. Bottom: VOUT, switcher, VCAP

The I<sup>2</sup>C bus runs at 400 kHz maximum. The I<sup>2</sup>C bus lines should be routed away from analog lines like Rbias or Vref but can otherwise be routed with ordinary care. If using a Silicon Labs I<sup>2</sup>C isolation product, please observe the connections as per the reference design, which take into account required voltage margins and pullup values.

## 7.2. Si3454 Schematics

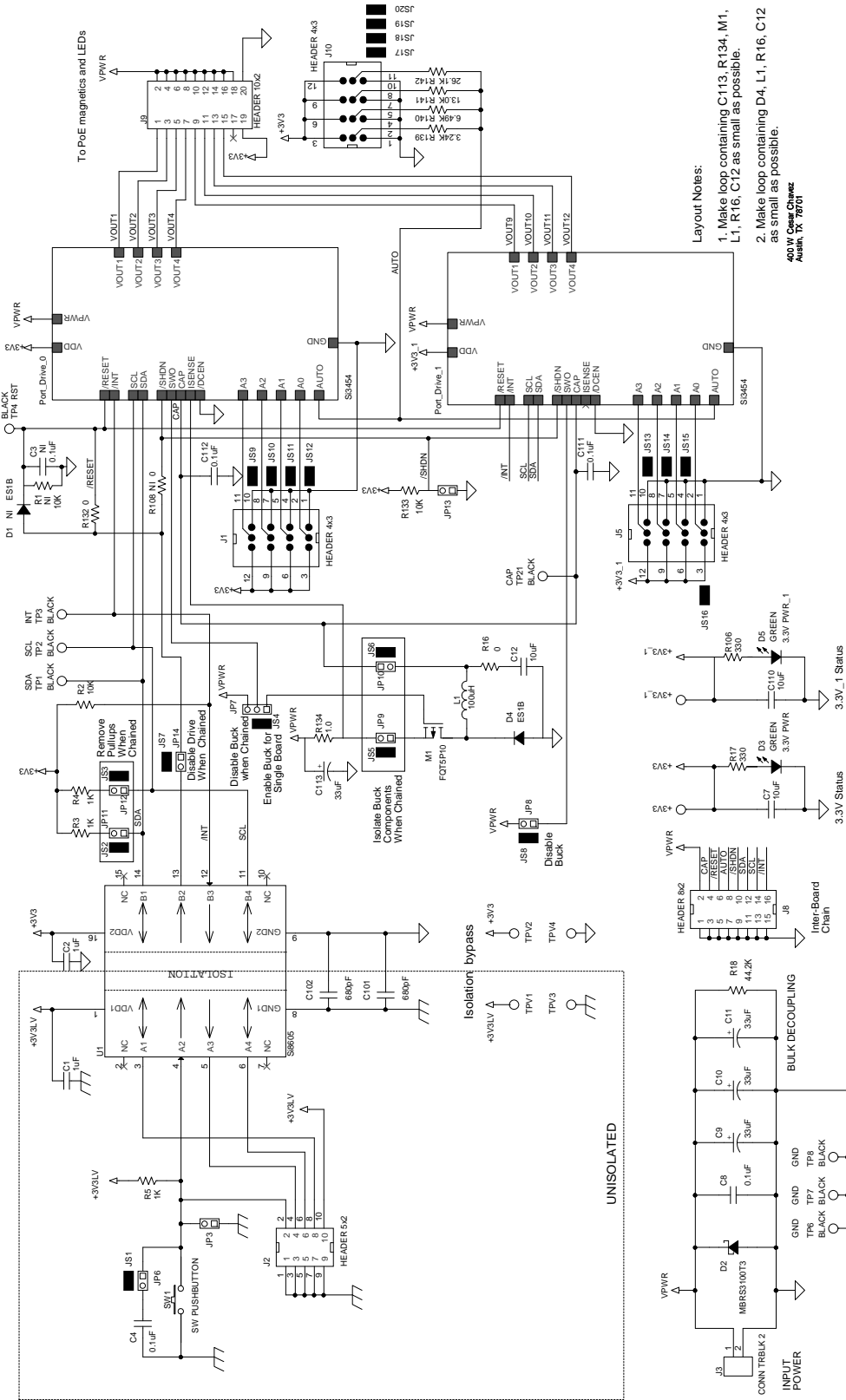

Figure 17. Evaluation Board Top Level

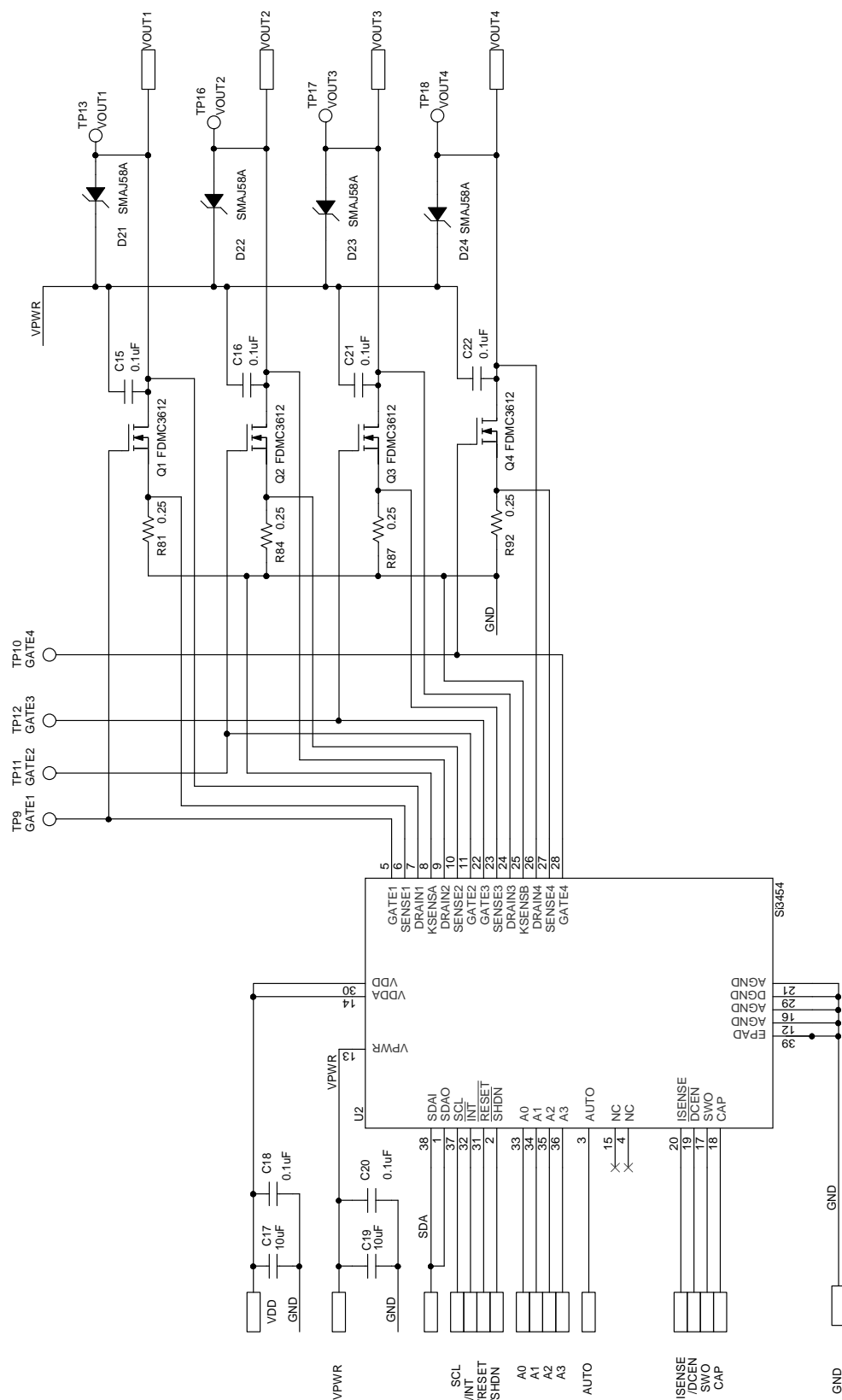

Figure 18. Si3454 Controllers (1 of 2)



## 7.3. Si3454 Evaluation Board Layout

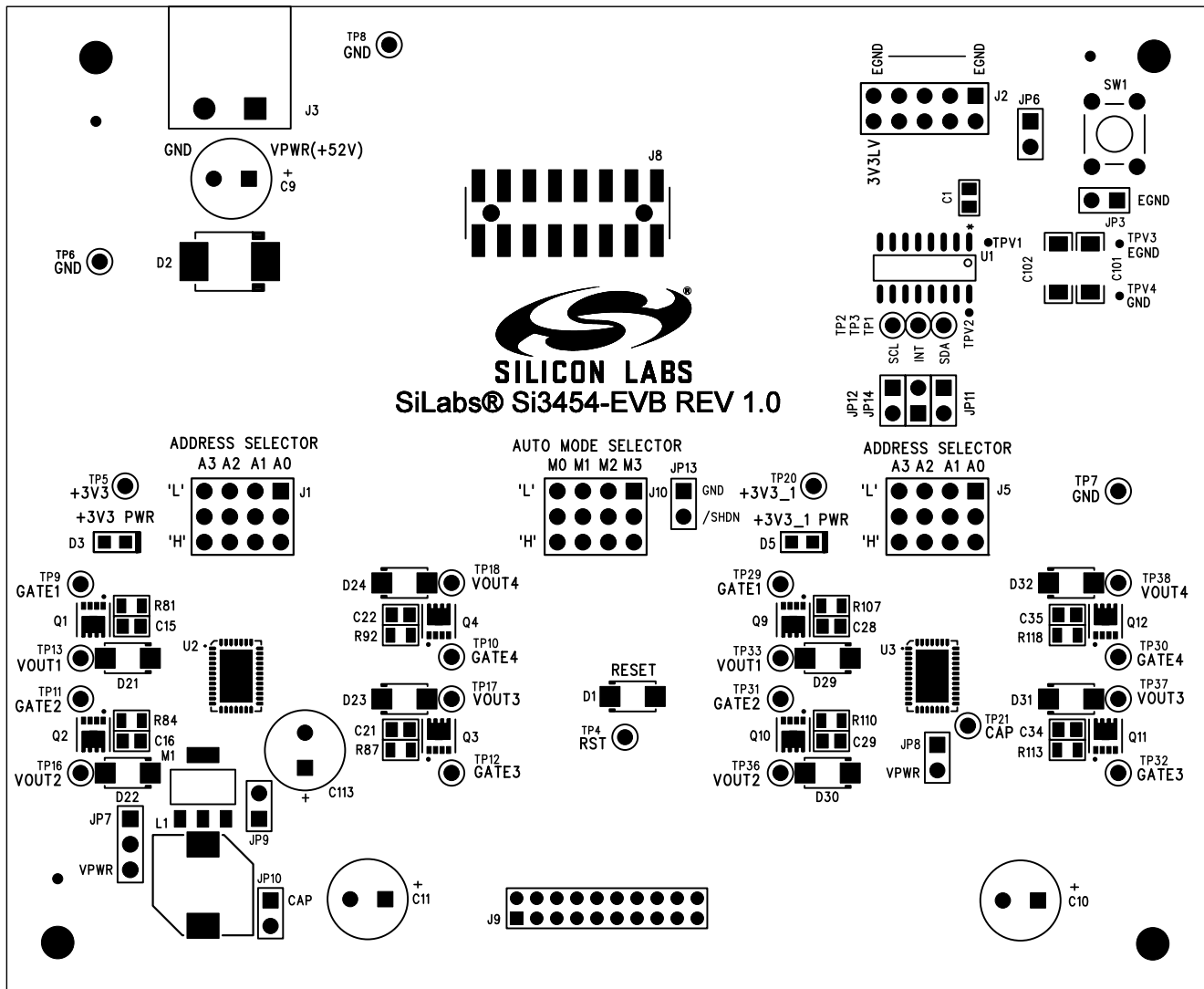

Figure 20. Evaluation Board Top Silkscreen

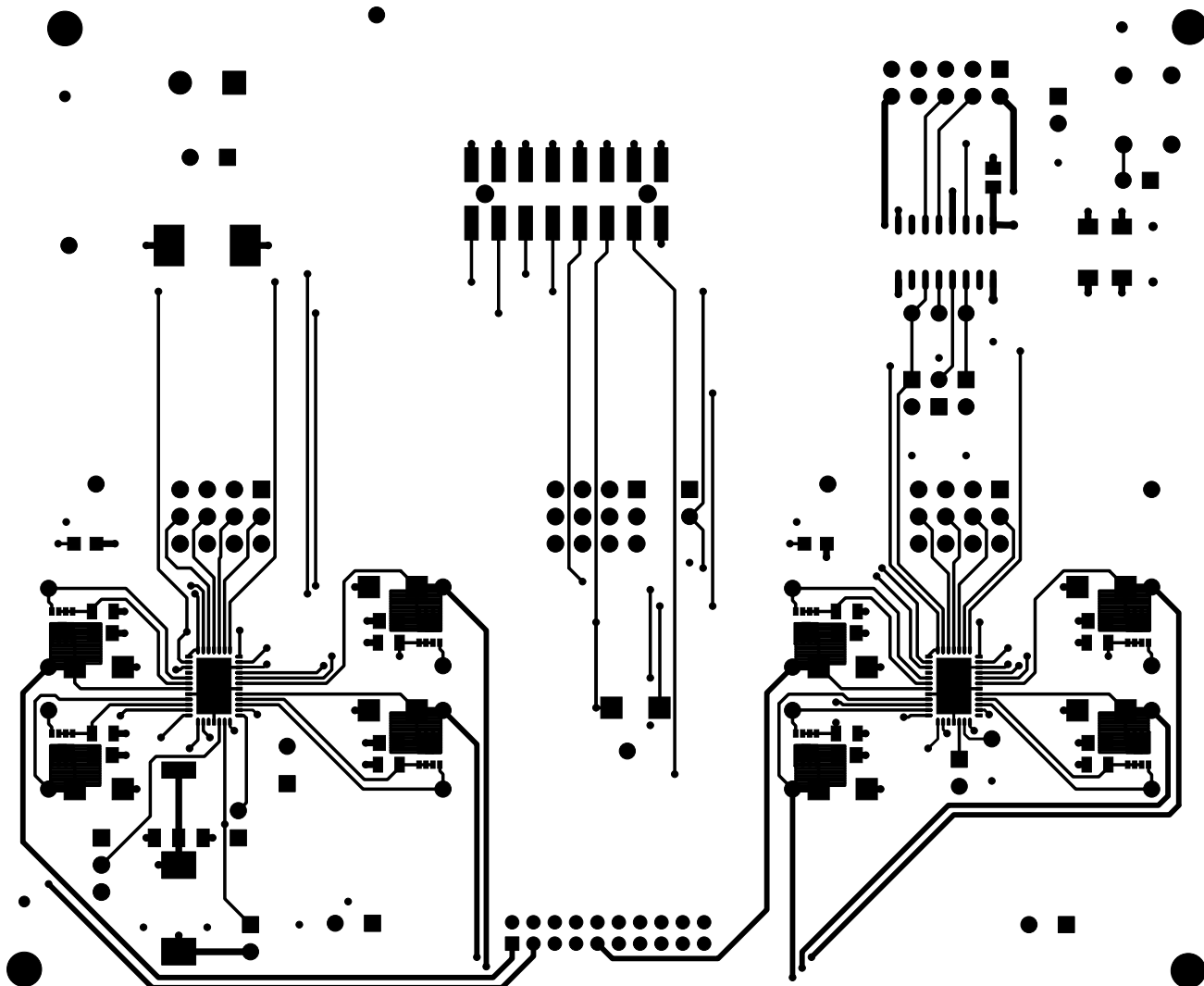

Figure 21. Evaluation Board Top Side

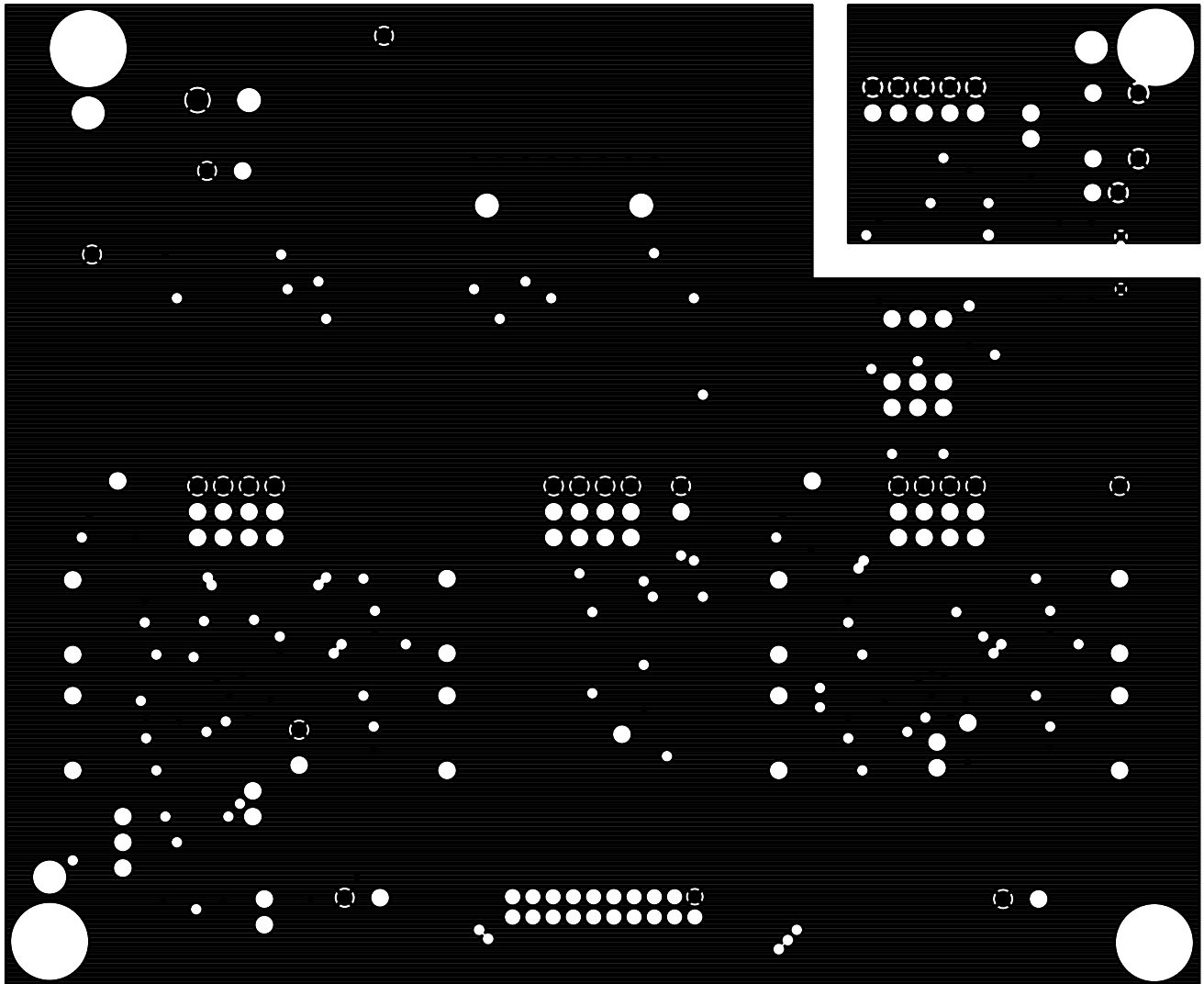

Figure 22. Evaluation Board Ground Layer

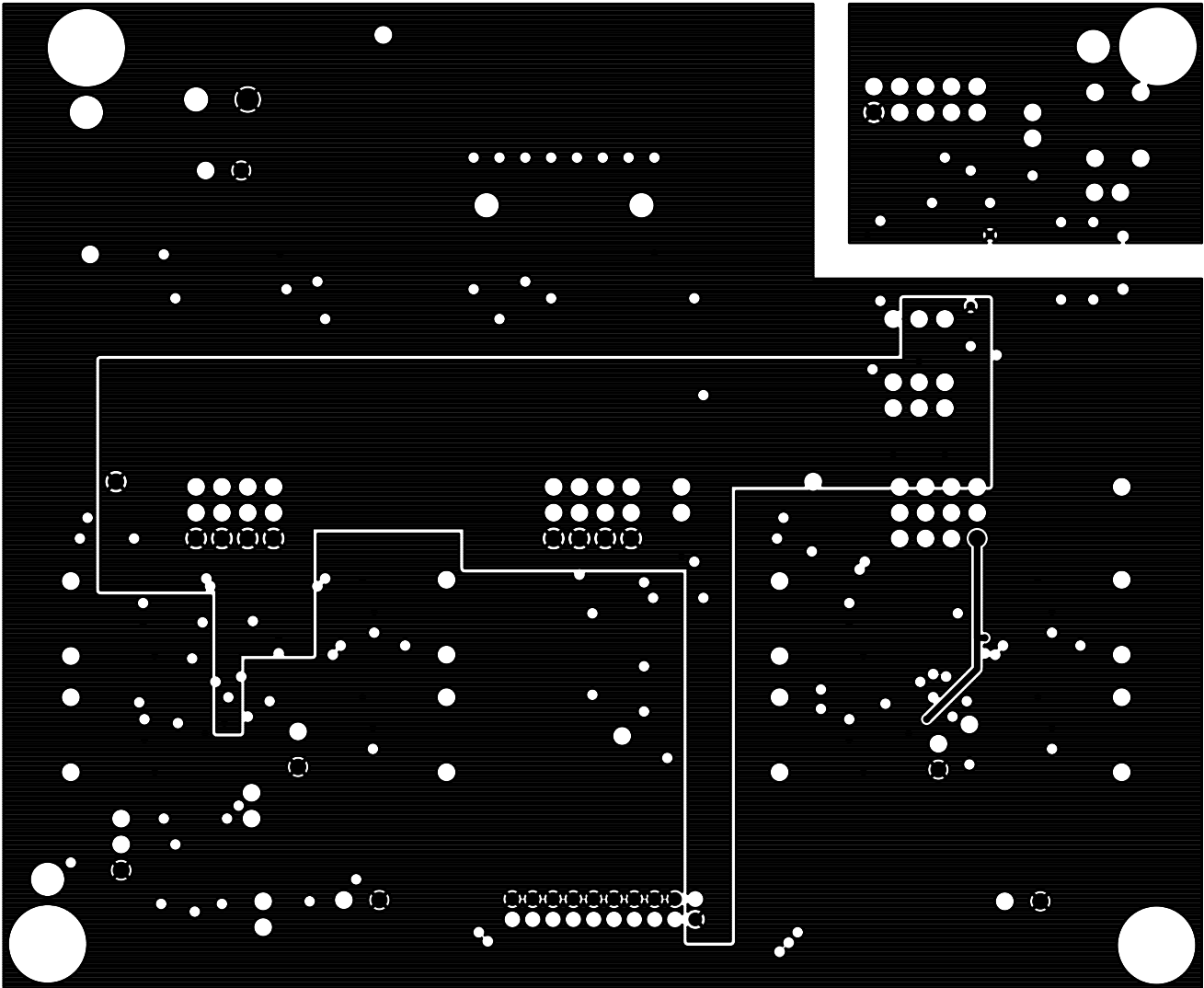

Figure 23. Evaluation Board Power Layer



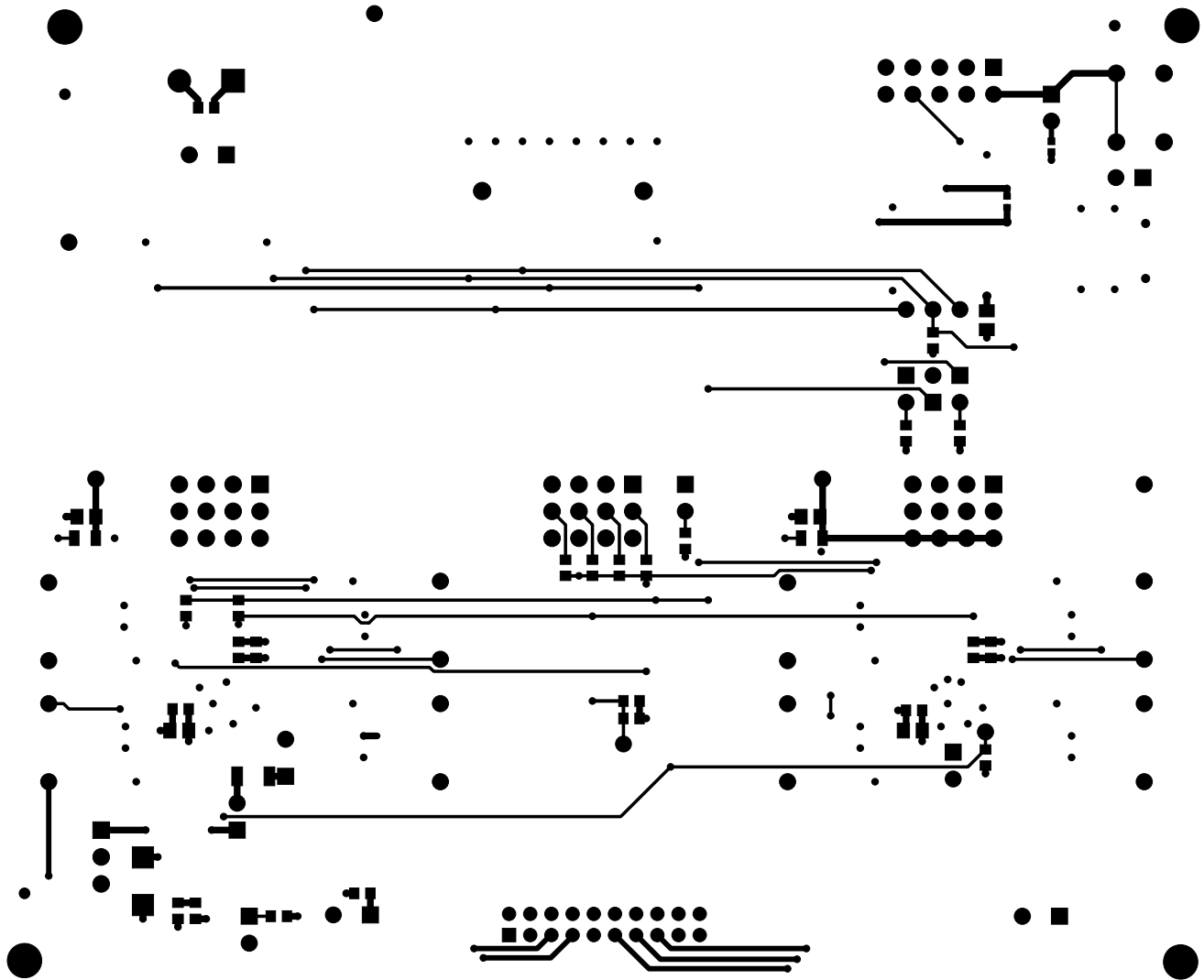

Figure 24. Evaluation Board Bottom Side

# Si3454-KIT

## 7.4. Si3454 Bill of Materials

**Table 3. Si3454 Evaluation Board Bill of Materials**

Qty	Ref	Value	Rating	Voltage/C urrent	Tol	Type	PCB Footprint	Mfr Part Number	Mfr
2	C1,C2	1uF		16V	±20%	X7R	C0805	C0805X7 R160-105 M	Venkel
4	C3,C8, C111, C112	0.1uF		100V	±20%	X7R	C0603	C0603X7 R101-104 M	Venkel
1	C4	0.1uF		10V	±10%	X7R	C0402	C0402X7 R100-104 K	Venkel
2	C7,C110	10uF		10V	±20%	X5R	C0805	C0805X5 R100-106 M	Venkel
4	C9,C10, C11,C113	33uF		100V	±20%	Alum_Ele c	C3.5X8M M-RAD	ECA2AM 330	Panasonic
5	C12,C17,C19,C 30,C32	10uF		10V	±10%	X5R	C0603	C0603X5 R100-106 K	Venkel
10	C15,C16,C20,C 21,C22,C28,C2 9,C33,C34,C35	0.1uF		100V	±10%	X7R	C0805	C0805X7 R101-104 K	Venkel
2	C18,C31	0.1uF		16V	±20%	X7R	C0603	C0603X7 R160-104 M	Venkel
2	C101, C102	680pF	Y3	250V	±15%	Y3	C1808	GA342Q R7GD681 KW01L	MuRata
2	D1,D4	ES1B	1.0A	100V		Fast	DO-214A C	ES1B	Diodes Inc.
1	D2	MBRS310 OT3	3A	100V		Schottky	DO-214A B	MBRS310 OT3	On Semi
2	D3,D5	GREEN	30mA	2.2V		SMT	LED-0805 -K	LTST-C17 0GKT	LITE_ON INC
8	D21,D22,D23,D 24,D29,D30,D3 1,D32	SMAJ58A	400W	58V		GP	DO-214A C	SMAJ58A	Littelfuse
9	JP3,JP6, JP8,JP9, JP10, JP11,JP12, JP13,JP14	JUMPER				Header	CONN1X 2	TSW-102- 07-T-S	Samtec

Table 3. Si3454 Evaluation Board Bill of Materials (Continued)

Qty	Ref	Value	Rating	Voltage/C urrent	Tol	Type	PCB Footprint	Mfr Part Number	Mfr
1	JP7	HEADER 1x3				Header	CONN-1X 3	TSW-103- 07-T-S	Samtec
20	JS1,JS2,JS3,JS4,JS5,JS6,JS7,JS8,JS9,JS10,JS11,JS12,JS13,JS14,JS15,JS16,JS17,JS18,JS19,JS20	Jumper Shunt				Shunt	N/A	SNT-100- BK-T	Samtec
3	J1,J5,J10	HEADER 4x3				Header	CONN3X 4	TSW-104- 07-G-T	Samtec
1	J2	HEADER 5x2				Header	CONN2X 5	TSW-105- 07-T-D	Samtec
1	J3	CONN TRBLK 2				TERM BLK MALE	CONN-TB -1757242	1757242	PHOENIX CON- TACT
1	J8	HEADER 8x2				Header	CONN2X 8-TSM	TSM-108- 01-T-DV	Samtec
1	J9	HEADER 10x2				Header	CONN2X 10-2MM	TMM-110- 01-T-D	Samtec
1	L1	100uH	1.0 A		±20%	Shielded	IND-CTSL F1045	CTSLF10 45-101M	Central Tech
4	MH1,MH2, MH3,MH4	4-40				HDW	MH-125N P	NSS-4-4- 01	Richco Plastic Co
1	M1	FQT5P10	1.0A	100V		P-CHNL	SOT223- GDS	FQT5P10	Fairchild
1	PCB1	Si3454-E VB REV 1.0				BARE PCB	N/A	Si3454-E VB REV 1.0	SiLabs
8	Q1,Q2,Q3, Q4,Q9,Q10,Q11,Q12	FDMC361 2	12A	100V		N-CHNL	POW- ER33	FDMC361 2	Fairchild
3	R1,R2,R133	10K	1/10W		±1%	ThickFilm	R0603	CR0603-1 0W-1002 F	Venkel
2	R3,R4	1K	1/10W		±1%	ThickFilm	R0603	CR0603-1 0W-1001 F	Venkel
1	R5	1K	1/16W		±5%	ThickFilm	R0402	CR0402-1 6W-102J	Venkel

# Si3454-KIT

**Table 3. Si3454 Evaluation Board Bill of Materials (Continued)**

Qty	Ref	Value	Rating	Voltage/C urrent	Tol	Type	PCB Footprint	Mfr Part Number	Mfr
3	R16,R108, R132	0	1A			ThickFilm	R0603	CR0603-1 6W-000	Venkel
2	R17,R106	330	1/10W		±1%	ThickFilm	R0805	CR0805-1 0W-3300 F	Venkel
1	R18	44.2K	1/10W		±1%	ThickFilm	R0603	CR0603-1 0W-4422 F	Venkel
8	R81,R84,R87,R 92,R107, R110,R113, R118	0.25	1/4W		±1%	ThickFilm	R0805	LCR0805- R250F	Venkel
1	R134	1	1/4W		±1%	ThickFilm	R1206	CR1206-4 W-1R00F	Venkel
1	R139	3.24K	1/10W		±1%	ThickFilm	R0603	CR0603-1 0W-3241 F	Venkel
1	R140	6.49K	1/16W		±1%	ThickFilm	R0603	CR0603-1 6W-6491 F	Venkel
1	R141	13.0K	1/16W		±1%	ThickFilm	R0603	CR0603-1 6W-1302 F	Venkel
1	R142	26.1K	1/16W		±1%	ThickFilm	R0603	CR0603-1 6W-2612 F	Venkel
4	SO1,SO2, SO3,SO4	STAND- OFF				HDW		2397	SPC Technology
1	SW1	SW PUSH- BUTTON	50mA	12Vdc		Tactile	SW4N6.5 X4.5-PB	101-0161- EV	Mountain Switch
4	TPV1,TPV2, TPV3,TPV4	TPV				PCB Fea- ture	VIA-TP	N/A	N/A

**Table 3. Si3454 Evaluation Board Bill of Materials (Continued)**

Qty	Ref	Value	Rating	Voltage/C urrent	Tol	Type	PCB Footprint	Mfr Part Number	Mfr
24	TP1,TP2,TP3,TP4,TP6,TP7,TP8,TP9,TP10,TP11,TP12,TP13,TP16,TP17,TP18,TP21,TP29,TP30,TP31,TP32,TP33,TP36,TP37,TP38	BLACK				Loop	TEST-POINT	151-203-RC	Kobiconn
2	TP5,TP20	RED				Loop	TEST-POINT	151-207-RC	Kobiconn
1	U1	Si8605	3750 VRMS			Isolator	SO16N6.0P1.27	Si8605AC-B-IS1	SiLabs
2	U2,U3	Si3454		50V		PSE	QFN38N5X7P0.5	Si3454-A-FM	SiLabs

## 7.5. RJ45 Connector Board Schematics

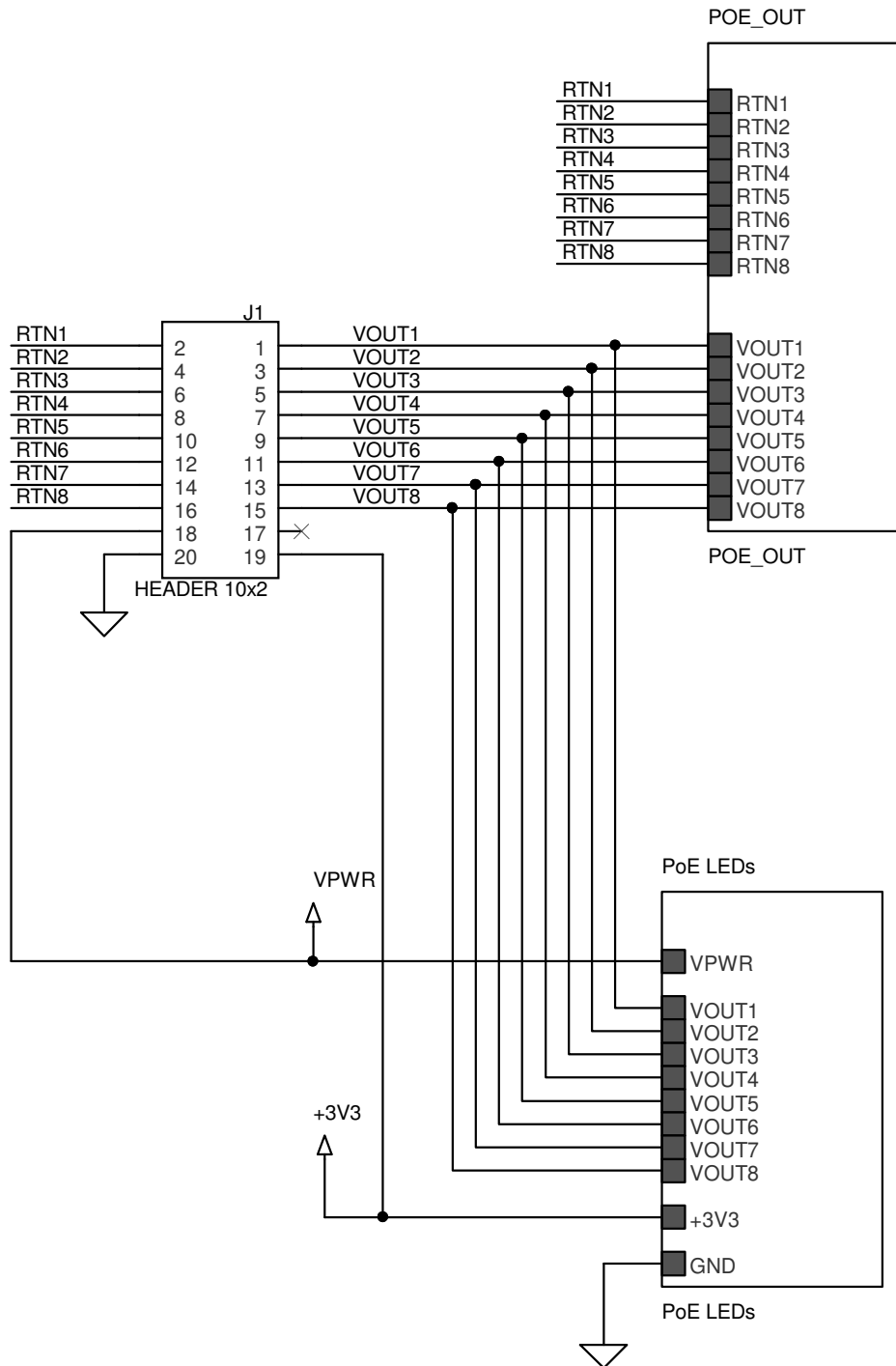
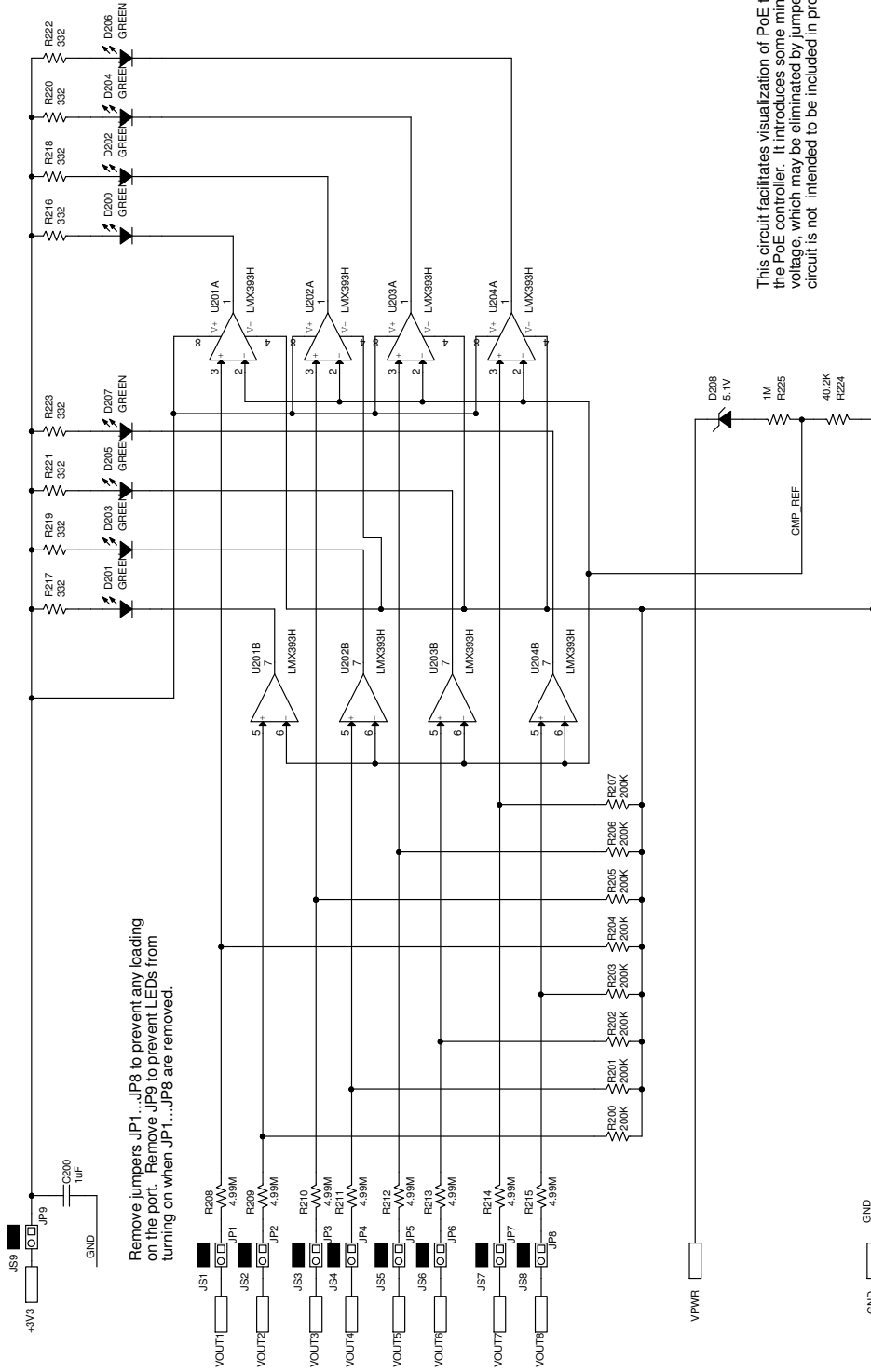

Figure 25. Connector Board Top Level



Remove jumpers JP1...JP8 to prevent any loading on the port. Remove JP9 to prevent LEDs from turning on when JP1...JP8 are removed.

This circuit facilitates visualization of PoE test voltages applied by the PoE controller. It introduces some minor error in port detection voltage, which may be eliminated by jumper disconnection. This circuit is not intended to be included in production designs.

Figure 26. Connector Board Comparators and LEDs

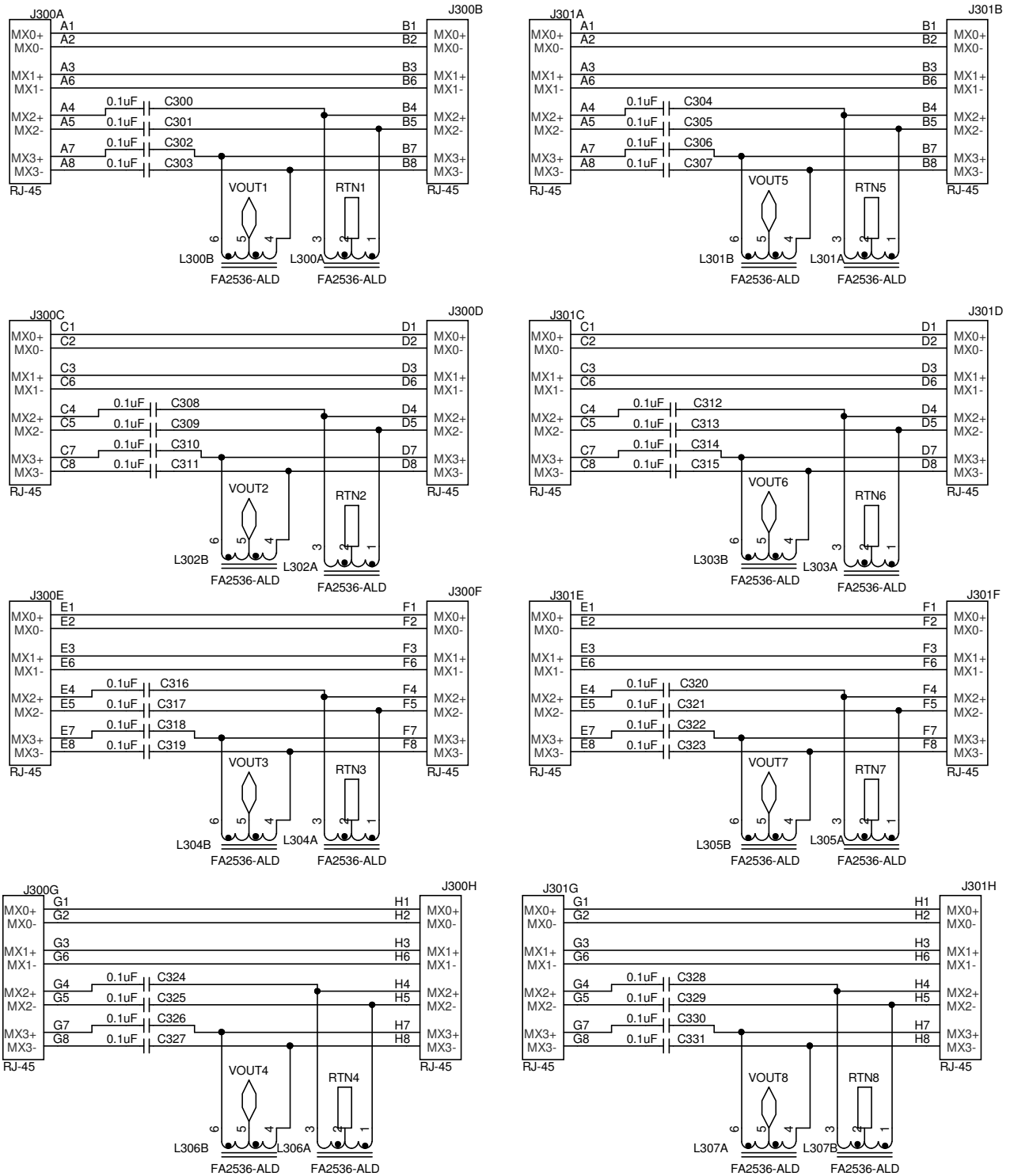

Figure 27. Connector Board Connectors and Coupling Circuits



7.6. Connector Board Layout

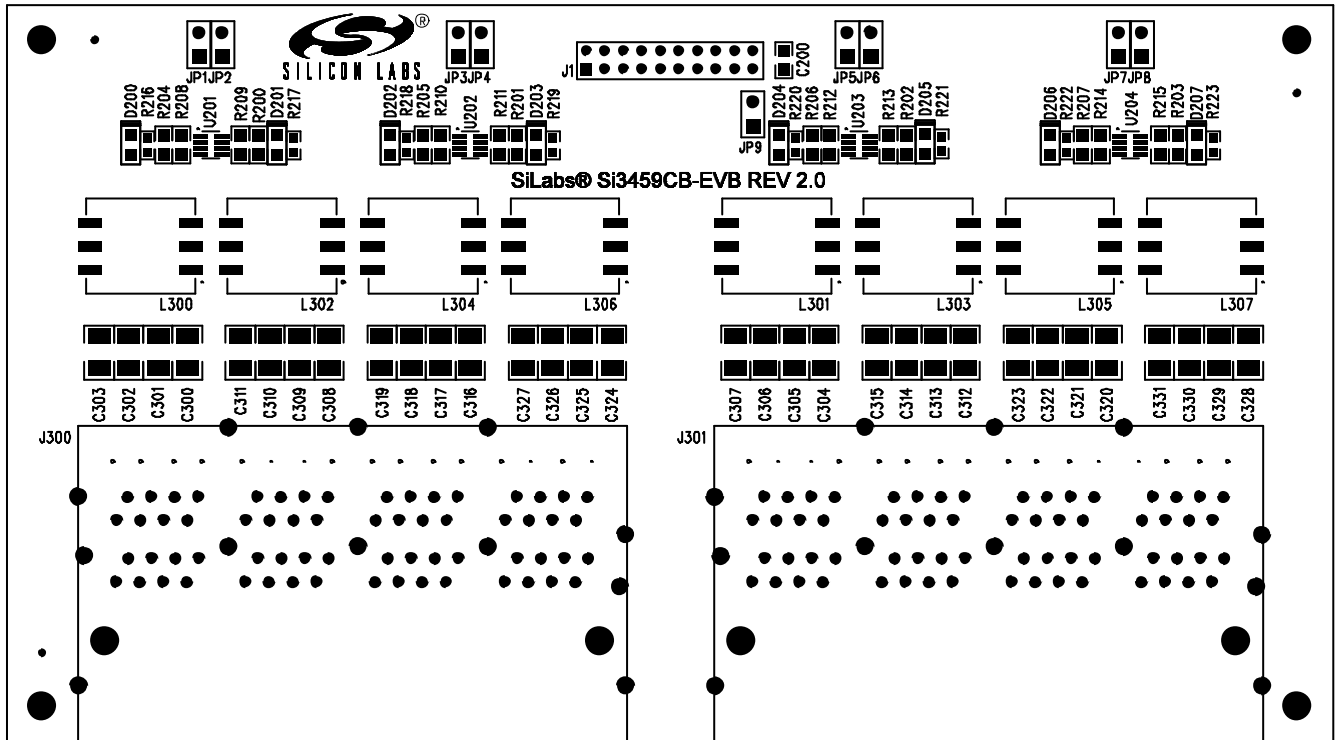

Figure 28. Connector Board Top Silkscreen

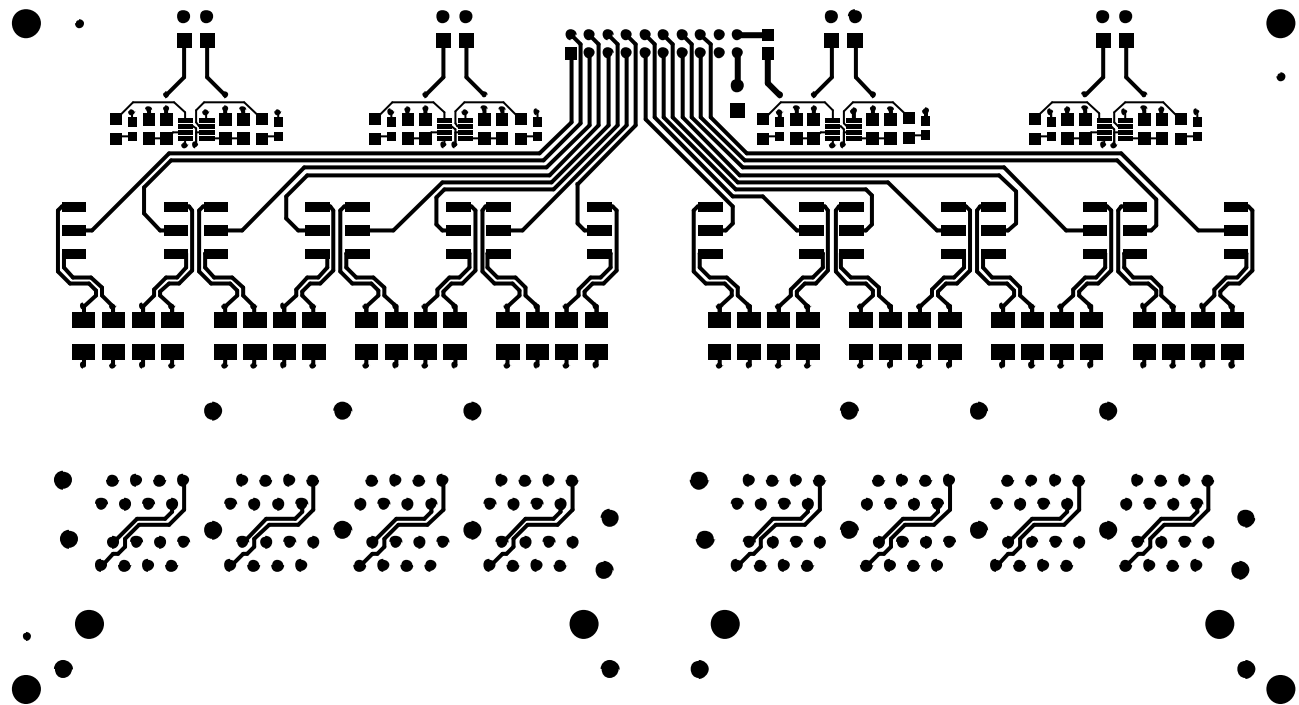

Figure 29. Connector Board Top Side

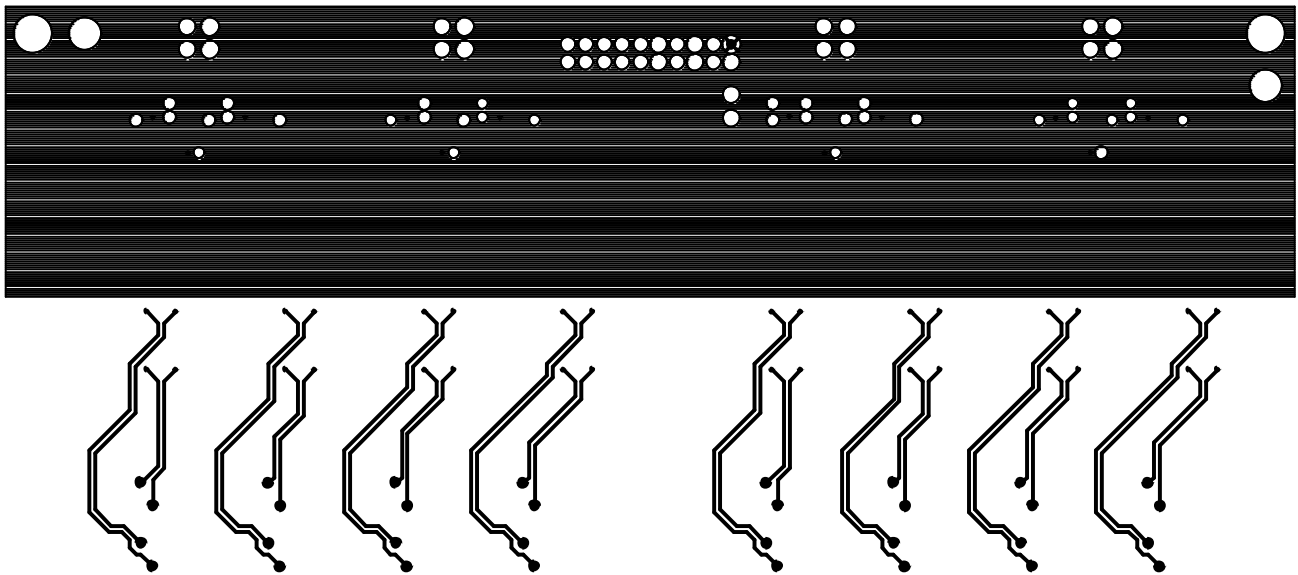

Figure 30. Connector Board Ground Layer

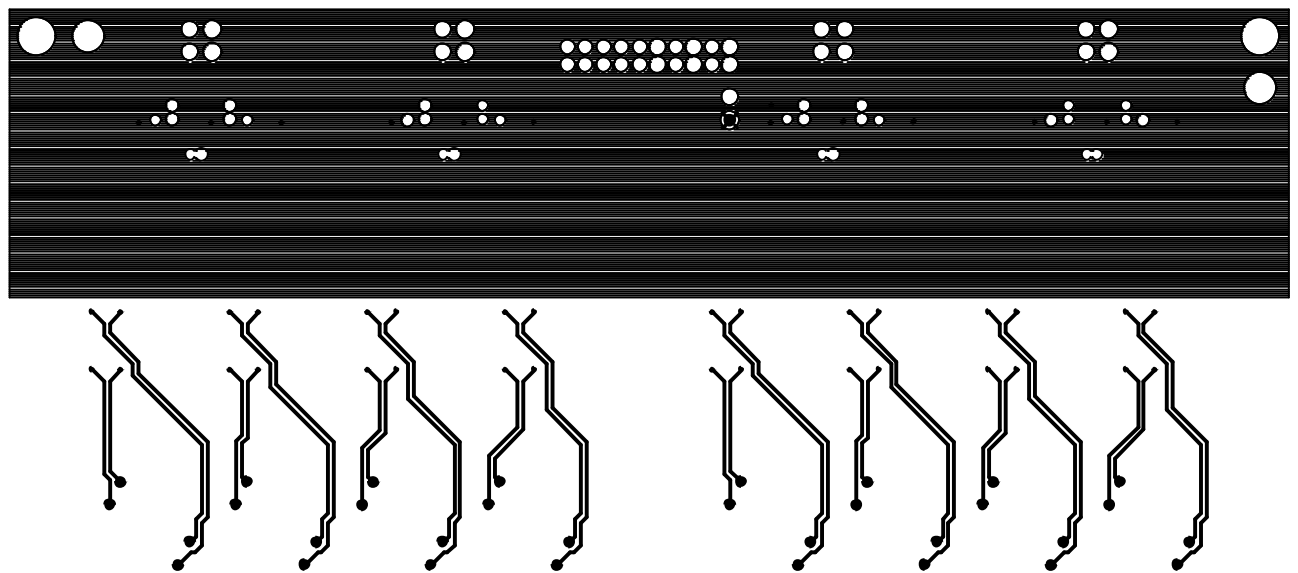

Figure 31. Connector Board Power Layer

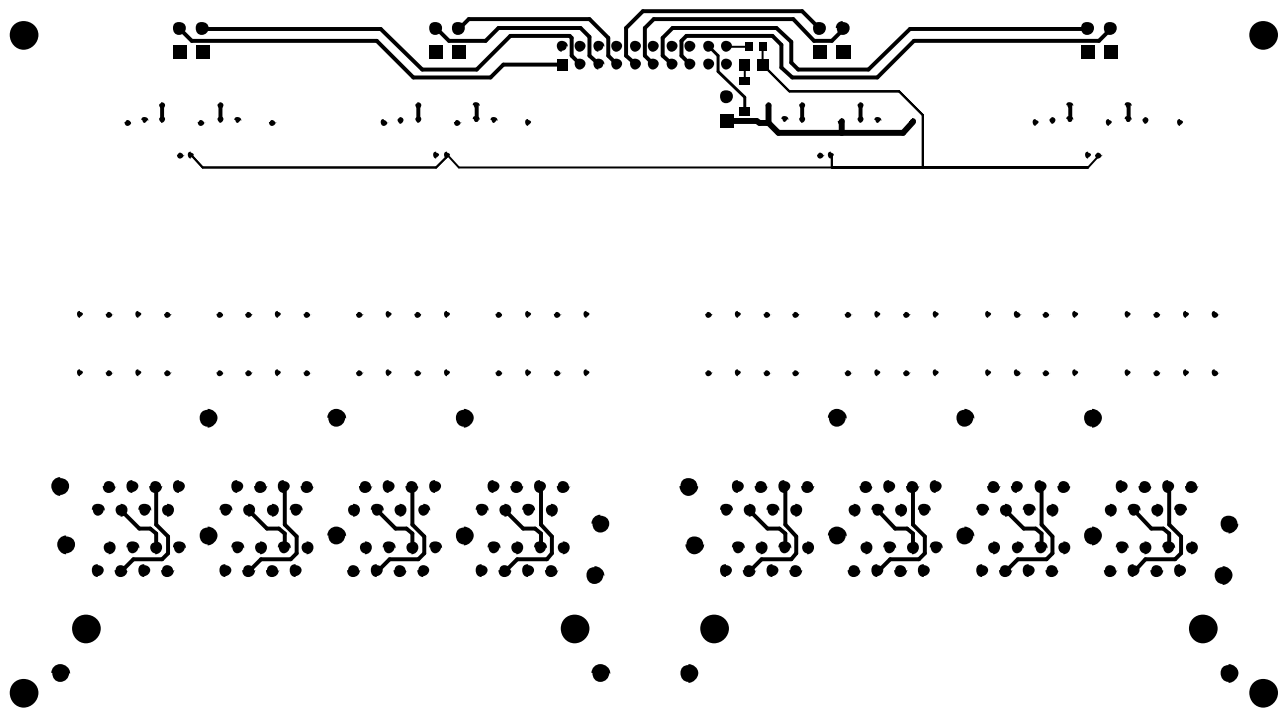

Figure 32. Connector Board Bottom Side

# Si3454-KIT

## 7.7. Connector Board Bill of Materials

Table 4. Connector Board Bill of Materials

Qty	Ref	Value	Rating	Voltage/ Current	Tol	Type	PCB Footprint	Mfr Part Number	Mfr
1	C200	1 $\mu$ F		16 V	$\pm$ 20%	X7R	C0805	C0805X7R160-105M	Venkel
32	C300, C301, C302, C303, C304, C305, C306, C307, C308, C309, C310, C311, C312, C313, C314, C315, C316, C317, C318, C319, C320, C321, C322, C323, C324, C325, C326, C327, C328, C329, C330, C331	0.1 $\mu$ F		250 V	$\pm$ 20%	X7R	C1210	C1210X7R251-104M	Venkel
8	D200, D201, D202, D203, D204, D205, D206, D207	Green	30 mA	2.2 V		SMT	LED-0805-K	LTST-C170GKT	Lite On
1	D208	5.1 V	500 mW	5.1 V	5%	Zener	SOD-123	MMSZ4689T1G	On Semi
1	J1	Header	10x2			Header	CONN2X10-2MM	TMM-110-01-T-D	Samtec
2	J300	RJ-45				Receptacle	RJ45-8PORT	44170-0001	Molex
9	JP1, JP2, JP3, JP4, JP5, JP6, JP7, JP8, JP9	Jumper				Header	CONN1X2	TSW-102-07-T-S	Samtec
9	JS1, JS2, JS3, JS4, JS5, JS6, JS7, JS8, JS9	Jumper			Shunt	Shunt	N/A	SNT-100-BK-T	Samtec
8	L300, L301, L302, L303, L304, L305, L306, L307	FA2536-ALD	675 $\mu$ H			Ethernet	IND-FA2536	FA2536-ALD	Coilcraft
4	MH1, MH2, MH3, MH4	4-40				HDW		NSS-4-4-01	Richco Plastic Co.

Table 4. Connector Board Bill of Materials (Continued)

Qty	Ref	Value	Rating	Voltage/ Current	Tol	Type	PCB Footprint	Mfr Part Number	Mfr
8	R200, R201, R202, R203, R204, R205, R206, R207	200 k $\Omega$	1/10 W	$\pm 1\%$		ThickFilm	R0805	CR0805-10W-2003F	Venkel
8	R208, R209, R210, R211, R212, R213, R214, R215	4.99 M $\Omega$	1/8 W	$\pm 1\%$		ThickFilm	R0805	CR0805-8W-4994FT	Venkel
8	R216, R217, R218, R219, R220, R221, R222, R223	332 $\Omega$	1/10 W	$\pm 1\%$		ThickFilm	R0603	CR0603-10W-3320F	Venkel
1	R224	40.2 k $\Omega$	1/10 W	$\pm 1\%$		ThickFilm	R0603	CR0603-10W-4022F	Venkel
1	R225	1 M $\Omega$	1/10 W	$\pm 1\%$		ThickFilm	R0805	CR0805-10W-1004F	Venkel
4	SO1, SO2, SO3, SO4	Standoff				HDW	2397	SPC_Technology	Technology
4	U201, U202, U203, U204	LMX393H	714 mW	5.5 V		Dual	SOT23-8N	LMX393HAKA-T	Maxim

# Si3454-KIT

---

## 8. Ordering Guide

Due to the unique high-voltage and high-power design considerations, Silicon Labs recommends that the reference designs be followed closely. Visit the Silicon Labs Technical Support web page and register to submit a technical support request, particularly if you are not closely following the recommended reference design.

**Table 5. Si3454-KIT Ordering Guide**

Ordering Part Number	Description
Si3454-KIT	Evaluation board kit for Si3454, 8-port midspan evaluation board reference design. Populated with Si3454 devices. Refer to the Si3454 data sheet Ordering Guide section for current ordering and device configuration information.
Si3454-XXX-IM	Ordering part number for Si3454 devices. X = device revision; YY = firmware revision. Refer to the Si3454 data sheet Ordering Guide section for current ordering and device configuration information.

## APPENDIX—CHECKING WHETHER THE DRIVER IS INSTALLED

To check whether the driver is installed, open the Control Panel and click the Device Manager icon. The screen shown in Figure 33 will appear. Click on “Multi-port serial adapters”, and, if it has installed, the driver will appear as “Silicon Laboratories PoE USB Device”.

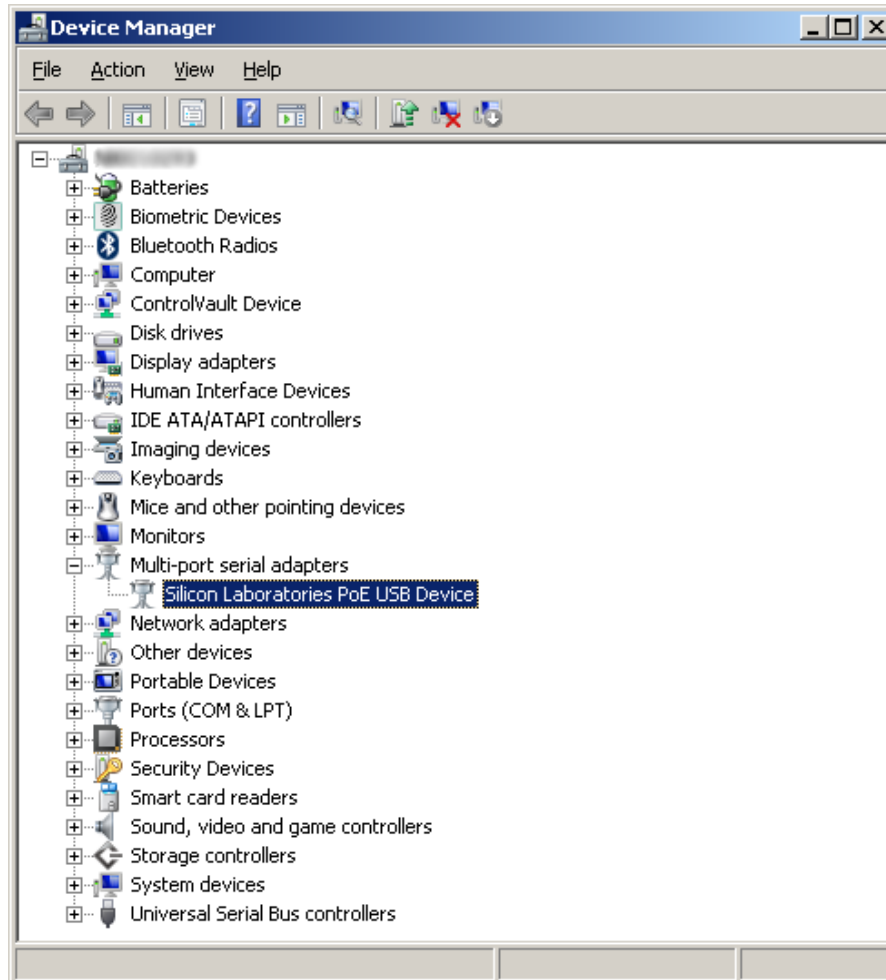
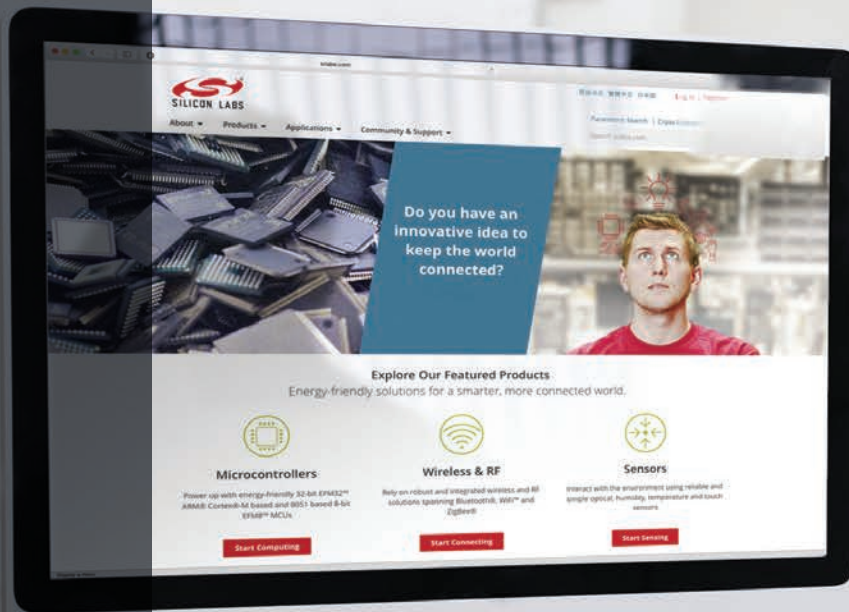

Figure 33. Device Manager



Smart.  
Connected.  
Energy-Friendly.



**Products**  
[www.silabs.com/products](http://www.silabs.com/products)

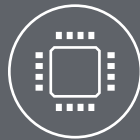

**Quality**  
[www.silabs.com/quality](http://www.silabs.com/quality)



**Support and Community**  
[community.silabs.com](http://community.silabs.com)

**Disclaimer**

Silicon Labs intends to provide customers with the latest, accurate, and in-depth documentation of all peripherals and modules available for system and software implementers using or intending to use the Silicon Labs products. Characterization data, available modules and peripherals, memory sizes and memory addresses refer to each specific device, and "Typical" parameters provided can and do vary in different applications. Application examples described herein are for illustrative purposes only. Silicon Labs reserves the right to make changes without further notice to the product information, specifications, and descriptions herein, and does not give warranties as to the accuracy or completeness of the included information. Without prior notification, Silicon Labs may update product firmware during the manufacturing process for security or reliability reasons. Such changes will not alter the specifications or the performance of the product. Silicon Labs shall have no liability for the consequences of use of the information supplied in this document. This document does not imply or expressly grant any license to design or fabricate any integrated circuits. The products are not designed or authorized to be used within any FDA Class III devices, applications for which FDA premarket approval is required or Life Support Systems without the specific written consent of Silicon Labs. A "Life Support System" is any product or system intended to support or sustain life and/or health, which, if it fails, can be reasonably expected to result in significant personal injury or death. Silicon Labs products are not designed or authorized for military applications. Silicon Labs products shall under no circumstances be used in weapons of mass destruction including (but not limited to) nuclear, biological or chemical weapons, or missiles capable of delivering such weapons. Silicon Labs disclaims all express and implied warranties and shall not be responsible or liable for any injuries or damages related to use of a Silicon Labs product in such unauthorized applications.

**Trademark Information**

Silicon Laboratories Inc.®, Silicon Laboratories®, Silicon Labs®, SiLabs® and the Silicon Labs logo®, Bluegiga®, Bluegiga Logo®, ClockBuilder®, CMEMS®, DSPLL®, EFM®, EFM32®, EFR, Ember®, Energy Micro, Energy Micro logo and combinations thereof, "the world's most energy friendly microcontrollers", Ember®, EZLink®, EZRadio®, EZRadioPRO®, Gecko®, Gecko OS, Gecko OS Studio, ISOModem®, Precision32®, ProSLIC®, Simplicity Studio®, SiPHY®, Telegesis, the Telegesis Logo®, USBXpress®, Zentri, the Zentri logo and Zentri DMS, Z-Wave®, and others are trademarks or registered trademarks of Silicon Labs. ARM, CORTEX, Cortex-M3 and THUMB are trademarks or registered trademarks of ARM Holdings. Keil is a registered trademark of ARM Limited. Wi-Fi is a registered trademark of the Wi-Fi Alliance. All other products or brand names mentioned herein are trademarks of their respective holders.



Silicon Laboratories Inc.  
400 West Cesar Chavez  
Austin, TX 78701  
USA

<http://www.silabs.com>