

LM4940 Boomer® Audio Power Amplifier Series 6W Stereo Audio Power Amplifier

Check for Samples: [LM4940](#)

FEATURES

- Click and Pop Circuitry Eliminates Noise During Turn-On and Turn-Off Transitions
- Low Current, Active-Low Shutdown Mode
- Low Quiescent Current
- Stereo 6W Output, $R_L = 4\Omega$
- Short Circuit Protection
- Unity-Gain Stable
- External Gain Configuration Capability

APPLICATIONS

- Flat Panel Monitors
- Flat Panel TVs
- Computer Sound Cards

KEY SPECIFICATIONS

- Quiescent Power Supply Current: 40mA (max) (SE)
- P_{OUT}
 $V_{DD} = 14.4V$, $R_L = 4\Omega$, 10% THD+N: 6 W (typ)
- Shutdown Current: 40 μ A (typ)

TYPICAL APPLICATION

DESCRIPTION

The LM4940 is a dual audio power amplifier primarily designed for demanding applications in flat panel monitors and TVs. It is capable of delivering 6 watts per channel to a 4 Ω load with less than 10% THD+N while operating on a 14.4V_{DC} power supply.

Boomer™ audio power amplifiers were designed specifically to provide high quality output power with a minimal amount of external components. The LM4940 does not require bootstrap capacitors or snubber circuits. Therefore, it is ideally suited for display applications requiring high power and minimal size.

The LM4940 features a low-power consumption active-low shutdown mode. Additionally, the LM4940 features an internal thermal shutdown protection mechanism along with short circuit protection.

The LM4940 contains advanced pop and click circuitry that eliminates noises which would otherwise occur during turn-on and turn-off transitions.

The LM4940 is a unity-gain stable and can be configured by external gain-setting resistors.

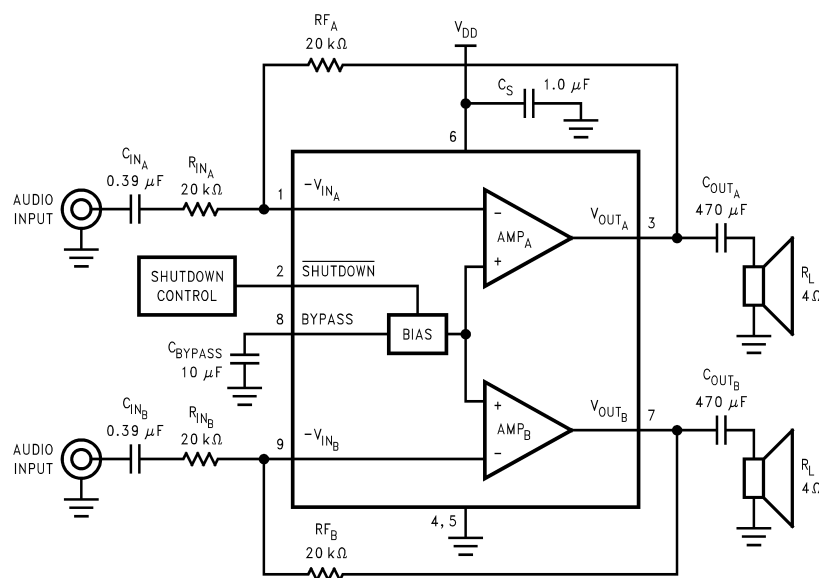
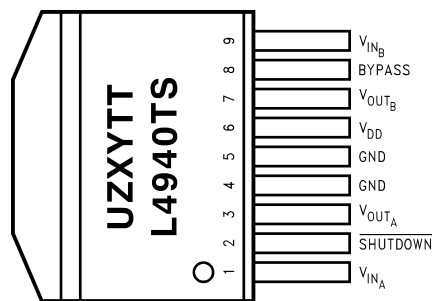

Figure 1. Typical Stereo Audio Amplifier Application Circuit



Please be aware that an important notice concerning availability, standard warranty, and use in critical applications of Texas Instruments semiconductor products and disclaimers thereto appears at the end of this data sheet.

Boomer is a trademark of Texas Instruments, Inc.
All other trademarks are the property of their respective owners.

CONNECTION DIAGRAM

U = Wafer Fab Code, Z = Assembly Plant Code, XY = Date Code, TT = Die Traceability

**Plastic Package, DDPAK
Top View
See Package Number KTW**



These devices have limited built-in ESD protection. The leads should be shorted together or the device placed in conductive foam during storage or handling to prevent electrostatic damage to the MOS gates.

ABSOLUTE MAXIMUM RATINGS⁽¹⁾⁽²⁾⁽³⁾

Supply Voltage (pin 6, referenced to GND, pins 4 and 5)		18.0V
Storage Temperature		-65°C to +150°C
Input Voltage	Pins 3 and 7	-0.3V to $V_{DD} + 0.3V$
	Pins 1, 2, 8, and 9	-0.3V to 9.5V
Power Dissipation ⁽⁴⁾		Internally limited
ESD Susceptibility ⁽⁵⁾		2000V
ESD Susceptibility ⁽⁶⁾		200V
Junction Temperature		150°C
Thermal Resistance	θ_{JC} (KTW)	4°C/W
	θ_{JA} (KTW) ⁽⁴⁾	20°C/W
	θ_{JC} (NEC)	4°C/W
	θ_{JA} (NEC) ⁽⁴⁾	20°C/W

- (1) All voltages are measured with respect to the GND pin, unless otherwise specified.
- (2) Absolute Maximum Ratings indicate limits beyond which damage to the device may occur. Operating Ratings indicate conditions for which the device is functional, but do not ensure specific performance limits. Electrical Characteristics state DC and AC electrical specifications under particular test conditions which ensure performance limits. This assumes that the device is within the Operating Ratings. Specifications are not ensured for parameters where no limit is given, however, the typical value is a good indication of device performance.
- (3) If Military/Aerospace specified devices are required, please contact the Texas Instruments Sales Office/ Distributors for availability and specifications.
- (4) The maximum power dissipation must be derated at elevated temperatures and is dictated by T_{JMAX} , θ_{JA} , and the ambient temperature, T_A . The maximum allowable power dissipation is $P_{DMAX} = (T_{JMAX} - T_A) / \theta_{JA}$ or the given in Absolute Maximum Ratings, whichever is lower. For the LM4940 typical application (shown in [Figure 1](#)) with $V_{DD} = 12V$, $R_L = 4\Omega$ stereo operation the total power dissipation is 3.65W. $\theta_{JA} = 20^\circ C/W$ for both DDPAK and TO-220 packages mounted to 16in² heatsink surface area.
- (5) Human body model, 100pF discharged through a 1.5k Ω resistor.
- (6) Machine Model, 220pF–240pF discharged through all pins.

OPERATING RATINGS

Temperature Range ($T_{MIN} \leq T_A \leq T_{MAX}$)	$-40^\circ C \leq T_A \leq 85^\circ C$
Supply Voltage	$10V \leq V_{DD} \leq 16V$

ELECTRICAL CHARACTERISTICS $V_{DD} = 12V^{(1)(2)}$

The following specifications apply for $V_{DD} = 12V$, $A_V = 10$, $R_L = 4\Omega$, $f = 1kHz$ unless otherwise specified. Limits apply for $T_A = 25^\circ C$.

Symbol	Parameter	Conditions	LM4940		Units (Limits)
			Typical ⁽³⁾	Limit ⁽⁴⁾⁽⁵⁾	
I_{DD}	Quiescent Power Supply Current	$V_{IN} = 0V$, $I_O = 0A$, No Load	16	40	mA (max)
I_{SD}	Shutdown Current	$V_{SHUTDOWN} = GND^{(6)}$	40	100	μA (max)
V_{SDIH}	Shutdown Voltage Input High			2.0 $V_{DD}/2$	V (min) V (max)
V_{SDIL}	Shutdown Voltage Input Low			0.4	V (max)
P_O	Output Power	Single Channel			W (min)
		THD+N = 1%	3.1	2.8	
		THD+N = 10%	4.2		
		$V_{DD} = 14.4V$, THD+N = 10%	6.0		
THD+N	Total Harmonic Distortion + Noise	$P_O = 1W_{RMS}$, $A_V = 10$, $f = 1kHz$	0.15		%
ϵ_{OS}	Output Noise	A-Weighted Filter, $V_{IN} = 0V$, Input Referred	10		μV
X_{TALK}	Channel Separation	$P_O = 1W$	70		dB
PSRR	Power Supply Rejection Ratio	$V_{RIPPLE} = 200mV_{p-p}$ $f_{RIPPLE} = 1kHz$	56		dB

- (1) All voltages are measured with respect to the GND pin, unless otherwise specified.
- (2) Absolute Maximum Ratings indicate limits beyond which damage to the device may occur. Operating Ratings indicate conditions for which the device is functional, but do not ensure specific performance limits. Electrical Characteristics state DC and AC electrical specifications under particular test conditions which ensure performance limits. This assumes that the device is within the Operating Ratings. Specifications are not ensured for parameters where no limit is given, however, the typical value is a good indication of device performance.
- (3) Typical values are measured at $25^\circ C$ and represent the parametric norm.
- (4) Limits are specified to AOQL (Average Outgoing Quality Level).
- (5) Datasheet min/max specification limits are specified by design, test, or statistical analysis.
- (6) Shutdown current is measured in a normal room environment. The Shutdown pin should be driven as close as possible to GND for minimum shutdown current.

TYPICAL APPLICATION

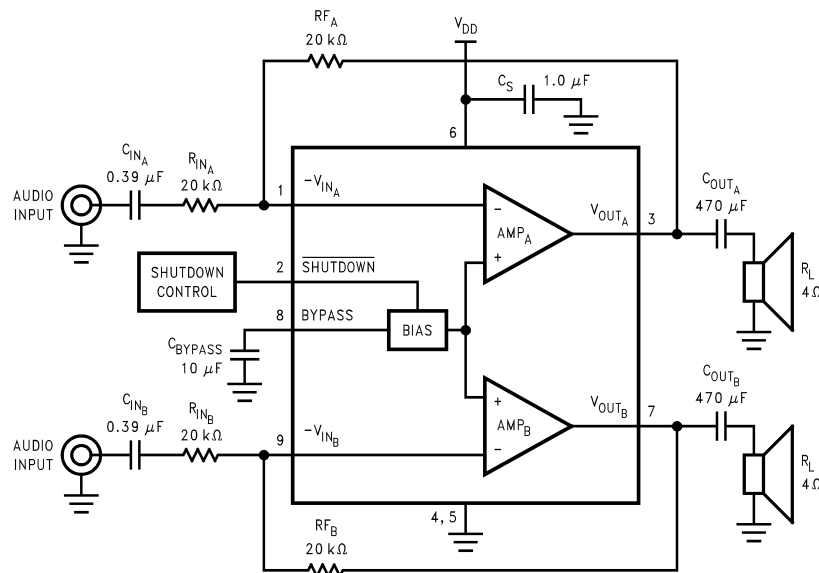

Figure 2. Typical Stereo Audio Amplifier Application Circuit

EXTERNAL COMPONENTS DESCRIPTION

 Refer to [Figure 1](#).

Components		Functional Description
1.	R_{IN}	This is the inverting input resistance that, along with R_F , sets the closed-loop gain. Input resistance R_{IN} and input capacitance C_{IN} form a high pass filter. The filter's cutoff frequency is $f_c = 1/(2\pi R_{IN} C_{IN})$.
2.	C_{IN}	This is the input coupling capacitor. It blocks DC voltage at the amplifier's inverting input. C_{IN} and R_{IN} create a highpass filter. The filter's cutoff frequency is $f_c = 1/(2\pi R_{IN} C_{IN})$. Refer to the SELECTING EXTERNAL COMPONENTS section for an explanation of determining C_{IN} 's value.
3.	R_F	This is the feedback resistance that, along with R_i , sets closed-loop gain.
4.	C_S	The supply bypass capacitor. Refer to the POWER SUPPLY BYPASSING section for information about properly placing, and selecting the value of, this capacitor.
5.	C_{BYPASS}	This capacitor filters the half-supply voltage present on the BYPASS pin. Refer to the SELECTING EXTERNAL COMPONENTS for information about properly placing, and selecting the value of, this capacitor.
6.	C_{OUT}	This is the output coupling capacitor. It blocks the nominal $V_{DD}/2$ voltage present at the output and prevents it from reaching the load. C_{OUT} and R_L form a high pass filter whose cutoff frequency is $f_c = 1/(2\pi R_L C_{OUT})$. Refer to the SELECTING EXTERNAL COMPONENTS section for an explanation of determining C_{OUT} 's value.

TYPICAL PERFORMANCE CHARACTERISTICS

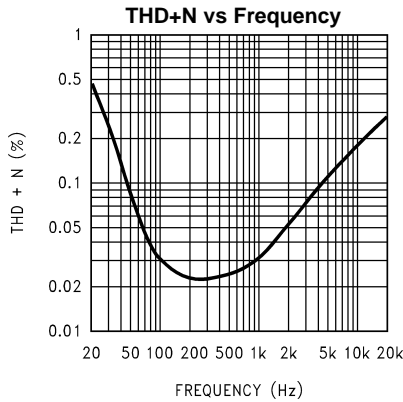

$V_{DD} = 12V$, $R_L = 4\Omega$, SE operation,
both channels driven and loaded (average shown)
 $P_{OUT} = 1W$, $A_V = 1$

Figure 3.

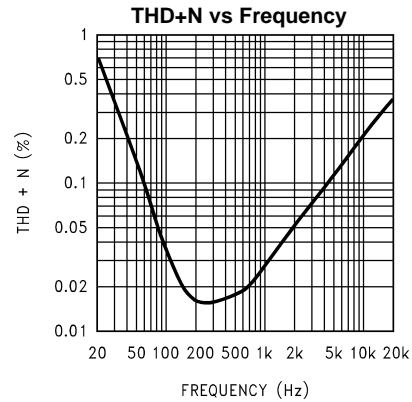

$V_{DD} = 12V$, $R_L = 4\Omega$, SE operation,
both channels driven and loaded (average shown),
 $P_{OUT} = 2.5W$, $A_V = 1$

Figure 4.

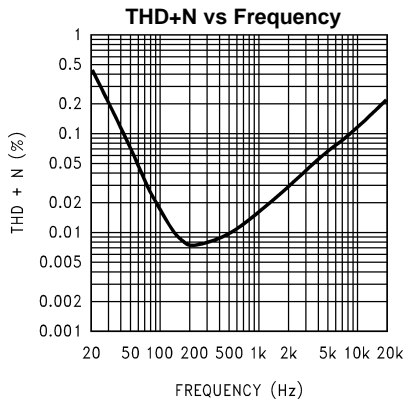

$V_{DD} = 12V$, $R_L = 8\Omega$, SE operation,
both channels driven and loaded (average shown),
 $P_{OUT} = 1W$, $A_V = 1$

Figure 5.

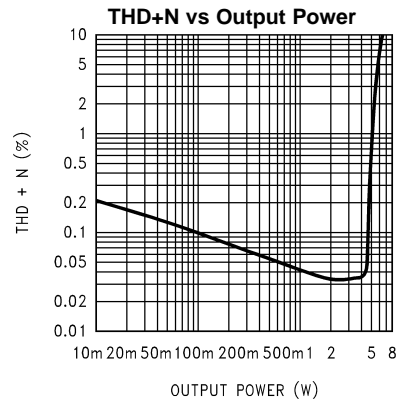

$V_{DD} = 14.4V$, $R_L = 4\Omega$, SE operation, $A_V = 1$
single channel driven/single channel measured,
 $f_{IN} = 1kHz$

Figure 6.

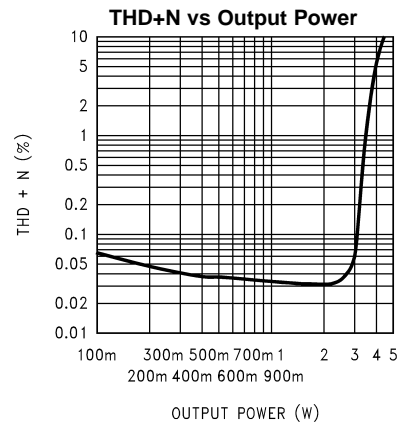

$V_{DD} = 12V$, $R_L = 4\Omega$, SE operation, $A_V = 1$
single channel driven/single channel measured,
 $f_{IN} = 1kHz$

Figure 7.

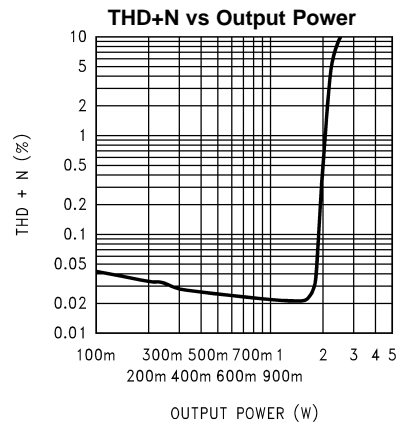

$V_{DD} = 12V$, $R_L = 8\Omega$, SE operation, $A_V = 1$
single channel driven/single channel measured,
 $f_{IN} = 1kHz$

Figure 8.

TYPICAL PERFORMANCE CHARACTERISTICS (continued)

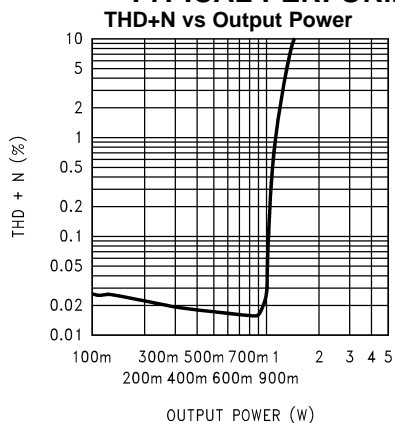

$V_{DD} = 12V$, $R_L = 16\Omega$, SE operation, $A_V = 1$
single channel driven/single channel measured,
 $f_{IN} = 1kHz$

Figure 9.

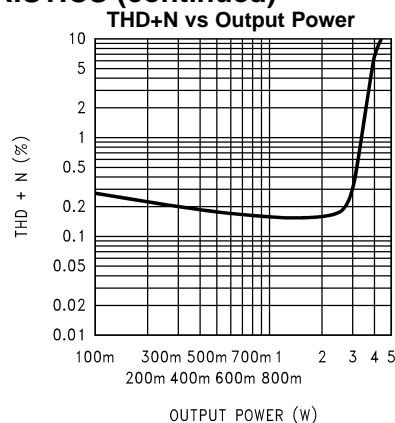

$V_{DD} = 12V$, $R_L = 4\Omega$, SE operation, $A_V = 10$
single channel driven/single channel measured,
 $f_{IN} = 1kHz$

Figure 10.

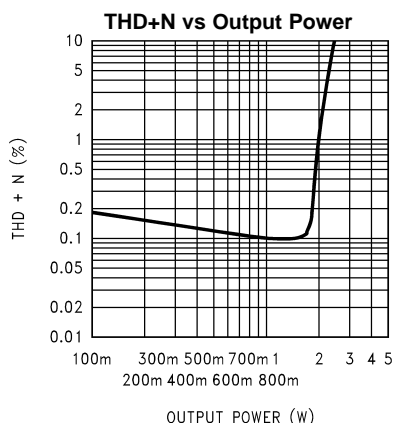

$V_{DD} = 12V$, $R_L = 8\Omega$, SE operation, $A_V = 10$
single channel driven/single channel measured,
 $f_{IN} = 1kHz$

Figure 11.

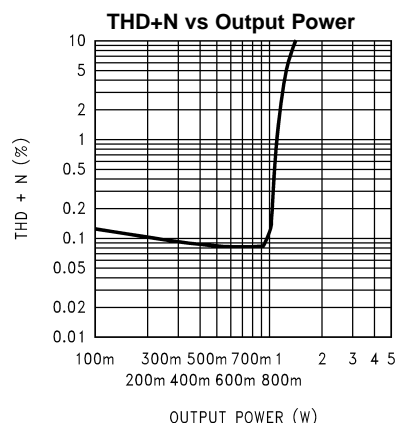

$V_{DD} = 12V$, $R_L = 16\Omega$, SE operation, $A_V = 10$
single channel driven/single channel measured,
 $f_{IN} = 1kHz$

Figure 12.

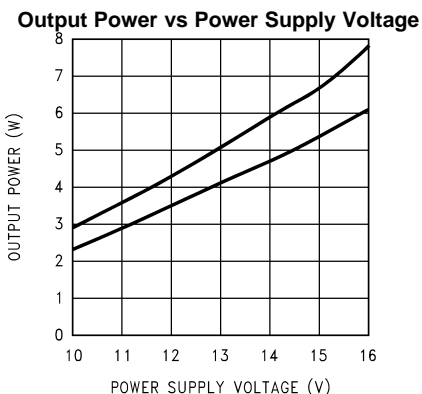

$R_L = 4\Omega$, SE operation, $f_{IN} = 1kHz$,
both channels driven and loaded (average shown),
at (from top to bottom at 12V): THD+N = 10%,
THD+N = 1%

Figure 13.

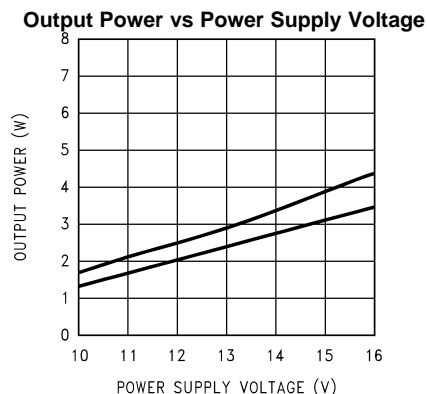

$R_L = 8\Omega$, SE operation, $f_{IN} = 1kHz$,
both channels driven and loaded (average shown),
at (from top to bottom at 12V): THD+N = 10%,
THD+N = 1%

Figure 14.

TYPICAL PERFORMANCE CHARACTERISTICS (continued)

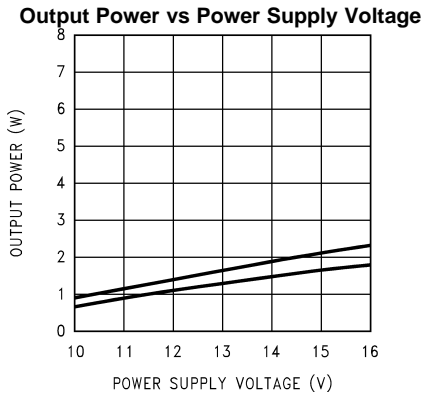

$R_L = 16\Omega$, SE operation, $f_{IN} = 1\text{kHz}$, both channels driven and loaded (average shown), at (from top to bottom at 12V): THD+N = 10%, THD+N = 1%

Figure 15.

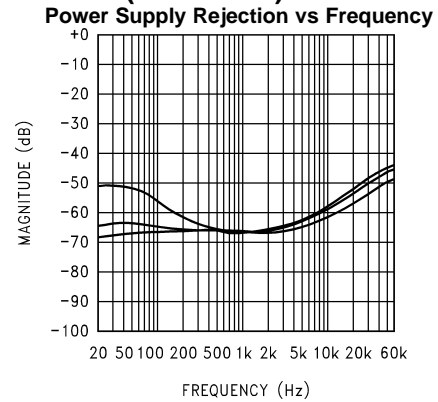

$V_{DD} = 12\text{V}$, $R_L = 8\Omega$, SE operation, $V_{RIPPLE} = 200\text{mV}_{p-p}$, at (from top to bottom at 60Hz): $C_{BYPASS} = 1\mu\text{F}$, $C_{BYPASS} = 4.7\mu\text{F}$, $C_{BYPASS} = 10\mu\text{F}$

Figure 16.

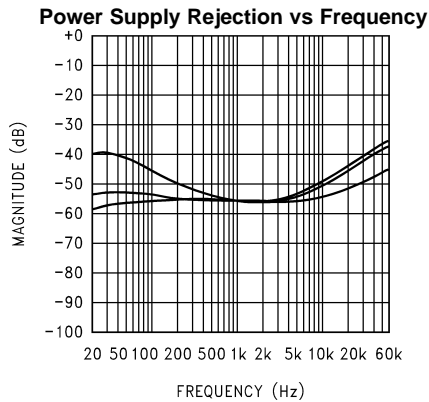

$V_{DD} = 12\text{V}$, $R_L = 8\Omega$, SE operation, $V_{RIPPLE} = 200\text{mV}_{p-p}$, $A_V = 10$, at (from top to bottom at 60Hz): $C_{BYPASS} = 1\mu\text{F}$, $C_{BYPASS} = 4.7\mu\text{F}$, $C_{BYPASS} = 10\mu\text{F}$

Figure 17.

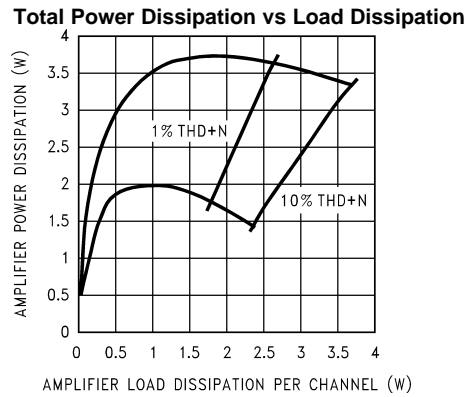

$V_{DD} = 12\text{V}$, SE operation, $f_{IN} = 1\text{kHz}$, at (from top to bottom at 1W): $R_L = 4\Omega$, $R_L = 8\Omega$

Figure 18.

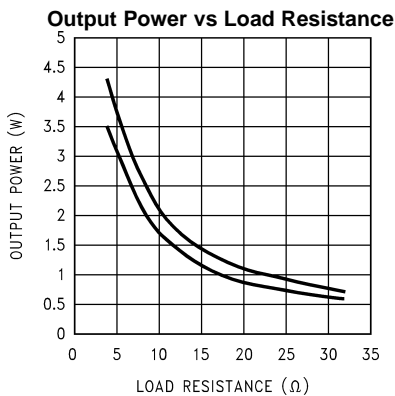

$V_{DD} = 12\text{V}$, SE operation, $f_{IN} = 1\text{kHz}$, both channels driven and loaded, at (from top to bottom at 15Ω): THD+N = 10%, THD+N = 1%

Figure 19.

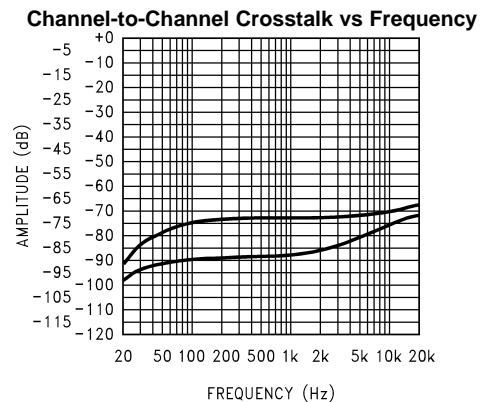

$V_{DD} = 12\text{V}$, $R_L = 4\Omega$, $P_{OUT} = 1\text{W}$, SE operation, at (from top to bottom at 1kHz): V_{INB} driven, V_{OUTA} measured; V_{INA} driven, V_{OUTB} measured

Figure 20.

TYPICAL PERFORMANCE CHARACTERISTICS (continued)

Channel-to-Channel Crosstalk vs Frequency

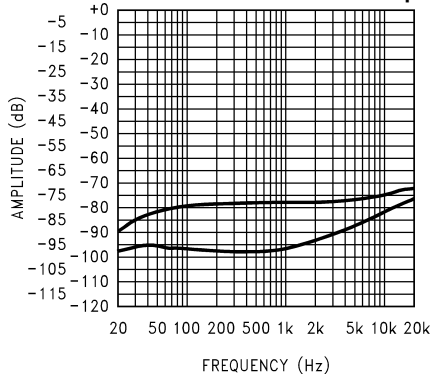

$V_{DD} = 12V$, $R_L = 8\Omega$, $P_{OUT} = 1W$, SE operation,
at (from top to bottom at 1kHz): V_{INB} driven,
 V_{OUTA} measured; V_{INA} driven, V_{OUTB} measured
Figure 21.

Power Supply Current vs Power Supply Voltage

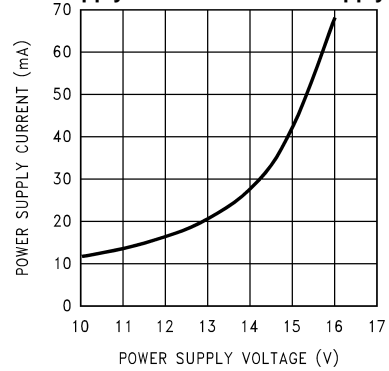

$R_L = 4\Omega$, SE operation
 $V_{IN} = 0V$, $R_{SOURCE} = 50\Omega$

Figure 22.

Clipping Voltage vs Power Supply Voltage

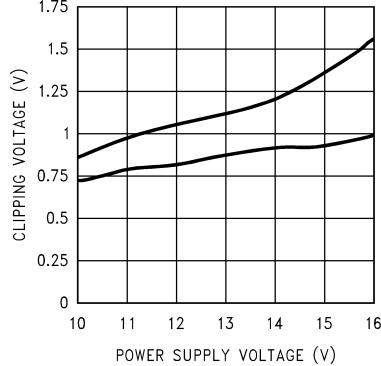

$R_L = 4\Omega$, SE operation, $f_{IN} = 1kHz$
both channels driven and loaded,
at (from top to bottom at 13V):
negative signal swing, positive signal swing
Figure 23.

Clipping Voltage vs Power Supply Voltage

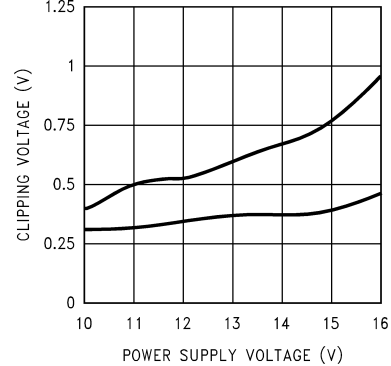

$R_L = 8\Omega$, SE operation, $f_{IN} = 1kHz$
both channels driven and loaded,
at (from top to bottom at 13V):
negative signal swing, positive signal swing
Figure 24.

Power Dissipation vs Ambient Temperature

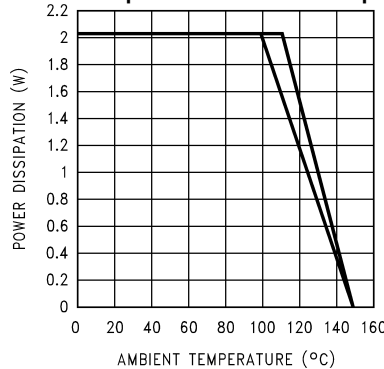

$V_{DD} = 12V$, $R_L = 8\Omega$ (SE), $f_{IN} = 1kHz$,
(from top to bottom at 120°C):
16in² copper plane heatsink area,
8in² copper plane heatsink area

Figure 25.

APPLICATION INFORMATION

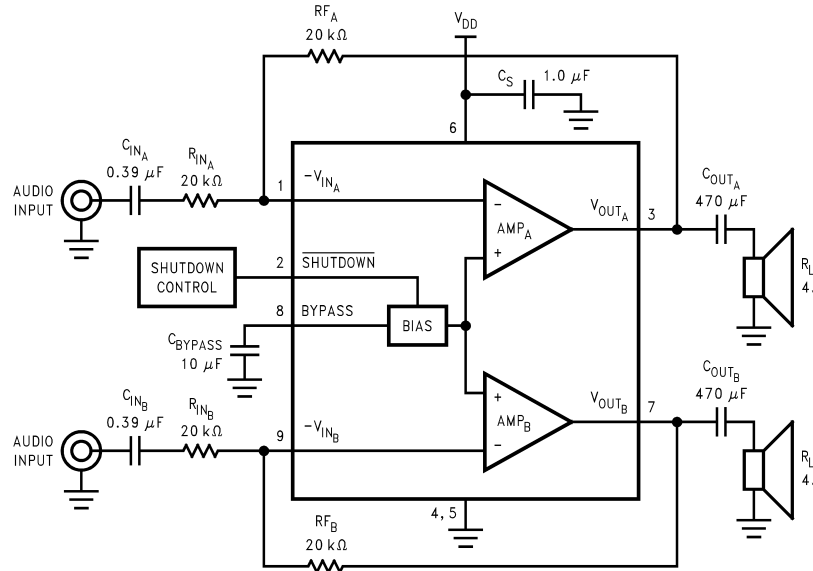

Figure 26. Typical LM4940 Stereo Amplifier Application Circuit

HIGH VOLTAGE BOOMER WITH INCREASED OUTPUT POWER

Unlike previous 5V Boomer amplifiers, the LM4940 is designed to operate over a power supply voltages range of 10V to 15V. Operating on a 12V power supply, the LM4940 will deliver 3.1W per channel into 4Ω loads with no more than 1% THD+N.

POWER DISSIPATION

Power dissipation is a major concern when designing a successful single-ended amplifier. Equation 1 states the maximum power dissipation point for a single-ended amplifier operating at a given supply voltage and driving a specified output load.

$$P_{\text{DMAX-SE}} = (V_{\text{DD}})^2 / (2\pi^2 R_L): \text{ Single Ended} \quad (1)$$

The LM4940's dissipation is twice the value given by Equation 1 when driving two SE loads. For a 12V supply and two 8Ω SE loads, the LM4940's dissipation is 1.82W.

The maximum power dissipation point (twice the value given by Equation 1 must not exceed the power dissipation given by Equation 2:

$$P_{\text{DMAX}}' = (T_{\text{JMAX}} - T_A) / \theta_{\text{JA}} \quad (2)$$

The LM4940's $T_{\text{JMAX}} = 150^\circ\text{C}$. In the KTW package, the LM4940's θ_{JA} is 20°C/W when the metal tab is soldered to a copper plane of at least 16in^2 . This plane can be split between the top and bottom layers of a two-sided PCB. Connect the two layers together under the tab with a 5×5 array of vias. For the NEC package, use an external heatsink with a thermal impedance that is less than 20°C/W . At any given ambient temperature T_A , use Equation 3 to find the maximum internal power dissipation supported by the IC packaging. Rearranging Equation 3 and substituting P_{DMAX} for P_{DMAX}' results in Equation 4. This equation gives the maximum ambient temperature that still allows maximum stereo power dissipation without violating the LM4940's maximum junction temperature.

$$T_A = T_{JMAX} - P_{DMAX-SE}\theta_{JA} \quad (3)$$

For a typical application with a 12V power supply and two 4Ω SE loads, the maximum ambient temperature that allows maximum stereo power dissipation without exceeding the maximum junction temperature is approximately 113°C for the KTW package.

$$T_{JMAX} = P_{DMAX-SE}\theta_{JA} + T_A \quad (4)$$

Equation 4 gives the maximum junction temperature T_{JMAX} . If the result violates the LM4940's 150°C, reduce the maximum junction temperature by reducing the power supply voltage or increasing the load resistance. Further allowance should be made for increased ambient temperatures.

The above examples assume that a device is operating around the maximum power dissipation point. Since internal power dissipation is a function of output power, higher ambient temperatures are allowed as output power or duty cycle decreases.

If the result of **Equation 3** is greater than that of **Equation 4**, then decrease the supply voltage, increase the load impedance, or reduce the ambient temperature. Further, ensure that speakers rated at a nominal 4Ω do not fall below 3Ω. If these measures are insufficient, a heat sink can be added to reduce θ_{JA} . The heat sink can be created using additional copper area around the package, with connections to the ground pins, supply pin and amplifier output pins. Refer to the **TYPICAL PERFORMANCE CHARACTERISTICS** curves for power dissipation information at lower output power levels.

POWER SUPPLY VOLTAGE LIMITS

Continuous proper operation is ensured by never exceeding the voltage applied to any pin, with respect to ground, as listed in the **Absolute Maximum Ratings** section.

POWER SUPPLY BYPASSING

As with any power amplifier, proper supply bypassing is critical for low noise performance and high power supply rejection. Applications that employ a voltage regulator typically use a 10μF in parallel with a 0.1μF filter capacitors to stabilize the regulator's output, reduce noise on the supply line, and improve the supply's transient response. However, their presence does not eliminate the need for a local 1.0μF tantalum bypass capacitance connected between the LM4940's supply pins and ground. Do not substitute a ceramic capacitor for the tantalum. Doing so may cause oscillation. Keep the length of leads and traces that connect capacitors between the LM4940's power supply pin and ground as short as possible. Connecting a 10μF capacitor, C_{BYPASS} , between the BYPASS pin and ground improves the internal bias voltage's stability and improves the amplifier's PSRR. The PSRR improvements increase as the bypass pin capacitor value increases. Too large, however, increases turn-on time and can compromise the amplifier's click and pop performance. The selection of bypass capacitor values, especially C_{BYPASS} , depends on desired PSRR requirements, click and pop performance (as explained in the section, **SELECTING EXTERNAL COMPONENTS**), system cost, and size constraints.

MICRO-POWER SHUTDOWN

The LM4940 features an active-low shutdown mode that disables the amplifier's bias circuitry, reducing the supply current to 40μA (typ). Connect SHUTDOWN to a voltage between 2V to $V_{DD}/2$ for normal operation. Connect SHUTDOWN to GND to disable the device. A voltage that is greater than GND can increase shutdown current.

SELECTING EXTERNAL COMPONENTS

Input Capacitor Value Selection

Two quantities determine the value of the input coupling capacitor: the lowest audio frequency that requires amplification and desired output transient suppression.

As shown in [Figure 26](#), the input resistor (R_{IN}) and the input capacitor (C_{IN}) produce a high pass filter cutoff frequency that is found using [Equation 5](#).

$$f_c = 1/2\pi R_i C_i \quad (5)$$

As an example when using a speaker with a low frequency limit of 50Hz, C_i , using [Equation 5](#) is 0.159 μ F. The 0.39 μ F C_{INA} shown in [Figure 26](#) allows the LM4940 to drive high efficiency, full range speaker whose response extends below 30Hz.

Output Coupling Capacitor Value Selection

The capacitors C_{OUTA} and C_{OUTB} that block the $V_{DD}/2$ output DC bias voltage and couple the output AC signal to the amplifier loads also determine low frequency response. These capacitors, combined with their respective loads create a highpass filter cutoff frequency. The frequency is also given by [Equation 5](#).

Using the same conditions as above, with a 4 Ω speaker, C_{OUT} is 820 μ F (nearest common value).

Bypass Capacitor Value

Besides minimizing the input capacitor size, careful consideration should be paid to value of C_{BYPASS} , the capacitor connected to the BYPASS pin. Since C_{BYPASS} determines how fast the LM4940 settles to quiescent operation, its value is critical when minimizing turn-on pops. The slower the LM4940's outputs ramp to their quiescent DC voltage (nominally $V_{DD}/2$), the smaller the turn-on pop. Choosing C_{BYPASS} equal to 10 μ F along with a small value of C_{IN} (in the range of 0.1 μ F to 0.39 μ F), produces a click-less and pop-less shutdown function. As discussed above, choosing C_{IN} no larger than necessary for the desired bandwidth helps minimize clicks and pops.

OPTIMIZING CLICK AND POP REDUCTION PERFORMANCE

The LM4940 contains circuitry that eliminates turn-on and shutdown transients ("clicks and pops"). For this discussion, turn-on refers to either applying the power supply voltage or when the micro-power shutdown mode is deactivated.

As the $V_{DD}/2$ voltage present at the BYPASS pin ramps to its final value, the LM4940's internal amplifiers are configured as unity gain buffers and are disconnected from the AMP_A and AMP_B pins. An internal current source charges the capacitor connected between the BYPASS pin and GND in a controlled manner. Ideally, the input and outputs track the voltage applied to the BYPASS pin. The gain of the internal amplifiers remains unity until the voltage applied to the BYPASS pin.

The gain of the internal amplifiers remains unity until the voltage on the bypass pin reaches $V_{DD}/2$. As soon as the voltage on the bypass pin is stable, the device becomes fully operational and the amplifier outputs are reconnected to their respective output pins. Although the BYPASS pin current cannot be modified, changing the size of C_{BYPASS} alters the device's turn-on time. Here are some typical turn-on times for various values of C_{BYPASS} :

C_B (μ F)	T_{ON} (ms)
1.0	120
2.2	120
4.7	200
10	440

In order to eliminate "clicks and pops", all capacitors must be discharged before turn-on. Rapidly switching V_{DD} may not allow the capacitors to fully discharge, which may cause "clicks and pops".

There is a relationship between the value of C_{IN} and C_{BYPASS} that ensures minimum output transient when power is applied or the shutdown mode is deactivated. Best performance is achieved by setting the time constant created by C_{IN} and $R_i + R_f$ to a value less than the turn-on time for a given value of C_{BYPASS} as shown in the table above.

AUDIO POWER AMPLIFIER DESIGN

Audio Amplifier Design: Driving 3W into a 4Ω load

The following are the desired operational parameters:

Power Output	$3W_{RMS}$
Load Impedance	4Ω
Input Level	$0.3V_{RMS}$ (max)
Input Impedance	20kΩ
Bandwidth	100Hz–20kHz ± 0.25dB

The design begins by specifying the minimum supply voltage necessary to obtain the specified output power. One way to find the minimum supply voltage is to use the Output Power vs Power Supply Voltage curve in the [TYPICAL PERFORMANCE CHARACTERISTICS](#) section. Another way, using [Equation 6](#), is to calculate the peak output voltage necessary to achieve the desired output power for a given load impedance. To account for the amplifier's dropout voltage, two additional voltages, based on the Clipping Dropout Voltage vs Power Supply Voltage in the [TYPICAL PERFORMANCE CHARACTERISTICS](#) curves, must be added to the result obtained by [Equation 6](#). The result is [Equation 7](#).

$$V_{opeak} = \sqrt{(2R_L P_O)} \quad (6)$$

$$V_{DD} = V_{OUTPEAK} + V_{ODTOP} + V_{ODBOT} \quad (7)$$

The [Figure 13](#) graph for an 8Ω load indicates a minimum supply voltage of 11.8V. The commonly used 12V supply voltage easily meets this. The additional voltage creates the benefit of headroom, allowing the LM4940 to produce an output power of 3W without clipping or other audible distortion. The choice of supply voltage must also not create a situation that violates the maximum power dissipation as explained above in the [POWER DISSIPATION](#) section. After satisfying the LM4940's power dissipation requirements, the minimum differential gain needed to achieve 3W dissipation in a 4Ω BTL load is found using [Equation 8](#).

$$A_V \geq \sqrt{(P_O R_L)} / (V_{IN}) = V_{orms} / V_{inrms} \quad (8)$$

Thus, a minimum gain of 11.6 allows the LM4940's to reach full output swing and maintain low noise and THD+N performance. For this example, let $A_V = 12$. The amplifier's overall BTL gain is set using the input (R_{IN_A}) and feedback (R) resistors of the first amplifier in the series BTL configuration. Additionally, A_{V-BTL} is twice the gain set by the first amplifier's R_{IN} and R_f . With the desired input impedance set at 20kΩ, the feedback resistor is found using [Equation 9](#).

$$R_f / R_{IN} = A_V \quad (9)$$

The value of R_f is 240kΩ. The nominal output power is 3W.

The last step in this design example is setting the amplifier's -3dB frequency bandwidth. To achieve the desired $\pm 0.25\text{dB}$ pass band magnitude variation limit, the low frequency response must extend to at least one-fifth the lower bandwidth limit and the high frequency response must extend to at least five times the upper bandwidth limit. The gain variation for both response limits is 0.17dB, well within the $\pm 0.25\text{dB}$ -desired limit. The results are an

$$f_L = 100\text{Hz} / 5 = 20\text{Hz} \quad (10)$$

and

$$f_H = 20\text{kHz} \times 5 = 100\text{kHz} \quad (11)$$

As mentioned in the [SELECTING EXTERNAL COMPONENTS](#) section, R_{INA} and C_{INA} , as well as C_{OUT} and R_L , create a highpass filter that sets the amplifier's lower bandpass frequency limit. Find the coupling capacitor's value using [Equation 14](#).

$$C_{\text{IN}} = 1 / 2\pi R_{\text{IN}} f_L \quad (12)$$

The result is

$$1 / (2\pi \times 20\text{k}\Omega \times 20\text{Hz}) = 0.398\mu\text{F} = C_{\text{IN}} \quad (13)$$

and

$$1 / (2\pi \times 4\Omega \times 20\text{Hz}) = 1989\mu\text{F} = C_{\text{OUT}} \quad (14)$$

Use a 0.39 μF capacitor for C_{IN} and a 2000 μF capacitor for C_{OUT} , the closest standard values.

The product of the desired high frequency cutoff (100kHz in this example) and the differential gain A_V , determines the upper passband response limit. With $A_V = 12$ and $f_H = 100\text{kHz}$, the closed-loop gain bandwidth product (GBWP) is 1.2mHz. This is less than the LM4940's 3.5MHz GBWP. With this margin, the amplifier can be used in designs that require more differential gain while avoiding performance restricting bandwidth limitations.

RECOMMENDED PRINTED CIRCUIT BOARD LAYOUT

[Figure 27](#) through [Figure 29](#) show the recommended two-layer PC board layout that is optimized for the DDPACK-packaged LM4940 and associated external components. This circuit board is designed for use with an external 12V supply and 4 Ω (min) speakers.

This circuit board is easy to use. Apply 12V and ground to the board's V_{DD} and GND pads, respectively. Connect a speaker between the board's OUT_A and OUT_B outputs and their respective GND terminals.

Demonstration Board Layout

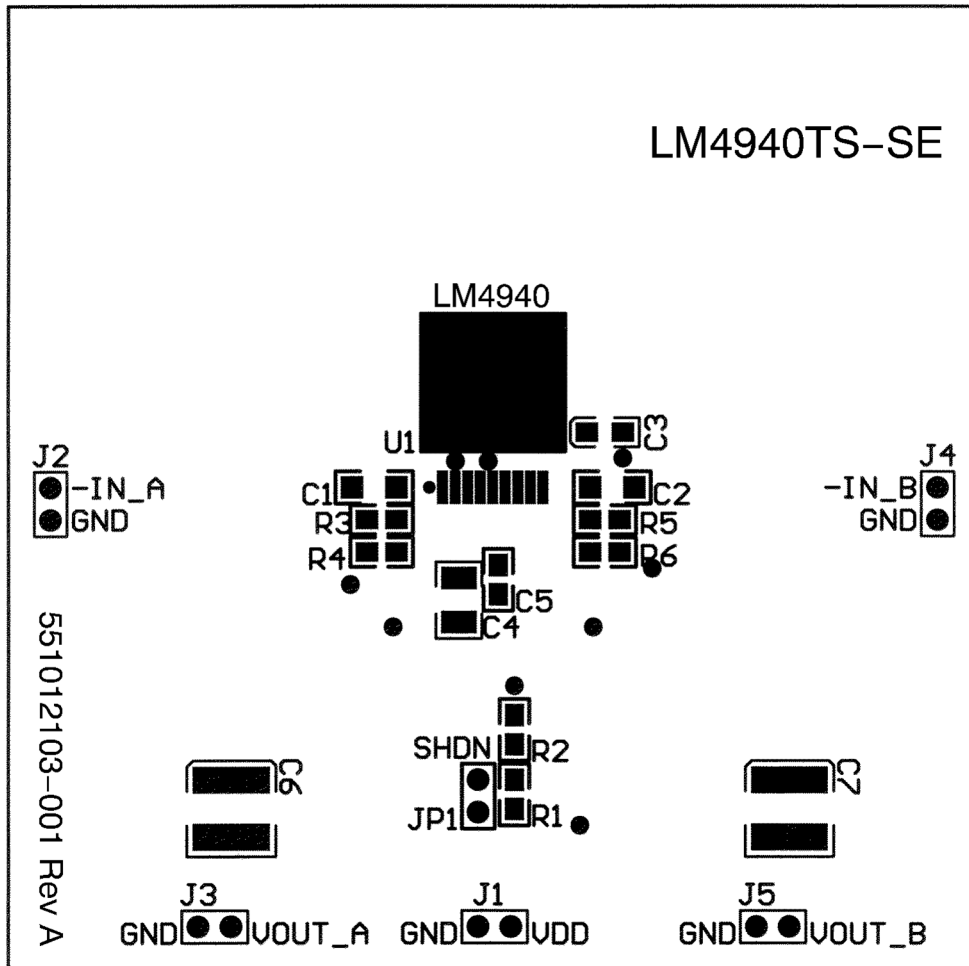
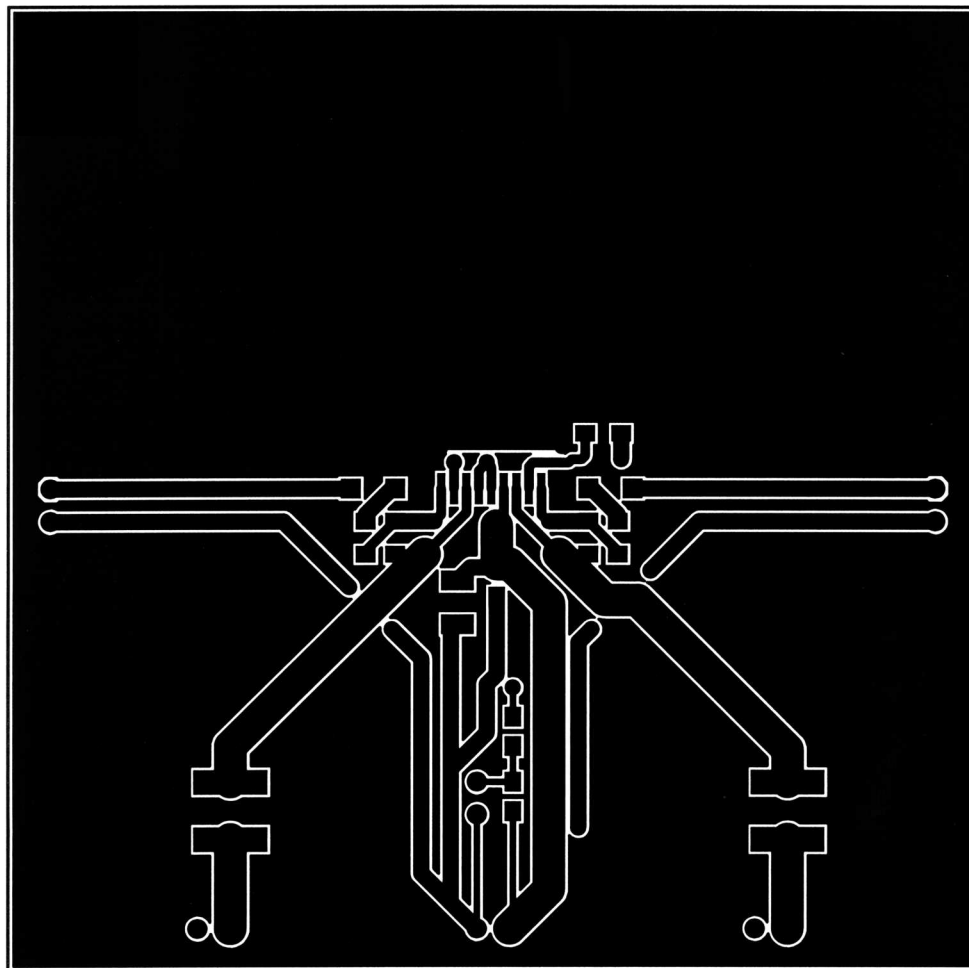

Figure 27. Recommended KTW PCB Layout:
Top Silkscreen



**Figure 28. Recommended KTW PCB Layout:
Top Layer**

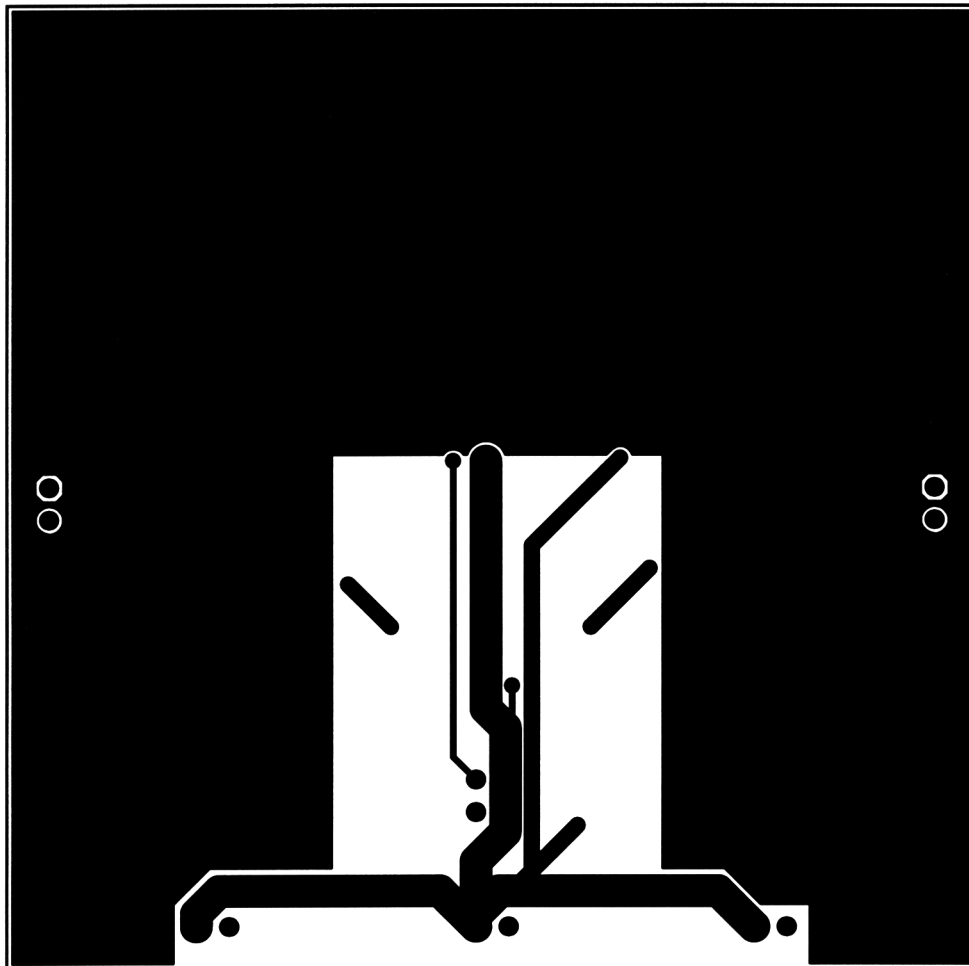

Figure 29. Recommended KTW PCB Layout:
Bottom Layer

REVISION HISTORY

Changes from Revision B (May 2013) to Revision C	Page
• Changed layout of National Data Sheet to TI format	17

PACKAGING INFORMATION

Orderable Device	Status (1)	Package Type	Package Drawing	Pins	Package Qty	Eco Plan (2)	Lead/Ball Finish (6)	MSL Peak Temp (3)	Op Temp (°C)	Device Marking (4/5)	Samples
LM4940TS/NOPB	ACTIVE	DDPAK/ TO-263	KTW	9	45	Green (RoHS & no Sb/Br)	SN	Level-3-245C-168 HR	-40 to 85	L4940TS	Samples
LM4940TSX/NOPB	ACTIVE	DDPAK/ TO-263	KTW	9	500	Green (RoHS & no Sb/Br)	SN	Level-3-245C-168 HR	-40 to 85	L4940TS	Samples

(1) The marketing status values are defined as follows:

ACTIVE: Product device recommended for new designs.

LIFEBUY: TI has announced that the device will be discontinued, and a lifetime-buy period is in effect.

NRND: Not recommended for new designs. Device is in production to support existing customers, but TI does not recommend using this part in a new design.

PREVIEW: Device has been announced but is not in production. Samples may or may not be available.

OBSELETE: TI has discontinued the production of the device.

(2) **RoHS:** TI defines "RoHS" to mean semiconductor products that are compliant with the current EU RoHS requirements for all 10 RoHS substances, including the requirement that RoHS substance do not exceed 0.1% by weight in homogeneous materials. Where designed to be soldered at high temperatures, "RoHS" products are suitable for use in specified lead-free processes. TI may reference these types of products as "Pb-Free".

RoHS Exempt: TI defines "RoHS Exempt" to mean products that contain lead but are compliant with EU RoHS pursuant to a specific EU RoHS exemption.

Green: TI defines "Green" to mean the content of Chlorine (Cl) and Bromine (Br) based flame retardants meet JS709B low halogen requirements of <=1000ppm threshold. Antimony trioxide based flame retardants must also meet the <=1000ppm threshold requirement.

(3) MSL, Peak Temp. - The Moisture Sensitivity Level rating according to the JEDEC industry standard classifications, and peak solder temperature.

(4) There may be additional marking, which relates to the logo, the lot trace code information, or the environmental category on the device.

(5) Multiple Device Markings will be inside parentheses. Only one Device Marking contained in parentheses and separated by a "~" will appear on a device. If a line is indented then it is a continuation of the previous line and the two combined represent the entire Device Marking for that device.

(6) Lead/Ball Finish - Orderable Devices may have multiple material finish options. Finish options are separated by a vertical ruled line. Lead/Ball Finish values may wrap to two lines if the finish value exceeds the maximum column width.

Important Information and Disclaimer:The information provided on this page represents TI's knowledge and belief as of the date that it is provided. TI bases its knowledge and belief on information provided by third parties, and makes no representation or warranty as to the accuracy of such information. Efforts are underway to better integrate information from third parties. TI has taken and continues to take reasonable steps to provide representative and accurate information but may not have conducted destructive testing or chemical analysis on incoming materials and chemicals. TI and TI suppliers consider certain information to be proprietary, and thus CAS numbers and other limited information may not be available for release.

In no event shall TI's liability arising out of such information exceed the total purchase price of the TI part(s) at issue in this document sold by TI to Customer on an annual basis.

TAPE AND REEL INFORMATION

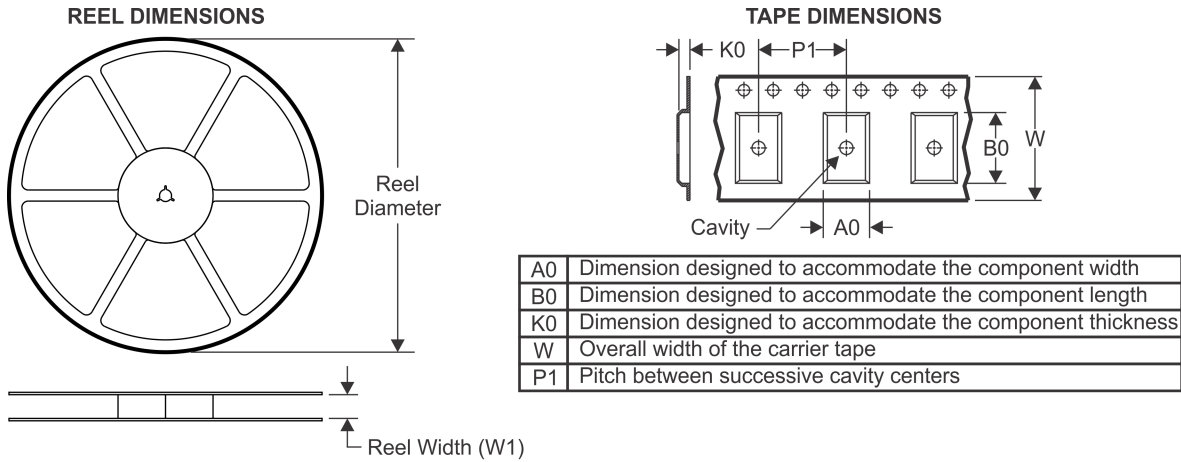

QUADRANT ASSIGNMENTS FOR PIN 1 ORIENTATION IN TAPE



*All dimensions are nominal

Device	Package Type	Package Drawing	Pins	SPQ	Reel Diameter (mm)	Reel Width W1 (mm)	A0 (mm)	B0 (mm)	K0 (mm)	P1 (mm)	W (mm)	Pin1 Quadrant
LM4940TSX/NOPB	DDPAK/TO-263	KTW	9	500	330.0	24.4	10.75	14.85	5.0	16.0	24.0	Q2

TAPE AND REEL BOX DIMENSIONS



*All dimensions are nominal

Device	Package Type	Package Drawing	Pins	SPQ	Length (mm)	Width (mm)	Height (mm)
LM4940TSX/NOPB	DDPAK/TO-263	KTW	9	500	367.0	367.0	45.0

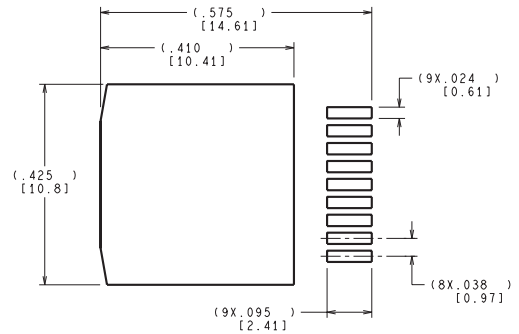
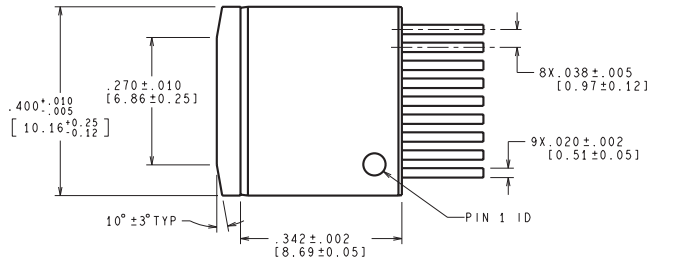
KTW0009A

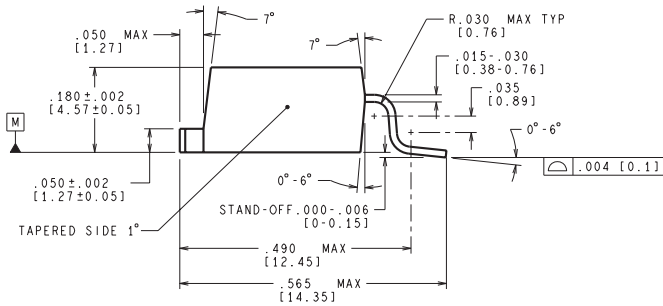

RECOMMENDED LAND PATTERN



CONTROLLING DIMENSION: INCH
DIMENSIONS IN () ARE MILLIMETERS

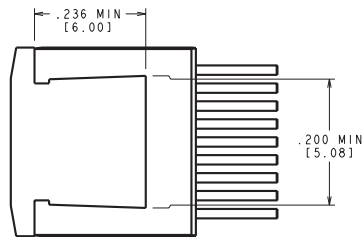

BOTTOM SIDE OF PACKAGE

TS9A (Rev B)

IMPORTANT NOTICE AND DISCLAIMER

TI PROVIDES TECHNICAL AND RELIABILITY DATA (INCLUDING DATASHEETS), DESIGN RESOURCES (INCLUDING REFERENCE DESIGNS), APPLICATION OR OTHER DESIGN ADVICE, WEB TOOLS, SAFETY INFORMATION, AND OTHER RESOURCES "AS IS" AND WITH ALL FAULTS, AND DISCLAIMS ALL WARRANTIES, EXPRESS AND IMPLIED, INCLUDING WITHOUT LIMITATION ANY IMPLIED WARRANTIES OF MERCHANTABILITY, FITNESS FOR A PARTICULAR PURPOSE OR NON-INFRINGEMENT OF THIRD PARTY INTELLECTUAL PROPERTY RIGHTS.

These resources are intended for skilled developers designing with TI products. You are solely responsible for (1) selecting the appropriate TI products for your application, (2) designing, validating and testing your application, and (3) ensuring your application meets applicable standards, and any other safety, security, or other requirements. These resources are subject to change without notice. TI grants you permission to use these resources only for development of an application that uses the TI products described in the resource. Other reproduction and display of these resources is prohibited. No license is granted to any other TI intellectual property right or to any third party intellectual property right. TI disclaims responsibility for, and you will fully indemnify TI and its representatives against, any claims, damages, costs, losses, and liabilities arising out of your use of these resources.

TI's products are provided subject to TI's Terms of Sale (www.ti.com/legal/termsofsale.html) or other applicable terms available either on ti.com or provided in conjunction with such TI products. TI's provision of these resources does not expand or otherwise alter TI's applicable warranties or warranty disclaimers for TI products.

Mailing Address: Texas Instruments, Post Office Box 655303, Dallas, Texas 75265
Copyright © 2020, Texas Instruments Incorporated