STEVAL-USBPD45C 45 W USB Type-C™ Power Delivery adapter

Introduction

The [STEVAL-USBPD45C](#) reference design is a 45 W AC-DC adapter featuring a USB Type-C connector functioning as a USB Power Delivery provider with single source port. It accepts a wide input mains range (90 to 264 V_{AC}) and delivers 5 V, 9 V and 15 V output voltage profiles, according to the Source Power Rules of the current USB Power Delivery specification.

The board is designed and tested in compliance with USB Type-C™ receptacle, plug and cable specification rev. 1.3 and USB Power Delivery (PD) specification rev. 3.0. The [STUSB1602A](#) USB controller and [X-CUBE-USB-PD](#) software library running on a [high performance 32-bit ARM Cortex-M0 MCU](#) are PD 3.0 certified.

To increase the efficiency of the power supply stage, synchronous rectification is implemented on the secondary side. A low R_{DS_ON} MOSFET is used instead of a diode rectifier on the output stage and it is driven directly by the microcontroller. The adaptive synchronous rectification algorithm can handle all possible load conditions for the best possible power efficiency.

The adapter has a compact and lightweight design with very high power density. It features minimum four-point average efficiency in active mode, which is compliant with CoC ver. 5 - Tier 2, and offers very low stand-by consumption at less than 35 mW.

The board is protected against destructive electrostatic discharge (ESD) from the USB Type-C connector.

1 Converter specifications and description

The STEVAL-USBPD45P uses a quasi-resonant flyback topology to convert the input AC voltage into a regulated DC output voltage. The converter operates in the following modes according to the load:

- medium or light: Valley-skipping mode
- very light or no load: Burst mode

Table 1. Converter design specifications

Specification	Value	Description
V _{in}	90 V _{AC} – 264 V _{AC}	Input voltage range
Frequency	45 – 65 Hz	Input frequency range
V _{out}	5 V/9 V/15 V	Output voltage
Power	45W	Nominal output power
Available profiles	5 V/3 A; 9 V/3 A; 15 V/3 A	PD profiles
Topology	QR Isolated Flyback	Quasi-resonant (QR) zero-voltage switching (ZVS) operation with primary side constant current (CC) output regulation
Switching frequency	Variable	From 31 to 175 kHz
Output connector	Type-C	5.5 feet captive cable with Type-C connector

The STCH03 controller is designed to achieve very low power consumption during no load operation. The quasi-resonant mode of operation is ideal for high efficiency and low EMI thanks to zero voltage switching in the main Power MOSFET. In addition, the controller provides primary side constant current (CC) control, which is set to slightly above 3 A for this specific design.

Figure 1. Power supply board primary and secondary stages

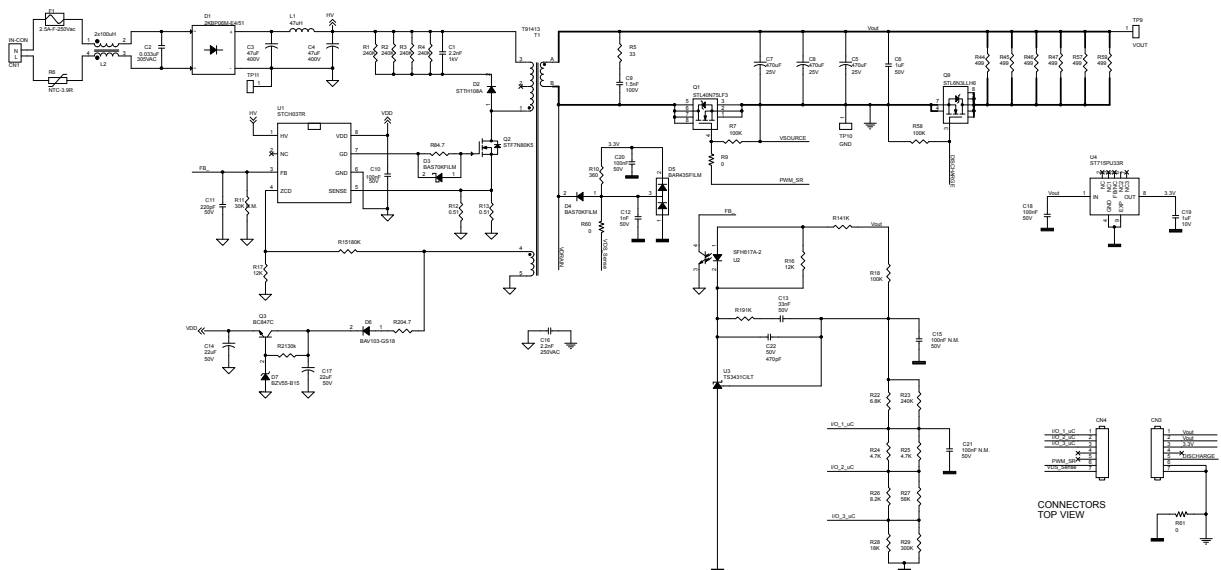

The AC input voltage is filtered by an EMI filter consisting of a common choke (L2) and differential mode capacitor (C2), which is then rectified through a 2 A, 600 V integrated diode bridge. A balanced PI filter with two 47 µF electrolytic capacitors (C3 and C4) and a 47 µH inductor (L1) improves EMI performance.

The input section of the converter has a 2.5 A fuse and a 3.9 Ω NTC for inrush current limiting at start up. The AC voltage must be connected to input connector CN1.

The STCH03 drives the gate of the 800 V STF7N80K5 power MOSFET (Q2), which belongs to the K5 family of super-junction high voltage power MOSFETs with high breakdown voltage, very low $R_{DS(on)}$ and parasitic capacitance. The MOSFET is protected using an RCD snubber (D2, C1 R1, R2, R3, R4) to clamp the overvoltage caused by the transformer leakage inductance at turn-off to a safe value that is well below the breakdown voltage of the MOSFET.

The high frequency transformer uses an RM10 core designed according to the specifications shown in [Figure 2. RM10 core specification](#).

The regulation point is set by selecting an appropriate transformer turns ratio and current sensing resistor value (R12, R13)

The output voltage regulation circuit consists of a photocoupler, a voltage reference and an optocoupler to ensure isolation from the primary side. A 650 V integrated high voltage startup circuit starts the IC as soon as the bus voltage reaches approximately 50 V (typical).

Figure 2. RM10 core specification

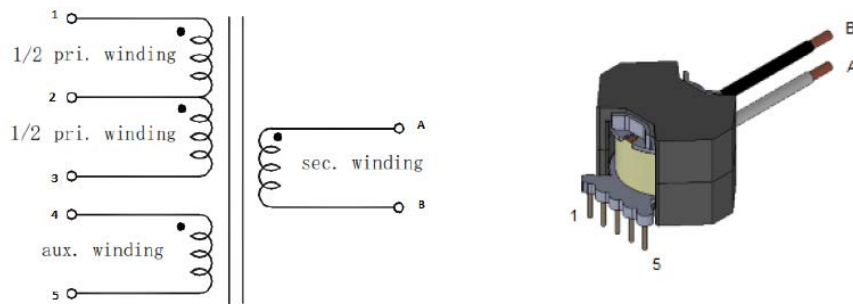

ELECTRICAL SPECIFICATIONS (at 25°C unless otherwise specified)

PARAMETER	CONDITIONS	VALUE	UNITS	TOLERANCE
Inductance (OCL)	(1-3) 0.1Vrms, 10kHz	600	μ H	\pm 15%
DCR (PRI)	(1-3)	0.38	Ω	MAX
DCR (SEC)	(A-B)	8.00	m Ω	MAX
DCR (AUX)	(4-5)	0.40	Ω	MAX
Leakage Inductance (LL)	(1-3) [tie 4+5, A+B], 0.1 Vrms, 100kHz	12.0	μ H	MAX
Turns Ratio	(1-3) : (A-B)	10.4:1	N/A	\pm 2%
Turns Ratio	(1-3) : (4-5)	5.2:1	N/A	\pm 2%
HI-POT	(1,2,3,4,5) : (A,B)	3000	Vrms	2S, 1mA, 50/60Hz

The auxiliary winding of the transformer is used to supply the controller and to provide the ON/OFF triggering signal for the main MOSFET by connecting this winding to the ZCD of the STCH03 via a voltage divider (R15, R17).

A linear regulator connects the auxiliary winding with the V_{DD} pin of the controller to ensure a stable supply voltage across all input voltage, output voltage, and load conditions.

2 Power supply typical waveforms

2.1 Startup at no load and full load conditions

The following figures show the startup of the converter at 115 V_{AC} and 230 V_{AC} input voltage under no load and full load conditions.

The output voltage reaches the regulation value of 5 V about 80 ms after the application of the AC voltage to the input connector.

Startup at 115 V input

Figure 3. startup; V_{IN} = 115 V_{AC}/60 Hz, no load

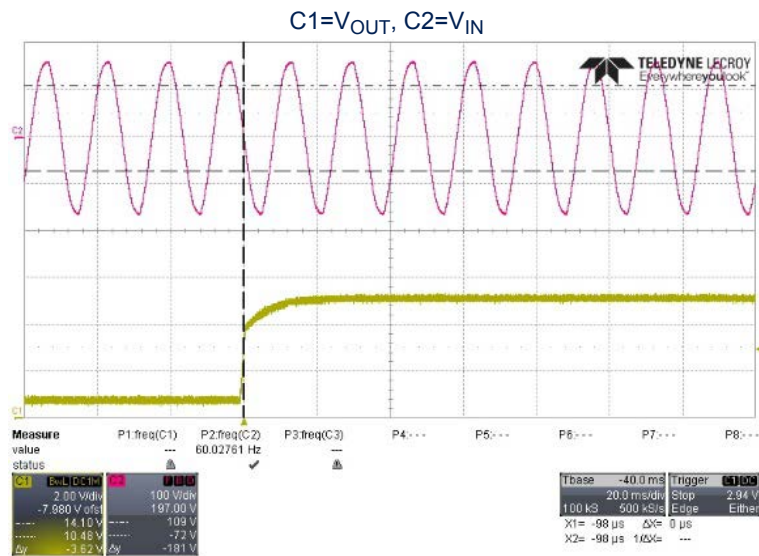
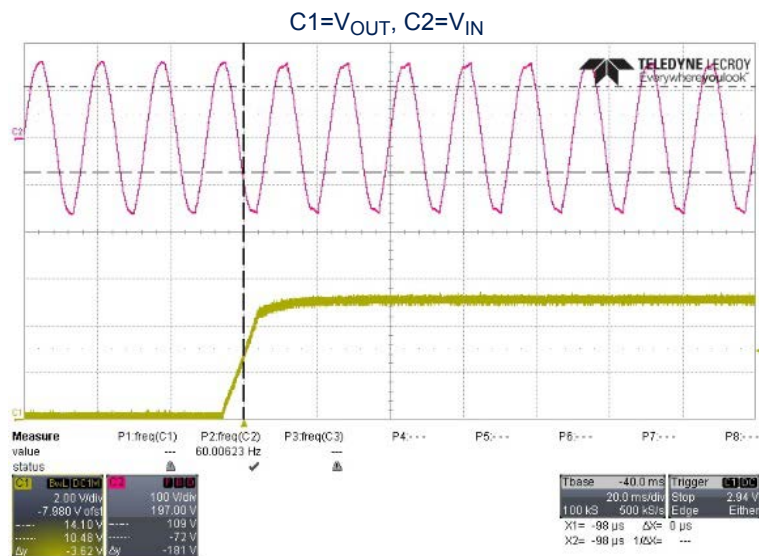
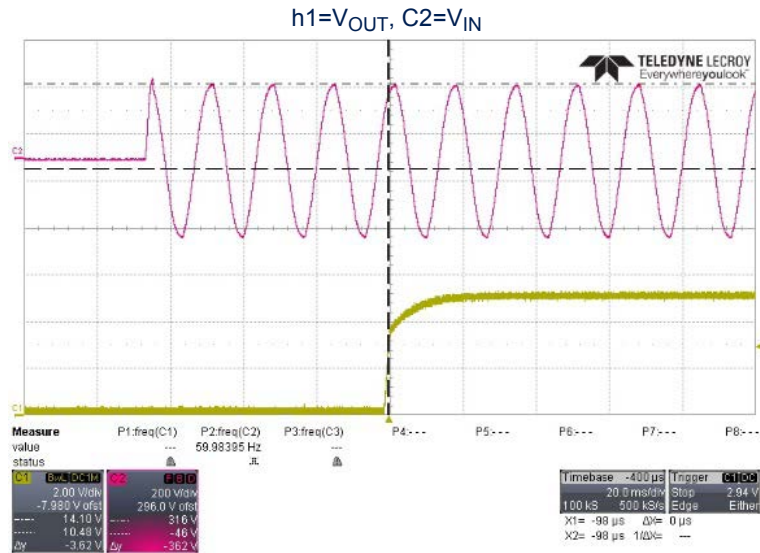
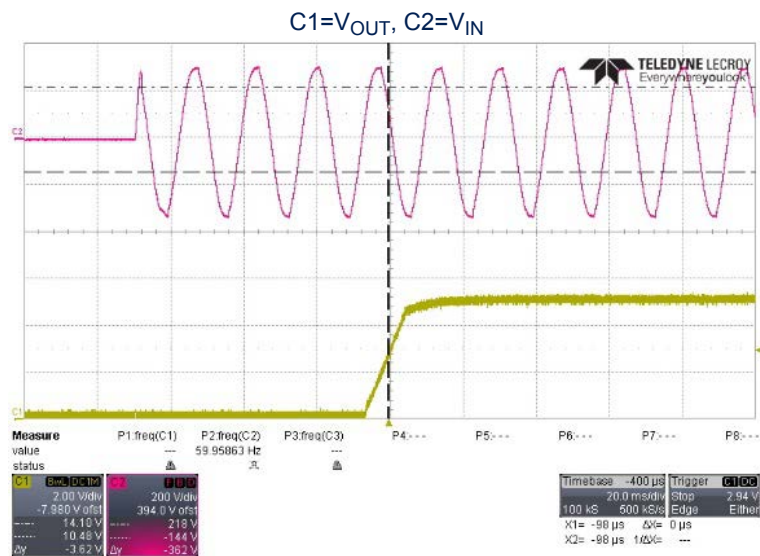

Figure 4. startup; V_{IN} = 115 V_{AC}/60 Hz, I_{OUT} = 3 A



Startup at 230 V input
Figure 5. startup; $V_{IN} = 230 V_{AC}/50 Hz$, no load

Figure 6. startup; $V_{IN} = 230 V_{AC}/50 Hz$, $I_{OUT} = 3 A$

2.2 Output voltage regulation for dynamic load variation

The following two figures show the output voltage regulation for dynamic load variation. A 10% to 90% (and back) load variation is applied to the output of the power supply, with a 10 Hz repetition rate and 50% duty cycle.

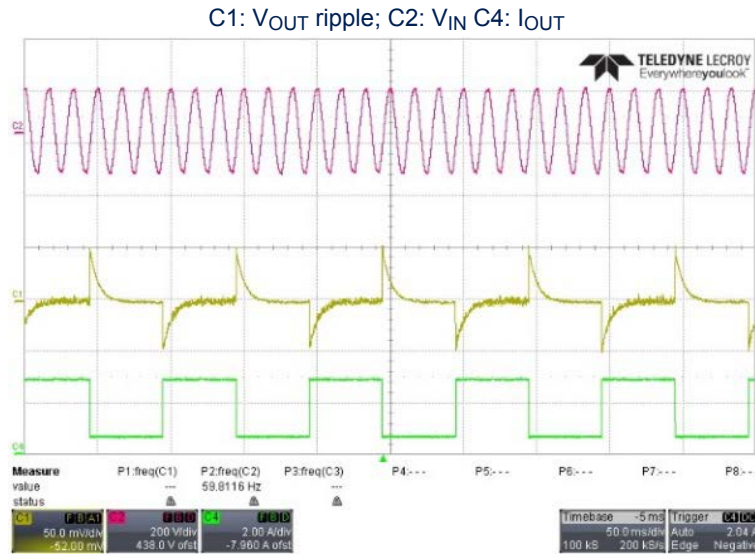
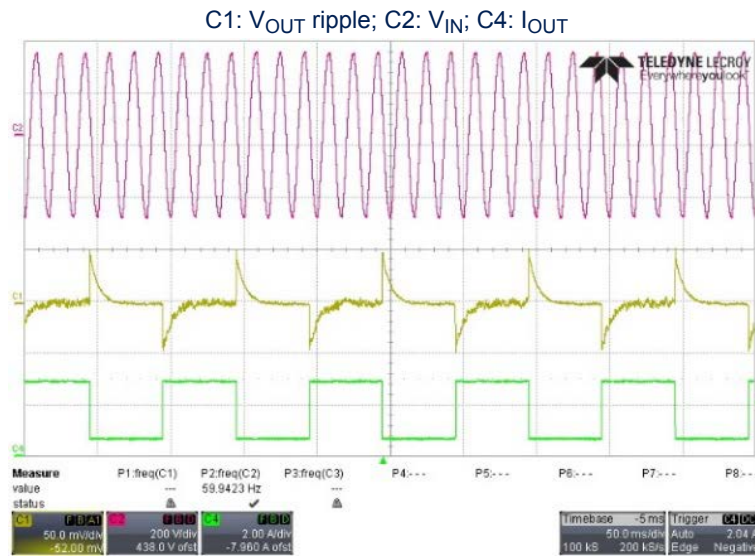
Notice the peak to peak ripple on the output voltage is less than 100 mV.

Figure 7. Output voltage; $V_{IN} = 115 V_{AC}/60 \text{ Hz}$, $I_{OUT} = 10\%-90\%$, $1 A/\mu s$

Figure 8. output voltage; $V_{IN} = 230 V_{AC}/50 \text{ Hz}$, $I_{OUT} = 10\%-90\%$, $1 A/\mu s$

2.3 Voltage stress on the main power MOSFET at full load

The following two figures show the voltage stress on the main power MOSFET at full load when the converter is supplied minimum and maximum AC input voltages.

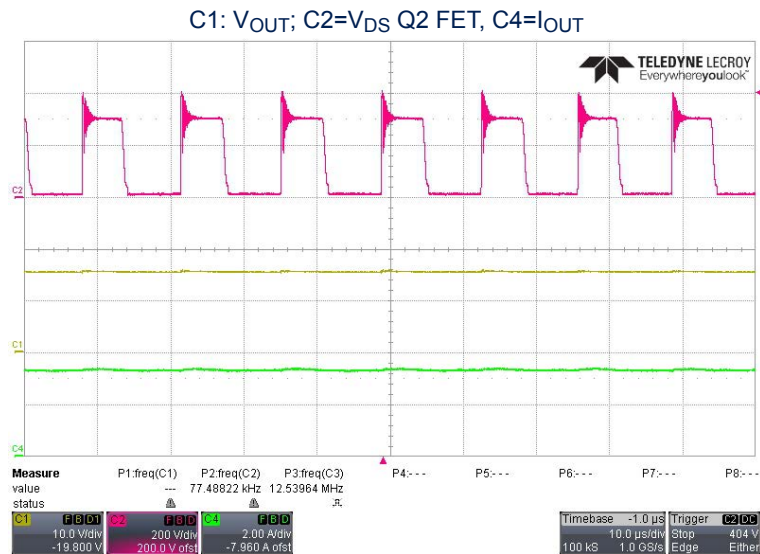
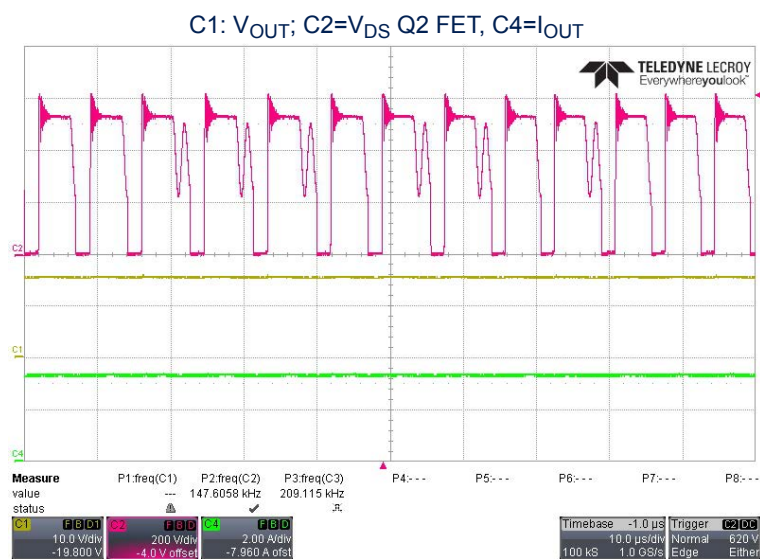
At $90 V_{AC}$, the peak drain to source voltage is $404 V$, while at $264 V_{AC}$, the peak is $620 V$. These are well below the $800 V$ breakdown voltage of the MOSFET, with more than 20% margin.

Figure 9. Voltage on power MOSFET; $V_{IN} = 90 V_{AC}/60 \text{ Hz}$, $V_{OUT} = 15 \text{ V}$, $I_{OUT} = 3 \text{ A}$, $V_{DS_max} = 404 \text{ V}$

Figure 10. Voltage on power MOSFET; $V_{IN} = 264 V_{AC}/50 \text{ Hz}$, $V_{OUT} = 15 \text{ V}$, $I_{OUT} = 3 \text{ A}$, $V_{DS_max} = 620 \text{ V}$

2.4 Short-circuit conditions

The adapter was also tested to verify safe operation in case of output short-circuit. The STCH03 has embedded protections against short-circuits on the secondary rectifier, short-circuits on the secondary winding or a hard-saturated flyback transformer.

The following two figures show the operation of the power supply when the output connector is shorted while the power supply is operating at full power and maximum input voltage. As soon as the overload condition is detected, the gate of the MOSFET is turned off and the power supply enters hiccup mode to avoid overheating the power components during this condition.

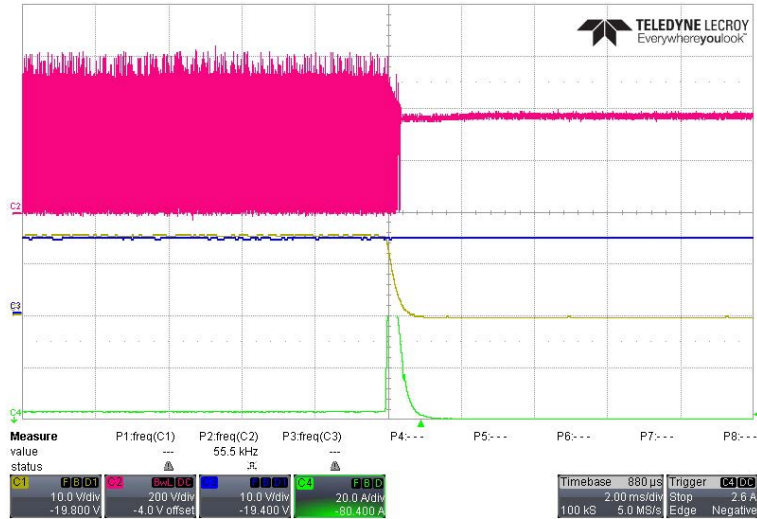
Figure 11. Short-circuit; 264 V_{AC}/50 Hz V_{OUT} = 15 V, I_{OUT} = 3 A

 C1: V_{OUT}; C2=V_{DS} Q2 FET, C3: V_{DD} pin of STCH03; C4=I_{OUT}

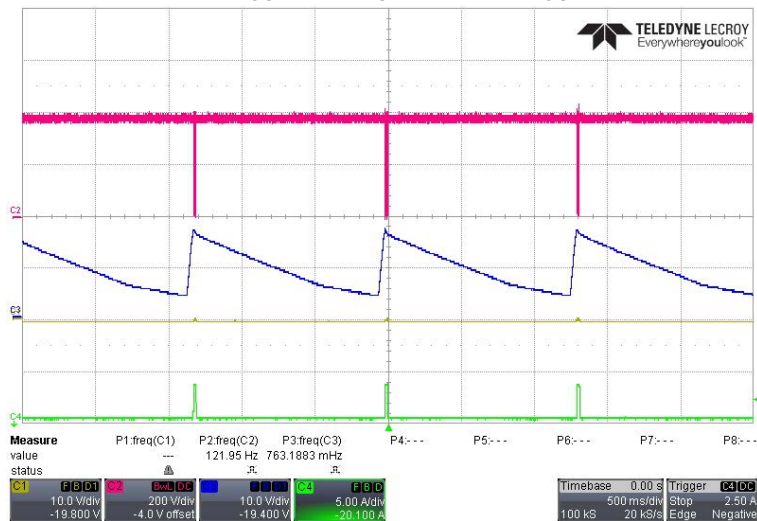
Figure 12. Short-circuit; 264 V_{AC}/50 Hz V_{OUT} = 15 V, I_{OUT} = 3 A; short-circuit and hiccup mode

 C1: V_{OUT}; C2=V_{DS} Q2 FET, C4=I_{OUT}

2.5 Adapter behavior for different power profiles

The following figures capture the output voltage under various conditions.

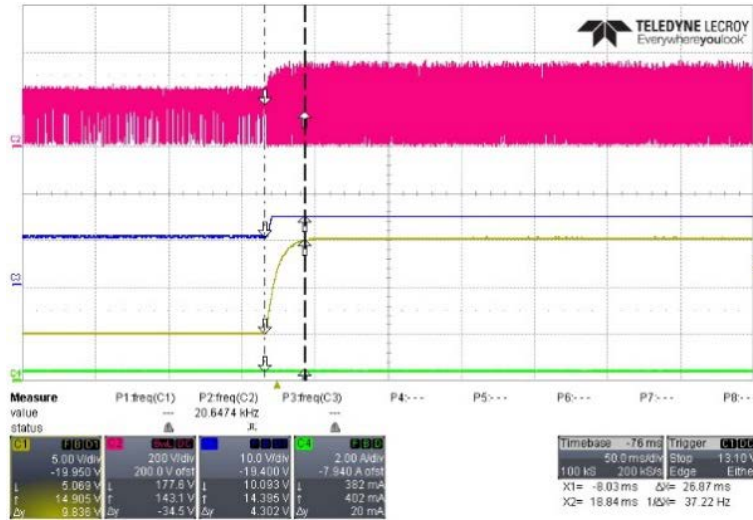
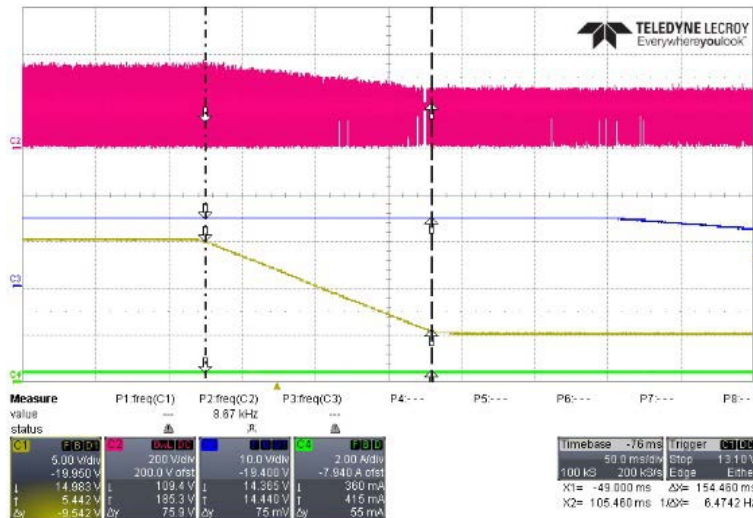
For each condition, output voltage reaches the new steady state value in less than 160 ms and the transition to the newly negotiated voltage occurs with effectively no overshoot or undershoot, remaining well inside the ± 0.5 V range of the Power Delivery specification.

Backwards and forwards transition between 5 and 15 V, 115 V input, no load
Figure 13. Dynamic behavior $V_{IN} = 115 V_{AC}/60 \text{ Hz}$ $I_{OUT} = 0 \text{ A}$, 5 V to 15 V, transition 26 ms
 $C1=V_{OUT}$, $C2=V_{DS} Q2$; $C3: V_{DD}$; $C4: I_{OUT}$

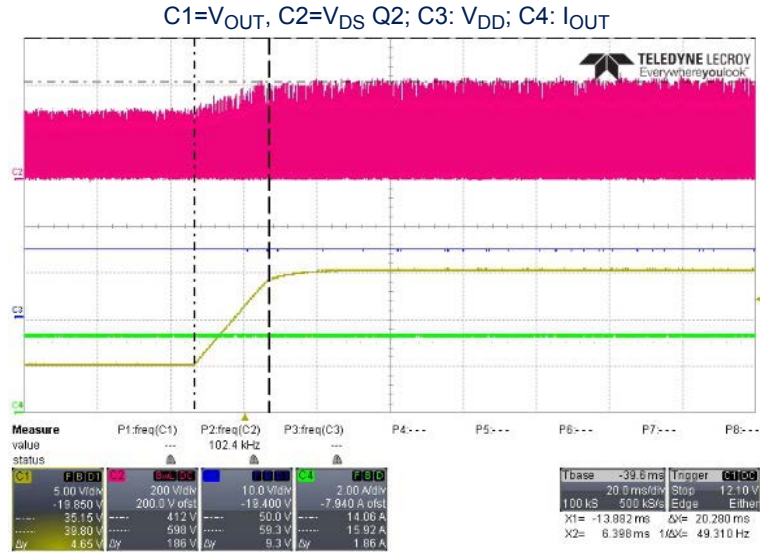
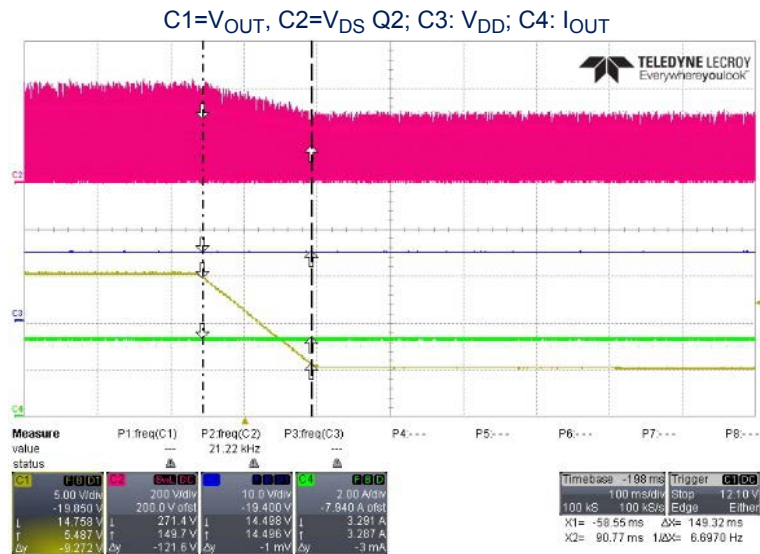
Figure 14. Dynamic behavior $V_{IN} = 115 V_{AC}/60 \text{ Hz}$ $I_{OUT} = 0 \text{ A}$, 15 V to 5 V, transition 154 ms
 $C1=V_{OUT}$, $C2=V_{DS} Q2$; $C3: V_{DD}$; $C4: I_{OUT}$

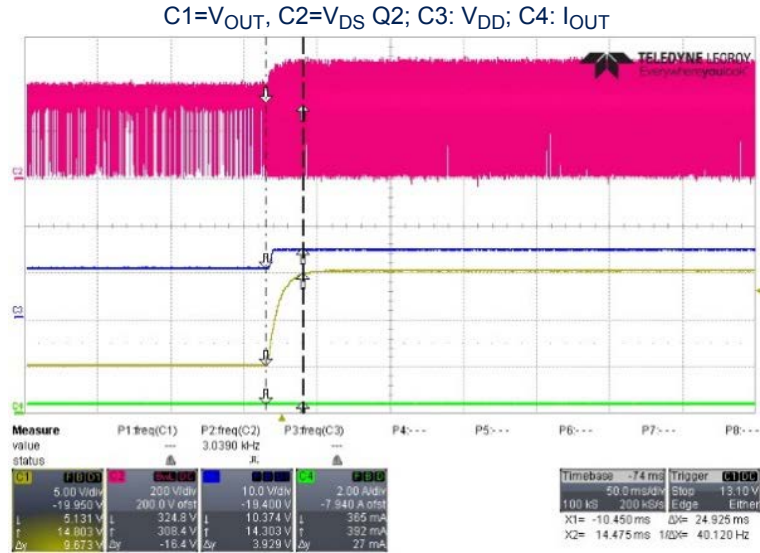
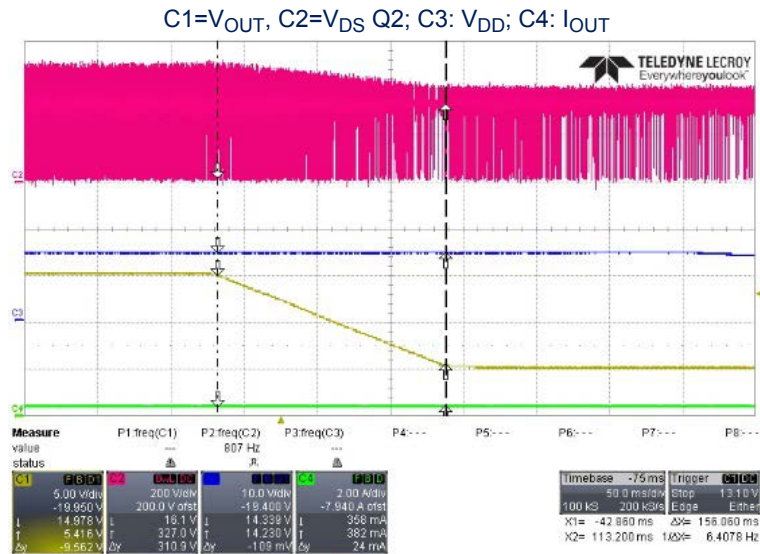
Backwards and forwards transition between 5 and 15 V, 115 V input, 3 A load
Figure 15. Dynamic behavior $V_{IN} = 115 V_{AC}/60 \text{ Hz}$ $I_{OUT} = 3 \text{ A}$, 5 V to 15 V, transition 20 ms

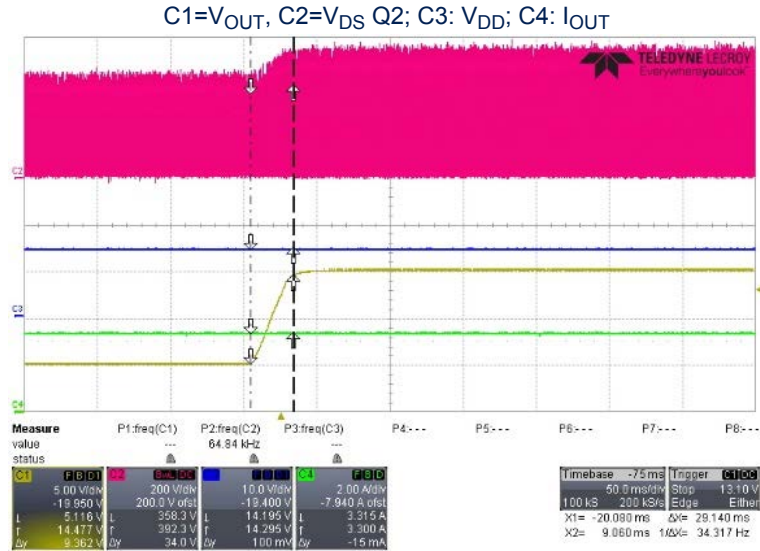
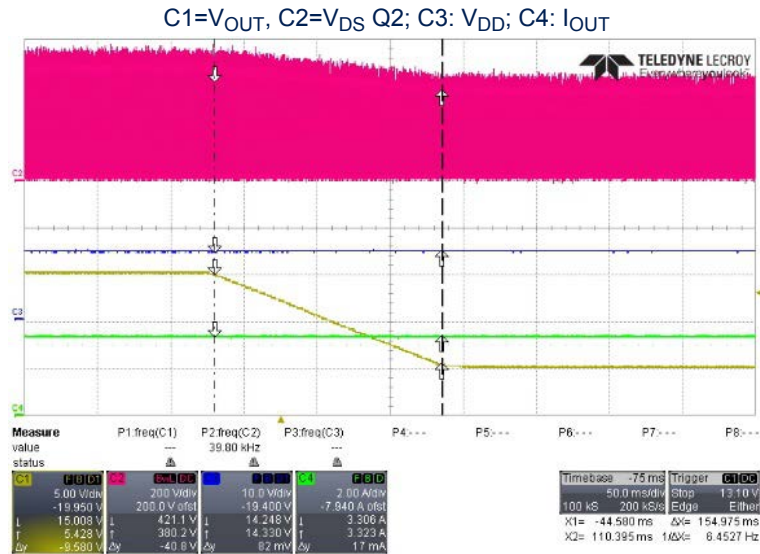
Figure 16. Dynamic behavior $V_{IN} = 115 \text{ Vac}/60 \text{ Hz}$ $I_{OUT} = 3 \text{ A}$, 15V to 5 V, transition 150 ms

Backwards and forwards transition between 5 and 15 V, 230 V input, no load
Figure 17. Dynamic behavior $V_{IN} = 230 V_{AC}/50 Hz$ $I_{OUT} = 0 A$, 5 V to 15 V, transition 25 ms

Figure 18. Dynamic behavior $V_{IN} = 230 V_{AC}/50 Hz$ $I_{OUT} = 0 A$, 15 V to 5 V, transition 156 ms

Backwards and forwards transition between 5 and 15 V, 230 V input, 3 A load
Figure 19. Dynamic behavior $V_{IN} = 230 V_{AC}/50 \text{ Hz}$ $I_{OUT} = 3 \text{ A}$, 5 V to 15 V, transition 155 ms

Figure 20. Dynamic behavior $V_{IN} = 230 V_{AC}/50 \text{ Hz}$ $I_{OUT} = 3 \text{ A}$, 15 V to 5 V, transition 155 ms

3 Synchronous rectification

The relatively high peak and rms current in flyback converters cause high conduction losses in the output diode rectifier. Synchronous rectification (SR) using the [STL40N75LF3](#) low R_{DS_ON} MOSFET instead of a diode rectifier on the output stage can reduce these losses and increase efficiency.

The MOSFET is directly driven by the [high performance 32-bit ARM Cortex-M0 MCU](#) running an SR algorithm, which is enabled when the output current rises above 0.3 A.

When the MOSFET body diode starts to conduct, the synchronous rectification control logic generates a PWM signal to turn the MOSFET on. This reduces conduction losses as the current flows through the MOSFET channel with a low resistance, instead of the internal body diode.

A sensing circuit for the V_{DS} voltage, consisting of the D4 and RC network, is required to drive the MOSFET Q1 according to current flow:

- The MOSFET is turned on when the current flows through the body diode and the V_{DS} voltage goes negative
- The MOSFET is turned off when the current falls to zero and the V_{DS} rises again.

Two internal MCU comparators are used to detect the rising and falling edges of the V_{DS} sensing signal and trigger TIM1, which generates PWM in Single-pulse mode.

The following figures show oscilloscope screens under different conditions for:

- V_{DS_SENSE} voltage (in blue)
- PWM_{SR} signal controlling the synchronous rectification (SR) MOSFET Q1 (in yellow)

[Figure 21. \$V_{DS_SENSE}\$ and \$PWM_{SR}\$ waveform examples](#) shows a single period on the secondary side. The PWM is turned on when the V_{DS_SENSE} signal presents a falling edge, meaning that the body diode of Q1 is conducting. Once the PWM is turned on, the Q1 channel is conducting with its low R_{DS_on} , thus lowering the voltage drop on the device.

Q1 is turned off when V_{DS_SENSE} reaches the threshold set to prevent damage when there is current inversion (the second notch on the waveform).

The adaptive synchronous rectification algorithm sets the appropriate turn-off events for the given load conditions.

Figure 21. V_{DS_SENSE} and PWM_{SR} waveform examples

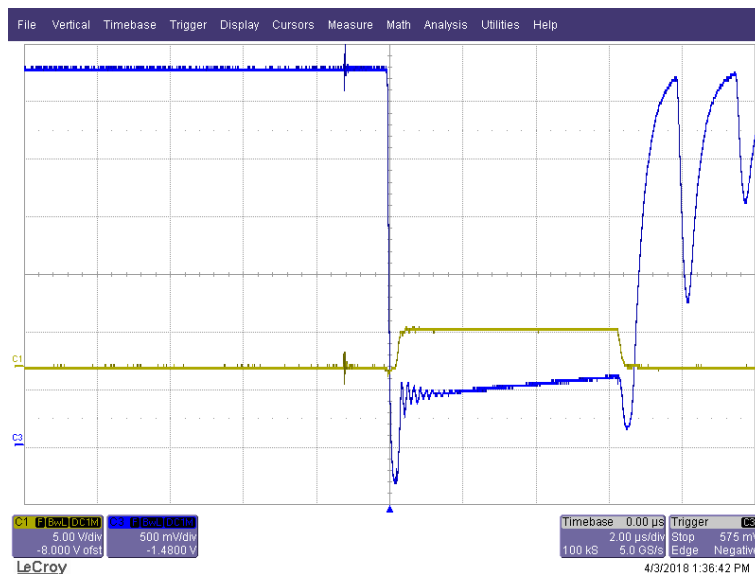

The following figures show the V_{DS_SENSE} and PWM_{SR} waveforms for the three voltages profiles (5 V, 9 V, 15 V) with a 1 A load.

Figure 22. Synchronous rectification waveforms with 5 V output

Figure 23. Synchronous rectification waveforms with 9 V output

Figure 24. Synchronous rectification waveforms with 15 V output

RELATED LINKS

[7.1 Schematics on page 24](#)

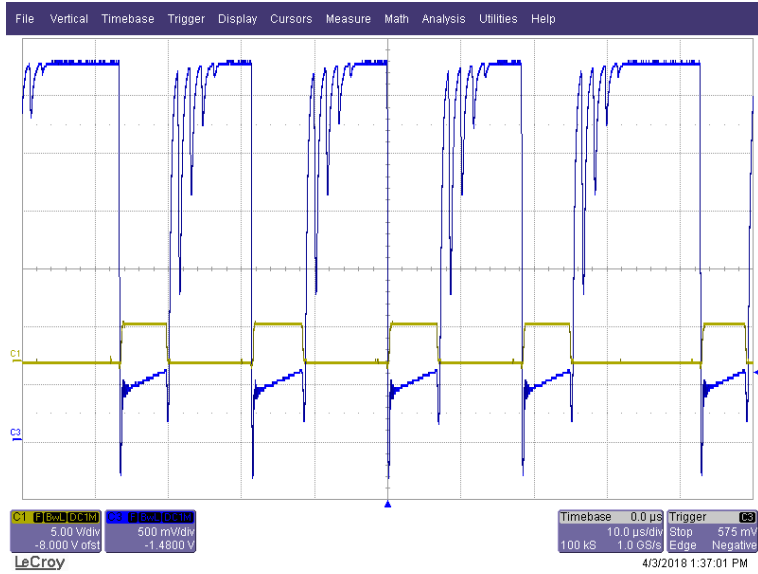
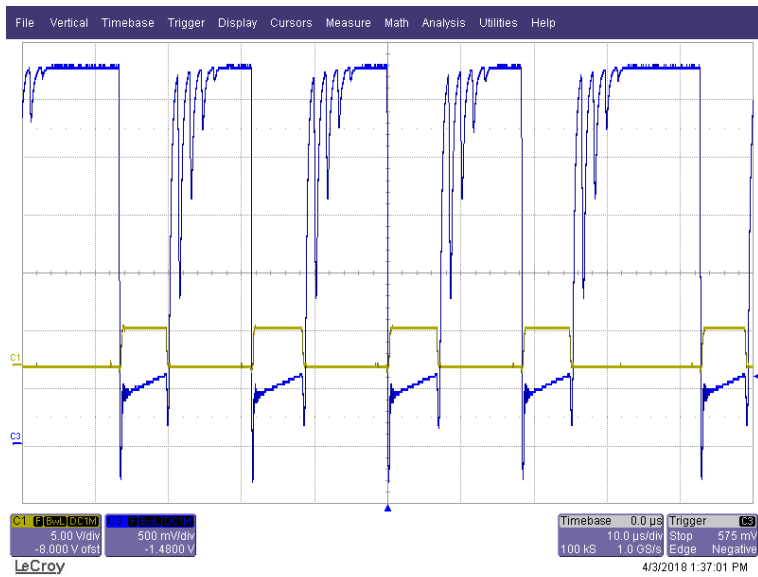
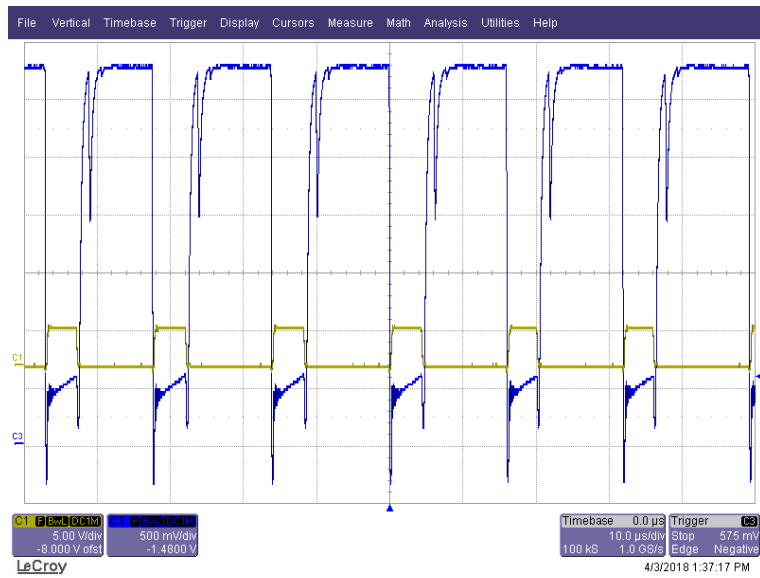
[UM2404 STEVAL-USBPD45C 45 W USB Type-C™ Power Delivery adapter](#)

4 Efficiency measurements

In this power efficiency analysis, a [P-NUCLEO-USB002](#) board is used to request the three power profiles offered by the [STEVAL-USBPD45C](#). An electronic load is connected to the P-NUCLEO connector (CN11 or CN12) to sink different current values.

Two Yokogawa WT310 digital power meters measure the power delivered to the adapter and the power flowing to the applied load. The output voltage is measured on the output of the flyback converter (on top of capacitor C6), while the current is measured on the load.

The measurements are performed with R6 NTC removed.

Table 2. Efficiency results for the 15 W power profile

V _{ACIN} [V]	P _{IN} [W]	V _{OUT} [V]	I _{OUT} [A]	P _{OUT} [W]	Efficiency [%]
115	4.39	5.18	0.744	3.85392	87.79%
115	8.78	5.18	1.500	7.77000	88.50%
115	13.62	5.28	2.290	12.09120	88.78%
115	17.84	5.28	3.000	15.84000	88.79%
230	4.57	5.18	0.749	3.87982	84.90%
230	9.01	5.18	1.500	7.77000	86.24%
230	13.83	5.28	2.290	12.09120	87.43%
230	18.04	5.28	2.990	15.78720	87.51%

Table 3. Efficiency results for the 27 W power profile

V _{ACIN} [V]	P _{IN} [W]	V _{OUT} [V]	I _{OUT} [A]	P _{OUT} [W]	Efficiency [%]
115	7.86	9.30	0.747	6.94710	88.39%
115	15.58	9.29	1.500	13.93500	89.44%
115	24.10	9.39	2.290	21.50310	89.22%
115	31.54	9.38	2.990	28.04620	88.92%
230	8.08	9.30	0.750	6.97500	86.32%
230	15.82	9.29	1.500	13.93500	88.08%
230	24.07	9.39	2.290	21.50310	89.34%
230	31.38	9.38	2.990	28.04620	89.38%

Table 4. Efficiency results for the 45 W power profile

V _{ACIN} [V]	P _{IN} [W]	V _{OUT} [V]	I _{OUT} [A]	P _{OUT} [W]	Efficiency [%]
115	13.17	15.40	0.748	11.51920	87.47%
115	25.90	15.39	1.510	23.23890	89.73%
115	39.38	15.36	2.290	35.17440	89.32%
115	51.45	15.35	3.000	46.05000	89.50%
230	13.38	15.41	0.751	11.57291	86.49%
230	26.01	15.39	1.500	23.08500	88.75%

V_{ACIN} [V]	P_{IN} [W]	V_{OUT} [V]	I_{OUT} [A]	P_{OUT} [W]	Efficiency [%]
230	39.12	15.37	2.290	35.19730	89.97%
230	50.89	15.35	2.990	45.89650	90.19%

The minimum four-point-average efficiency in active mode, summarized in the table below, is compliant with CoC - Tier 2 and DOE requirements.

Table 5. Four-point-average efficiency

V_{ACIN} [V]	P_{IN} [W]	4pt-average efficiency [%]	4pt-average min efficiency [%]	Target 4pt-average efficiency [%]
115	15	88.46%	86.52%	81.84%
230	15	86.52%		
115	27	88.99%	88.28%	87.80%
230	27	88.28%		
115	45	89.00%	88.85%	88.85%
230	45	88.85%		

4.1 Standby consumption

Following table reports stand-by consumption of the [STEVAL-USBPD45C](#). These data are acquired while the kit is supplied and no consumer is attached. The solution is compliant with CoC - Tier 2.

Table 6. Stand-by consumption

V_{ACIN} [V]	Freq [Hz]	P_{IN} [mW]	Target [mW]
115	60	<35	75
230	50	<35	

5 USBPD messages exchange and typical waveforms

The USBPD data are collected with the MQP USB-PDT tool and corresponding GraphicsUSB V5.50.05 software. The following figure shows an example of Power Delivery negotiation and how an explicit contract is reached.

Figure 25. Explicit Power Delivery contract negotiation

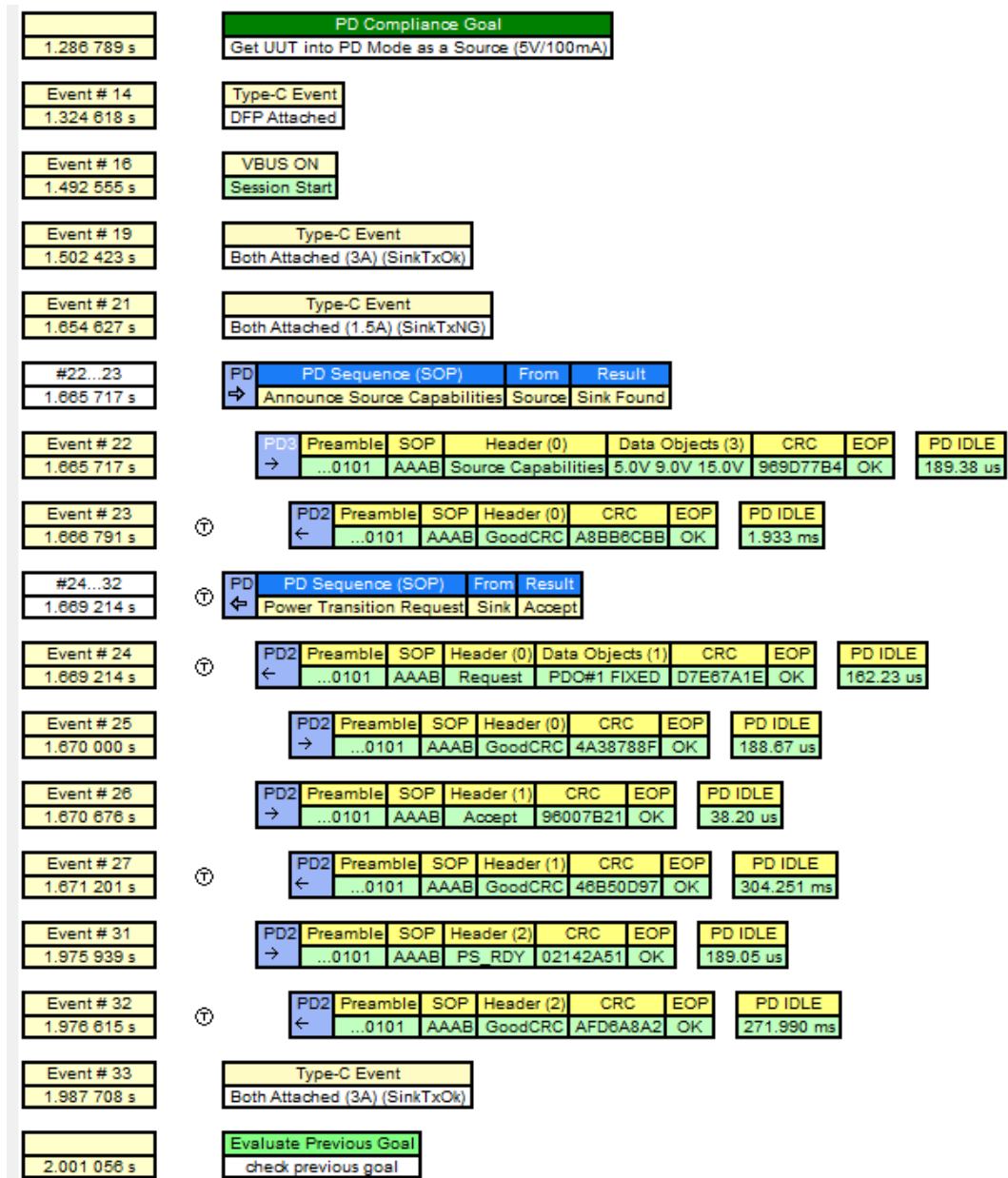
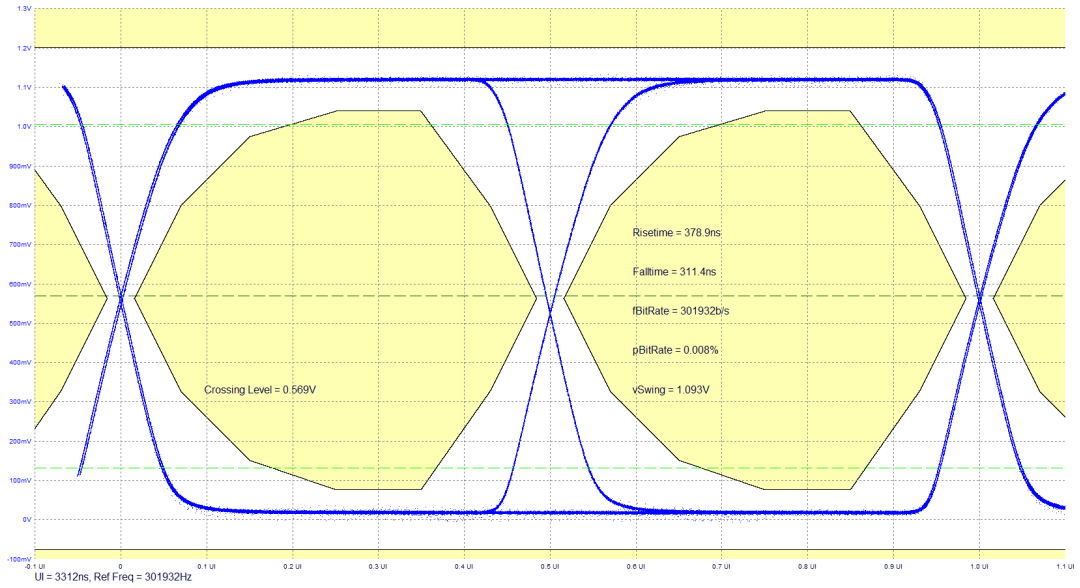

Figure 26. Eye diagram of USBPD transceiver

The following figures show the voltage transitions.

Figure 27. Transition from 5 V to 9 V

Figure 28. Transition from 5 V to 15 V

Figure 29. Transition from 9 V to 15 V

Figure 30. Transition from 5 V to 15 V

Figure 31. Transition from 15 V to 5 V

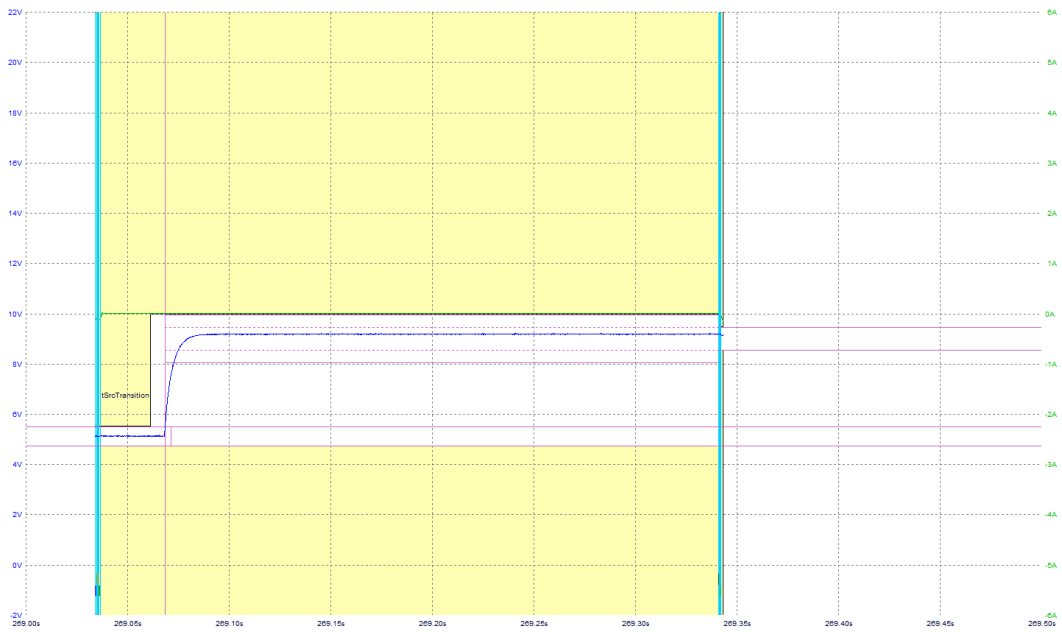
Figure 32. Transition from 15 V to 9 V

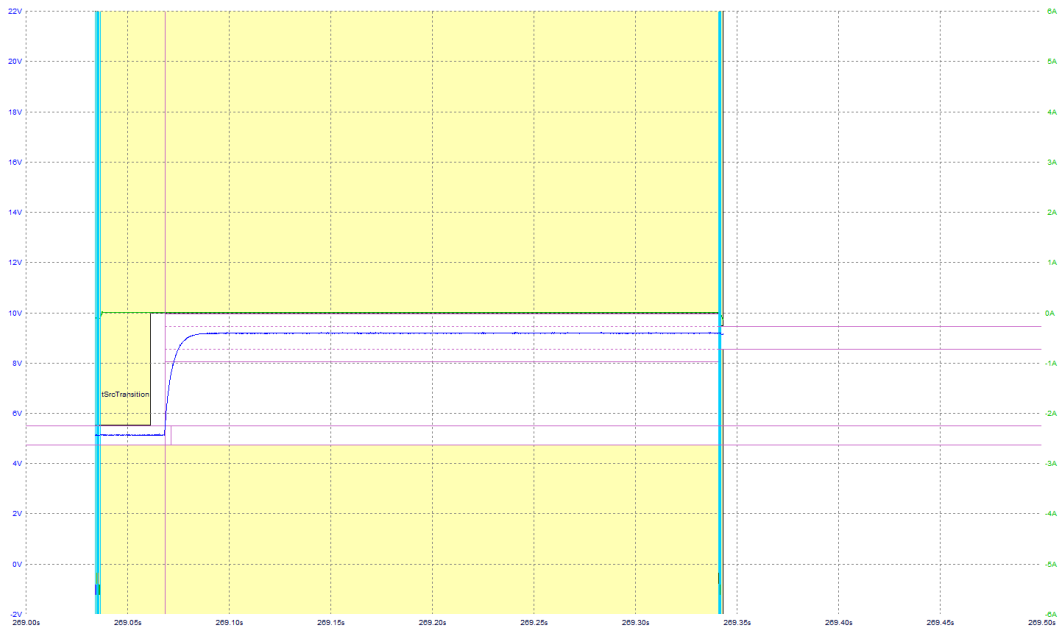
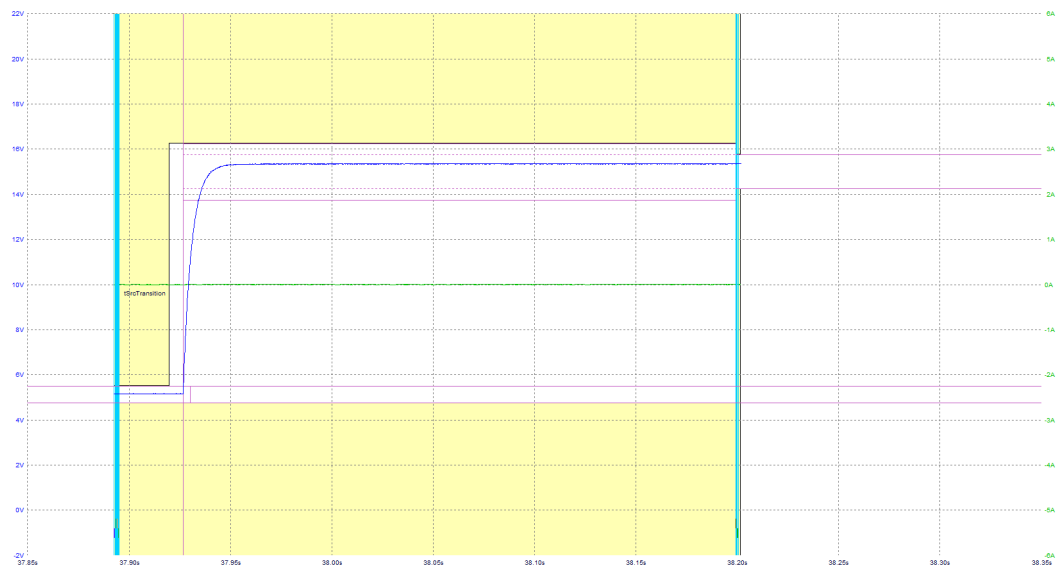
6 USB Power Delivery compliance results

All Type-C™ and Power Delivery compliance testing was performed with official USB-IF testing tools listed in the following table.

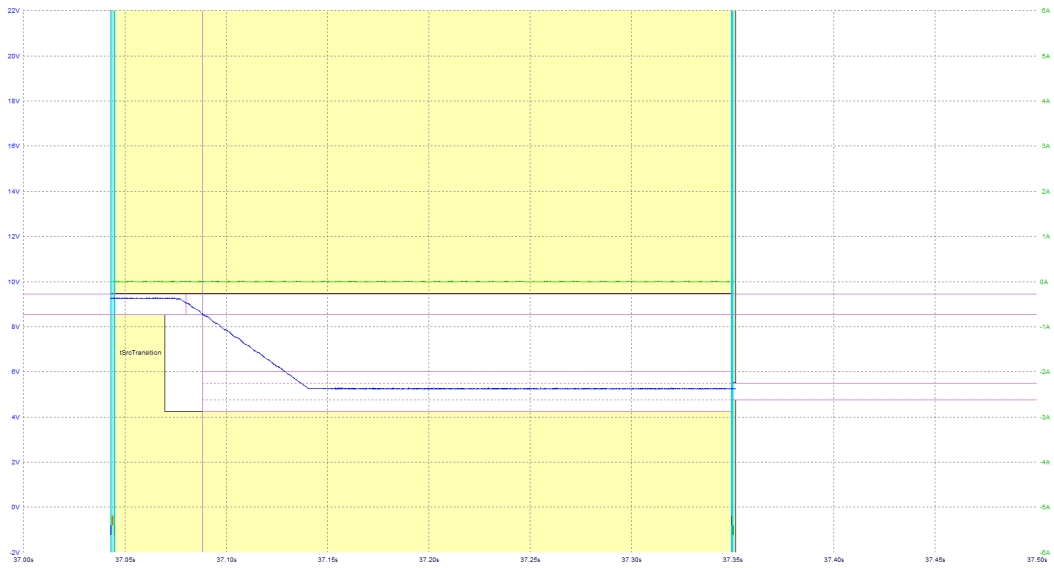
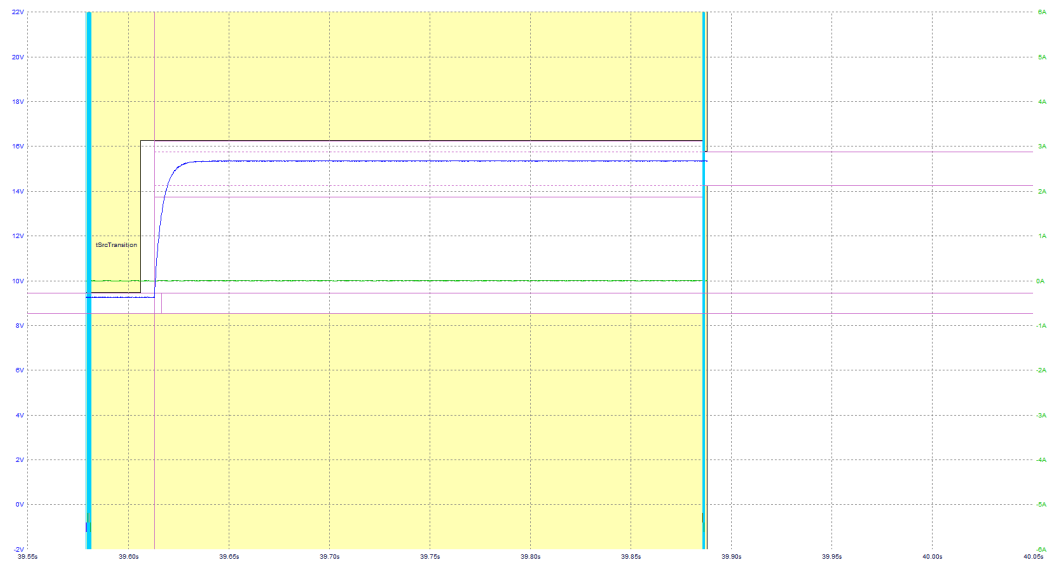
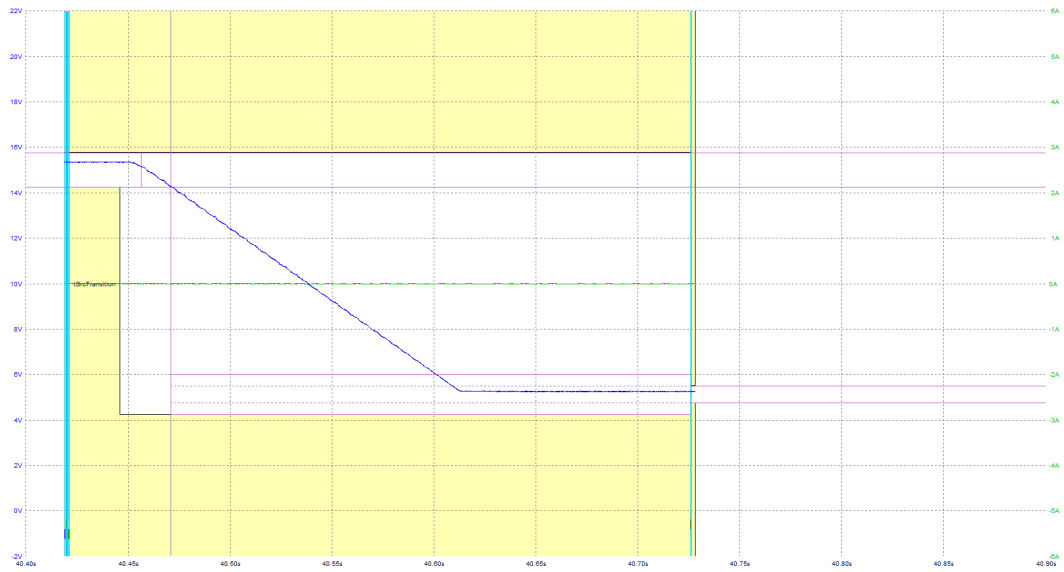
Table 7. USB PD compliance tools

Tool Name	Software (PC)	SW Version
Ellisys USB Explorer 350	USB Explorer 350 Examiner	3.1.6594
MQP USB-PDT	GraphicsUSB	5.50.05
Teledyne LeCroy Voyager M310C	USB Compliance Suite USB Protocol Suite	3.45 Build 679 7.61 Build 2615
Granite River Labs GRL-USB-PD-C1	GRL USB-PD	1.2.9.3

Refer to TN-for compliance test reports (PR7017) for details on compliance results.

RELATED LINKS

[TN1273 STEVAL-USBPD45C USB PD compliance reports](#)

7 Schematics and bill of materials

7.1 Schematics

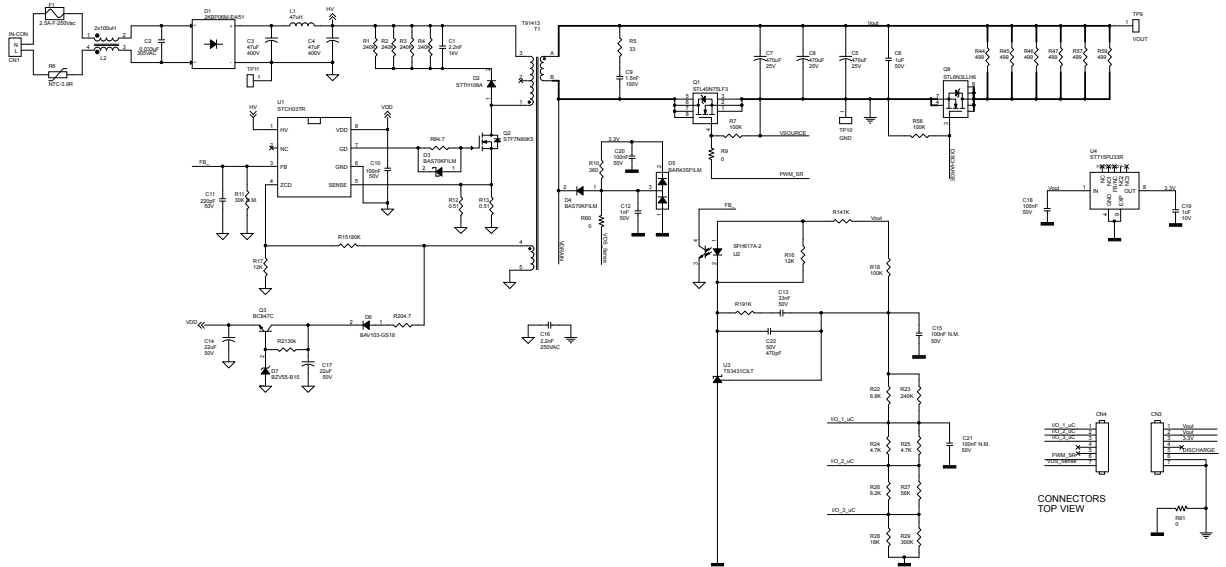
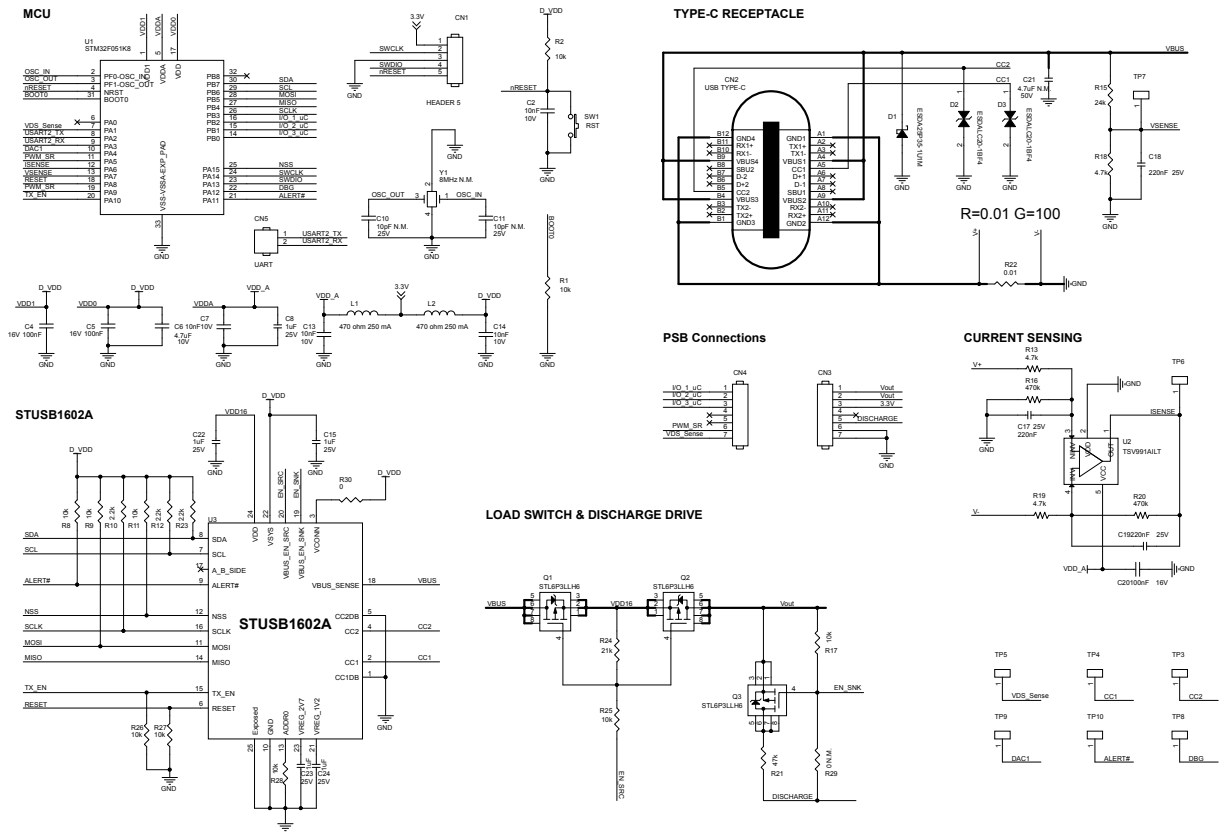
Figure 33. STEVAL-USBPD45P power supply board schematics

Figure 34. STEVAL-USBPD45I digital control board schematics

7.2 Bill of materials

Table 8. STEVAL-USBPD45P bill of materials

Item	Q.ty	Ref	Part / Value	Description	Manufacturer	Order code
1	1	CN1	IN-CON 300V _{AC}	5.08MM VERTICAL PCB HEADERS	WURTH ELEKTRONIK	691311500102
2	2	CN3,CN4	CON5	Through Hole Header 7x1 pitch 2.54mm	AMPHENOL FCI	76341-307LF
3	1	C1	2.2nF 1kV ±10%	Ceramic X7R	MURATA	GRM31BR73A222KW0 1L
4	1	C2	0.033µF 305V _{AC} ±20%	Polypropylene - EMI SUPPRESSION FILM CAPACITOR	EPCOS	B32921C3333M000
5	2	C3,C4	47µF 400V ±20%	ALUMINIUM ELCAP	Nichicon	UCY2G470MHD
6	3	C5,C7,C8	470µF 25V ±20%	ALUMINIUM ELCAP	Nichicon	UPM1E471MPD1TD
7	1	C6	1µF 50V ±10%	Ceramic X7R	WURTH ELEKTRONIK	885012207103
8	1	C9	1.5nF 100V ±10%	Ceramic X7R	ANY	ANY
9	3	C10,C18,C20	100nF 50V ±10%	Ceramic X7R	WURTH ELEKTRONIK	885012207098
10	1	C11	220pF 50V ±10%	Ceramic X7R	WURTH ELEKTRONIK	885012207082
11	1	C12	1nF 50V ±10%	Ceramic X7R	WURTH ELEKTRONIK	885012207086
12	1	C13	33nF 50V ±20%	Ceramic X7R	Multicomp	MC0402F333M500CT
13	2	C14,C17	22µF 50V ±20%	ELCAP	RUBYCON	50YXF22M5X11
14	2	C15,C21	100nF 50V ±10% (not mounted)	Ceramic X7R	WURTH ELEKTRONIK	885012207098
15	1	C16	2.2nF 250V _{AC} ±20%	Ceramic E	MURATA	DE2E3KY222MN3AM0 2F
16	1	C19	1µF 10V ±10%	Ceramic X7R	WURTH ELEKTRONIK	885012207022
17	1	C22	470pF 50V ±5%	Ceramic C0G / NP0	Multicomp	MC0402N471J500CT
18	1	D1	2KBP06M-E4/51	BRIDGE RECTIFIER	VISHAY	2KBP06M-E4/51
19	1	D2	800V	HIGH VOLTAGE ULTRAFAST RECTIFIER	ST	STTH108A
20	2	D3,D4	70V	Schottky barrier	ST	BAS70KFILM
21	1	D5		Small Signal Schottky Diode	ST	BAR43SFILM
22	1	D6		SWITCHING DIODE	VISHAY	BAV103-GS18
23	1	D7	15V ±2%	ZENER DIODE	NEXPERIA	BZV55-B15
24	1	F1	2.5A-F-250V _{AC}	FUSE SS-5F SERIES FAST ACTING	Cooper Bussmann	SS-5F-2-5A-BK
25	1	L1	47µH	DRUM FILTER CHOKE	WURTH ELEKTRONIK	7447462470

Item	Q.ty	Ref	Part / Value	Description	Manufacturer	Order code
26	1	L2	2x100 μ H 250V _{AC} \pm 30%	WE-CMB NiZn Common Mode Power Line Choke	WURTH ELEKTRONIK	744841210
27	1	Q1	75V 10A	N- CHANNELPOWER MOSFET	ST	STL40N75LF3
28	1	Q2	800V 6A	N-CHANNEL POWER MOSFET	ST	STF7N80K5
29	1	Q3		SMALL SIGNAL NPN TRANSISTOR	NEXPERIA	BC847C
30	1	Q9	30V 6A	N-CHANNEL POWER MOSFET	ST	STL6N3LLH6
31	4	R1,R2,R3,R4	240K 1/2W \pm 5%	STAND. FILM RESISTOR 200ppm/ $^{\circ}$ C	ANY	ANY
32	1	R5	33 1/4W \pm 1%	STAND. FILM RESISTOR 100ppm/ $^{\circ}$ C	ANY	ANY
33	1	R6	NTC 3.9 Ω \pm 15%	Inrush Current Limiters	MURATA	NTPAD3R9LDNB0
34	2	R7,R18,R58	100K 1/16W \pm 1%	STAND. FILM RESISTOR 100ppm/ $^{\circ}$ C	ANY	ANY
35	2	R8,R20	4.7 1/8W \pm 1%	STAND. FILM RESISTOR 100ppm/ $^{\circ}$ C	ANY	ANY
36	2	R9,R60,R61	0 1/8W \pm 1%	STAND. FILM RESISTOR 100ppm/ $^{\circ}$ C	ANY	ANY
37	1	R10	360 1/16W \pm 1%	STAND. FILM RESISTOR 100ppm/ $^{\circ}$ C	ANY	ANY
38	2	R11	30K 1/8W \pm 1% (not mounted)	STAND. FILM RESISTOR 100ppm/ $^{\circ}$ C	ANY	ANY
39	2	R12,R13	0.51 1W \pm 1%	FILM RESISTOR 100ppm/ $^{\circ}$ C	Panasonic	ERJB2BFR51V
40	1	R14	1K 1/8W \pm 1%	STAND. FILM RESISTOR 100ppm/ $^{\circ}$ C	ANY	ANY
41	1	R15	180K 1/16W \pm 1%	STAND. FILM RESISTOR 100ppm/ $^{\circ}$ C	ANY	ANY
42	2	R16,R17	12K 1/16W \pm 1%	STAND. FILM RESISTOR 100ppm/ $^{\circ}$ C	ANY	ANY
43	1	R19	1K 1/16W \pm 1%	STAND. FILM RESISTOR 100ppm/ $^{\circ}$ C	ANY	ANY
44	1	R21	30k 1/8W \pm 1%	STAND. FILM RESISTOR 100ppm/ $^{\circ}$ C	ANY	ANY

Item	Q.ty	Ref	Part / Value	Description	Manufacturer	Order code
45	1	R22	6.8K 1/16W ±1%	STAND. FILM RESISTOR 100ppm/°C	ANY	ANY
46	1	R23	240K 1/16W ±1%	STAND. FILM RESISTOR 100ppm/°C	ANY	ANY
47	2	R24,R25	4.7K 1/16W ±1%	STAND. FILM RESISTOR 100ppm/°C	ANY	ANY
48	1	R26	8.2K 1/16W ±1%	STAND. FILM RESISTOR 100ppm/°C	ANY	ANY
49	1	R27	56K 1/16W ±1%	STAND. FILM RESISTOR 100ppm/°C	ANY	ANY
50	1	R28	18K 1/16W ±1%	STAND. FILM RESISTOR 100ppm/°C	ANY	ANY
51	1	R29	300K 1/16W ±1%	STAND. FILM RESISTOR 100ppm/°C	ANY	ANY
52	6	R44,R45,R46, R47,R57,R59	499 750mW ±1%	FILM RESISTOR	VISHAY	CRCW1206499RFKEA HP
53	1	TP9	VOUT	TEST POINT	Vero Technologies	20-2137
54	1	TP10	GND	TEST POINT	Vero Technologies	20-2137
55	1	TP11	TEST POINT (not mounted)	TEST POINT	Vero Technologies	20-2137
56	1	T1	45W	Switch Mode RM10 Transformer	SUMIDA	T91413
57	1	U1		OFF-LINE CC MODE PRIMARY- SENSING SWITCHING CONTROLLER	ST	STCH03TR
58	1	U2		OPTO ISOLATOR	Vishay	SFH617A-2
59	1	U3		Shunt Voltage Reference	ST	TS3431CILT
60	1	U4	85mA	High input voltage LDO	ST	ST715PU33R
61	1	Heat-Sink	Heat-Sink 25C/W	heat sink	FISCHER ELEKTRONIK	FK 220 SA 220
62	1	CN5	IN-CON-PLUG 300Vac	5.08mm pitch straight pluggable terminal block, plug, cable mount, 2-way	WURTH ELEKTRONIK	691351500002

Table 9. STEVAL-USBPD45I bill of materials

Item	Q.ty	Ref.	Part / Value	Description	Manufacturer	Order code
1	1	CN1	HEADER 5	Through Hole Male Header 5x1 pitch 2.54mm	WURTH ELEKTRONIK	61300511121

Item	Q.ty	Ref.	Part / Value	Description	Manufacturer	Order code
2	1	CN2	USB TYPE-C	Type-C	WURTH ELEKTRONIK	632723300011
3	2	CN3, CN4	P-CONN	Through Hole Male Header 7x1 pitch 2.54mm	WURTH ELEKTRONIK	61300711121
4	1	CN5	UART (not mounted)	Through Hole Male Header 2x1 pitch 2.54mm	WURTH ELEKTRONIK	61300211121
5	4	C2, C7, C13, C14	10nF 10V ±10%	Ceramic X7R	WURTH ELEKTRONIK	885012205012
6	3	C4, C5, C20	100nF 16V ±10%	Ceramic X7R	WURTH ELEKTRONIK	885012205037
7	1	C6	4.7µF 10V ±20%	Ceramic X5R	Murata Electronics North America	GRM155R61A475MEA AD
8	5	C8, C15, C22, C23, C24	1µF 25V ±10%	Ceramic X5R	TDK	C1005X5R1V105K050 BC
9	2	C10, C11	10pF 25V ±5% (not mounted)	Ceramic C0G, NP0	WURTH ELEKTRONIK	885012005040
10	3	C17, C18, C19	220nF 25V ±10%	Ceramic X5R	TDK	C1005X5R1E224K050 BC
11	1	C21	4.7µF 50V ±10% (not mounted)	Ceramic X6S	TDK	C2012X6S1H475K125 AC
12	1	D1	22V	Transil	ST	ESDA25P35-1U1M
13	2	D2, D3	-	Single line low capacitance ESD protection	ST	ESDALC20-1BF4
14	2	L1, L2	470 Ω 250 mA	EMI Suppression Ferrite Bead	WURTH ELEKTRONIK	7427927141
15	3	Q1, Q2, Q3	-	P-CHANNEL POWER MOSFET 30V 6A	ST	STL6P3LLH6
16	10	R1, R2, R8, R9, R11, R17, R25, R26, R27, R28	10k 1/16W ±1%	STAND. FILM RESISTOR 100ppm/°C	ANY	ANY
17	3	R10, R12, R23	2.2k 1/16W ±1%	STAND. FILM RESISTOR 100ppm/°C	ANY	ANY
18	3	R13, R18, R19	4.7k 1/16W ±1%	STAND. FILM RESISTOR 100ppm/°C	ANY	ANY
19	1	R15	24k 1/16W ±1%	STAND. FILM RESISTOR 100ppm/°C	ANY	ANY
20	2	R16, R20	470k 1/16W ±1%	STAND. FILM RESISTOR 100ppm/°C	ANY	ANY
21	1	R21	47k 1/16W ±1%	STAND. FILM RESISTOR 100ppm/°C	ANY	ANY
22	1	R22	0.01 1W ±1%	FILM RESISTOR	Panasonic	ERJ8CWFR010V

Item	Q.ty	Ref.	Part / Value	Description	Manufacturer	Order code
23	1	R24	21k 1/16W ±1%	STAND. FILM RESISTOR 100ppm/°C	ANY	ANY
24	1	R29	0 N.M. 1/16W ±1% (not mounted)	STAND. FILM RESISTOR 100ppm/°C	ANY	ANY
25	1	R30	0 1/16W ±1%	STAND. FILM RESISTOR 100ppm/°C	ANY	ANY
26	1	SW1	RST	PushButton SPST	TE CONNECTIVITY	1437566-3
27	8	TP3, TP4, TP5, TP6, TP7, TP8, TP9, TP10	(not mounted)	TEST POINT	Vero Technologies	20-2137
28	1	U1	-	32-bit ARM Cortex M0 48 MHz	ST	STM32F051K8U7
29	1	U2	-	Rail to rail input/ output op-amps	ST	TSV991AILT
30	1	U3	-	USB type-C interface	ST	STUSB1602A
31	1	Y1	8MHz 10ppm (not mounted)	Crystal	ABRACON	ABM3B-8.000MHZ-10-1-U-T

Revision history

Table 10. Document revision history

Date	Version	Changes
03-May-2018	1	Initial release.
04-Jul-2018	2	Minor text edits

Contents

1	Converter specifications and description	2
2	Power supply typical waveforms	4
2.1	Startup at no load and full load conditions	4
2.2	Output voltage regulation for dynamic load variation	5
2.3	Voltage stress on the main power MOSFET at full load	6
2.4	Short-circuit conditions	7
2.5	Adapter behavior for different power profiles	8
3	Synchronous rectification	13
4	Efficiency measurements	16
4.1	Standby consumption	17
5	USBPD messages exchange and typical waveforms	18
6	USB Power Delivery compliance results	23
7	Schematics and bill of materials	24
7.1	Schematics	24
7.2	Bill of materials	24
	Revision history	30

List of figures

Figure 1.	Power supply board primary and secondary stages	2
Figure 2.	RM10 core specification	3
Figure 3.	startup; $V_{IN} = 115 V_{AC}/60 \text{ Hz}$, no load	4
Figure 4.	startup; $V_{IN} = 115 V_{AC}/60 \text{ Hz}$, $I_{OUT} = 3 \text{ A}$	4
Figure 5.	startup; $V_{IN} = 230 V_{AC}/50 \text{ Hz}$, no load	5
Figure 6.	startup; $V_{IN} = 230 V_{AC}/50 \text{ Hz}$, $I_{OUT} = 3 \text{ A}$	5
Figure 7.	Output voltage; $V_{IN} = 115 V_{AC}/60 \text{ Hz}$, $I_{OUT} = 10\%-90\%$, $1 \text{ A}/\mu\text{s}$	6
Figure 8.	output voltage; $V_{IN} = 230 V_{AC}/50 \text{ Hz}$, $I_{OUT} = 10\%-90\%$, $1 \text{ A}/\mu\text{s}$	6
Figure 9.	Voltage on power MOSFET; $V_{IN} = 90 V_{AC}/60 \text{ Hz}$, $V_{OUT} = 15 \text{ V}$, $I_{OUT} = 3 \text{ A}$, $V_{DS_max} = 404 \text{ V}$	7
Figure 10.	Voltage on power MOSFET; $V_{IN} = 264 V_{AC}/50 \text{ Hz}$, $V_{OUT} = 15 \text{ V}$, $I_{OUT} = 3 \text{ A}$, $V_{DS_max} = 620 \text{ V}$	7
Figure 11.	Short-circuit; $264 V_{AC}/50 \text{ Hz}$ $V_{OUT} = 15 \text{ V}$, $I_{OUT} = 3 \text{ A}$	8
Figure 12.	Short-circuit; $264 V_{AC}/50 \text{ Hz}$ $V_{OUT} = 15 \text{ V}$, $I_{OUT} = 3 \text{ A}$; short-circuit and hiccup mode	8
Figure 13.	Dynamic behavior $V_{IN} = 115 V_{AC}/60 \text{ Hz}$ $I_{OUT} = 0 \text{ A}$, 5 V to 15 V , transition 26 ms	9
Figure 14.	Dynamic behavior $V_{IN} = 115 V_{AC}/60 \text{ Hz}$ $I_{OUT} = 0 \text{ A}$, 15 V to 5 V , transition 154 ms	9
Figure 15.	Dynamic behavior $V_{IN} = 115 V_{AC}/60 \text{ Hz}$ $I_{OUT} = 3 \text{ A}$, 5 V to 15 V , transition 20 ms	10
Figure 16.	Dynamic behavior $V_{IN} = 115 \text{ Vac}/60 \text{ Hz}$ $I_{OUT} = 3 \text{ A}$, 15V to 5 V , transition 150 ms	10
Figure 17.	Dynamic behavior $V_{IN} = 230 V_{AC}/50 \text{ Hz}$ $I_{OUT} = 0 \text{ A}$, 5 V to 15 V , transition 25 ms	11
Figure 18.	Dynamic behavior $V_{IN} = 230 V_{AC}/50 \text{ Hz}$ $I_{OUT} = 0 \text{ A}$, 15 V to 5 V , transition 156 ms	11
Figure 19.	Dynamic behavior $V_{IN} = 230 V_{AC}/50 \text{ Hz}$ $I_{OUT} = 3 \text{ A}$, 5 V to 15 V , transition 155 ms	12
Figure 20.	Dynamic behavior $V_{IN} = 230 V_{AC}/50 \text{ Hz}$ $I_{OUT} = 3 \text{ A}$, 15 V to 5 V , transition 155 ms	12
Figure 21.	V_{DS_SENSE} and PWM_{SR} waveform examples	13
Figure 22.	Synchronous rectification waveforms with 5 V output	14
Figure 23.	Synchronous rectification waveforms with 9 V output	14
Figure 24.	Synchronous rectification waveforms with 15 V output	15
Figure 25.	Explicit Power Delivery contract negotiation	18
Figure 26.	Eye diagram of USBPD transceiver	19
Figure 27.	Transition from 5 V to 9 V	19
Figure 28.	Transition from 5 V to 15 V	20
Figure 29.	Transition from 9 V to 15 V	20
Figure 30.	Transition from 5 V to 15 V	21
Figure 31.	Transition from 15 V to 5 V	21
Figure 32.	Transition from 15 V to 9 V	22
Figure 33.	STEVAL-USBPD45P power supply board schematics	24
Figure 34.	STEVAL-USBPD45I digital control board schematics	24

List of tables

Table 1.	Converter design specifications	2
Table 2.	Efficiency results for the 15 W power profile.	16
Table 3.	Efficiency results for the 27 W power profile.	16
Table 4.	Efficiency results for the 45 W power profile.	16
Table 5.	Four-point-average efficiency	17
Table 6.	Stand-by consumption	17
Table 7.	USB PD compliance tools	23
Table 8.	STEVAL-USBPD45P bill of materials	25
Table 9.	STEVAL-USBPD45I bill of materials	27
Table 10.	Document revision history	30

IMPORTANT NOTICE – PLEASE READ CAREFULLY

STMicroelectronics NV and its subsidiaries (“ST”) reserve the right to make changes, corrections, enhancements, modifications, and improvements to ST products and/or to this document at any time without notice. Purchasers should obtain the latest relevant information on ST products before placing orders. ST products are sold pursuant to ST’s terms and conditions of sale in place at the time of order acknowledgement.

Purchasers are solely responsible for the choice, selection, and use of ST products and ST assumes no liability for application assistance or the design of Purchasers’ products.

No license, express or implied, to any intellectual property right is granted by ST herein.

Resale of ST products with provisions different from the information set forth herein shall void any warranty granted by ST for such product.

ST and the ST logo are trademarks of ST. All other product or service names are the property of their respective owners.

Information in this document supersedes and replaces information previously supplied in any prior versions of this document.

© 2018 STMicroelectronics – All rights reserved