

Using the UCC28704EVM-724 10-W USB Adapter

User's Guide



Literature Number: SLUUBF1

February 2016



WARNING

Always follow TI's set-up and application instructions, including use of all interface components within their recommended electrical rated voltage and power limits. Always use electrical safety precautions to help ensure your personal safety and the safety of those working around you. Contact TI's Product Information Center <http://support/ti.com> for further information.

Save all warnings and instructions for future reference.

Failure to follow warnings and instructions may result in personal injury, property damage, or death due to electrical shock and/or burn hazards.

The term TI HV EVM refers to an electronic device typically provided as an open framed, unenclosed printed circuit board assembly. It is intended strictly for use in development laboratory environments, solely for qualified professional users having training, expertise, and knowledge of electrical safety risks in development and application of high-voltage electrical circuits. Any other use and/or application are strictly prohibited by Texas Instruments. If you are not suitably qualified, you should immediately stop from further use of the HV EVM.

1. Work Area Safety:

- (a) Keep work area clean and orderly.
- (b) Qualified observer(s) must be present anytime circuits are energized.
- (c) Effective barriers and signage must be present in the area where the TI HV EVM and its interface electronics are energized, indicating operation of accessible high voltages may be present, for the purpose of protecting inadvertent access.
- (d) All interface circuits, power supplies, evaluation modules, instruments, meters, scopes and other related apparatus used in a development environment exceeding $50 V_{RMS}/75 V_{DC}$ must be electrically located within a protected Emergency Power Off (EPO) protected power strip.
- (e) Use a stable and non-conductive work surface.
- (f) Use adequately insulated clamps and wires to attach measurement probes and instruments. No freehand testing whenever possible.

2. Electrical Safety:

- (a) De-energize the TI HV EVM and all its inputs, outputs, and electrical loads before performing any electrical or other diagnostic measurements. Revalidate that TI HV EVM power has been safely de-energized.
- (b) With the EVM confirmed de-energized, proceed with required electrical circuit configurations, wiring, measurement equipment hook-ups and other application needs, while still assuming the EVM circuit and measuring instruments are electrically live.
- (c) Once EVM readiness is complete, energize the EVM as intended.

WARNING: while the EVM is energized, never touch the EVM or its electrical circuits as they could be at high voltages capable of causing electrical shock hazard.

3. Personal Safety:

- (a) Wear personal protective equipment e.g. latex gloves and/or safety glasses with side shields or protect EVM in an adequate lucent plastic box with interlocks from accidental touch.

4. Limitation for Safe Use:

- (a) EVMs are not to be used as all or part of a production unit.

Using the UCC28704EVM-724 10-W USB Adapter

1 Description

The UCC28704EVM-724 is a 10-W evaluation module for evaluating an off-line adapter for USB applications. The EVM meets CoC tier 2 and DoE Level 6 efficiency and standby power requirements. It is intended for evaluation purposes and is not intended to be an end product. The UCC28704EVM-724 converts 85- V_{RMS} to 265- V_{RMS} input voltage down to 5- V_{DC} , with a 2.1-A current limit for USB adapter applications.

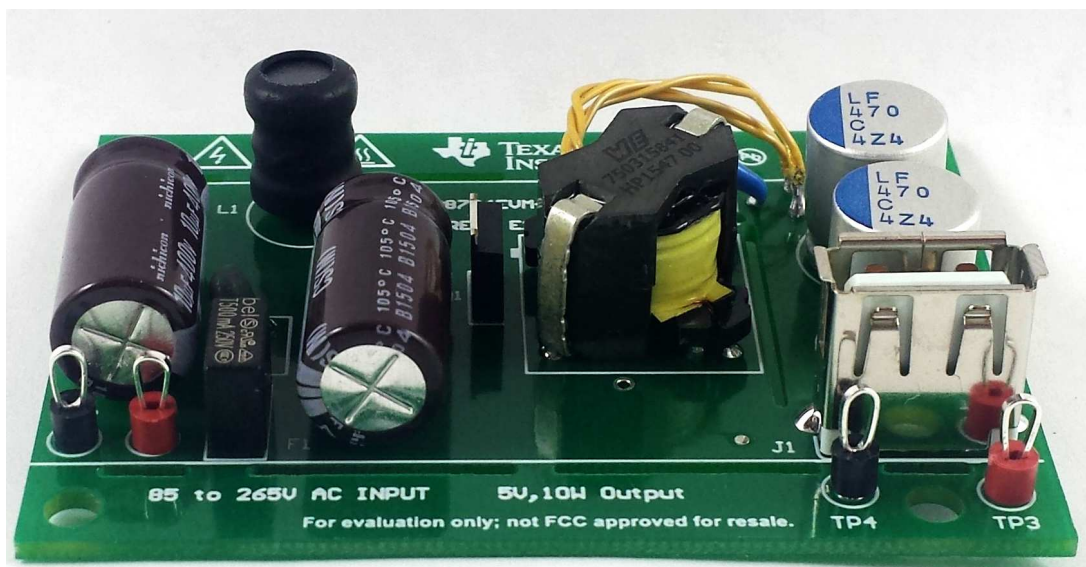

Figure 1. UCC28704EVM-724

2 Electrical Performance Specifications

Table 1. UCC28704EVM-724 Electrical Performance Specifications

PARAMETER		TEST CONDITIONS	MIN	TYP	MAX	UNIT
INPUT CHARACTERISTICS						
V_{IN}	Input voltage (RMS)		85	115/230	265	V
f_{LINE}	Line frequency		47	50/60	63	Hz
P_{STBY}	No load input power	$V_{IN} = 115\text{ V} / 230\text{ V RMS}, I_{OUT} = 0\text{ A}$		50	65	mW
OUTPUT CHARACTERISTICS						
V_{OUT}	Output voltage ⁽¹⁾	$V_{IN} = \text{nom}, I_{OUT} = \text{nom}$	4.75		5.25	V
V_{OUT}	Output ripple voltage ⁽²⁾	$V_{IN} = \text{nom}, I_{OUT} = \text{max},$			80	mVpp
I_{OUT}	Output current	$V_{IN} = \text{min to max}$		2	2.2	A
I_{OUT}	Constant current	$V_{IN} = \text{min to max}$	2	2.1	2.2	A
	Load step	0 A to 0.5 A	4.1		6	V
SYSTEMS CHARACTERISTICS						
η	4-point average efficiency	25%, 50%, 75% and 100% load, 115-V / 230-V RMS input		83%		
η	4-point average efficiency ⁽¹⁾	25%, 50%, 75% and 100% load, 115-V / 230-V RMS input		80%		
η	10% Efficiency	115-V / 230-V RMS input	75%	77%		
	Operating temperature range	$V_{IN} = \text{min to max}, I_{OUT} = \text{min to max}$		25		°C

⁽¹⁾ Specification includes loss from 0.15- Ω cable.

⁽²⁾ Specification measured at the end of 1 m of 0.15- Ω cable with 100 nF of filter capacitance.

3 Schematic

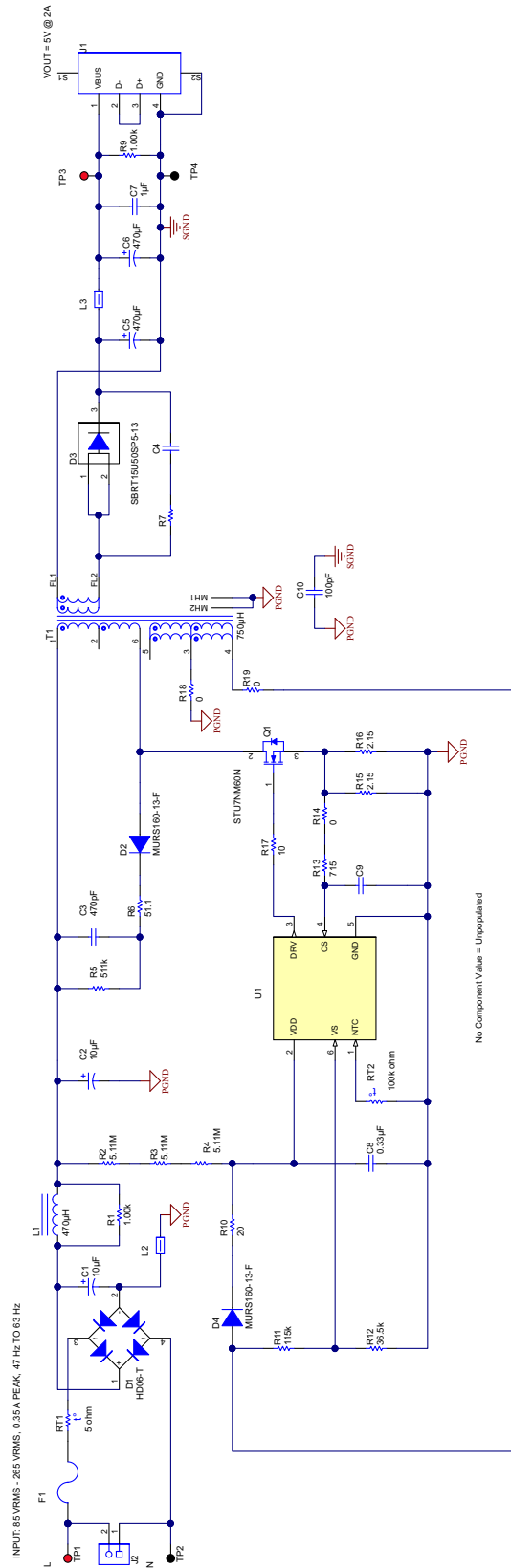

Figure 2. UCC28704EVM-724 Schematic

4 Test Setup

4.1 Test Setup Requirements

Safety: This evaluation module is not encapsulated and there are voltages that are much greater than 50 V_{DC}.

WARNING
If you are not trained in the proper safety of handling and testing power electronics please do not test this evaluation module.

Voltage Source: Isolated AC source or variable AC transformer capable of 265 V_{AC} cable of handling 10 W

Voltmeter: Digital voltage meter

Power Analyzer: Capable of measuring 1 mW to 10 W of input power and capable of handling 265-V RMS input voltage. Some power analyzers may require a precision shunt resistor for measuring input current to measure input power of 5 W or less. Please read the power analyzer's user manual for proper setup.

Oscilloscope:

- 4 Channel 100 MHz.
- Probes capable of handling 600 V.

Output Load: Resistive or electronic load capable handling 15 W at 5 V.

Recommended Wire Gauge: Insulated 22 AWG.

4.2 Test Setup Diagram

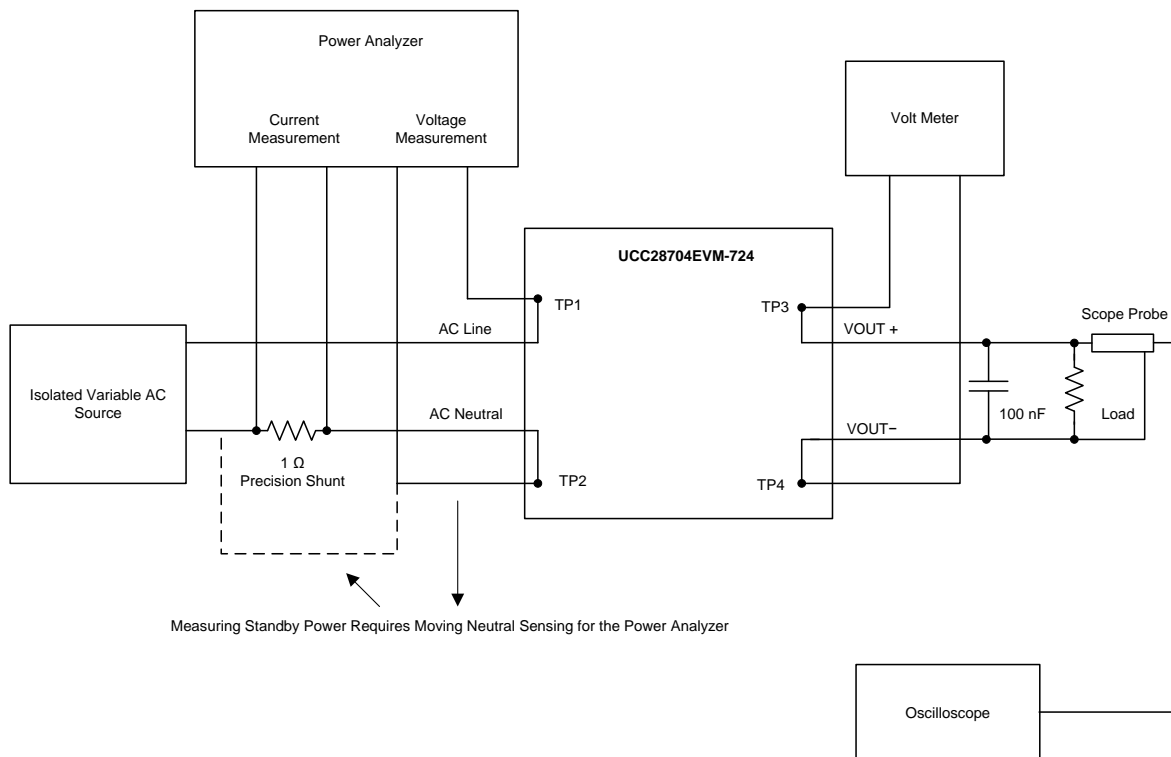

Figure 3. UCC28704EVM-724 Test Setup Diagram

5 Test Points

Table 2. Test Point Functions

TEST POINTS	NAME	DESCRIPTION
TP1	L	AC line voltage input
TP2	N	AC neutral input
TP3	VOUT +	Output supply
TP4	VOUT –	Output return

6 Performance Data and Typical Characteristic Curves

6.1 Efficiency

Table 3. Efficiency Test Data

V _{IN} RMS	V _{OUT}	I _{OUT}	P _{IN}	EFFICIENCY WITH CABLE	EFFICIENCY AVERAGE WITH CABLE	EFFICIENCY WITHOUT CABLE	EFFICIENCY AVERAGE WITHOUT CABLE
85	5.120	0.000	0.032	N/A	N/A	N/A	N/A
85	5.346	2.003	13.132	77.0%	N/A	81.5%	N/A
265	5.123	0.000	0.055	N/A	N/A	N/A	N/A
265	5.346	2.003	12.856	78.6%	N/A	83.3%	N/A
115	5.121	0.000	0.036	N/A	N/A	N/A	
115	5.115	0.200	1.267	80.3%		80.7%	
115	5.154	0.501	3.095	82.2%		83.4%	
115	5.221	1.001	6.238	81.4%		83.8%	
115	5.283	1.502	9.495	80.0%		83.6%	
115	5.348	2.003	12.796	79.0%	80.7%	83.7%	83.6%
230	5.122	0.000	0.050	N/A		N/A	
230	5.116	0.200	1.327	76.7%		77.1%	
230	5.150	0.501	3.152	80.7%		81.9%	
230	5.214	1.001	6.241	81.2%		83.6%	
230	5.281	1.502	9.482	80.1%		83.7%	
230	5.334	2.003	12.735	79.2%	80.3%	83.9%	83.3%

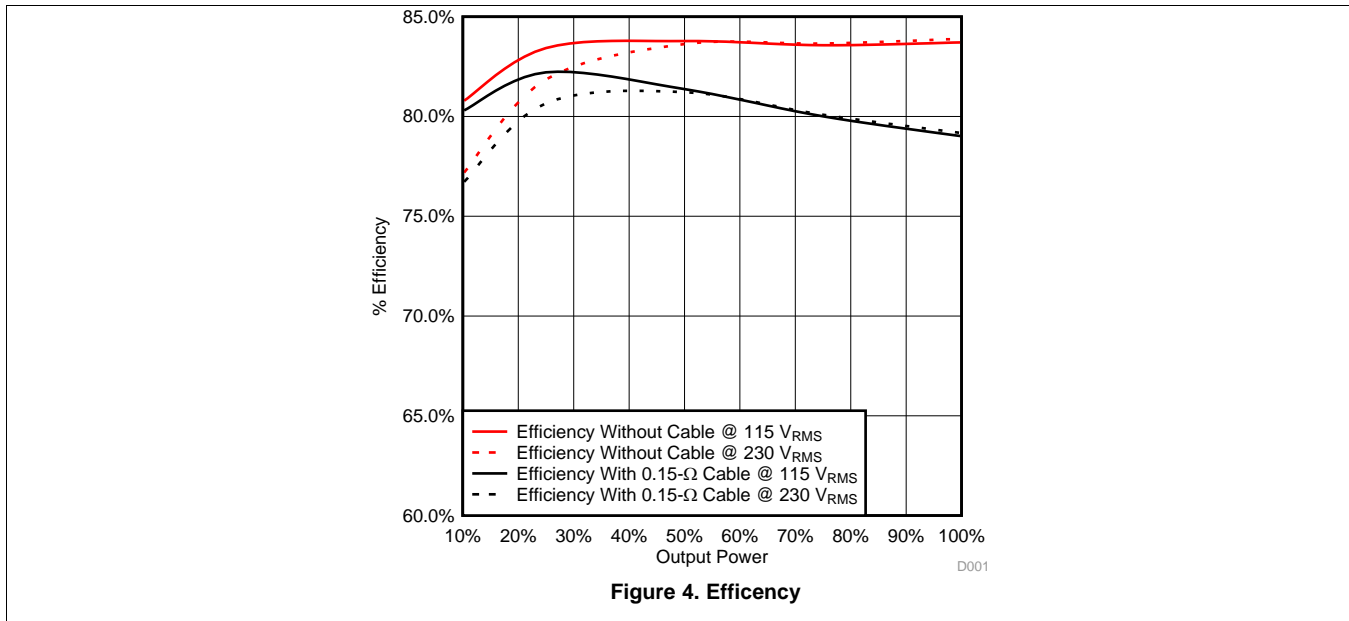

6.2 VI Characteristics

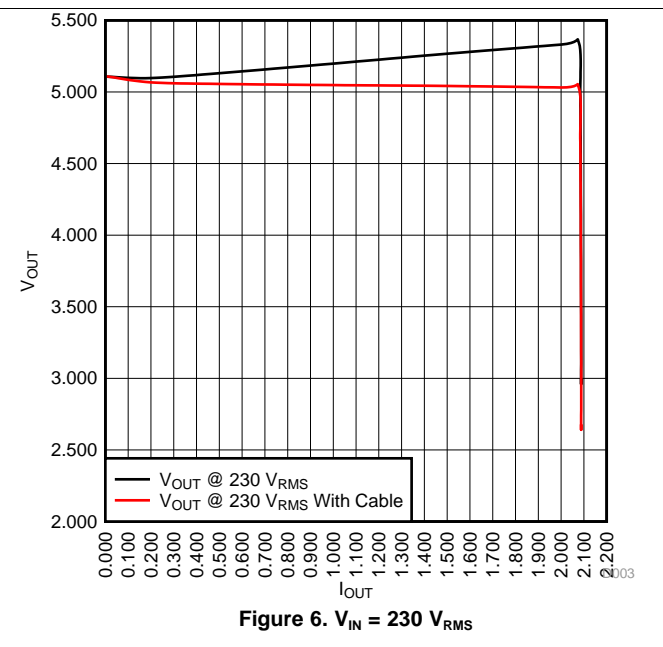
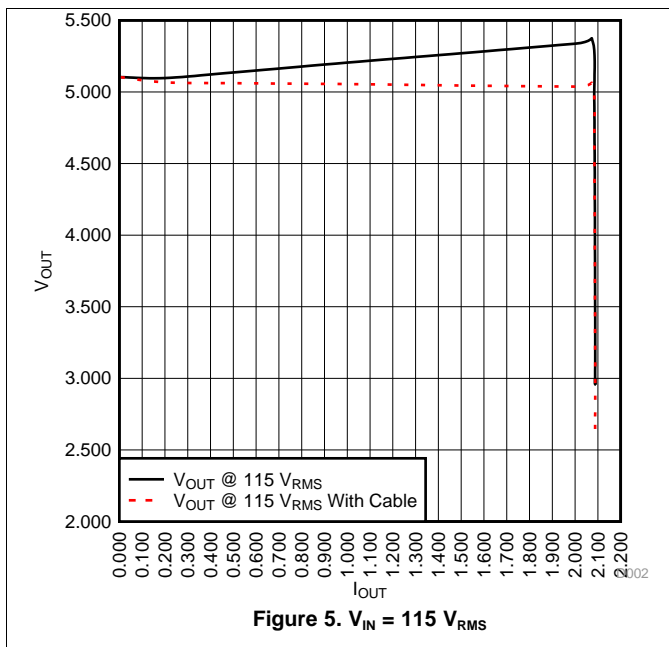

6.3 Startup

CH1 = Aux (D4 Anode), CH2 = V_{OUT} , CH3 = V_{RCS} (R16), CH4 = V_{IN} (C1), $R_{LOAD} = 2.5 \Omega$

CH1 = 100 V/div, CH2 = 5 V/div, CH3 = 1 V/div, CH4 = 200 V/div

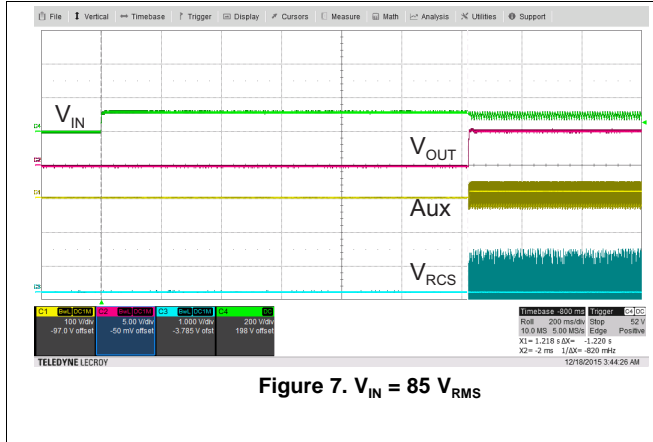

CH1 = Aux (D4 Anode), CH2 = V_{OUT} , CH3 = V_{RCS} (R16), CH4 = V_{VDD} (C8)

CH1 = 100 V/div, CH2 = 2 V/div, CH3 = 1 V/div, CH4 = 20 V/div

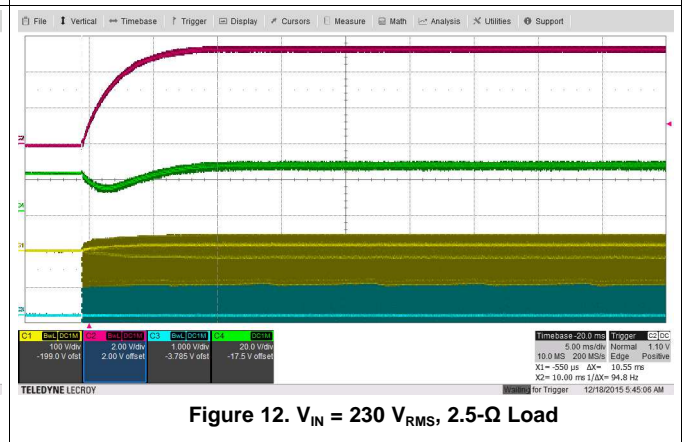
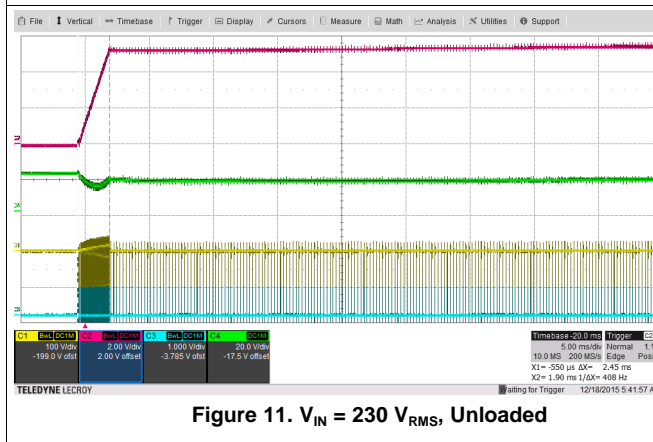
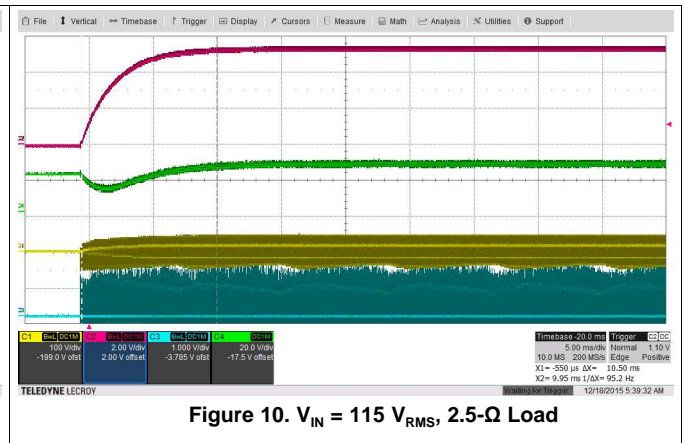
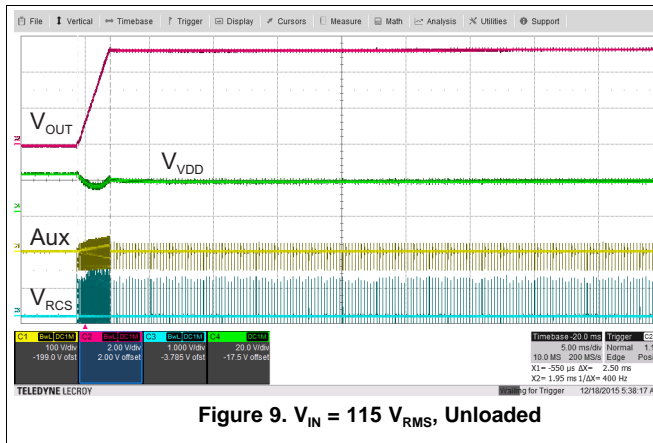

6.4 Load Transients

CH1 = V_{OUT} , CH2 = I_{OUT} , CH3 = V_{RCS} (R16), CH4 = I_{OUT}

CH1 = 100 V/div, CH2 = 1 V/div, CH3 = 2 V/div, CH4 = 2 A/div

Load = 0 to 2 A, 50 Hz, 50% Duty Cycle

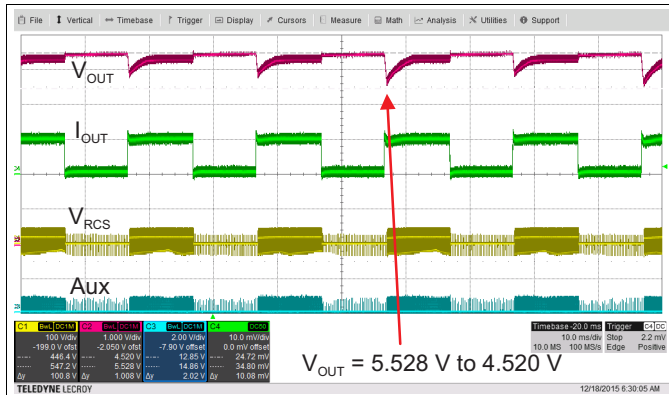

Figure 13. $V_{IN} = 85$ V RMS

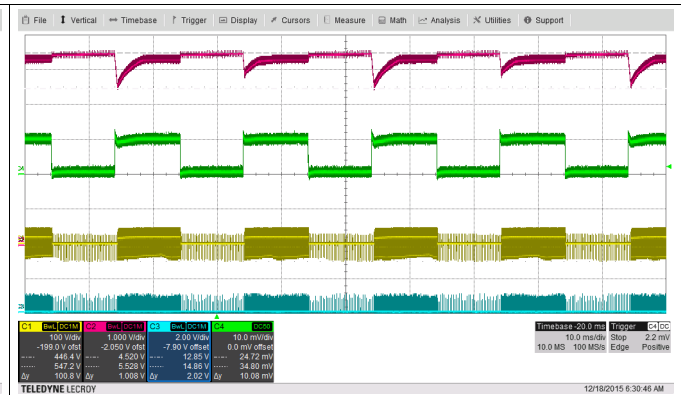

Figure 14. $V_{IN} = 115$ V RMS

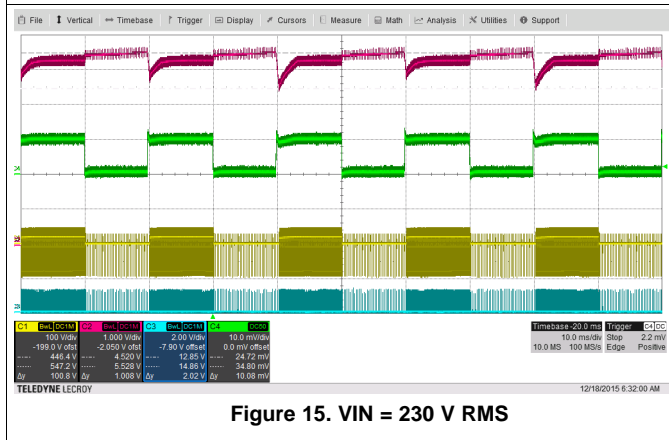

Figure 15. $V_{IN} = 230$ V RMS

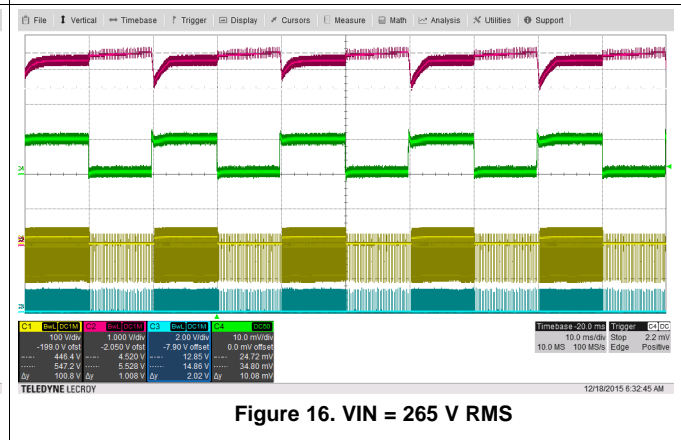

Figure 16. $V_{IN} = 265$ V RMS

6.5 Output Ripple Voltage at Full Load

CH1 = V_{OUT} at EVM output, CH2 = V_{OUT} measured at the end of the 3 m of cable in parallel with a 100-nF capacitor. The output voltage has less than 80 mV of output ripple at the end of the cable.

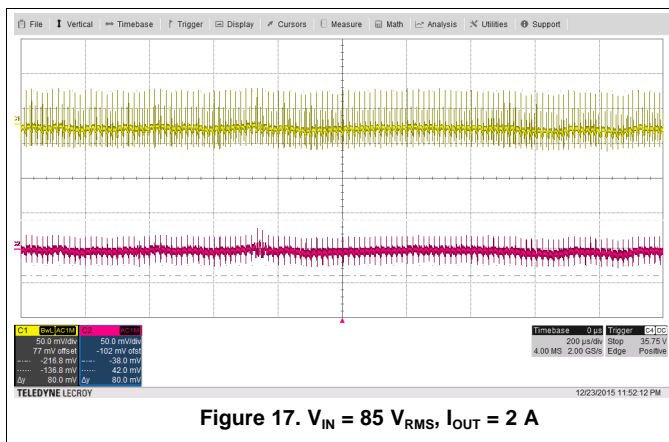

Figure 17. $V_{IN} = 85$ V_{RMS}, $I_{OUT} = 2$ A

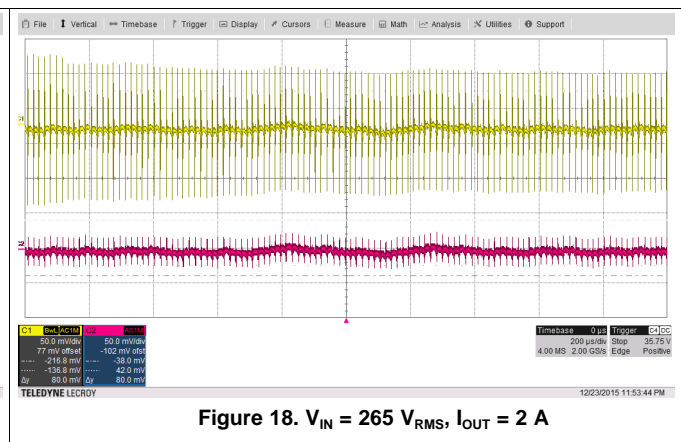
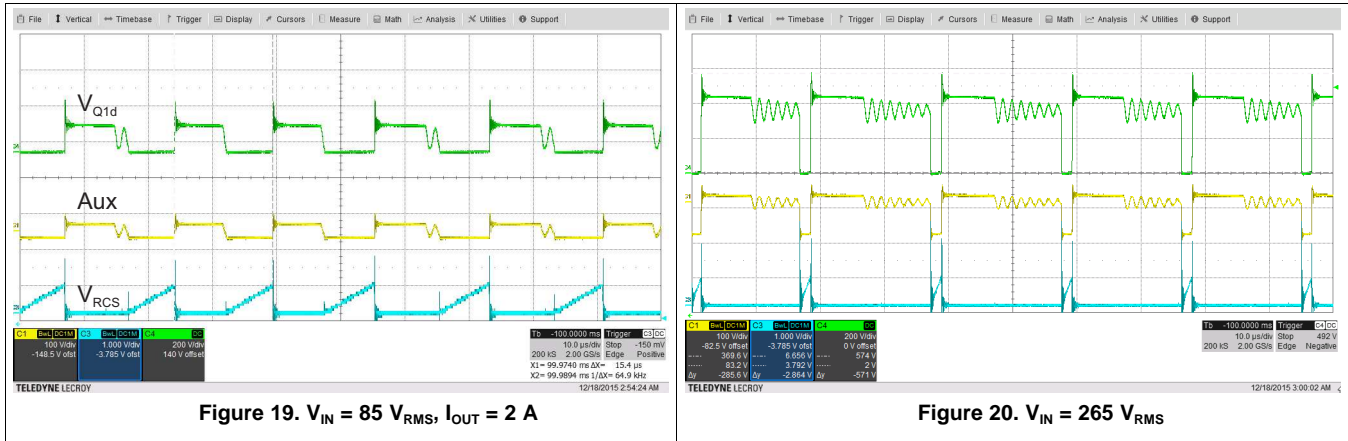

Figure 18. $V_{IN} = 265$ V_{RMS}, $I_{OUT} = 2$ A

6.6 Q1 Drain Voltage Evaluation

CH1 = Aux (D4 Anode), CH3 = V_{RCS} (R15), CH3 = Q1d

CH1 = 100 V/div, CH3 = 1 V/div, CH4 = 200 V/div



6.7 Constant Current Under Voltage Protection

The UCC28704 has constant current under voltage protection (CCUV) that can be used to protect the converter from excessive loading for long periods of time. When the output is pulled below 2.95 V for greater than 120 ms in this design the UCC28704 activates CCUV protection. The converter will stop switching and charge and discharge the VDD capacitor (C8) 4 times between ULVO turn on and turnoff before trying to restart the adapter. After VDD reaches the UCC28704 UVLO turn on threshold it will then attempt to restart. If the fault condition remains the UCC28704 will enter the fault condition again and will repeat the cycling of the VDD capacitor until the fault is cleared. Please refer to the UCC28704 data sheet for more details. The waveform in Figure 21 show this CCUV fault behavior with the output loaded with a 2.9-V constant voltage load briefly.

CH1 = V_{VDD} , CH2 = V_{OUT} , CH3 = V_{RCS} (R16), CH4 = Aux (D4 Anode)

CH1 = 10 V/div, CH2 = 2 V/div, CH3 = 2 V/div, CH4 = 100 V/div

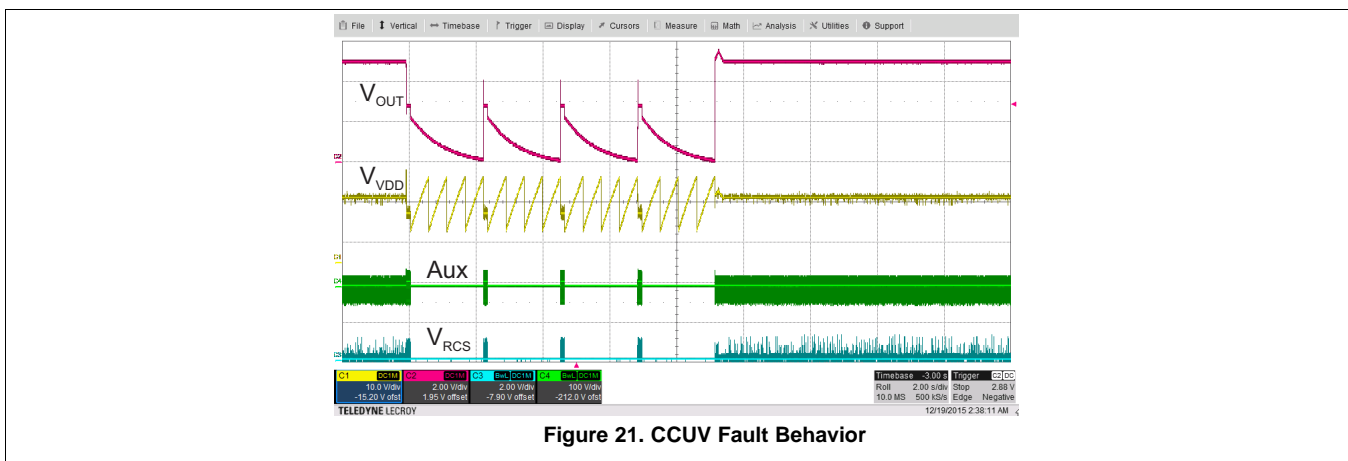

6.8 Conducted EMI Output Grounded to LISN ground

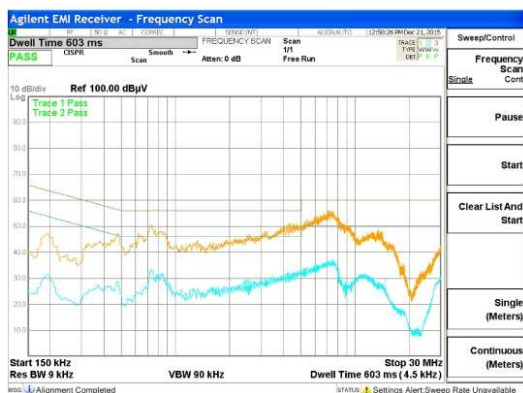

Figure 22. VIN = 115 V_{RMS}, Load = 2.5 Ω

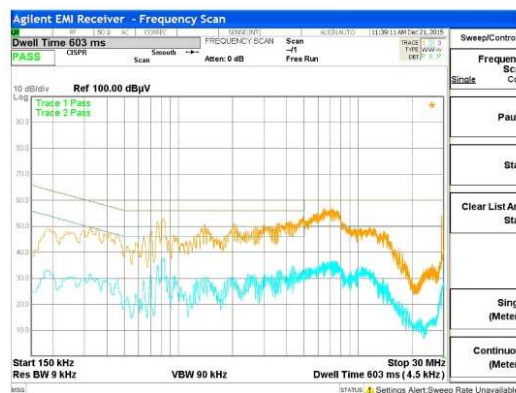

Figure 23. VIN = 115 V_{RMS}, Load = 2.5 Ω

NOTE: Please note this was evaluated on an unqualified EMI station. It is recommended that all final designs be verified by agency qualified EMI test house.

7 Transformer Details

Würth Elektronik transformer part number 750315841 is used on this design and wound on an RM6 core.

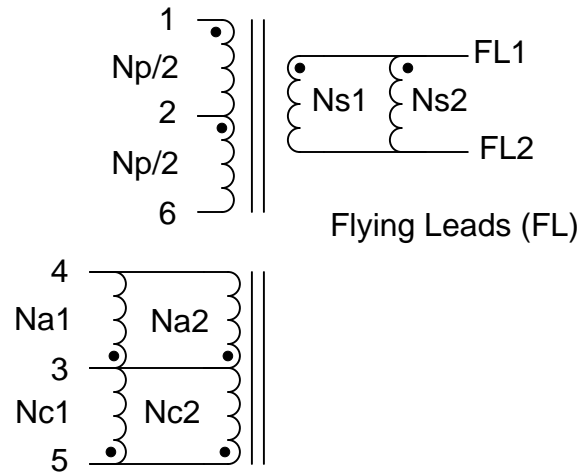
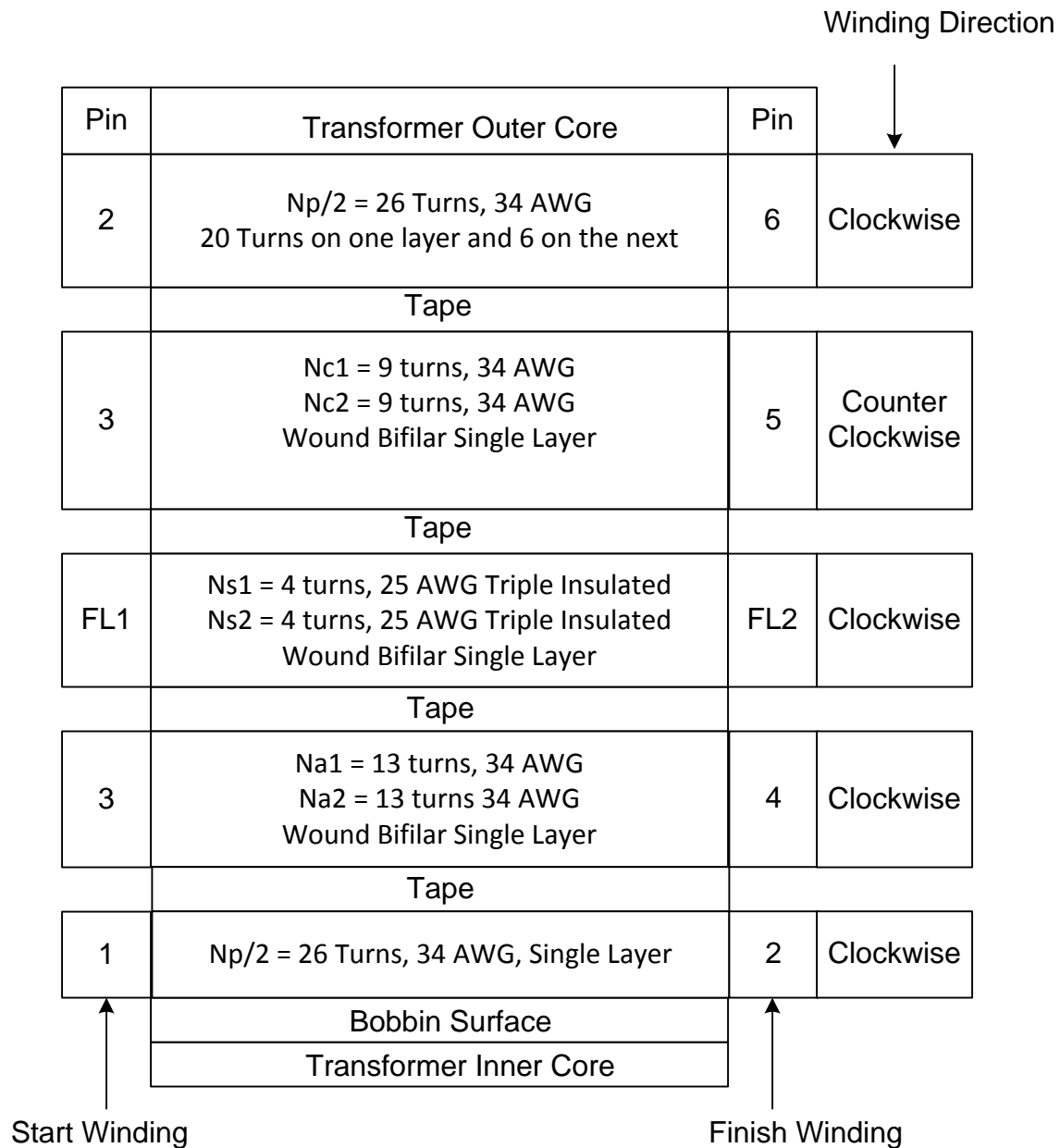

Figure 24. Transformer Schematic

Table 4. Transformer Specifications

PARAMETER	PINS/LEADS	TEST CONDITIONS	VALUE
D.C. resistance	1 – 2	At 20°C	0.56 Ω, ±10%
D.C. resistance	3 – 4	At 20°C	0.157 Ω, ±10%
D.C. resistance	FL1 – FL2	At 20°C	0.012 Ω, ±20%
D.C. resistance	3 – 5	At 20°C	0.142 Ω, ±10%
D.C. resistance	2 – 6	At 20°C	0.845 Ω, ±10%
Inductance	1 – 6	10 kHz, 100 mV, Ls	750 μH, ±10%
Saturation current	1 – 6	20% rolloff from initial	800 mA
Leakage inductance	1 – 6	tie (FL1 + FL2, 3 + 4 + 5), 100 kHz, 100 mV, Ls	4.0 μH typical, 6.0 μH maximum
Dielectric	6vFL1	tie (5 + 6), 3750 V _{AC} , 1 second	
Turns ratio		(1 – 6):(FL1 – FL2)	13:1, ±1%
Turns ratio		(1 – 6):(3 – 4)	4:1, ±1%
Turns ratio		(1 – 6):(5 – 3)	5.78:1, ±1%
Turns ratio		(1 – 2):(2 – 6)	1:1, ±1%

Figure 25. Transformer Winding Structure

8 EVM Assembly and Layout

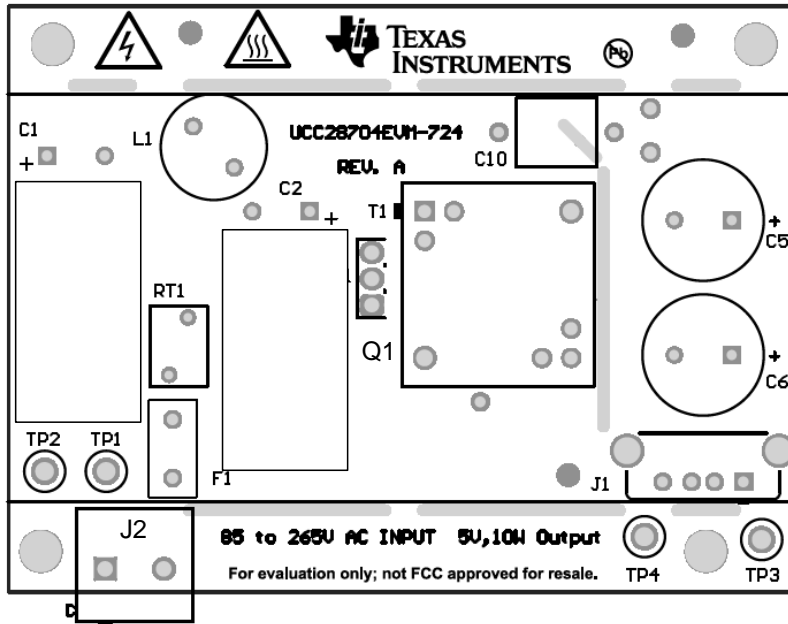

Figure 26. EVM Assembly (Top View)

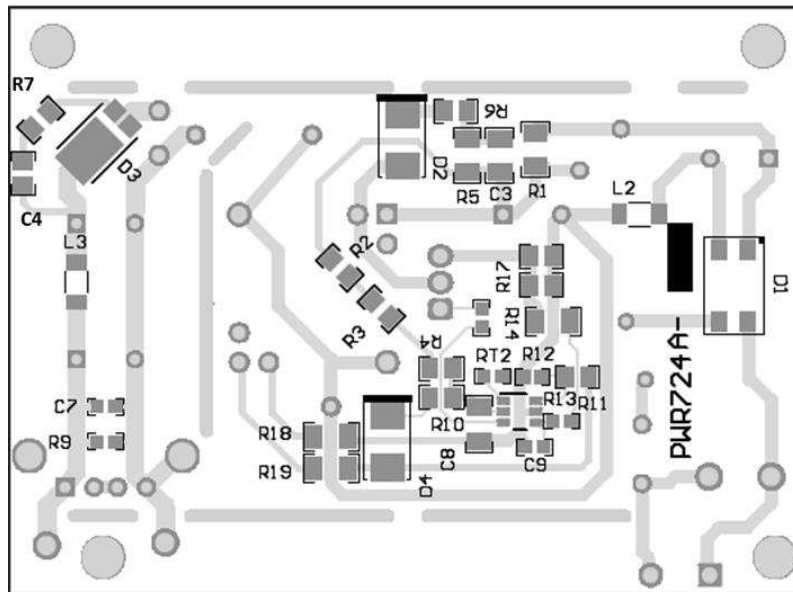

Figure 27. EVM Assembly/Layout (Bottom View)

9 List of Materials

UCC28704EVM-724 list of materials as shown in [Figure 2](#).

Table 5. UCC28704EVM-724 List of Materials

Quantity	Designat or	Description	PartNumber	Manufacturer
2	C1, C2	Capacitor, aluminum, 10 μ F, 400 V, \pm 20%, TH	UCS2G100MPD1TD	Nichicon
1	C3	Capacitor, ceramic, 470 pF, 630 V, \pm 5%, U2J, 1206	GRM31A7U2J471JW31D	MuRata
0	C4	Capacitor, ceramic, 100 pF, 50 V, \pm 5%, C0G/NP0, 0805	08055A101JAT2A	AVX
2	C5, C6	Capacitor, aluminum, 470 μ F, 16 V, \pm 20%, 0.009 ohm, TH	PLF1C471MDO1	Nichicon
1	C7	Capacitor, ceramic, 1 μ F, 25 V, \pm 10%, X7R, 0603	C1608X7R1E105K080AB	TDK
1	C8	Capacitor, ceramic, 0.33 μ F, 50 V, \pm 10%, X7R, 1206	GRM319R71H334KA01D	MuRata
0	C9	Capacitor, ceramic, 27 pF, 50 V, \pm 5%, C0G/NP0, 0603	06035A270JAT2A	AVX
1	C10	Capacitor, ceramic, 100 pF, 440 V, \pm 10%, B, 7.0 mm \times 11.0 mm \times 7.0 mm	CD70-B2GA101KYNKA	TDK
1	D1	Diode, switching-bridge, 600 V, 0.8 A, MiniDIP	HD06-T	Diodes Inc.
2	D2, D4	Diode, ultrafast, 600 V, 1 A, SMB	MURS160-13-F	Diodes Inc.
1	D3	Diode, super barrier rectifier, 50 V, 15 A, AEC-Q101, PowerDI5	SBRT15U50SP5-13	Diodes Inc.
1	F1	Fuse, 0.5 A, 250 V _{AC} /V _{DC} , TH	RST 500	Bel Fuse
1	J1	Connector, receptacle, USB type A, vertical, TH	923	Keystone
1	J2	2 pos terminal block	1715721	Phoenix Contact
1	L1	Inductor, wirewound, ferrite, 470 μ H, 0.5 A, 1.3 Ω , TH	RLB0914-471KL	Bourns
2	L2, L3	Ferrite bead, 300 Ω at 100 MHz, 3 A, 1206_190	742792121	Würth Elektronik
1	Q1	MOSFET, N-channel, 600 V, 5 A, IPAK	STU7NM60N	STMicroelectronics
1	R1	Resistor, 1.00 k Ω , 1%, 0.25 W, 1206	CRCW12061K00FKEA	Vishay-Dale
3	R2, R3, R4	Resistor, 5.11 M Ω , 1%, 0.125 W, 0805	CRCW08055M11FKEA	Vishay-Dale
1	R5	Resistor, 511 k Ω , 1%, 0.25 W, 1206	CRCW1206511KFKEA	Vishay-Dale
1	R6	Resistor, 51.1, 1%, 0.125 W, 0805	CRCW080551R1FKEA	Vishay-Dale
0	R7	Resistor, 510 k Ω , 5%, 0.125 W, 0805	CRCW0805510KJNEA	Vishay-Dale
1	R9	Resistor, 1.00 k Ω , 1%, 0.1 W, 0603	CRCW06031K00FKEA	Vishay-Dale
1	R10	Resistor, 20 Ω , 5%, 0.125 W, 0805	CRCW080520R0JNEA	Vishay-Dale
1	R11	Resistor, 115 k Ω , 1%, 0.125 W, 0805	CRCW0805115KFKEA	Vishay-Dale
1	R12	Resistor, 36.5 k Ω , 1%, 0.1 W, 0603	CRCW060336K5FKEA	Vishay-Dale
1	R13	Resistor, 715 Ω , 1%, 0.1 W, 0603	RC0603FR-07715RL	Yageo America
3	R14, R18, R19	Resistor, 0 Ω , 5%, 0.25 W, 1206	MCR18EZHJ000	Rohm
2	R15, R16	Resistor, 2.15 Ω , 1%, 0.125 W, 0805	CRCW08052R15FKEA	Vishay-Dale
1	R17	Resistor, 10 Ω , 5%, 0.25 W, 0603	CRCW060310R0JNEAHP	Vishay-Dale
1	RT1	Thermistor NTC, 5 Ω , 20%, MF72D5 TH	MF72-005D5	Cantherm
1	RT2	Thermistor NTC, 100 k Ω , 1%, 0603	NTCG164KF104F	TDK
1	T1	Transformer, 750 μ H, TH	750315841	Würth Elektronik
2	TP1, TP3	Test point, multipurpose, red, TH	5010	Keystone
2	TP2, TP4	Test point, multipurpose, black, TH	5011	Keystone
1	U1	CV/CC Flyback Controller with Primary-Side Regulation (PSR) and CC Under-Voltage Protection, DBV0006A	UCC28704DBVR-1	Texas Instruments

STANDARD TERMS AND CONDITIONS FOR EVALUATION MODULES

1. *Delivery:* TI delivers TI evaluation boards, kits, or modules, including any accompanying demonstration software, components, or documentation (collectively, an "EVM" or "EVMs") to the User ("User") in accordance with the terms and conditions set forth herein. Acceptance of the EVM is expressly subject to the following terms and conditions.
 - 1.1 EVMs are intended solely for product or software developers for use in a research and development setting to facilitate feasibility evaluation, experimentation, or scientific analysis of TI semiconductors products. EVMs have no direct function and are not finished products. EVMs shall not be directly or indirectly assembled as a part or subassembly in any finished product. For clarification, any software or software tools provided with the EVM ("Software") shall not be subject to the terms and conditions set forth herein but rather shall be subject to the applicable terms and conditions that accompany such Software
 - 1.2 EVMs are not intended for consumer or household use. EVMs may not be sold, sublicensed, leased, rented, loaned, assigned, or otherwise distributed for commercial purposes by Users, in whole or in part, or used in any finished product or production system.
2. *Limited Warranty and Related Remedies/Disclaimers:*
 - 2.1 These terms and conditions do not apply to Software. The warranty, if any, for Software is covered in the applicable Software License Agreement.
 - 2.2 TI warrants that the TI EVM will conform to TI's published specifications for ninety (90) days after the date TI delivers such EVM to User. Notwithstanding the foregoing, TI shall not be liable for any defects that are caused by neglect, misuse or mistreatment by an entity other than TI, including improper installation or testing, or for any EVMs that have been altered or modified in any way by an entity other than TI. Moreover, TI shall not be liable for any defects that result from User's design, specifications or instructions for such EVMs. Testing and other quality control techniques are used to the extent TI deems necessary or as mandated by government requirements. TI does not test all parameters of each EVM.
 - 2.3 If any EVM fails to conform to the warranty set forth above, TI's sole liability shall be at its option to repair or replace such EVM, or credit User's account for such EVM. TI's liability under this warranty shall be limited to EVMs that are returned during the warranty period to the address designated by TI and that are determined by TI not to conform to such warranty. If TI elects to repair or replace such EVM, TI shall have a reasonable time to repair such EVM or provide replacements. Repaired EVMs shall be warranted for the remainder of the original warranty period. Replaced EVMs shall be warranted for a new full ninety (90) day warranty period.
3. *Regulatory Notices:*
 - 3.1 *United States*
 - 3.1.1 *Notice applicable to EVMs not FCC-Approved:*

This kit is designed to allow product developers to evaluate electronic components, circuitry, or software associated with the kit to determine whether to incorporate such items in a finished product and software developers to write software applications for use with the end product. This kit is not a finished product and when assembled may not be resold or otherwise marketed unless all required FCC equipment authorizations are first obtained. Operation is subject to the condition that this product not cause harmful interference to licensed radio stations and that this product accept harmful interference. Unless the assembled kit is designed to operate under part 15, part 18 or part 95 of this chapter, the operator of the kit must operate under the authority of an FCC license holder or must secure an experimental authorization under part 5 of this chapter.
 - 3.1.2 *For EVMs annotated as FCC – FEDERAL COMMUNICATIONS COMMISSION Part 15 Compliant:*

CAUTION

This device complies with part 15 of the FCC Rules. Operation is subject to the following two conditions: (1) This device may not cause harmful interference, and (2) this device must accept any interference received, including interference that may cause undesired operation.

Changes or modifications not expressly approved by the party responsible for compliance could void the user's authority to operate the equipment.

FCC Interference Statement for Class A EVM devices

NOTE: This equipment has been tested and found to comply with the limits for a Class A digital device, pursuant to part 15 of the FCC Rules. These limits are designed to provide reasonable protection against harmful interference when the equipment is operated in a commercial environment. This equipment generates, uses, and can radiate radio frequency energy and, if not installed and used in accordance with the instruction manual, may cause harmful interference to radio communications. Operation of this equipment in a residential area is likely to cause harmful interference in which case the user will be required to correct the interference at his own expense.

FCC Interference Statement for Class B EVM devices

NOTE: This equipment has been tested and found to comply with the limits for a Class B digital device, pursuant to part 15 of the FCC Rules. These limits are designed to provide reasonable protection against harmful interference in a residential installation. This equipment generates, uses and can radiate radio frequency energy and, if not installed and used in accordance with the instructions, may cause harmful interference to radio communications. However, there is no guarantee that interference will not occur in a particular installation. If this equipment does cause harmful interference to radio or television reception, which can be determined by turning the equipment off and on, the user is encouraged to try to correct the interference by one or more of the following measures:

- Reorient or relocate the receiving antenna.
- Increase the separation between the equipment and receiver.
- Connect the equipment into an outlet on a circuit different from that to which the receiver is connected.
- Consult the dealer or an experienced radio/TV technician for help.

3.2 Canada

3.2.1 For EVMs issued with an Industry Canada Certificate of Conformance to RSS-210

Concerning EVMs Including Radio Transmitters:

This device complies with Industry Canada license-exempt RSS standard(s). Operation is subject to the following two conditions: (1) this device may not cause interference, and (2) this device must accept any interference, including interference that may cause undesired operation of the device.

Concernant les EVMs avec appareils radio:

Le présent appareil est conforme aux CNR d'Industrie Canada applicables aux appareils radio exempts de licence. L'exploitation est autorisée aux deux conditions suivantes: (1) l'appareil ne doit pas produire de brouillage, et (2) l'utilisateur de l'appareil doit accepter tout brouillage radioélectrique subi, même si le brouillage est susceptible d'en compromettre le fonctionnement.

Concerning EVMs Including Detachable Antennas:

Under Industry Canada regulations, this radio transmitter may only operate using an antenna of a type and maximum (or lesser) gain approved for the transmitter by Industry Canada. To reduce potential radio interference to other users, the antenna type and its gain should be so chosen that the equivalent isotropically radiated power (e.i.r.p.) is not more than that necessary for successful communication. This radio transmitter has been approved by Industry Canada to operate with the antenna types listed in the user guide with the maximum permissible gain and required antenna impedance for each antenna type indicated. Antenna types not included in this list, having a gain greater than the maximum gain indicated for that type, are strictly prohibited for use with this device.

Concernant les EVMs avec antennes détachables

Conformément à la réglementation d'Industrie Canada, le présent émetteur radio peut fonctionner avec une antenne d'un type et d'un gain maximal (ou inférieur) approuvé pour l'émetteur par Industrie Canada. Dans le but de réduire les risques de brouillage radioélectrique à l'intention des autres utilisateurs, il faut choisir le type d'antenne et son gain de sorte que la puissance isotrope rayonnée équivalente (p.i.r.e.) ne dépasse pas l'intensité nécessaire à l'établissement d'une communication satisfaisante. Le présent émetteur radio a été approuvé par Industrie Canada pour fonctionner avec les types d'antenne énumérés dans le manuel d'usage et ayant un gain admissible maximal et l'impédance requise pour chaque type d'antenne. Les types d'antenne non inclus dans cette liste, ou dont le gain est supérieur au gain maximal indiqué, sont strictement interdits pour l'exploitation de l'émetteur.

3.3 Japan

3.3.1 *Notice for EVMs delivered in Japan:* Please see http://www.tij.co.jp/lstds/ti_ja/general/eStore/notice_01.page 日本国内に輸入される評価用キット、ボードについては、次のところをご覧ください。
http://www.tij.co.jp/lstds/ti_ja/general/eStore/notice_01.page

3.3.2 *Notice for Users of EVMs Considered "Radio Frequency Products" in Japan:* EVMs entering Japan may not be certified by TI as conforming to Technical Regulations of Radio Law of Japan.

If User uses EVMs in Japan, not certified to Technical Regulations of Radio Law of Japan, User is required by Radio Law of Japan to follow the instructions below with respect to EVMs:

1. Use EVMs in a shielded room or any other test facility as defined in the notification #173 issued by Ministry of Internal Affairs and Communications on March 28, 2006, based on Sub-section 1.1 of Article 6 of the Ministry's Rule for Enforcement of Radio Law of Japan,
2. Use EVMs only after User obtains the license of Test Radio Station as provided in Radio Law of Japan with respect to EVMs, or
3. Use of EVMs only after User obtains the Technical Regulations Conformity Certification as provided in Radio Law of Japan with respect to EVMs. Also, do not transfer EVMs, unless User gives the same notice above to the transferee. Please note that if User does not follow the instructions above, User will be subject to penalties of Radio Law of Japan.

【無線電波を送信する製品の開発キットをお使いになる際の注意事項】 開発キットの中には技術基準適合証明を受けていないものがあります。技術適合証明を受けていないものご使用に際しては、電波法遵守のため、以下のいずれかの措置を取っていただく必要がありますのでご注意ください。

1. 電波法施行規則第6条第1項第1号に基づく平成18年3月28日総務省告示第173号で定められた電波暗室等の試験設備でご使用いただく。
2. 実験局の免許を取得後ご使用いただく。
3. 技術基準適合証明を取得後ご使用いただく。

なお、本製品は、上記の「ご使用にあたっての注意」を譲渡先、移転先に通知しない限り、譲渡、移転できないものとします。

上記を遵守頂けない場合は、電波法の罰則が適用される可能性があることをご留意ください。日本テキサス・インスツルメンツ株式会社
東京都新宿区西新宿 6 丁目 2 4 番 1 号
西新宿三井ビル

3.3.3 *Notice for EVMs for Power Line Communication:* Please see http://www.tij.co.jp/llds/ti_ja/general/eStore/notice_02.page
電力線搬送波通信についての開発キットをお使いになる際の注意事項については、次のところをご覧ください。http://www.tij.co.jp/llds/ti_ja/general/eStore/notice_02.page

4 *EVM Use Restrictions and Warnings:*

4.1 EVMS ARE NOT FOR USE IN FUNCTIONAL SAFETY AND/OR SAFETY CRITICAL EVALUATIONS, INCLUDING BUT NOT LIMITED TO EVALUATIONS OF LIFE SUPPORT APPLICATIONS.

4.2 User must read and apply the user guide and other available documentation provided by TI regarding the EVM prior to handling or using the EVM, including without limitation any warning or restriction notices. The notices contain important safety information related to, for example, temperatures and voltages.

4.3 *Safety-Related Warnings and Restrictions:*

4.3.1 User shall operate the EVM within TI's recommended specifications and environmental considerations stated in the user guide, other available documentation provided by TI, and any other applicable requirements and employ reasonable and customary safeguards. Exceeding the specified performance ratings and specifications (including but not limited to input and output voltage, current, power, and environmental ranges) for the EVM may cause personal injury or death, or property damage. If there are questions concerning performance ratings and specifications, User should contact a TI field representative prior to connecting interface electronics including input power and intended loads. Any loads applied outside of the specified output range may also result in unintended and/or inaccurate operation and/or possible permanent damage to the EVM and/or interface electronics. Please consult the EVM user guide prior to connecting any load to the EVM output. If there is uncertainty as to the load specification, please contact a TI field representative. During normal operation, even with the inputs and outputs kept within the specified allowable ranges, some circuit components may have elevated case temperatures. These components include but are not limited to linear regulators, switching transistors, pass transistors, current sense resistors, and heat sinks, which can be identified using the information in the associated documentation. When working with the EVM, please be aware that the EVM may become very warm.

4.3.2 EVMs are intended solely for use by technically qualified, professional electronics experts who are familiar with the dangers and application risks associated with handling electrical mechanical components, systems, and subsystems. User assumes all responsibility and liability for proper and safe handling and use of the EVM by User or its employees, affiliates, contractors or designees. User assumes all responsibility and liability to ensure that any interfaces (electronic and/or mechanical) between the EVM and any human body are designed with suitable isolation and means to safely limit accessible leakage currents to minimize the risk of electrical shock hazard. User assumes all responsibility and liability for any improper or unsafe handling or use of the EVM by User or its employees, affiliates, contractors or designees.

4.4 User assumes all responsibility and liability to determine whether the EVM is subject to any applicable international, federal, state, or local laws and regulations related to User's handling and use of the EVM and, if applicable, User assumes all responsibility and liability for compliance in all respects with such laws and regulations. User assumes all responsibility and liability for proper disposal and recycling of the EVM consistent with all applicable international, federal, state, and local requirements.

5. *Accuracy of Information:* To the extent TI provides information on the availability and function of EVMs, TI attempts to be as accurate as possible. However, TI does not warrant the accuracy of EVM descriptions, EVM availability or other information on its websites as accurate, complete, reliable, current, or error-free.

6. *Disclaimers:*
- 6.1 EXCEPT AS SET FORTH ABOVE, EVMS AND ANY WRITTEN DESIGN MATERIALS PROVIDED WITH THE EVM (AND THE DESIGN OF THE EVM ITSELF) ARE PROVIDED "AS IS" AND "WITH ALL FAULTS." TI DISCLAIMS ALL OTHER WARRANTIES, EXPRESS OR IMPLIED, REGARDING SUCH ITEMS, INCLUDING BUT NOT LIMITED TO ANY IMPLIED WARRANTIES OF MERCHANTABILITY OR FITNESS FOR A PARTICULAR PURPOSE OR NON-INFRINGEMENT OF ANY THIRD PARTY PATENTS, COPYRIGHTS, TRADE SECRETS OR OTHER INTELLECTUAL PROPERTY RIGHTS.
- 6.2 EXCEPT FOR THE LIMITED RIGHT TO USE THE EVM SET FORTH HEREIN, NOTHING IN THESE TERMS AND CONDITIONS SHALL BE CONSTRUED AS GRANTING OR CONFERRING ANY RIGHTS BY LICENSE, PATENT, OR ANY OTHER INDUSTRIAL OR INTELLECTUAL PROPERTY RIGHT OF TI, ITS SUPPLIERS/LICENSORS OR ANY OTHER THIRD PARTY, TO USE THE EVM IN ANY FINISHED END-USER OR READY-TO-USE FINAL PRODUCT, OR FOR ANY INVENTION, DISCOVERY OR IMPROVEMENT MADE, CONCEIVED OR ACQUIRED PRIOR TO OR AFTER DELIVERY OF THE EVM.
7. *USER'S INDEMNITY OBLIGATIONS AND REPRESENTATIONS.* USER WILL DEFEND, INDEMNIFY AND HOLD TI, ITS LICENSORS AND THEIR REPRESENTATIVES HARMLESS FROM AND AGAINST ANY AND ALL CLAIMS, DAMAGES, LOSSES, EXPENSES, COSTS AND LIABILITIES (COLLECTIVELY, "CLAIMS") ARISING OUT OF OR IN CONNECTION WITH ANY HANDLING OR USE OF THE EVM THAT IS NOT IN ACCORDANCE WITH THESE TERMS AND CONDITIONS. THIS OBLIGATION SHALL APPLY WHETHER CLAIMS ARISE UNDER STATUTE, REGULATION, OR THE LAW OF TORT, CONTRACT OR ANY OTHER LEGAL THEORY, AND EVEN IF THE EVM FAILS TO PERFORM AS DESCRIBED OR EXPECTED.
8. *Limitations on Damages and Liability:*
- 8.1 *General Limitations.* IN NO EVENT SHALL TI BE LIABLE FOR ANY SPECIAL, COLLATERAL, INDIRECT, PUNITIVE, INCIDENTAL, CONSEQUENTIAL, OR EXEMPLARY DAMAGES IN CONNECTION WITH OR ARISING OUT OF THESE TERMS AND CONDITIONS OR THE USE OF THE EVMS PROVIDED HEREUNDER, REGARDLESS OF WHETHER TI HAS BEEN ADVISED OF THE POSSIBILITY OF SUCH DAMAGES. EXCLUDED DAMAGES INCLUDE, BUT ARE NOT LIMITED TO, COST OF REMOVAL OR REINSTALLATION, ANCILLARY COSTS TO THE PROCUREMENT OF SUBSTITUTE GOODS OR SERVICES, RETESTING, OUTSIDE COMPUTER TIME, LABOR COSTS, LOSS OF GOODWILL, LOSS OF PROFITS, LOSS OF SAVINGS, LOSS OF USE, LOSS OF DATA, OR BUSINESS INTERRUPTION. NO CLAIM, SUIT OR ACTION SHALL BE BROUGHT AGAINST TI MORE THAN ONE YEAR AFTER THE RELATED CAUSE OF ACTION HAS OCCURRED.
- 8.2 *Specific Limitations.* IN NO EVENT SHALL TI'S AGGREGATE LIABILITY FROM ANY WARRANTY OR OTHER OBLIGATION ARISING OUT OF OR IN CONNECTION WITH THESE TERMS AND CONDITIONS, OR ANY USE OF ANY TI EVM PROVIDED HEREUNDER, EXCEED THE TOTAL AMOUNT PAID TO TI FOR THE PARTICULAR UNITS SOLD UNDER THESE TERMS AND CONDITIONS WITH RESPECT TO WHICH LOSSES OR DAMAGES ARE CLAIMED. THE EXISTENCE OF MORE THAN ONE CLAIM AGAINST THE PARTICULAR UNITS SOLD TO USER UNDER THESE TERMS AND CONDITIONS SHALL NOT ENLARGE OR EXTEND THIS LIMIT.
9. *Return Policy.* Except as otherwise provided, TI does not offer any refunds, returns, or exchanges. Furthermore, no return of EVM(s) will be accepted if the package has been opened and no return of the EVM(s) will be accepted if they are damaged or otherwise not in a resalable condition. If User feels it has been incorrectly charged for the EVM(s) it ordered or that delivery violates the applicable order, User should contact TI. All refunds will be made in full within thirty (30) working days from the return of the components(s), excluding any postage or packaging costs.
10. *Governing Law:* These terms and conditions shall be governed by and interpreted in accordance with the laws of the State of Texas, without reference to conflict-of-laws principles. User agrees that non-exclusive jurisdiction for any dispute arising out of or relating to these terms and conditions lies within courts located in the State of Texas and consents to venue in Dallas County, Texas. Notwithstanding the foregoing, any judgment may be enforced in any United States or foreign court, and TI may seek injunctive relief in any United States or foreign court.

Mailing Address: Texas Instruments, Post Office Box 655303, Dallas, Texas 75265
Copyright © 2015, Texas Instruments Incorporated

IMPORTANT NOTICE

Texas Instruments Incorporated and its subsidiaries (TI) reserve the right to make corrections, enhancements, improvements and other changes to its semiconductor products and services per JESD46, latest issue, and to discontinue any product or service per JESD48, latest issue. Buyers should obtain the latest relevant information before placing orders and should verify that such information is current and complete. All semiconductor products (also referred to herein as "components") are sold subject to TI's terms and conditions of sale supplied at the time of order acknowledgment.

TI warrants performance of its components to the specifications applicable at the time of sale, in accordance with the warranty in TI's terms and conditions of sale of semiconductor products. Testing and other quality control techniques are used to the extent TI deems necessary to support this warranty. Except where mandated by applicable law, testing of all parameters of each component is not necessarily performed.

TI assumes no liability for applications assistance or the design of Buyers' products. Buyers are responsible for their products and applications using TI components. To minimize the risks associated with Buyers' products and applications, Buyers should provide adequate design and operating safeguards.

TI does not warrant or represent that any license, either express or implied, is granted under any patent right, copyright, mask work right, or other intellectual property right relating to any combination, machine, or process in which TI components or services are used. Information published by TI regarding third-party products or services does not constitute a license to use such products or services or a warranty or endorsement thereof. Use of such information may require a license from a third party under the patents or other intellectual property of the third party, or a license from TI under the patents or other intellectual property of TI.

Reproduction of significant portions of TI information in TI data books or data sheets is permissible only if reproduction is without alteration and is accompanied by all associated warranties, conditions, limitations, and notices. TI is not responsible or liable for such altered documentation. Information of third parties may be subject to additional restrictions.

Resale of TI components or services with statements different from or beyond the parameters stated by TI for that component or service voids all express and any implied warranties for the associated TI component or service and is an unfair and deceptive business practice. TI is not responsible or liable for any such statements.

Buyer acknowledges and agrees that it is solely responsible for compliance with all legal, regulatory and safety-related requirements concerning its products, and any use of TI components in its applications, notwithstanding any applications-related information or support that may be provided by TI. Buyer represents and agrees that it has all the necessary expertise to create and implement safeguards which anticipate dangerous consequences of failures, monitor failures and their consequences, lessen the likelihood of failures that might cause harm and take appropriate remedial actions. Buyer will fully indemnify TI and its representatives against any damages arising out of the use of any TI components in safety-critical applications.

In some cases, TI components may be promoted specifically to facilitate safety-related applications. With such components, TI's goal is to help enable customers to design and create their own end-product solutions that meet applicable functional safety standards and requirements. Nonetheless, such components are subject to these terms.

No TI components are authorized for use in FDA Class III (or similar life-critical medical equipment) unless authorized officers of the parties have executed a special agreement specifically governing such use.

Only those TI components which TI has specifically designated as military grade or "enhanced plastic" are designed and intended for use in military/aerospace applications or environments. Buyer acknowledges and agrees that any military or aerospace use of TI components which have **not** been so designated is solely at the Buyer's risk, and that Buyer is solely responsible for compliance with all legal and regulatory requirements in connection with such use.

TI has specifically designated certain components as meeting ISO/TS16949 requirements, mainly for automotive use. In any case of use of non-designated products, TI will not be responsible for any failure to meet ISO/TS16949.

Products

Audio	www.ti.com/audio
Amplifiers	amplifier.ti.com
Data Converters	dataconverter.ti.com
DLP® Products	www.dlp.com
DSP	dsp.ti.com
Clocks and Timers	www.ti.com/clocks
Interface	interface.ti.com
Logic	logic.ti.com
Power Mgmt	power.ti.com
Microcontrollers	microcontroller.ti.com
RFID	www.ti-rfid.com
OMAP Applications Processors	www.ti.com/omap
Wireless Connectivity	www.ti.com/wirelessconnectivity

Applications

Automotive and Transportation	www.ti.com/automotive
Communications and Telecom	www.ti.com/communications
Computers and Peripherals	www.ti.com/computers
Consumer Electronics	www.ti.com/consumer-apps
Energy and Lighting	www.ti.com/energy
Industrial	www.ti.com/industrial
Medical	www.ti.com/medical
Security	www.ti.com/security
Space, Avionics and Defense	www.ti.com/space-avionics-defense
Video and Imaging	www.ti.com/video

TI E2E Community

e2e.ti.com