

# 16-Bit, 500kHz, MicroPower Sampling ANALOG-TO-DIGITAL CONVERTER

Check for Samples: [ADS8322](#)

## FEATURES

- HIGH-SPEED PARALLEL INTERFACE
- 500kHz SAMPLING RATE
- LOW POWER: 85mW at 500kHz
- INTERNAL 2.5V REFERENCE
- UNIPOLAR INPUT RANGE
- TQFP-32 PACKAGE

## APPLICATIONS

- CT SCANNERS
- HIGH-SPEED DATA ACQUISITION
- TEST AND INSTRUMENTATION
- MEDICAL EQUIPMENT

## DESCRIPTION

The ADS8322 is a 16-bit, 500kHz analog-to-digital (A/D) converter with an internal 2.5V reference. The device includes a 16-bit capacitor-based successive approximation register (SAR) A/D converter with inherent sample-and-hold. The ADS8322 offers a full 16-bit interface, or an 8-bit option where data are read using two read cycles and eight pins. The ADS8322 is available in a TQFP-32 package and is ensured over the industrial  $-40^{\circ}\text{C}$  to  $+85^{\circ}\text{C}$  temperature range.

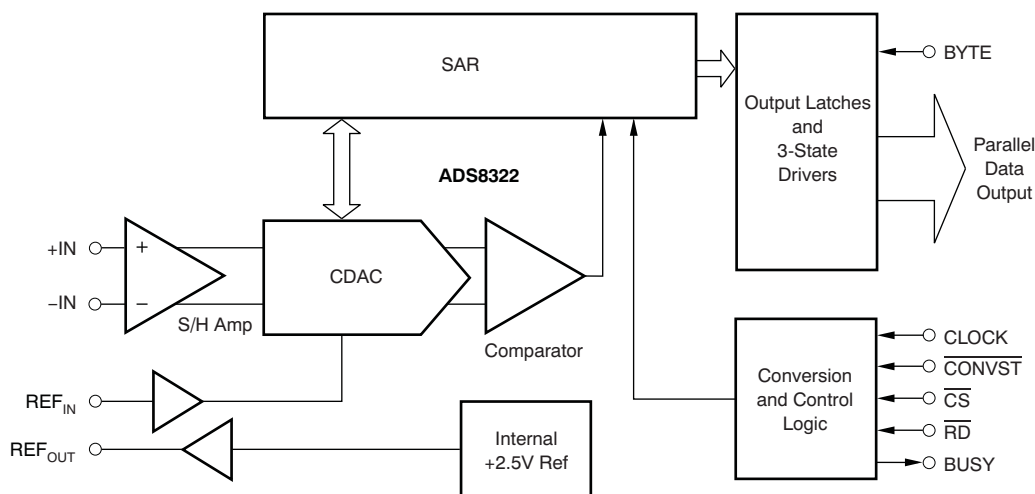

Please be aware that an important notice concerning availability, standard warranty, and use in critical applications of Texas Instruments semiconductor products and disclaimers thereto appears at the end of this data sheet.

All trademarks are the property of their respective owners.



This integrated circuit can be damaged by ESD. Texas Instruments recommends that all integrated circuits be handled with appropriate precautions. Failure to observe proper handling and installation procedures can cause damage.

ESD damage can range from subtle performance degradation to complete device failure. Precision integrated circuits may be more susceptible to damage because very small parametric changes could cause the device not to meet its published specifications.

**ORDERING INFORMATION<sup>(1)</sup>**

PRODUCT	MAXIMUM INTEGRAL LINEARITY ERROR (LSB)	NO MISSING CODES ERROR (LSB)	PACKAGE-LEAD	PACKAGE DESIGNATOR	SPECIFIED TEMPERATURE RANGE	PACKAGE MARKING	TRANSPORT MEDIA, QUANTITY
ADS8322Y	±8	14	TQFP-32	PBS	-40°C to +85°C		Tape and reel, 250
							Tape and reel, 2000
ADS8322YB	±6	15	TQFP-32	PBS	-40°C to +85°C		Tape and reel, 250
							Tape and reel, 2000

(1) For the most current package and ordering information, see the Package Option Addendum at the end of this data sheet, or see the TI website at [www.ti.com](http://www.ti.com).

**ABSOLUTE MAXIMUM RATINGS<sup>(1)</sup>**

Over operating free-air temperature range (unless otherwise noted).

	ADS8322	UNIT
+IN to GND	$V_A + 0.1$	V
-IN to GND	+0.5	V
$V_A$ to GND	-0.3 to +7	V
Digital input voltage to GND	-0.3 to ( $V_A + 0.3$ )	V
$V_{OUT}$ to GND	-0.3 to ( $V_A + 0.3$ )	V
Operating temperature range	-40 to +105	°C
Storage temperature range	-65 to +150	°C
Junction temperature ( $T_J$ max)	+150	°C
Power dissipation	$(T_J \text{ max} - T_A) / \theta_{JA}$	
$\theta_{JA}$ thermal impedance	240	°C/W

(1) Stresses above those listed under *Absolute Maximum Ratings* may cause permanent damage to the device. Exposure to absolute maximum conditions for extended periods may affect device reliability.

**ELECTRICAL CHARACTERISTICS: +V<sub>A</sub> = +5V**

 At –40°C to +85°C, +V<sub>A</sub> = +5V, V<sub>REF</sub> = +2.5V, f<sub>SAMPLE</sub> = 500kHz, and f<sub>CLK</sub> = 20 • f<sub>SAMPLE</sub>, unless otherwise specified.

PARAMETER	TEST CONDITIONS	ADS8322Y			ADS8322YB <sup>(1)</sup>			UNIT
		MIN	TYP	MAX	MIN	TYP	MAX	
<b>RESOLUTION</b>								
Resolution			16			16		Bits
<b>ANALOG INPUTS</b>								
Full-scale input span <sup>(2)</sup>	+IN – (–IN)	0		+2V <sub>REF</sub>	0		+2V <sub>REF</sub>	V
Absolute input range	+IN	–0.1		V <sub>A</sub> + 0.1	–0.1		V <sub>A</sub> + 0.1	V
	–IN	–0.1		+0.5	–0.1		+0.5	V
Capacitance			25			25		pF
Leakage current			±1			±1		nA
<b>SYSTEM PERFORMANCE</b>								
No missing codes		14			15			Bits
Integral linearity error			±4	±8		±3	±6	LSBs <sup>(3)</sup>
Offset error			±1.0	±2		±0.5	±1.0	mV
Gain error <sup>(4)</sup>			±0.25	±0.50		±0.22	±0.25	%FSR
Common-mode rejection ratio	At dc		70			70		dB
Noise			60			60		μV <sub>RMS</sub>
Power-supply rejection ratio	At FFFFh output code		±3			±3		LSBs
<b>SAMPLING DYNAMICS</b>								
Conversion time				1.6			1.6	μs
Acquisition time		350			350			ns
Throughput rate				500			500	kHz
Aperture delay			50			50		ns
Aperture jitter			20			20		ps
Small-signal bandwidth			30			30		MHz
Step response			100			100		ns
<b>DYNAMIC CHARACTERISTICS</b>								
Total harmonic distortion <sup>(5)</sup>	V <sub>IN</sub> = 5V <sub>PP</sub> at 100kHz		–90			–93		dB
SINAD	V <sub>IN</sub> = 5V <sub>PP</sub> at 100kHz		81			83		dB
Spurious free dynamic range	V <sub>IN</sub> = 5V <sub>PP</sub> at 100kHz		94			96		dB
<b>REFERENCE OUTPUT</b>								
Voltage	I <sub>OUT</sub> = 0	2.475	2.50	2.525	2.48	2.50	2.52	V
Source current	Static load			10			10	μA
Drift	I <sub>OUT</sub> = 0		20			20		ppm/°C
Line regulation	4.75V ≤ V <sub>CC</sub> ≤ 5.25V		0.6			0.6		mV
<b>REFERENCE INPUT</b>								
Range		1.5		2.55	1.5		2.55	V
Resistance <sup>(6)</sup>	To internal reference voltage		10			10		kΩ

(1) Shaded cells indicate different specifications from ADS8322Y.

(2) Ideal input span; does not include gain or offset error.

 (3) LSB means least significant bit, with V<sub>REF</sub> equal to +2.5V; 1LSB = 76μV.

(4) Measured relative to an ideal, full-scale input [+In – (–In)] of 4.9999V. Thus, gain error includes the error of the internal voltage reference.

(5) Calculated on the first nine harmonics of the input frequency.

(6) Can vary ±30%.

**ELECTRICAL CHARACTERISTICS: +V<sub>A</sub> = +5V (continued)**

At -40°C to +85°C, +V<sub>A</sub> = +5V, V<sub>REF</sub> = +2.5V, f<sub>SAMPLE</sub> = 500kHz, and f<sub>CLK</sub> = 20 • f<sub>SAMPLE</sub>, unless otherwise specified.

PARAMETER	TEST CONDITIONS	ADS8322Y			ADS8322YB <sup>(1)</sup>			UNIT
		MIN	TYP	MAX	MIN	TYP	MAX	
<b>DIGITAL INPUT/OUTPUT</b>								
Logic family			CMOS			CMOS		
Logic levels:								
V <sub>IH</sub>	I <sub>IH</sub> ≤ +5μA	3.0		+V <sub>A</sub>	3.0		+V <sub>A</sub>	V
V <sub>IL</sub>	I <sub>IL</sub> ≤ +5μA	-0.3		0.8	-0.3		0.8	V
V <sub>OH</sub>	I <sub>OH</sub> = 2 TTL Loads	4.0			4.0			V
V <sub>OL</sub>	I <sub>OH</sub> = 2 TTL Loads			0.4			0.4	V
Data format		Straight binary			Straight binary			
<b>POWER-SUPPLY REQUIREMENTS</b>								
Power-supply voltage								
+V <sub>A</sub>		4.75	5	5.25	4.75	5	5.25	V
+V <sub>D</sub>		4.75	5	5.25	4.75	5	5.25	V
Supply current	f <sub>SAMPLE</sub> = 500kHz		17	25		17	25	mA
Power dissipation	f <sub>SAMPLE</sub> = 500kHz		85	125		85	125	mW
<b>TEMPERATURE RANGE</b>								
Specified temperature range		-40		+85	-40		+85	°C

**DEVICE INFORMATION**

**PBS PACKAGE  
TQFP-32  
(TOP VIEW)**

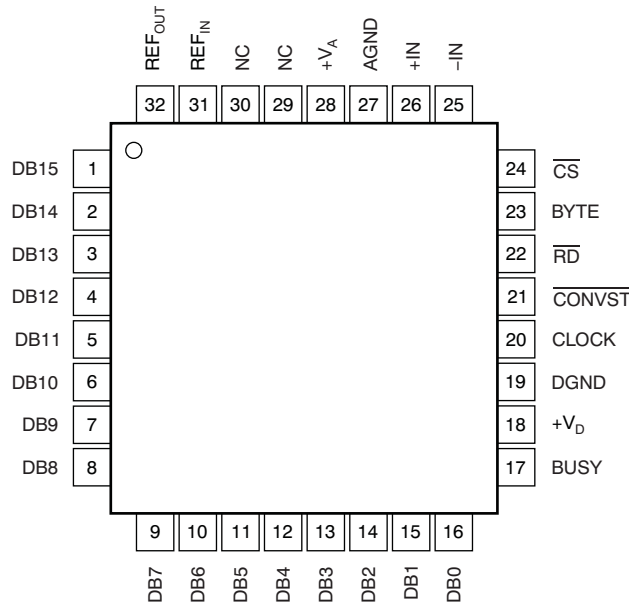

**PIN ASSIGNMENTS**

TERMINAL		DESCRIPTION
NO	NAME	
1	DB15	Data Bit 15 (MSB)
2	DB14	Data Bit 14
3	DB13	Data Bit 13
4	DB12	Data Bit 12
5	DB11	Data Bit 11
6	DB10	Data Bit 10
7	DB9	Data Bit 9
8	DB8	Data Bit 8
9	DB7	Data Bit 7
10	DB6	Data Bit 6
11	DB5	Data Bit 5
12	DB4	Data Bit 4
13	DB3	Data Bit 3
14	DB2	Data Bit 2
15	DB1	Data Bit 1
16	DB0	Data Bit 0 (LSB)
17	BUSY	High when a conversion is in progress.
18	V <sub>D+</sub>	Digital Power Supply, +5VDC.
19	DGND	Digital Ground
20	CLOCK	An external CMOS-compatible clock can be applied to the CLOCK input to synchronize the conversion process to an external source.
21	$\overline{\text{CONVST}}$	Convert Start
22	$\overline{\text{RD}}$	Synchronization pulse for the parallel output.
23	BYTE	Selects eight most significant bits (low) or eight least significant bits (high). Data valid on pins 9-16.
24	$\overline{\text{CS}}$	Chip Select
25	-IN	Inverting Input Channel
26	+IN	Noninverting Input Channel
27	AGND	Analog Ground
28	+V <sub>A</sub>	Analog Power Supply, +5VDC.
29	NC	No connection
30	NC	No connection
31	REF <sub>IN</sub>	Reference Input. When using the internal 2.5V reference, tie this pin directly to REF <sub>OUT</sub> .
32	REF <sub>OUT</sub>	Reference Output. A 0.1μF capacitor should be connected to this pin when the internal reference is used.

**TIMING INFORMATION**

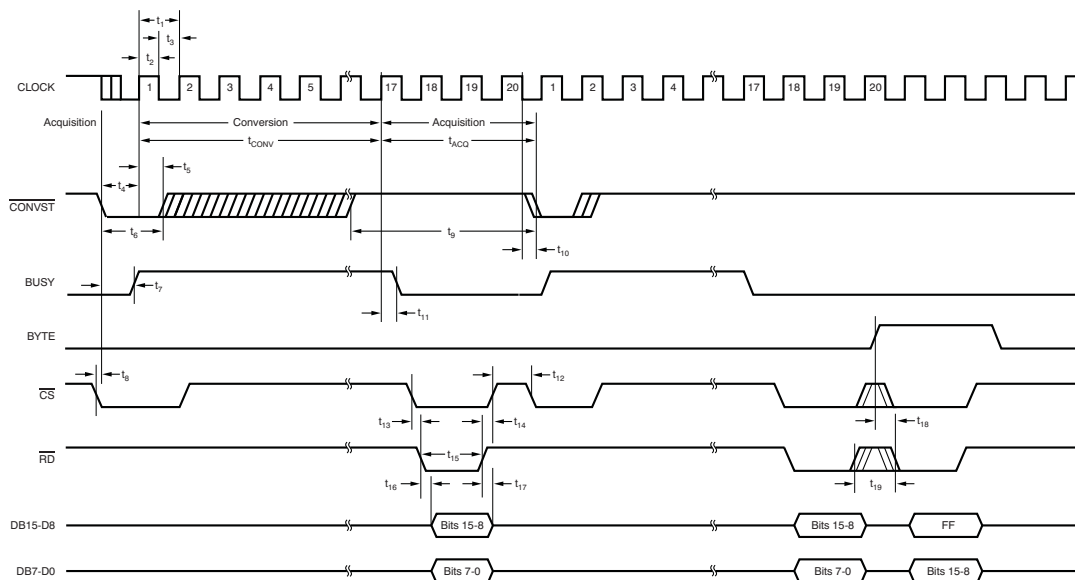

**TIMING CHARACTERISTICS<sup>(1)(2)</sup>**

All specifications typical at  $-40^{\circ}\text{C}$  to  $+85^{\circ}\text{C}$ ,  $+V_D = +5\text{V}$ .

PARAMETER	TEST CONDITIONS	ADS8322			UNIT
		MIN	TYP	MAX	
$t_{\text{CONV}}$	Conversion Time			1.6	$\mu\text{s}$
$t_{\text{AQC}}$	Acquisition Time	350			ns
$t_1$	CLOCK Period	100			ns
$t_2$	CLOCK High Time	40			ns
$t_3$	CLOCK Low Time	40			ns
$t_4$	$\overline{\text{CONVST}}$ Low to Clock High	10			ns
$t_5$	CLOCK High to $\overline{\text{CONVST}}$ High	5			ns
$t_6$	$\overline{\text{CONVST}}$ Low Time	20			ns
$t_7$	$\overline{\text{CONVST}}$ Low to BUSY High			25	ns
$t_8$	$\overline{\text{CS}}$ Low to $\overline{\text{CONVST}}$ Low	0			ns
$t_9$	$\overline{\text{CONVST}}$ High	20			ns
$t_{10}$	CLOCK Low to $\overline{\text{CONVST}}$ Low	0			ns
$t_{11}$	CLOCK High to BUSY Low			25	ns
$t_{12}$	$\overline{\text{CS}}$ High	0			ns
$t_{13}$	$\overline{\text{CS}}$ Low to $\overline{\text{RD}}$ Low	0			ns
$t_{14}$	$\overline{\text{RD}}$ High to $\overline{\text{CS}}$ High	0			ns
$t_{15}$	$\overline{\text{RD}}$ Low Time	50			ns
$t_{16}$	$\overline{\text{RD}}$ Low to Data Valid	40			ns
$t_{17}$	Data Hold from $\overline{\text{RD}}$ High	5			ns
$t_{18}$	BYTE Change to $\overline{\text{RD}}$ Low <sup>(3)</sup>	0			ns
$t_{19}$	$\overline{\text{RD}}$ High Time	20			ns

- (1) All input signals are specified with  $t_R = t_F = 5\text{ns}$  (10% to 90% of  $V_{DD}$ ) and timed from a voltage level of  $(V_{IL} + V_{IH}) / 2$ .
- (2) See timing diagram, above.
- (3) BYTE is asynchronous; when BYTE is 0, bits 15 through 0 appear at DB15-DB0. When BUSY is 1, bits 15 through 8 appear on DB7-DB0.  $\overline{\text{RD}}$  may remain low between changes in BYTE.

### TYPICAL CHARACTERISTICS

At  $-40^{\circ}\text{C}$  to  $+85^{\circ}\text{C}$ ,  $+V_A = +5\text{V}$ ,  $V_{\text{REF}} = +2.5\text{V}$ ,  $f_{\text{SAMPLE}} = 500\text{kHz}$ , and  $f_{\text{CLK}} = 20 \cdot f_{\text{SAMPLE}}$ , unless otherwise specified.

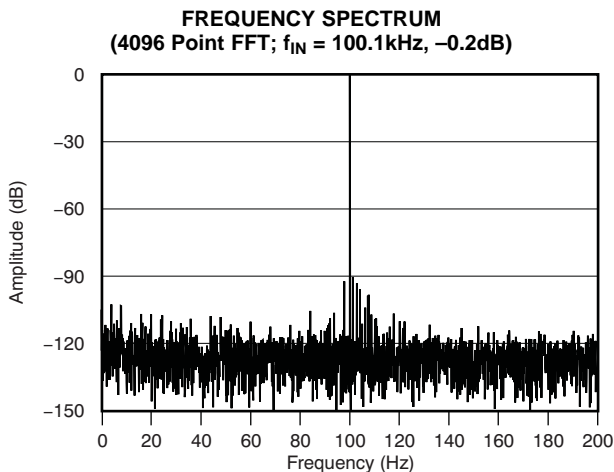

Figure 1.

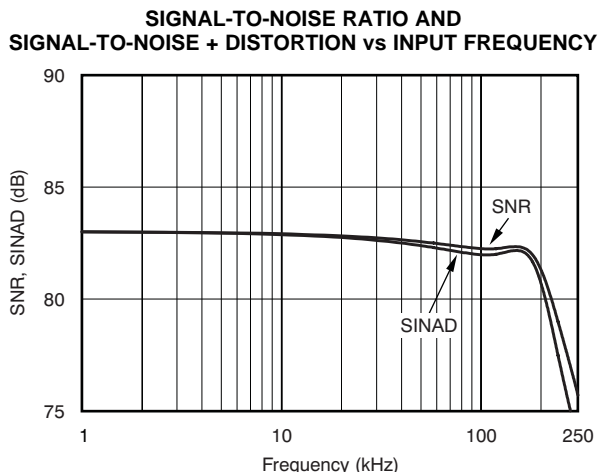

Figure 2.

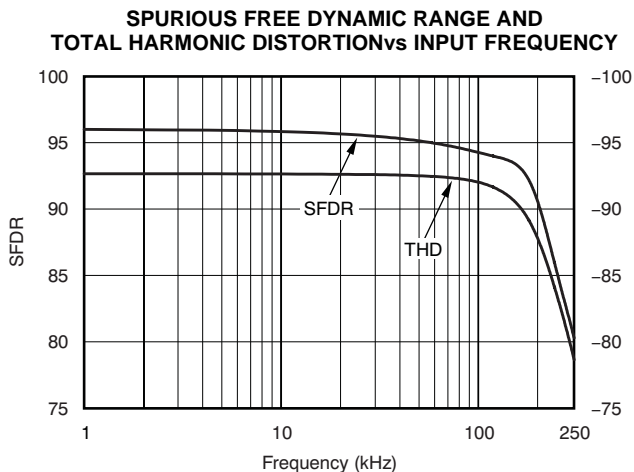

Figure 3.

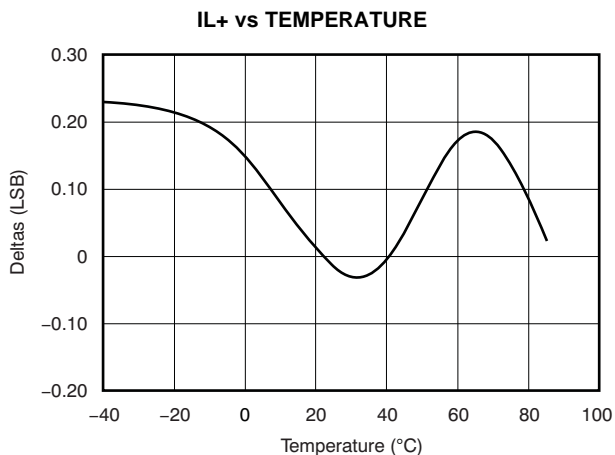

Figure 4.

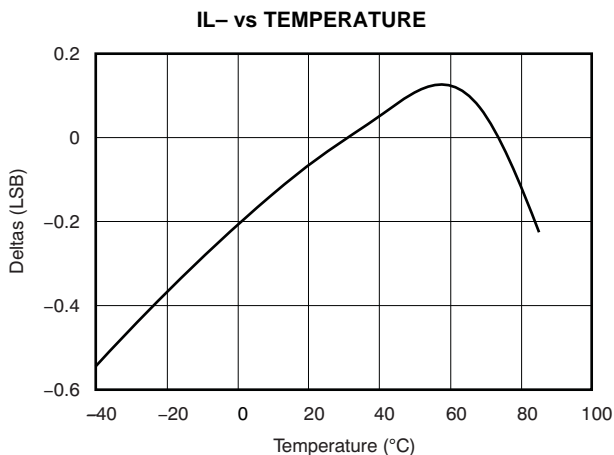

Figure 5.

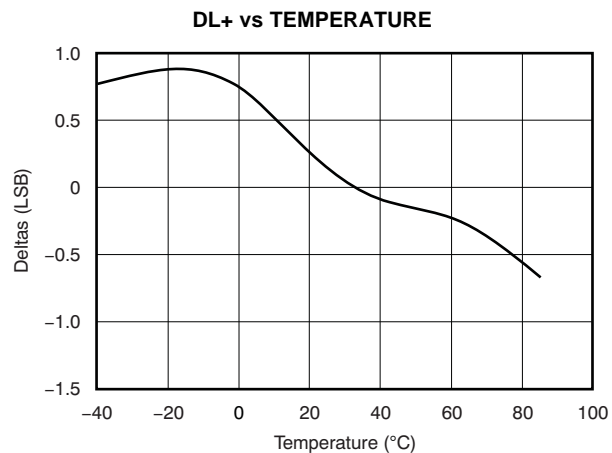
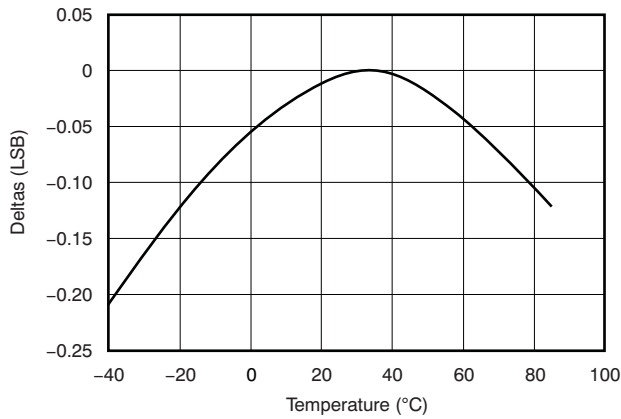

Figure 6.

**TYPICAL CHARACTERISTICS (continued)**

At  $-40^{\circ}\text{C}$  to  $+85^{\circ}\text{C}$ ,  $+V_A = +5\text{V}$ ,  $V_{\text{REF}} = +2.5\text{V}$ ,  $f_{\text{SAMPLE}} = 500\text{kHz}$ , and  $f_{\text{CLK}} = 20 \cdot f_{\text{SAMPLE}}$ , unless otherwise specified.

**DL- vs TEMPERATURE**



**Figure 7.**

**OFFSET ERROR vs TEMPERATURE**

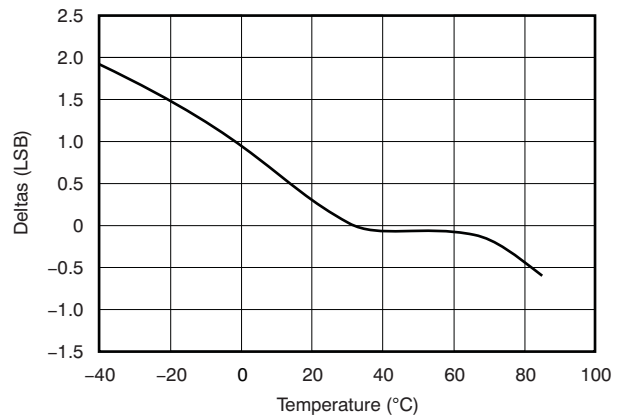

**Figure 8.**

**GAIN ERROR vs TEMPERATURE**

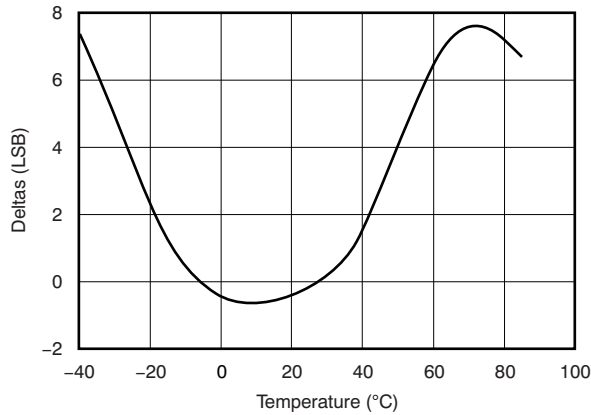

**Figure 9.**

**V<sub>REF</sub> vs TEMPERATURE**

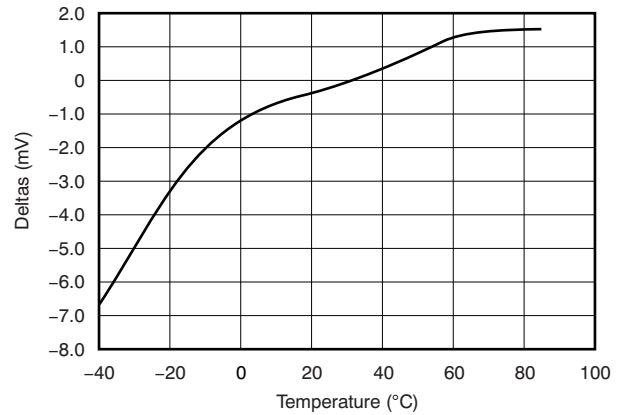

**Figure 10.**

**I<sub>Q</sub> vs TEMPERATURE**

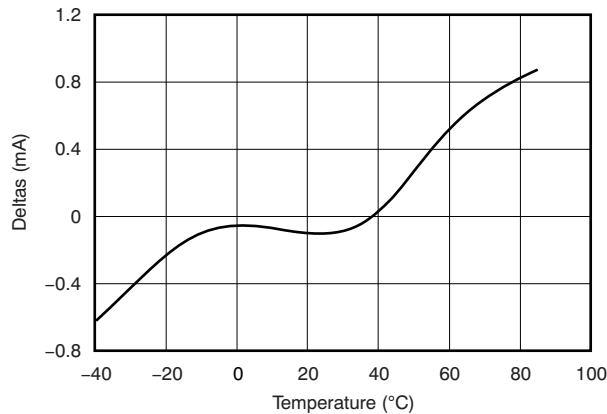

**Figure 11.**

**LINEARITY ERROR AND DIFFERENTIAL LINEARITY ERROR vs CODE**

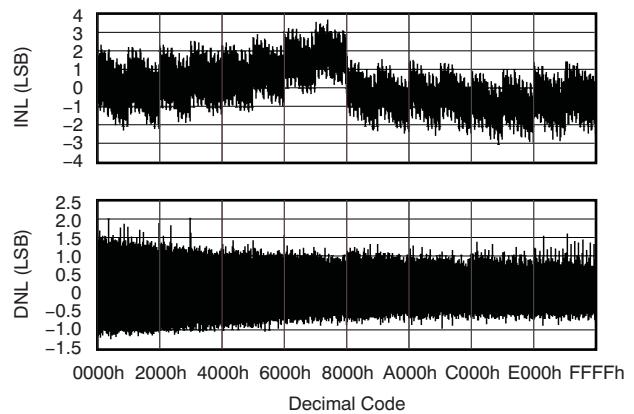

**Figure 12.**



### THEORY OF OPERATION

The ADS8322 is a high-speed successive approximation register (SAR) A/D converter with an internal 2.5V bandgap reference. The architecture is based on capacitive redistribution, which inherently includes a sample-and-hold function. The basic operating circuit for the ADS8322 is shown in Figure 13.

The ADS8322 requires an external clock to run the conversion process. The clock can be run continuously or it can be gated to conserve power between conversions. This clock can vary between 25kHz (1.25kHz throughput) and 10MHz (500kHz throughput). The duty cycle of the clock is unimportant as long as the minimum HIGH and LOW

times are at least 40ns and the clock period is at least 100ns. The minimum clock frequency is governed by the parasitic leakage of the capacitive digital-to-analog (CDAC) capacitors internal to the ADS8322.

The analog input is provided to two input pins, +IN and -IN. When a conversion is initiated, the differential input on these pins is sampled on the internal capacitor array. While a conversion is in progress, both inputs are disconnected from any internal function.

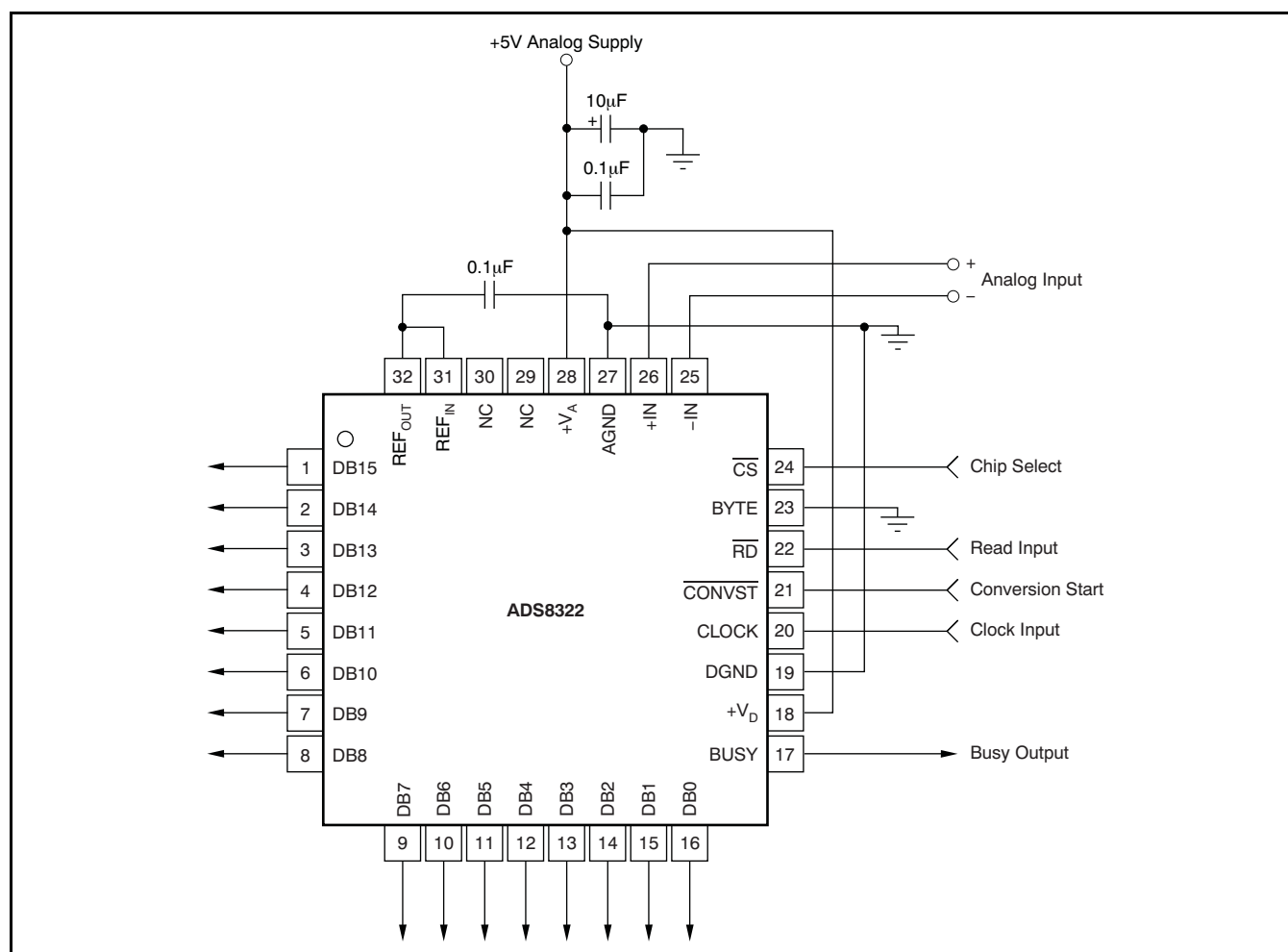

Figure 13. Typical Circuit Configuration

## REFERENCE

Under normal operation, the REF<sub>OUT</sub> pin should be directly connected to the REF<sub>IN</sub> pin to provide an internal +2.5V reference to the ADS8322. The ADS8322 can operate, however, with an external reference in the range of 1.5V to 2.6V for a corresponding full-scale range of 3.0V to 5.2V.

The internal reference of the ADS8322 is double-buffered. If the internal reference is used to drive an external load, a buffer is provided between the reference and the load applied to the REF<sub>OUT</sub> pin (the internal reference can typically source and sink 10µA of current). If an external reference is used, the second buffer provides isolation between the external reference and the CDAC. This buffer is also used to recharge all of the CDAC capacitors during conversion.

## ANALOG INPUT

When the converter enters the Hold mode, the voltage difference between the +IN and –IN inputs is captured on the internal capacitor array. The voltage on the –IN input is limited between –0.1V and 0.5V, allowing the input to reject small signals which are common to both the +IN and –IN inputs. The +IN input has a range of –0.1V to +V<sub>A</sub> + 0.1V.

The input current on the analog inputs depends upon a number of factors: sample rate, input voltage, and source impedance. Essentially, the current into the ADS8322 charges the internal capacitor array during the sample period. After this capacitance has been fully charged, there is no further input current. The source of the analog input voltage must be able to charge the input capacitance (25pF) to a 16-bit settling level within the acquisition time (400ns) of the device. When the converter goes into Hold mode, the input impedance is greater than 1GΩ.

Care must be taken regarding the absolute analog input voltage. To maintain the linearity of the converter, the –IN input should not drop below GND – 100mV or exceed GND + 0.5V. The +IN input should always remain within the range of GND – 100mV to V<sub>A</sub> + 100mV. Outside of these ranges, the converter linearity may not meet specifications. To minimize noise, low-bandwidth input signals with low-pass filters should be used.

## DIGITAL INTERFACE

### TIMING AND CONTROL

See the [timing diagram](#) and the [Timing Characteristics](#) section for detailed information on timing signals and the respective requirements for each.

The ADS8322 uses an external clock (CLOCK) which controls the conversion rate of the CDAC. With a 10MHz external clock, the A/D converter sampling rate is 500kHz, which corresponds to a 2µs maximum throughput time.

Conversions are initiated by bringing the CONVST pin low for a minimum of 20ns (after the 20ns minimum requirement has been met, the CONVST pin can be brought high), while CS is low. The ADS8322 switches from Sample-to-Hold mode on the falling edge of the CONVST command. Following the first rising edge of the external clock after a CONVST low, the ADS8322 begins conversion (this first rising edge of the external clock represents the start of clock cycle one; the ADS8322 requires 16 rising clock edges to complete a conversion). The BUSY output goes high immediately following CONVST going low. BUSY stays high through the conversion process and returns low when the conversion has ended.

Both RD and CS can be high during and before a conversion (although CS must be low when CONVST goes low to initiate a conversion). Both the RD and CS pins are brought low in order to enable the parallel output bus with the conversion.

### READING DATA

The ADS8322 outputs full parallel data in Straight Binary format, as shown in [Table 1](#). The parallel output is active when CS and RD are both LOW. The output data should not be read 125ns before the falling edge of CONVST and 10ns after the falling edge. Any other combination of CS and RD will 3-state the parallel output. Refer to [Table 1](#) for ideal output codes.

**Table 1. Ideal Input Voltages and Output Codes**

DESCRIPTION	ANALOG VALUE	DIGITAL OUTPUT STRAIGHT BINARY	
		BINARY CODE	HEX CODE
Full-Scale Range	$2 \cdot V_{REF}$		
Least Significant Bit (LSB)	$2 \cdot V_{REF}/65535$		
+Full Scale	$2V_{REF} - 1 \text{ LSB}$	1111 1111 1111 1111	FFFF
Midscale	$V_{REF}$	1000 0000 0000 0000	8000
Midscale – LSB	$V_{REF} - 1 \text{ LSB}$	0111 1111 1111 1111	7FFF
Zero	0	0000 0000 0000 0000	0000

## BYTE

The output data appear as a full 16-bit word on DB15- DB0 (MSB-LSB), if BYTE is low. The result may also be read on an 8-bit bus by using only DB7-DB0. In this case two reads are necessary. The first read proceeds as before, leaving BYTE low and reading the eight least significant bits on DB7-DB0, then bringing BYTE high. When BYTE is high, the upper eight bits (D15-D8) appear on DB7-DB0.

## NOISE

Figure 14 shows the transition noise of the ADS8322. A low-level dc input was applied to the analog input pins and the converter was put through 8,192 conversions. The digital output of the A/D converter varies in output code due to the internal noise of the ADS8322. This characteristic is true for all 16-bit SAR-type A/D converters. Using a histogram to plot the output codes, the distribution should appear bell-shaped, with the peak of the bell curve representing the nominal code for the input value. The  $\pm 1\sigma$ ,  $\pm 2\sigma$ , and  $\pm 3\sigma$  distributions respectively represent the 68.3%, 95.5%, and 99.7% of all codes. The transition noise can be calculated by dividing the number of codes measured by six; this yields the  $\pm 3\sigma$  distribution, or 99.7%, of all codes. Statistically, up to three codes could fall outside the distribution when executing 1,000 conversions. The ADS8322, with five output codes for the  $\pm 3\sigma$  distribution, yields a  $< \pm 0.8\text{LSB}$  transition noise at 5V operation. Remember that to achieve this low-noise performance, the peak-to-peak noise of the input signal and reference must be  $< 50\mu\text{V}$ .

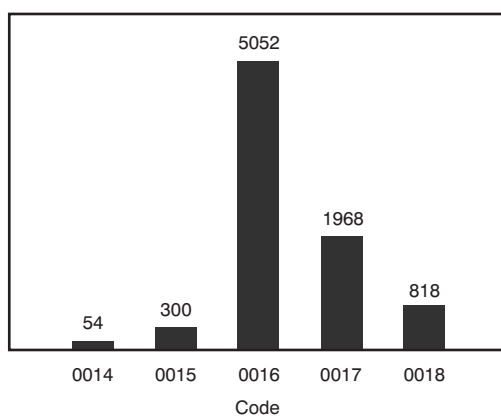

**Figure 14. Histogram of 8,192 Conversions of a Low-Level DC Input**

## AVERAGING

The noise of the A/D converter can be compensated by averaging the digital codes. By averaging conversion results, transition noise is reduced by a factor of  $1/\sqrt{n}$ , where  $n$  is the number of averages. For example, averaging four conversion results reduces the transition noise by 1/2 to  $\pm 0.25\text{LSBs}$ . Averaging should only be used for input signals with frequencies near dc.

For ac signals, a digital filter can be used to low-pass filter and decimate the output codes. This configuration works in a similar manner to averaging: for every decimation by 2, the signal-to-noise ratio improves by 3dB.

## LAYOUT

For optimum performance, care should be taken with the physical layout of the ADS8322 circuitry. This consideration is particularly true if the CLOCK input is approaching the maximum throughput rate.

As the ADS8322 offers single-supply operation, it is often used in close proximity with digital logic, microcontrollers, microprocessors, and digital signal processors. The more digital logic present in the design and the higher the switching speed, the more difficult it is to achieve good performance from the converter.

The basic SAR architecture is sensitive to glitches or sudden changes on the power supply, reference, ground connections and digital inputs that occur just before latching the output of the analog comparator. Thus, during any single conversion for an  $n$ -bit SAR converter, there are  $n$  windows in which large external transient voltages can affect the conversion result. Such glitches might originate from switching power supplies, or nearby digital logic or high-power devices.

The degree of error in the digital output depends on the reference voltage, layout, and the exact timing of the external event. These errors can change if the external event changes in time with respect to the CLOCK input.

On average, the ADS8322 draws very little current from an external reference, as the reference voltage is internally buffered. If the reference voltage is external and originates from an op amp, make sure that it can drive the bypass capacitor or capacitors without oscillation.

The AGND and DGND pins should be connected to a clean ground point. In all cases, this point should be the *analog* ground. Avoid connections which are too close to the grounding point of a microcontroller or digital signal processor. If required, run a ground trace directly from the converter to the power supply entry point. The ideal layout will include an analog ground plane dedicated to the converter and associated analog circuitry.

As with the GND connections,  $V_{DD}$  should be connected to a +5V power supply plane, or trace, that is separate from the connection for digital logic until they are connected at the power entry point. Power to the ADS8322 should be clean and well-bypassed. A 0.1 $\mu$ F ceramic bypass capacitor should be placed as close to the device as possible. In addition, a 1 $\mu$ F to 10 $\mu$ F capacitor is recommended. If needed, an even larger capacitor and a 5 $\Omega$  or 10 $\Omega$  series resistor may be used to low-pass filter a noisy supply. In some situations, additional bypassing may be required, such as a 100 $\mu$ F electrolytic capacitor, or even a *Pi* filter made up of inductors and capacitors—all designed to essentially low-pass filter the +5V supply, removing the high-frequency noise.

---

### REVISION HISTORY

NOTE: Page numbers for previous revisions may differ from page numbers in the current version.

Changes from Original (July, 2001) to Revision A	Page
• Updated document format to current standards .....	1
• Deleted <i>lead temperature</i> specifications from Absolute Maximum Ratings table .....	2
• Changed acquisition time specification from .4 $\mu$ s (max) to 350ns (min) .....	3
• Changed acquisition time specification from .4 $\mu$ s (max) to 350ns (min) .....	6
• Added <a href="#">Figure 12</a> , <i>Linearity Error and Differential Linearity Error vs Code</i> .....	8

**PACKAGING INFORMATION**

Orderable Device	Status (1)	Package Type	Package Drawing	Pins	Package Qty	Eco Plan (2)	Lead/Ball Finish (6)	MSL Peak Temp (3)	Op Temp (°C)	Device Marking (4/5)	Samples
ADS8322Y/250	ACTIVE	TQFP	PBS	32	250	Green (RoHS & no Sb/Br)	NIPDAU	Level-3-260C-168 HR	-40 to 85	B22Y	<a href="#">Samples</a>
ADS8322Y/2K	ACTIVE	TQFP	PBS	32	2000	Green (RoHS & no Sb/Br)	NIPDAU	Level-3-260C-168 HR	-40 to 85	B22Y	<a href="#">Samples</a>
ADS8322YB/250	ACTIVE	TQFP	PBS	32	250	Green (RoHS & no Sb/Br)	NIPDAU	Level-3-260C-168 HR	-40 to 85	B22Y B	<a href="#">Samples</a>

(1) The marketing status values are defined as follows:

**ACTIVE:** Product device recommended for new designs.

**LIFEBUY:** TI has announced that the device will be discontinued, and a lifetime-buy period is in effect.

**NRND:** Not recommended for new designs. Device is in production to support existing customers, but TI does not recommend using this part in a new design.

**PREVIEW:** Device has been announced but is not in production. Samples may or may not be available.

**OBsolete:** TI has discontinued the production of the device.

(2) **RoHS:** TI defines "RoHS" to mean semiconductor products that are compliant with the current EU RoHS requirements for all 10 RoHS substances, including the requirement that RoHS substance do not exceed 0.1% by weight in homogeneous materials. Where designed to be soldered at high temperatures, "RoHS" products are suitable for use in specified lead-free processes. TI may reference these types of products as "Pb-Free".

**RoHS Exempt:** TI defines "RoHS Exempt" to mean products that contain lead but are compliant with EU RoHS pursuant to a specific EU RoHS exemption.

**Green:** TI defines "Green" to mean the content of Chlorine (Cl) and Bromine (Br) based flame retardants meet JS709B low halogen requirements of <=1000ppm threshold. Antimony trioxide based flame retardants must also meet the <=1000ppm threshold requirement.

(3) MSL, Peak Temp. - The Moisture Sensitivity Level rating according to the JEDEC industry standard classifications, and peak solder temperature.

(4) There may be additional marking, which relates to the logo, the lot trace code information, or the environmental category on the device.

(5) Multiple Device Markings will be inside parentheses. Only one Device Marking contained in parentheses and separated by a "-" will appear on a device. If a line is indented then it is a continuation of the previous line and the two combined represent the entire Device Marking for that device.

(6) Lead/Ball Finish - Orderable Devices may have multiple material finish options. Finish options are separated by a vertical ruled line. Lead/Ball Finish values may wrap to two lines if the finish value exceeds the maximum column width.

**Important Information and Disclaimer:** The information provided on this page represents TI's knowledge and belief as of the date that it is provided. TI bases its knowledge and belief on information provided by third parties, and makes no representation or warranty as to the accuracy of such information. Efforts are underway to better integrate information from third parties. TI has taken and continues to take reasonable steps to provide representative and accurate information but may not have conducted destructive testing or chemical analysis on incoming materials and chemicals. TI and TI suppliers consider certain information to be proprietary, and thus CAS numbers and other limited information may not be available for release.

In no event shall TI's liability arising out of such information exceed the total purchase price of the TI part(s) at issue in this document sold by TI to Customer on an annual basis.

## TAPE AND REEL INFORMATION



### QUADRANT ASSIGNMENTS FOR PIN 1 ORIENTATION IN TAPE



\*All dimensions are nominal

Device	Package Type	Package Drawing	Pins	SPQ	Reel Diameter (mm)	Reel Width W1 (mm)	A0 (mm)	B0 (mm)	K0 (mm)	P1 (mm)	W (mm)	Pin1 Quadrant
ADS8322Y/250	TQFP	PBS	32	250	180.0	16.4	7.2	7.2	1.5	12.0	16.0	Q2
ADS8322Y/2K	TQFP	PBS	32	2000	330.0	16.4	7.2	7.2	1.5	12.0	16.0	Q2
ADS8322YB/250	TQFP	PBS	32	250	180.0	16.4	7.2	7.2	1.5	12.0	16.0	Q2

## TAPE AND REEL BOX DIMENSIONS



\*All dimensions are nominal

Device	Package Type	Package Drawing	Pins	SPQ	Length (mm)	Width (mm)	Height (mm)
ADS8322Y/250	TQFP	PBS	32	250	213.0	191.0	55.0
ADS8322Y/2K	TQFP	PBS	32	2000	350.0	350.0	43.0
ADS8322YB/250	TQFP	PBS	32	250	213.0	191.0	55.0



PBS (S-PQFP-G32)

PLASTIC QUAD FLATPACK

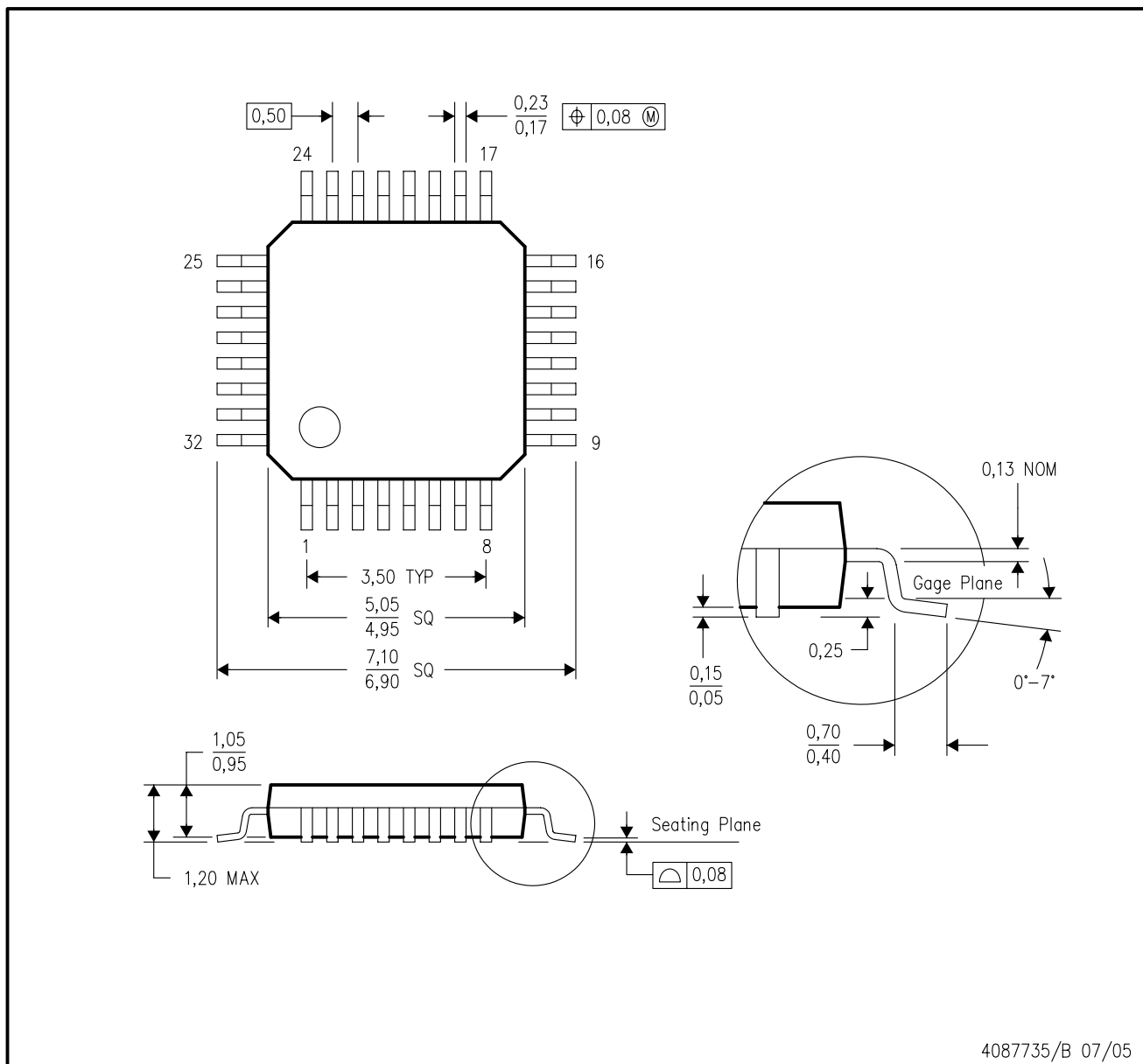

- NOTES:
- A. All linear dimensions are in millimeters.
  - B. This drawing is subject to change without notice.

PBS (S-PQFP-G32)

PLASTIC QUAD FLATPACK

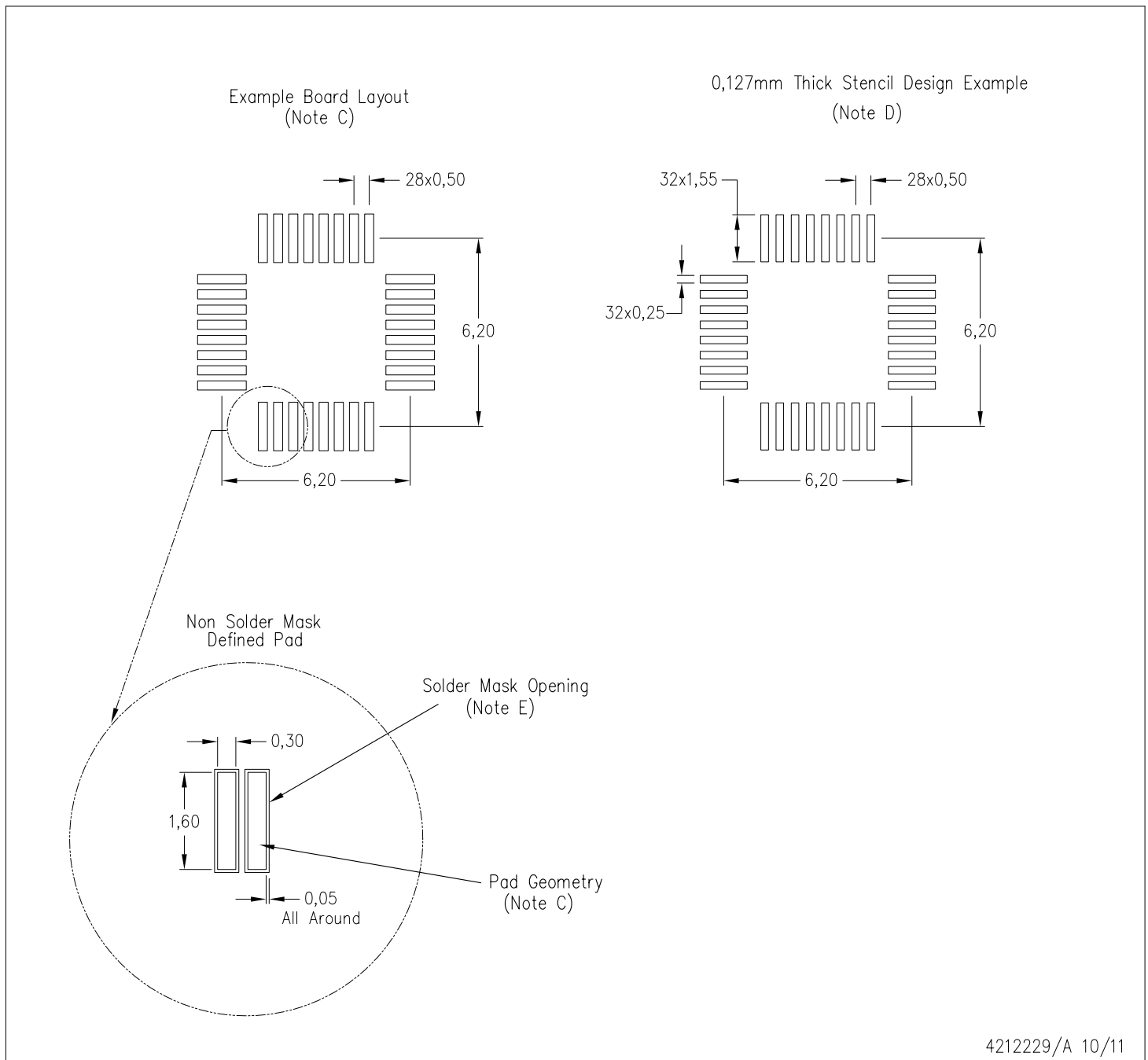

- NOTES:
- A. All linear dimensions are in millimeters.
  - B. This drawing is subject to change without notice.
  - C. Publication IPC-7351 is recommended for alternate designs.
  - D. Laser cutting apertures with trapezoidal walls and also rounding corners will offer better paste release. Customers should contact their board assembly site for stencil design recommendations. Refer to IPC 7525 for stencil design considerations.
  - E. Customers should contact their board fabrication site for recommended solder mask tolerances between and around signal pads.

## IMPORTANT NOTICE AND DISCLAIMER

TI PROVIDES TECHNICAL AND RELIABILITY DATA (INCLUDING DATASHEETS), DESIGN RESOURCES (INCLUDING REFERENCE DESIGNS), APPLICATION OR OTHER DESIGN ADVICE, WEB TOOLS, SAFETY INFORMATION, AND OTHER RESOURCES "AS IS" AND WITH ALL FAULTS, AND DISCLAIMS ALL WARRANTIES, EXPRESS AND IMPLIED, INCLUDING WITHOUT LIMITATION ANY IMPLIED WARRANTIES OF MERCHANTABILITY, FITNESS FOR A PARTICULAR PURPOSE OR NON-INFRINGEMENT OF THIRD PARTY INTELLECTUAL PROPERTY RIGHTS.

These resources are intended for skilled developers designing with TI products. You are solely responsible for (1) selecting the appropriate TI products for your application, (2) designing, validating and testing your application, and (3) ensuring your application meets applicable standards, and any other safety, security, or other requirements. These resources are subject to change without notice. TI grants you permission to use these resources only for development of an application that uses the TI products described in the resource. Other reproduction and display of these resources is prohibited. No license is granted to any other TI intellectual property right or to any third party intellectual property right. TI disclaims responsibility for, and you will fully indemnify TI and its representatives against, any claims, damages, costs, losses, and liabilities arising out of your use of these resources.

TI's products are provided subject to TI's Terms of Sale ([www.ti.com/legal/termsofsale.html](http://www.ti.com/legal/termsofsale.html)) or other applicable terms available either on [ti.com](http://ti.com) or provided in conjunction with such TI products. TI's provision of these resources does not expand or otherwise alter TI's applicable warranties or warranty disclaimers for TI products.

Mailing Address: Texas Instruments, Post Office Box 655303, Dallas, Texas 75265  
Copyright © 2020, Texas Instruments Incorporated