

TPS6280x 1.8-V to 5.5-V, 0.6A / 1-A, 2.3- μ A I_Q Step Down Converter

6-Pin, 0.35-mm Pitch WCSP Package

1 Features

- Input Voltage Range from 1.8 V to 5.5 V
- 2.3- μ A Operating Quiescent Current
- Up to 4 MHz Switching Frequency
- Output Current 0.6 A / 1 A
- 1% Output Voltage Accuracy
- Selectable Power Save / Forced PWM Mode
- R2D converter for flexible V_{OUT} setting
- 16 Selectable + 1 Fixed Output Voltages
 - TPS62800 (4 MHz): 0.4 V to 0.775 V
 - TPS62801 (4 MHz): 0.8 V to 1.55 V
 - TPS62802 (4 MHz): 1.8 V to 3.3 V
 - TPS62806 (1.5 MHz): 0.4 V to 0.775 V
 - TPS62807 (1.5 MHz): 0.8 V to 1.55 V
 - TPS62808 (1.5 MHz): 1.8 V to 3.3 V
- Smart Enable Pin
- Optimized Pinout to Support 0201 Components
- DCS-Control™ Topology
- Output Discharge
- 100% Duty Cycle Operation
- Tiny 6-pin, 0.35 mm Pitch WCSP package
- Supports < 0.6 mm Solution Height
- Supports < 5 mm² Solution Size

2 Applications

- Wearable Electronics, IoT Applications
- 2xAA Battery Powered Applications
- Smart Phones

3 Description

The TPS6280x device family is a step down converter with 2.3- μ A typical quiescent current featuring highest efficiency and smallest solution size. TI's DCS-Control™ topology enables the device to operate with tiny inductors and capacitors with a switching frequency up to 4MHz. At light load conditions, it seamlessly enters Power Save Mode to reduce switching cycles and maintain high efficiency.

Connecting the VSEL/MODE pin to GND selects a fixed output voltage. With only one external resistor connected to VSEL/MODE pin, 16 internally set output voltages can be selected. An integrated R2D (resistor to digital) converter reads out the external resistor and sets the output voltage. The same device part number can be used for different applications and voltage rails just by changing a single resistor. Furthermore, the internally set output voltage provides better accuracy compared to a traditional external resistor divider network. Once the device has started up, the DC/DC converter enters Forced PWM Mode by applying a high level at the VSEL/MODE pin. In this operating mode, the device runs at a typical 4-MHz or 1.5-MHz switching frequency, enabling lowest output voltage ripple and highest efficiency. The TPS6280x device series comes in a tiny 6-pin WCSP package with 0.35-mm pitch.

Device Information⁽¹⁾

| PART NUMBER | PACKAGE | BODY SIZE (NOM) |
|-------------|-----------|---------------------------|
| TPS6280x | DSBGA (6) | 1.05 mm x 0.70 mm x 0.4mm |

(1) For all available packages, see the orderable addendum at the end of the datasheet.

Typical Application

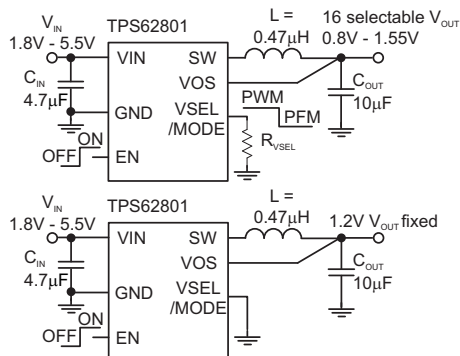

Efficiency vs. I_{OUT} at 1.2V $_{OUT}$

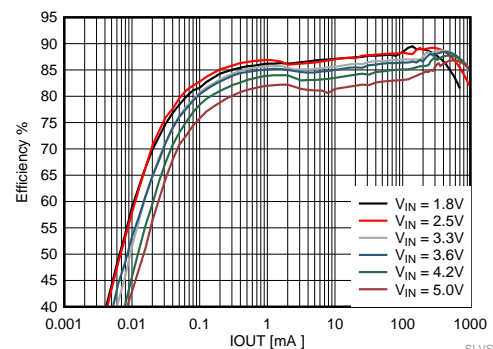

Table of Contents

| | | | | | |
|----------|--|-----------|-----------|---|-----------|
| 1 | Features | 1 | 9 | Application and Implementation | 14 |
| 2 | Applications | 1 | 9.1 | Application Information..... | 14 |
| 3 | Description | 1 | 9.2 | Typical Application | 14 |
| 4 | Revision History | 2 | 9.3 | System Examples | 25 |
| 5 | Device Comparison Table | 3 | 10 | Power Supply Recommendations | 27 |
| 6 | Pin Configuration and Functions | 3 | 11 | Layout | 27 |
| 7 | Specifications | 5 | 11.1 | Layout Guidelines | 27 |
| 7.1 | Absolute Maximum Ratings | 5 | 11.2 | Layout Example | 27 |
| 7.2 | ESD Ratings..... | 5 | 12 | Device and Documentation Support | 28 |
| 7.3 | Recommended Operating Conditions..... | 5 | 12.1 | Device Support..... | 28 |
| 7.4 | Thermal Information | 6 | 12.2 | Custom Design With WEBENCH® Tools | 28 |
| 7.5 | Electrical Characteristics..... | 6 | 12.3 | Related Links | 28 |
| 7.6 | Typical Characteristics | 8 | 12.4 | Community Resources..... | 28 |
| 8 | Detailed Description | 10 | 12.5 | Trademarks | 29 |
| 8.1 | Overview | 10 | 12.6 | Electrostatic Discharge Caution..... | 29 |
| 8.2 | Functional Block Diagram | 10 | 12.7 | Glossary | 29 |
| 8.3 | Feature Description..... | 10 | 13 | Mechanical, Packaging, and Orderable Information | 29 |
| 8.4 | Device Functional Modes..... | 13 | | | |

4 Revision History

NOTE: Page numbers for previous revisions may differ from page numbers in the current version.

| Changes from Revision D (July 2018) to Revision E | Page |
|--|------|
| • Added devices TPS62807 and TPS62808 throughout data sheet..... | 1 |

| Changes from Revision C (June 2018) to Revision D | Page |
|---|------|
| • Added device <i>TPS62800</i> to the data sheet | 1 |
| • Changed the I_{LIMF} High side and Low side values in the <i>Electrical Characteristics</i> table | 6 |

| Changes from Revision B (May 2018) to Revision C | Page |
|--|------|
| • Changed TPS62802 From: <i>Advanced Information</i> To: <i>Production</i> data..... | 1 |
| • Changed the YKA pinout image appearance | 3 |
| • Added the Optimized Transient Performance from PWM to PFM Mode Operation section | 13 |
| • Added Figure 52 to Figure 56 | 22 |
| • Changed Figure 63 | 27 |

| Changes from Revision A (March 2018) to Revision B | Page |
|--|------|
| • Added TPS62802 application curves. | 17 |

| Changes from Original (December 2017) to Revision A | Page |
|---|------|
| • Production Data release | 1 |

5 Device Comparison Table

| Device | Function VSEL/MODE | Fixed VOUT | Selectable Output Voltages with R_{VSEL} | f_{sw} [MHz] | I_{OUT} [A] | Soft Start t_{SS} | Output Discharge |
|----------|-----------------------|---------------------------|---|-------------------|------------------|------------------------|---------------------|
| TPS62800 | VSEL + MODE | 0.7V (VSEL / MODE = GND) | 0.4V - 0.775V in 25mV steps | 4 | 1 | 125 μ s | Yes |
| TPS62801 | VSEL + MODE | 1.20V (VSEL / MODE = GND) | 0.8V - 1.55V in 50mV steps | 4 | 1 | 125 μ s | Yes |
| TPS62802 | VSEL + MODE | 1.8V (VSEL / MODE = GND) | 1.8V - 3.3V in 100mV steps | 4 | 1 | 400 μ s | Yes |
| TPS62806 | VSEL + MODE | 0.7V (VSEL / MODE = GND) | 0.4V - 0.775V in 25mV steps | 1.5 | 0.6 | 125 μ s | Yes |
| TPS62807 | VSEL + MODE | 1.20V (VSEL / MODE = GND) | 0.8V - 1.55V in 50mV steps | 1.5 | 0.6 | 125 μ s | Yes |
| TPS62808 | VSEL + MODE | 1.8V (VSEL / MODE = GND) | 1.8V - 3.3V in 100mV steps | 1.5 | 0.6 | 125 μ s | Yes |

6 Pin Configuration and Functions

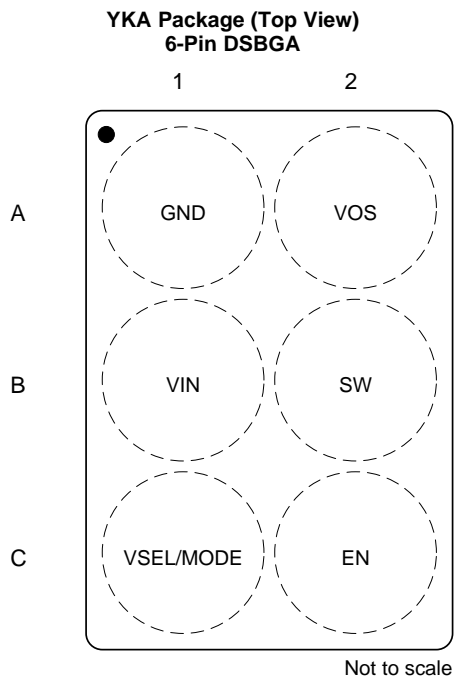

Pin Functions

| PIN | | I/O | DESCRIPTION |
|-----------|-----|-----|---|
| NAME | NO. | | |
| GND | A1 | PWR | GND supply pin. Connect this pin close to the GND terminal of the input and output capacitor. |
| VIN | B1 | PWR | V _{IN} power supply pin. Connect the input capacitor close to this pin for best noise and voltage spike suppression. A ceramic capacitor is required. |
| VSEL/MODE | C1 | IN | Connecting a resistor to GND selects a pre-defined output voltage. Once the device has started up, the R2D converter is disabled and the pin operates as an input. Applying a high level selects forced PWM mode operation and a low level power save mode operation. |
| VOS | A2 | IN | Output voltage sense pin for the internal feedback divider network and regulation loop. This pin also discharges V _{OUT} by an internal MOSFET, when the converter is disabled. Connect this pin directly to the output capacitor with a short trace. |
| SW | B2 | OUT | The switch pin is connected to the internal MOSFET switches. Connect the inductor to this terminal. |
| EN | C2 | IN | A high level enables the devices, and a low level turns the device off. The pin features an internal pulldown resistor, which is disabled once the device has started up. |

Table 1. Output Voltage Setting (VSEL/MODE Pin)

| VSEL | Output voltage setting V _{OUT} [V] | | | R _{VSEL} Resistance [kΩ], E96 Resistor Series, 1% Accuracy, Temperature Coefficient better or equal than ±200 ppm/°C |
|------|---|----------------------|----------------------|---|
| | TPS62800 TPS62806 | TPS62801 TPS62807 | TPS62802 TPS62808 | |
| 0 | 0.700 | 1.2 | 1.8 | Connected to GND (no resistor needed) |
| 1 | 0.400 | 0.8 | 1.8 | 10.0 |
| 2 | 0.425 | 0.85 | 1.9 | 12.1 |
| 3 | 0.450 | 0.9 | 2.0 | 15.4 |
| 4 | 0.475 | 0.95 | 2.1 | 18.7 |
| 5 | 0.500 | 1.0 | 2.2 | 23.7 |
| 6 | 0.525 | 1.05 | 2.3 | 28.7 |
| 7 | 0.550 | 1.1 | 2.4 | 36.5 |
| 8 | 0.575 | 1.15 | 2.5 | 44.2 |
| 9 | 0.600 | 1.2 | 2.6 | 56.2 |
| 10 | 0.625 | 1.25 | 2.7 | 68.1 |
| 11 | 0.650 | 1.3 | 2.8 | 86.6 |
| 12 | 0.675 | 1.35 | 2.9 | 105.0 |
| 13 | 0.700 | 1.4 | 3.0 | 133.0 |
| 14 | 0.725 | 1.45 | 3.1 | 162.0 |
| 15 | 0.750 | 1.5 | 3.2 | 205.0 |
| 16 | 0.775 | 1.55 | 3.3 | 249.0 or larger |

7 Specifications

7.1 Absolute Maximum Ratings⁽¹⁾

| | | MIN | MAX | UNIT |
|--|--|------|-----------------------|------|
| Pin voltage ⁽²⁾ | V _{IN} | -0.3 | 6 | V |
| | SW | -0.3 | V _{IN} +0.3V | V |
| | SW (AC), less than 10ns, while switching | -2.5 | 9 | V |
| | EN, VSEL/MODE | -0.3 | 6 | V |
| | VOS | -0.3 | 5 | V |
| Operating junction temperature, T _J | | -40 | 150 | °C |
| Storage temperature, T _{stg} | | -65 | 150 | °C |

- (1) Stresses beyond those listed under *absolute maximum ratings* may cause permanent damage to the device. These are stress ratings only and functional operation of the device at these or any other conditions beyond those indicated under *recommended operating conditions* is not implied. Exposure to absolute–maximum–rated conditions for extended periods may affect device reliability.
- (2) All voltage values are with respect to network ground terminal GND.

7.2 ESD Ratings

| | | | VALUE | UNIT |
|--------------------|-------------------------|--|-------|------|
| V _(ESD) | Electrostatic discharge | Human body model (HBM), per ANSI/ESDA/JEDEC JS-001, all pins ⁽¹⁾ | ±2000 | V |
| | | Charged device model (CDM), per JEDEC specification JESD22-C101, all pins ⁽²⁾ | ±500 | |

- (1) JEDEC document JEP155 states that 500-V HBM allows safe manufacturing with a standard ESD control process. The human body model is a 100-pF capacitor discharged through a 1.5-kΩ resistor into each pin.
- (2) JEDEC document JEP157 states that 250-V CDM allows safe manufacturing with a standard ESD control process.

7.3 Recommended Operating Conditions

| | | MIN | NOM | MAX | UNIT |
|------------------------|--|------|------|------|--------|
| V _{IN} | Supply voltage V _{IN} | 1.8 | | 5.5 | V |
| I _{OUT} | Output current V _{IN} ≥ 2.3V, TPS62800, TPS62801, TPS62802 | | | 1 | A |
| I _{OUT} | Output current V _{IN} < 2.3V, TPS62800, TPS62801, TPS62802 | | | 0.7 | A |
| I _{OUT} | Output current TPS62806, TPS62807, TPS62808 | | | 0.6 | A |
| L | Effective inductance TPS62800, TPS62801, TPS62802 | 0.33 | 0.47 | 0.82 | μH |
| C _{OUT} | Effective output capacitance, TPS62800, TPS62801, TPS62802 | | | 26 | μF |
| L | Effective inductance TPS62806, TPS62807, TPS62808 | 0.7 | 1.0 | 1.2 | μH |
| C _{OUT} | Effective output capacitance TPS62806, TPS62807, TPS62808 | | | 26 | μF |
| C _{IN} | Effective input capacitance | 0.5 | 4.7 | | μF |
| C _{VSEL/MODE} | External parasitic capacitance at VSEL/MODE pin | | | 30 | pF |
| R _{VSEL} | Resistance range for external resistor at VSEL/MODE pin (E96 1% resistor values) | 10 | | 249 | kΩ |
| | External resistor tolerance E96 series at VSEL/MODE pin | | | 1% | |
| | E96 resistor series temperature coefficient (TCR) | -200 | | +200 | ppm/°C |
| T _J | Operating junction temperature range | -40 | | 125 | °C |

7.4 Thermal Information

| THERMAL METRIC ⁽¹⁾ | | YKA (DSBGA) 6 PINS | UNIT |
|-------------------------------|--|--------------------|------|
| R _{θJA} | Junction-to-ambient thermal resistance | 147.7 | °C/W |
| R _{θJC(top)} | Junction-to-case (top) thermal resistance | 1.7 | °C/W |
| R _{θJB} | Junction-to-board thermal resistance | 47.5 | °C/W |
| ψ _{JT} | Junction-to-top characterization parameter | 0.5 | °C/W |
| ψ _{JB} | Junction-to-board characterization parameter | 47.6 | °C/W |
| R _{θJC(bot)} | Junction-to-case (bottom) thermal resistance | – | °C/W |

(1) For more information about traditional and new thermal metrics, see the [Semiconductor and IC Package Thermal Metrics](#) application report.

7.5 Electrical Characteristics

V_{IN} = 3.6 V, T_J = –40°C to 125°C typical values are at T_J = 25°C (unless otherwise noted)

| PARAMETER | | TEST CONDITIONS | MIN | TYP | MAX | UNIT |
|---------------------------------|---|---|------|------|------|------|
| SUPPLY | | | | | | |
| I _Q | Operating quiescent current (Power Save Mode) | EN = V _{IN} , I _{OUT} = 0μA, V _{OUT} = 1.2 V device not switching, T _J = –40°C to +85°C | | 2.3 | 4 | μA |
| | | EN = V _{IN} , I _{OUT} = 0μA, V _{OUT} = 1.2 V, device switching | | 2.5 | | μA |
| | Operating quiescent current (PWM Mode) | EN = V _{IN} , VSEL/MODE = V _{IN} (after power up) device switching, I _{OUT} = 0mA, V _{OUT} = 1.2V | | 8 | | mA |
| I _{SD} | Shutdown current | EN = GND, shutdown current into V _{IN} VSEL/MODE = GND, T _J = –40°C to +85°C | | 120 | 250 | nA |
| V _{TH_UVLO+} | Undervoltage lockout threshold | Rising V _{IN} | | 1.65 | 1.8 | V |
| V _{TH_UVLO–} | | Falling V _{IN} | | 1.56 | 1.7 | V |
| INPUT EN | | | | | | |
| V _{IH TH} | High level input voltage | | 0.8 | | | V |
| V _{IL TH} | Low level input voltage | | | | 0.4 | V |
| I _{IN} | Input bias current | T _J = –40°C to +85°C, EN = high | | 10 | 25 | nA |
| R _{PD} | Internal pulldown resistance | EN = low | | 500 | | kΩ |
| INPUT VSEL/MODE | | | | | | |
| V _{IH TH} | High level input voltage (digital input) | | 0.8 | | | V |
| V _{IL TH} | Low level input voltage (digital input) | | | | 0.4 | V |
| I _{IN} | Input bias current | EN = high | | 10 | 25 | nA |
| POWER SWITCHES | | | | | | |
| I _{LKG_SW} | Leakage current into SW pin | V _{SW} = 1.2V, T _J = –40°C to +85°C | | 10 | 25 | nA |
| R _{DS(ON)} | High side MOSFET on-resistance | I _{OUT} = 500 mA | | 120 | 170 | mΩ |
| | Low side MOSFET on-resistance | I _{OUT} = 500 mA | | 80 | 115 | mΩ |
| I _{LIMF} | High side MOSFET switch current limit | TPS62806, TPS62807, TPS62808 | 0.95 | 1.1 | 1.2 | A |
| I _{LIMF} | Low side MOSFET switch current limit | TPS62806, TPS62807, TPS62808 | 0.85 | 1 | 1.1 | A |
| I _{LIMF} | High side MOSFET switch current limit | TPS62800, TPS62801 | 1.3 | 1.45 | 1.55 | A |
| | | TPS62802 | 1.4 | 1.55 | 1.65 | A |
| I _{LIMF} | Low side MOSFET switch current limit | TPS62800, TPS62801 | 1.2 | 1.35 | 1.45 | A |
| | | TPS62802 | 1.3 | 1.45 | 1.55 | A |
| OUTPUT VOLTAGE DISCHARGE | | | | | | |
| R _{DSCH_VOS} | MOSFET on-resistance | EN = GND, I _{VOS} = –10 mA into VOS pin T _J = –40°C to +85°C | | 7 | 11 | Ω |
| I _{IN_VOS} | Bias current into VOS pin | EN = V _{IN} , V _{OUT} = 1.2 V (internal 12MΩ resistor divider), T _J = –40°C to +85°C | | 100 | 400 | nA |

Electrical Characteristics (continued)
 $V_{IN} = 3.6\text{ V}$, $T_J = -40^\circ\text{C}$ to 125°C typical values are at $T_J = 25^\circ\text{C}$ (unless otherwise noted)

| PARAMETER | | TEST CONDITIONS | MIN | TYP | MAX | UNIT |
|---------------------------|-------------------------------|--|-----|-----|-------|------------------|
| THERMAL PROTECTION | | | | | | |
| T_{SD} | Thermal shutdown temperature | Rising Junction Temperature, PWM mode | | 160 | | $^\circ\text{C}$ |
| | Thermal shutdown hysteresis | | | 20 | | $^\circ\text{C}$ |
| OUTPUT | | | | | | |
| V_{OUT} | Output voltage range | TPS62800, TPS62806, 25mV steps | 0.4 | | 0.775 | V |
| V_{OUT} | Output voltage range | TPS62801, TPS62807, 50mV steps | 0.8 | | 1.55 | V |
| V_{OUT} | Output voltage range | TPS62802, TPS62808, 100mV steps | 1.8 | | 3.3 | V |
| V_{OUT} | Output voltage accuracy | Power Save Mode | | 0% | | |
| V_{OUT} | Output voltage accuracy | PWM Mode $I_{OUT} = 0\text{ mA}$, $T_J = 25^\circ\text{C}$ to $+85^\circ\text{C}$ | -1% | 0% | 1% | |
| V_{OUT} | Output voltage accuracy | PWM Mode $I_{OUT} = 0\text{ mA}$, $T_J = -40^\circ\text{C}$ to $+125^\circ\text{C}$ | -2% | 0% | 1.7% | |
| f_{SW} | Switching frequency | $V_{IN} = 3.6\text{V}$, $V_{OUT} = 1.2\text{V}$, PWM operation | | 4 | | MHz |
| f_{SW} | Switching frequency | TPS62806 $V_{IN} = 3.6\text{V}$, $V_{OUT} = 0.7\text{V}$, PWM operation | | 1.5 | | MHz |
| f_{SW} | Switching frequency | TPS62807 $V_{IN} = 3.6\text{V}$, $V_{OUT} = 1.2\text{V}$, PWM operation | | 1.5 | | MHz |
| f_{SW} | Switching frequency | TPS62808 $V_{IN} = 3.6\text{V}$, $V_{OUT} = 1.8\text{V}$, PWM operation | | 1.5 | | MHz |
| $t_{Startup_delay}$ | Regulator start up delay time | From transition EN = low to high until device starts switching, VSEL = 16 | | 500 | 1100 | μs |
| t_{SS} | Soft start time | TPS62801, from $V_{OUT} = 0\text{V}$ to 0.95% of V_{OUT} nominal | | 125 | 170 | μs |
| t_{SS} | Soft start time | TPS62800, TPS62806, TPS62807, TPS62808 from $V_{OUT} = 0\text{V}$ to 0.95% of V_{OUT} nominal | | 125 | 210 | μs |
| t_{SS} | Soft start time | TPS62802, from $V_{OUT} = 0\text{V}$ to 0.95% of V_{OUT} nominal | | 400 | 500 | μs |

7.6 Typical Characteristics

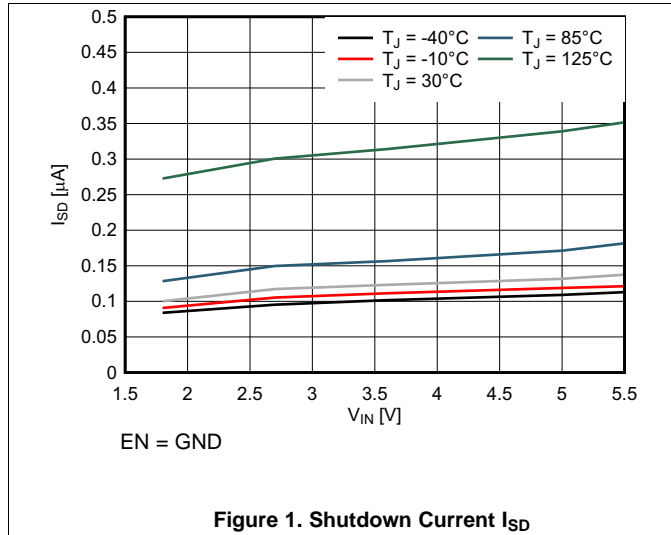

Figure 1. Shutdown Current I_{SD}

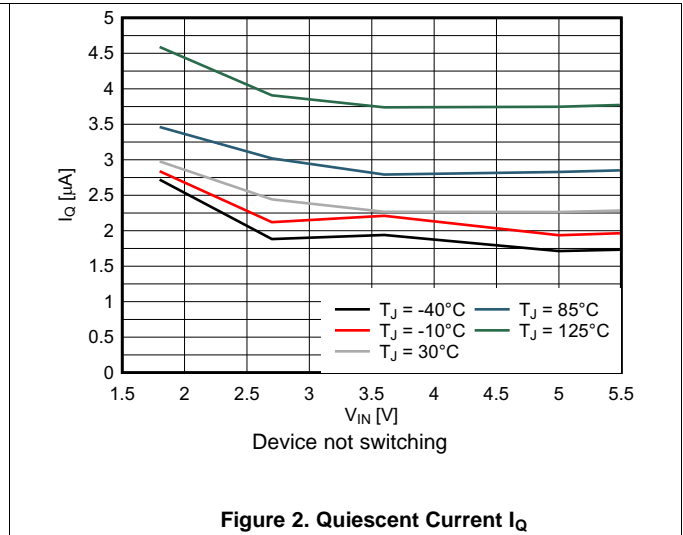

Figure 2. Quiescent Current I_Q

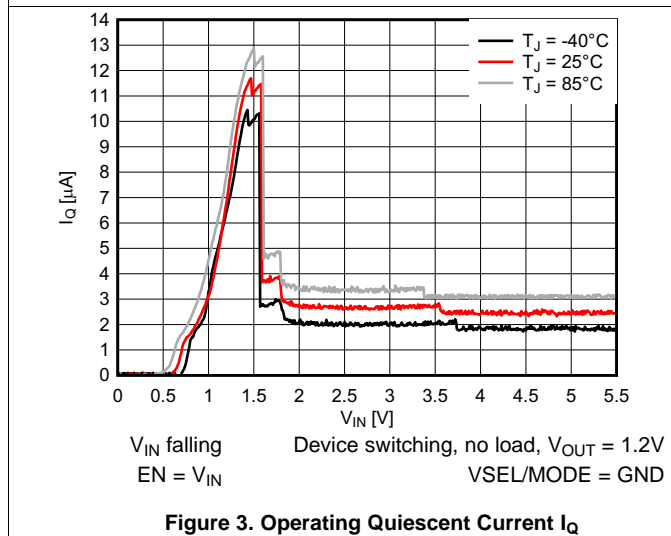

Figure 3. Operating Quiescent Current I_Q

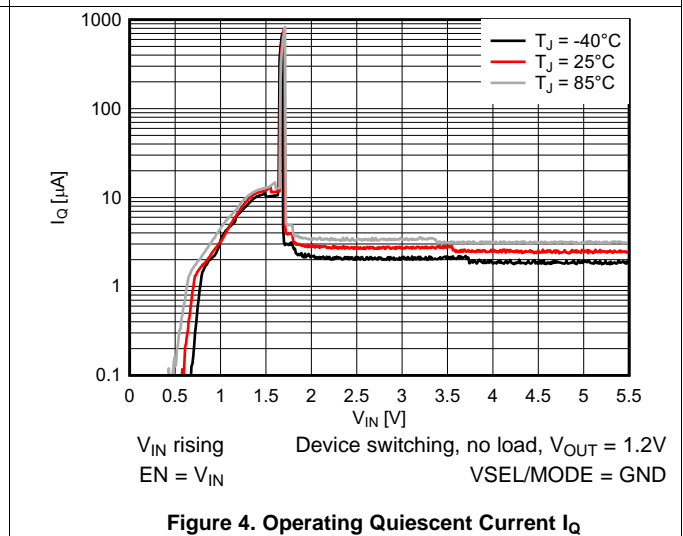

Figure 4. Operating Quiescent Current I_Q

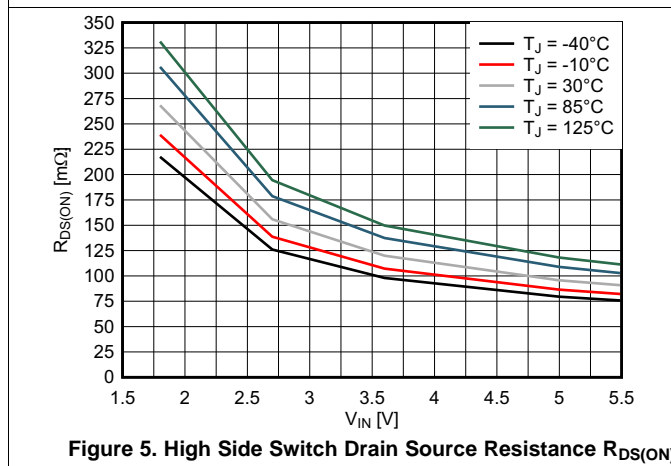

Figure 5. High Side Switch Drain Source Resistance $R_{DS(ON)}$

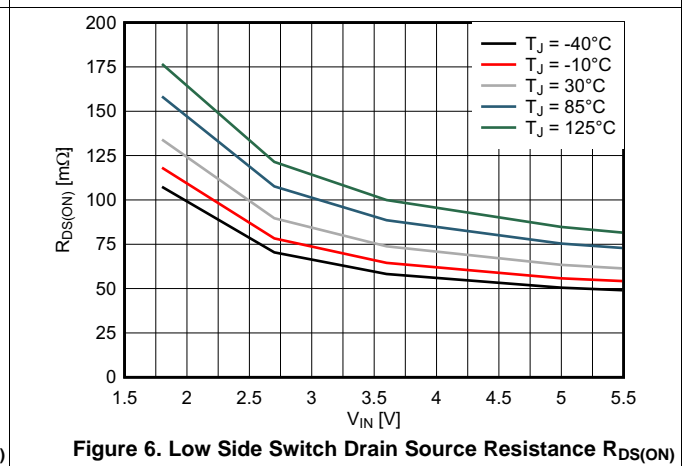

Figure 6. Low Side Switch Drain Source Resistance $R_{DS(ON)}$

Typical Characteristics (continued)

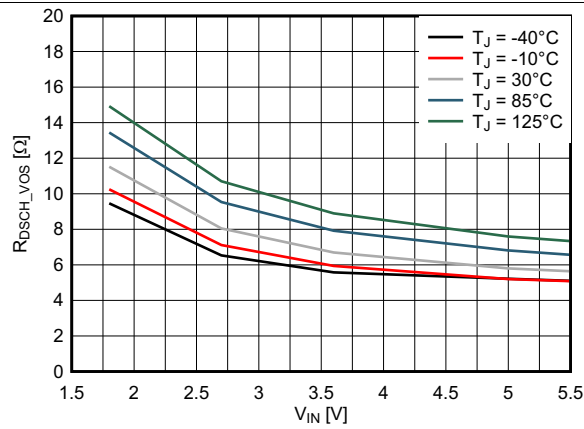

Figure 7. VOS Discharge Switch Drain Source Resistance R_{DSCH_VOS}

8 Detailed Description

8.1 Overview

The TPS6280x is a high frequency synchronous step down converter with ultra low quiescent current consumption. Using TI's DCS-Control™ topology, the device extends the high efficiency operation area down to microamperes of load current during Power Save Mode Operation. TI's DCS-Control™ (Direct Control with Seamless Transition into Power Save Mode) is an advanced regulation topology, which combines the advantages of hysteretic and voltage mode control. Characteristics of DCS-Control™ are excellent AC load regulation and transient response, low output ripple voltage and a seamless transition between PFM and PWM mode operation. DCS-Control™ includes an AC loop which senses the output voltage (VOS pin) and directly feeds the information to a fast comparator stage. This comparator sets the switching frequency, which is constant for steady state operating conditions, and provides immediate response to dynamic load changes. In order to achieve accurate DC load regulation, a voltage feedback loop is used. The internally compensated regulation network achieves fast and stable operation with small external components and low ESR capacitors.

8.2 Functional Block Diagram

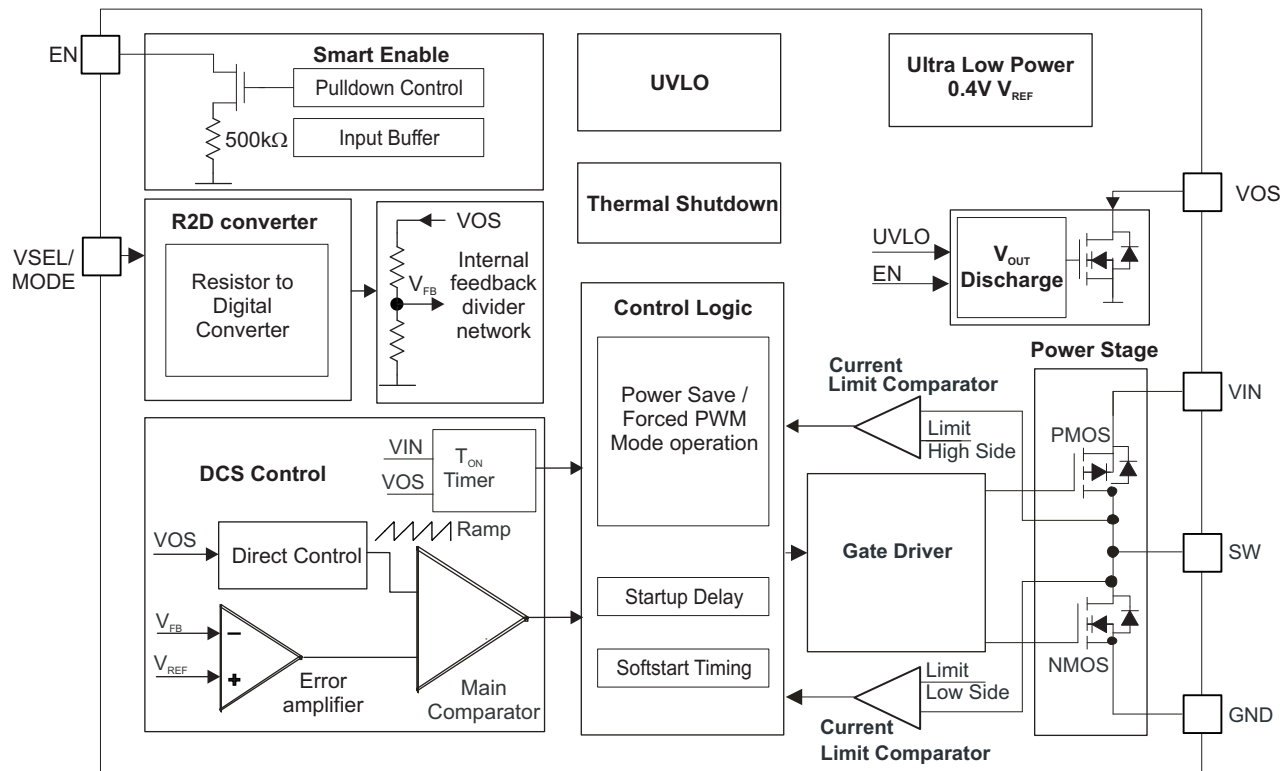

Figure 8. Functional Block Diagram

8.3 Feature Description

8.3.1 Smart Enable and Shutdown (EN)

An internal 500kΩ resistor pulls the EN pin to GND and avoids the pin to be floating. This prevents an uncontrolled startup of the device in case the EN pin cannot be driven to low level safely. With EN low, the device is in shutdown mode. The device is turned on with EN set to a high level. The pull-down control circuit disconnects the pull-down resistor on the EN pin once the internal control logic and the reference have been powered up. With EN set to a low level, the device enters shutdown mode and the pull-down resistor is activated again.

Feature Description (continued)

8.3.2 Softstart

Once the device has been enabled with EN high, it initializes and powers up its internal circuits. This occurs during the regulator startup delay time $t_{\text{Startup_delay}}$. Once $t_{\text{Startup_delay}}$ expires, the internal soft start circuitry ramps up the output voltage within the Soft start time t_{SS} , see [Figure 9](#).

The startup delay time $t_{\text{Startup_delay}}$ varies depending on the selected VSEL value. It is shortest with VSEL = 0 and longest with VSEL = 16. See [Figure 52](#) to [Figure 56](#).

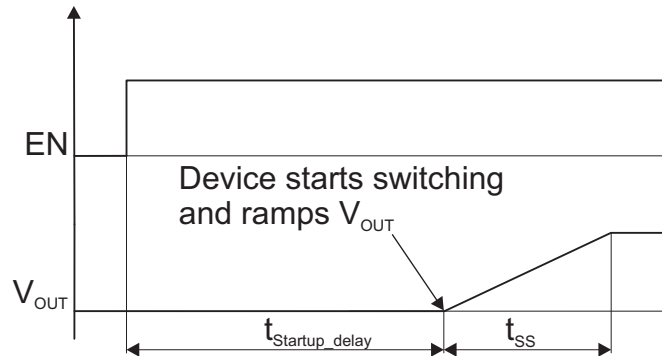

Figure 9. Device Startup

8.3.3 VSEL/MODE Pin

This pin has two functions, output voltage selection during startup of the converter and operating mode selection. See also [Device Comparison Table](#).

8.3.3.1 Output Voltage Selection (R2D Converter)

The output voltage is set with a single external resistor connected between the VSEL/MODE pin and GND. Once the device has been enabled and the control logic as well as the internal reference have been powered up, a R2D (resistor to digital) conversion is started to detect the external resistor R_{VSEL} within the regulator startup delay time $t_{\text{Startup_delay}}$. An internal current source applies current through the external resistor and an internal ADC reads back the resulting voltage level. Depending on the level, an internal feedback divider network is selected to set the correct output voltage. Once this R2D conversion is finished, the current source is turned off to avoid current flow through the external resistor.

After power up, the pin is configured as an input for Mode Selection. Therefore, the output voltage is set only once. If the Mode selection function is used in combination with the VSEL function, ensure that there is no additional current path or capacitance greater than 30pF total to GND, during R2D conversion. Otherwise the additional current to GND is interpreted as a lower resistor value and a false output voltage will be set. [Table 1](#) lists the correct resistor values for R_{VSEL} to set the appropriate output voltages. The R2D converter is designed to operate with resistor values out of the E96 table and requires 1% resistor value accuracy. The external resistor R_{VSEL} is not a part of the regulator feedback loop and has therefore no impact on the output voltage accuracy. Ensure that there is no other leakage path than the R_{VSEL} resistor at the VSEL/MODE pin during an undervoltage lockout event. Otherwise a false output voltage will be set.

Connecting VSEL/MODE to GND selects a pre-defined output voltage (TPS62800 = 0.7 V, TPS62801 = 1.2 V, TPS62802 = 1.8 V, TPS62806 = 0.7 V, TPS62807 = 1.2 V, TPS62808 = 1.8 V). In this case, no external resistor is needed which enables a smaller solution size.

8.3.3.2 Mode Selection: Power Save Mode / Forced PWM Operation

A low level at this pin selects Power Save Mode operation, and a high level selects forced PWM operation. The Mode can be changed during operation after the device has been powered up. The Mode selection function is only available after the R2D converter has read out the external resistor.

Feature Description (continued)

8.3.4 Undervoltage Lockout (UVLO)

To avoid misoperation of the device at low input voltages, an undervoltage lockout (UVLO) comparator monitors the supply voltage. The UVLO comparator shuts down the device at an input voltage of 1.7V (max) with falling V_{IN} . The device starts at an input voltage of 1.8V (max) rising V_{IN} . Once the device re-enters operation out of an undervoltage lockout condition, it behaves like being enabled. The internal control logic is powered up and the external resistor at the VSEL/MODE pin is read out.

8.3.5 Switch Current Limit / Short Circuit Protection

The TPS6280x integrates a current limit on the high side, as well on the low side MOSFETs to protect the device against overload or short circuit conditions. The current in the switches is monitored cycle by cycle. If the high side MOSFET current limit I_{LIMF} trips, the high side MOSFET is turned off and the low side MOSFET is turned on to ramp down the inductor current. Once the inductor current through the low side switch decreases below the low side MOSFET current limit I_{LIMF} , the low side MOSFET is turned off and the high side MOSFET turns on again.

8.3.6 Thermal Shutdown

The junction temperature (T_J) of the device is monitored by an internal temperature sensor. If T_J exceeds the thermal shutdown temperature T_{SD} of 160°C (typ), the device enters thermal shutdown. Both the high side and low side power FETs are turned off. When T_J decreases below the hysteresis amount of typically 20°C, the converter resumes operation, beginning with a soft start to the originally set V_{OUT} (there is no R2D conversion of R_{VSEL}). The thermal shutdown is not active in Power Save Mode.

8.3.7 Output Voltage Discharge

The purpose of the output discharge function is to ensure a defined down-ramp of the output voltage when the device is disabled and to keep the output voltage close to 0 V. The output discharge feature is only active once the device has been enabled at least once since the supply voltage was applied. The output discharge function is not active if the device is disabled and the supply voltage is applied the first time.

The internal discharge resistor is connected to the VOS pin. The discharge function is enabled as soon as the device is disabled. The minimum supply voltage required to keep the discharge function active is $V_{IN} > V_{TH_UVLO}$.

8.4 Device Functional Modes

8.4.1 Power Save Mode Operation

The DCS-Control™ topology supports Power Save Mode operation. At light loads the device operates in PFM (Pulse Frequency Modulation) mode that generates a single switching pulse to ramp up the inductor current and recharge the output capacitor, followed by a sleep period where most of the internal circuits are shutdown to achieve lowest operating quiescent current. During this time, the load current is supported by the output capacitor. The duration of the sleep period depends on the load current and the inductor peak current. During the sleep periods, the current consumption is reduced to typically 2.3 μA . This low quiescent current consumption is achieved by an ultra low power voltage reference, an integrated high impedance feedback divider network and an optimized Power Save Mode operation.

In PFM Mode, the switching frequency varies linearly with the load current. At medium and high load conditions, the device enters automatically PWM (Pulse Width Modulation) mode and operates in continuous conduction mode with a nominal switch frequency f_{sw} of typically 4MHz or 1.5MHz. The switching frequency in PWM mode is controlled and depends on V_{IN} and V_{OUT} . The boundary between PWM and PFM mode is when the inductor current becomes discontinuous.

If the load current decreases, the converter seamlessly enters PFM mode to maintain high efficiency down to very light loads. Since DCS-Control™ supports both operation modes within one single building block, the transition from PWM to PFM Mode is seamless with minimum output voltage ripple.

8.4.2 Forced PWM Mode Operation

After the device has powered up and ramped up V_{OUT} , the VSEL/MODE pin acts as an input. With a high level on VSEL/MODE pin, the device enters forced PWM Mode and operates with a constant switching frequency over the entire load range, even at very light loads. This reduces or eliminates interference with RF and noise sensitive circuits, but lowers efficiency at light loads.

8.4.3 100% Mode Operation

The duty cycle of the buck converter operating in PWM mode is given as $D = V_{\text{OUT}}/V_{\text{IN}}$. The duty cycle increases as the input voltage comes close to the output voltage. In 100% duty cycle mode, it keeps the high side switch on continuously. The high side switch stays turned on as long as the output voltage is below the internal set point. This allows the conversion of small input to output voltage differences.

8.4.4 Optimized Transient Performance from PWM to PFM Mode Operation

For most converters, the load transient response in PWM mode is improved compared to PFM mode, since the converter reacts faster on the load step and actively sinks energy on the load release. Compare figure [Figure 43](#) and [Figure 42](#). As an additional feature, the TPS6280x automatically enters PWM mode for 16 cycles after a heavy load release in order to bring the output voltage back to the regulation level faster. After 16 cycles of PWM mode, it automatically returns to PFM mode (if VSEL/MODE is driven low). See [Figure 10](#). Without this optimization, the output voltage overshoot would be higher and would look like the V_{OUT} ' trace. This feature is only active once the load is high enough and the converter operates in PWM mode.

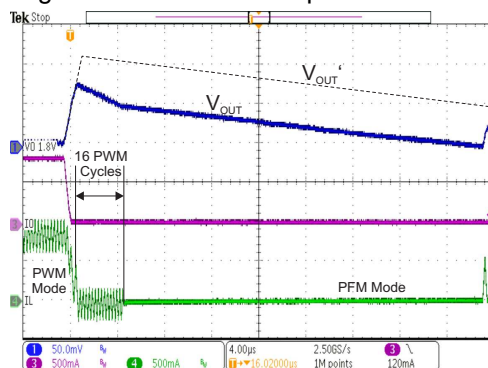

Figure 10. Optimized Transient Performance from PWM to PFM Mode

9 Application and Implementation

NOTE

Information in the following applications sections is not part of the TI component specification, and TI does not warrant its accuracy or completeness. TI's customers are responsible for determining suitability of components for their purposes. Customers should validate and test their design implementation to confirm system functionality.

9.1 Application Information

The following section discusses the design of the external components to complete the power supply design for several input and output voltage options by using typical applications as a reference.

9.2 Typical Application

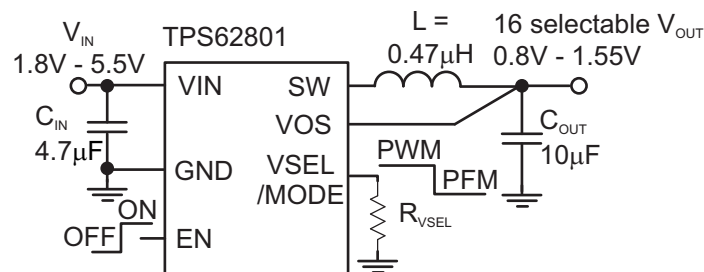

Figure 11. TPS62801 Adjustable V_{OUT} Application Circuit

Additional circuits are shown in the [System Examples](#) section.

9.2.1 Design Requirements

[Table 2](#) shows the list of components for the application circuit and the characteristic application curves

Table 2. Components for Application Characteristic Curves

| Reference | Description | Value | Size [L x W X T] | Manufacturer ⁽¹⁾ |
|--------------|---------------------------------------|--------------|-----------------------------------|-----------------------------|
| TPS62801 / 2 | Step down converter | | 1.05mm x 0.70mm x 0.4mm max. | Texas Instruments |
| C_{IN} | Ceramic capacitor, GRM155R60J475ME47D | 4.7 μ F | 0402 (1mm x 0.5mm x 0.6mm max.) | Murata |
| C_{OUT} | Ceramic capacitor, GRM155R60J106ME15D | 10 μ F | 0402 (1mm x 0.5mm x 0.65mm max.) | Murata |
| L | Inductor DFE18SANR47MG0L | 0.47 μ H | 0603 (1.6mm x 0.8mm x 1.0mm max.) | Murata |

(1) See [Third-party Products Disclaimer](#)

9.2.2 Detailed Design Procedure

9.2.2.1 Custom Design With WEBENCH® Tools

[Click here](#) to create a custom design using the TPS62800 device with the WEBENCH® Power Designer.

[Click here](#) to create a custom design using the TPS62801 device with the WEBENCH® Power Designer.

[Click here](#) to create a custom design using the TPS62802 device with the WEBENCH® Power Designer.

[Click here](#) to create a custom design using the TPS62806 device with the WEBENCH® Power Designer.

[Click here](#) to create a custom design using the TPS62807 device with the WEBENCH® Power Designer.

[Click here](#) to create a custom design using the TPS62808 device with the WEBENCH® Power Designer.

1. Start by entering the input voltage (V_{IN}), output voltage (V_{OUT}), and output current (I_{OUT}) requirements.
2. Optimize the design for key parameters such as efficiency, footprint, and cost using the optimizer dial.
3. Compare the generated design with other possible solutions from Texas Instruments.

The WEBENCH Power Designer provides a customized schematic along with a list of materials with real-time pricing and component availability.

In most cases, these actions are available:

- Run electrical simulations to see important waveforms and circuit performance
- Run thermal simulations to understand board thermal performance
- Export customized schematic and layout into popular CAD formats
- Print PDF reports for the design, and share the design with colleagues

Get more information about WEBENCH tools at www.ti.com/WEBENCH.

9.2.2.2 Inductor Selection

The inductor value affects the peak-to-peak ripple current, the PWM-to-PFM transition point, the output voltage ripple and the efficiency. The selected inductor has to be rated for its DC resistance and saturation current. The inductor ripple current (ΔI_L) decreases with higher inductance and increases with higher V_{IN} or V_{OUT} and can be estimated according to [Equation 1](#).

[Equation 2](#) calculates the maximum inductor current under static load conditions. The saturation current of the inductor should be rated higher than the maximum inductor current, as calculated with [Equation 2](#). This is recommended because during a heavy load transient the inductor current rises above the calculated value. A more conservative way is to select the inductor saturation current according to the high side MOSFET switch current limit, I_{LIMF} .

$$\Delta I_L = V_{out} \times \frac{1 - \frac{V_{out}}{V_{in}}}{L \times f} \quad (1)$$

$$I_{Lmax} = I_{outmax} + \frac{\Delta I_L}{2}$$

where

- f = Switching Frequency
 - L = Inductor Value
 - ΔI_L = Peak to Peak inductor ripple current
 - I_{Lmax} = Maximum Inductor current
- (2)

Table 3 shows a list of possible inductors.

Table 3. List of Possible Inductors⁽¹⁾

| INDUCTANCE [μ H] | INDUCTOR SERIES | SIZE IMPERIAL (METRIC) | DIMENSIONS L x W x T | SUPPLIER ⁽¹⁾ |
|-----------------------|-----------------|------------------------|-----------------------------|-------------------------|
| 0.47 | DFE18SAN_G0 | 0603 (1608) | 1.6mm x 0.8mm x 1.0mm max | Murata |
| 0.47 | HTEB16080F | 0603 (1608) | 1.6mm x 0.8mm x 0.6mm max. | Cyntec |
| 0.47 | HTET1005FE | 0402 (1005) | 1.0mm x 0.5mm x 0.65mm max. | Cyntec |
| 0.47 | TFM160808ALC | 0603 (1608) | 1.6mm x 0.8mm x 0.8mm max. | TDK |
| 1.0 | DFE201610E | 0806 (201610) | 2.0mm x 1.6mm x 1.0mm max | Murata |

(1) See [Third-party Products Disclaimer](#)

9.2.2.3 Output Capacitor Selection

The DCS-Control™ scheme of the TPS6280x allows the use of tiny ceramic capacitors. Ceramic capacitors with low ESR values have the lowest output voltage ripple and are recommended. The output capacitor requires either an X7R or X5R dielectric. At light load currents, the converter operates in Power Save Mode and the output voltage ripple is dependent on the output capacitor value. A larger output capacitors can be used reducing the output voltage ripple.

The inductor and output capacitor together provide a low-pass filter. To simplify this process, [Table 4](#) outlines possible inductor and capacitor value combinations.

Table 4. Recommended LC Output Filter Combinations

| Device | Nominal Inductor Value [μ H] | Nominal Output Capacitor Value [μ F] | | | |
|------------------------------|-----------------------------------|---|------------------|----------------|------------|
| | | 4.7 μ F | 10 μ F | 2 x 10 μ F | 22 μ F |
| TPS62800, TPS62801 | 0.47 ⁽¹⁾ | √ | √ ⁽²⁾ | √ | √ |
| TPS62802 | 0.47 ⁽¹⁾ | | √ ⁽²⁾ | √ | √ |
| TPS62806, TPS62807, TPS62808 | 1.0 ⁽³⁾ | √ | √ ⁽²⁾ | √ | √ |

(1) An effective inductance range of 0.33 μ H to 0.82 μ H is recommended. An effective capacitance range of 2 μ F to 26 μ F is recommended.

(2) Typical application configuration. Other check marks indicate alternative filter combinations.

(3) An effective inductance range of 0.7 μ H to 1.2 μ H is recommended. An effective capacitance range of 3 μ F to 26 μ F is recommended.

9.2.2.4 Input Capacitor Selection

Because the buck converter has a pulsating input current, a low ESR ceramic input capacitor is required for best input voltage filtering to minimize input voltage spikes. For most applications a 4.7- μ F input capacitor is sufficient. When operating from a high impedance source, like a coin cell, a larger input buffer capacitor $\geq 10\mu$ F is recommended to avoid voltage drops during startup and load transients. The input capacitor can be increased without any limit for better input voltage filtering. The leakage current of the input capacitor adds to the overall current consumption.

[Table 5](#) shows a selection of input and output capacitors.

Table 5. List of Possible Capacitors⁽¹⁾

| CAPACITANCE [μ F] | CAPACITOR PART NUMBER | SIZE IMPERIAL (METRIC) | DIMENSIONS L x W x T | SUPPLIER ⁽¹⁾ |
|------------------------|-----------------------|------------------------|-----------------------------|-------------------------|
| 4.7 | GRM155R60J475ME47D | 0402 (1005) | 1.0mm x 0.5mm x 0.6mm max. | Murata |
| 4.7 | GRM035R60J475ME15 | 0201 (0603) | 0.6mm x 0.3mm x 0.55mm max | Murata |
| 10 | GRM155R60J106ME15D | 0402 (1005) | 1.0mm x 0.5mm x 0.65mm max. | Murata |

(1) See [Third-party Products Disclaimer](#)

9.2.3 Application Curves

The conditions for the below application curves are $V_{IN} = 3.6\text{ V}$, $V_{OUT} = 1.2\text{ V}$ and the components listed in Table 2, unless otherwise noted.

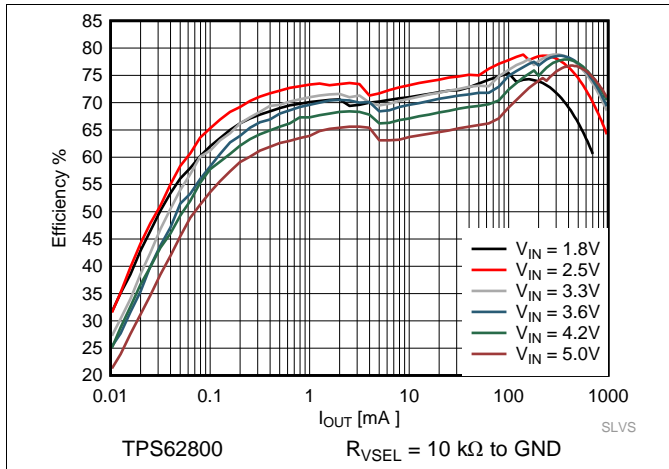

Figure 12. Efficiency Power Save Mode $V_{OUT} = 0.4\text{ V}$

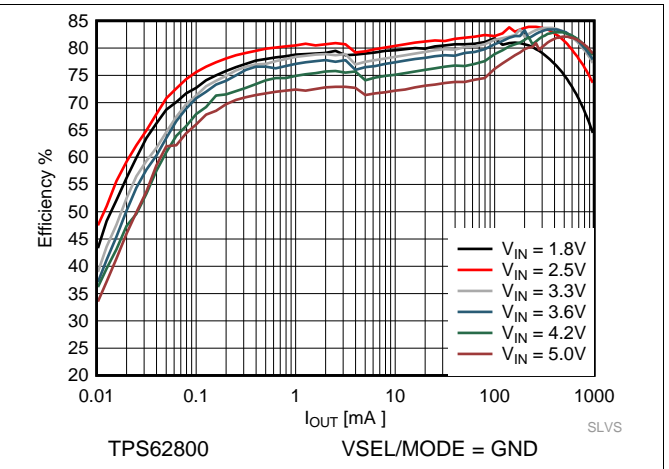

Figure 13. Efficiency Power Save Mode $V_{OUT} = 0.7\text{ V}$

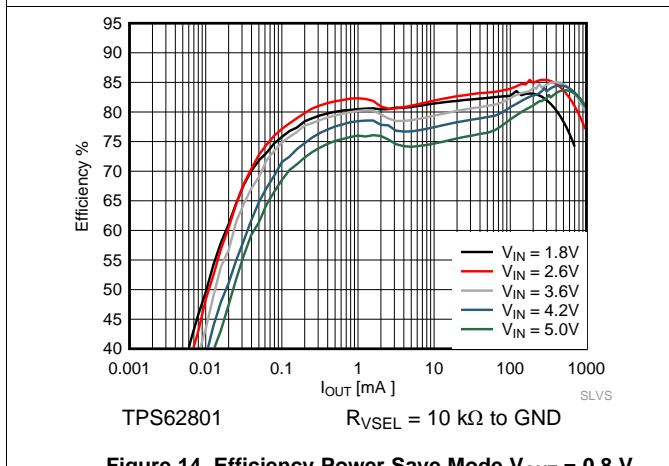

Figure 14. Efficiency Power Save Mode $V_{OUT} = 0.8\text{ V}$

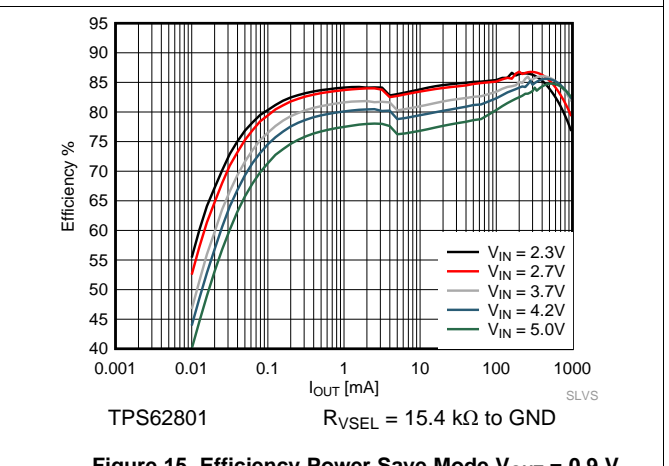

Figure 15. Efficiency Power Save Mode $V_{OUT} = 0.9\text{ V}$

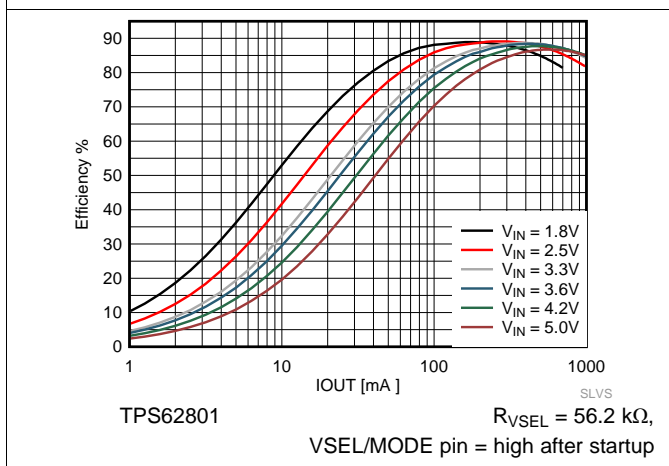

Figure 16. Efficiency Forced PWM Mode $V_{OUT} = 1.2\text{ V}$

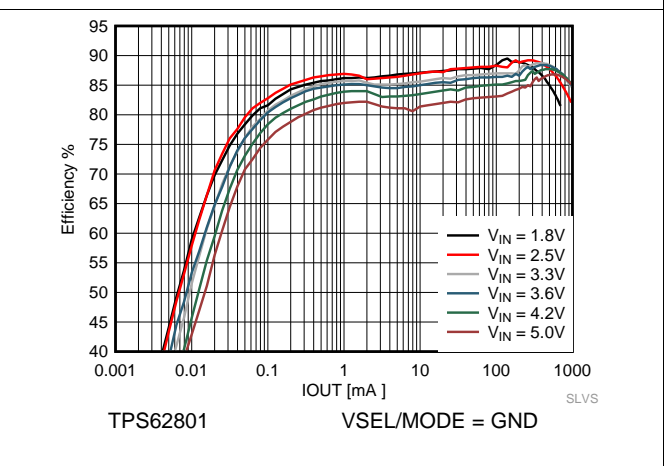

Figure 17. Efficiency Power Save Mode $V_{OUT} = 1.2\text{ V}$

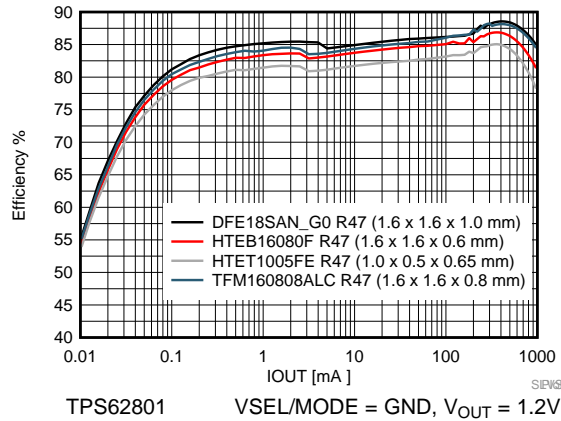

Figure 18. Inductor Comparison

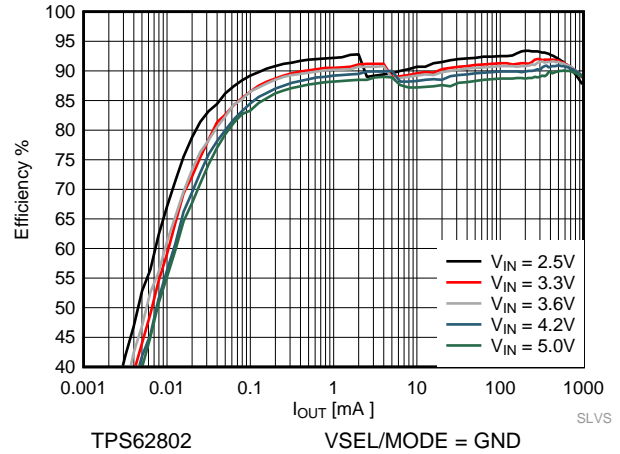

Figure 19. Efficiency Power Save Mode $V_{OUT} = 1.8\text{ V}$

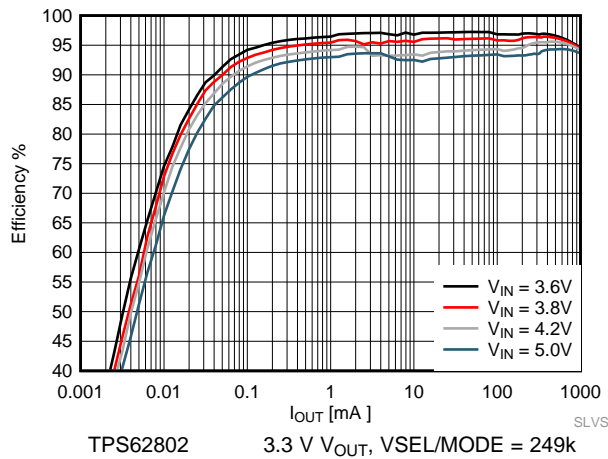

Figure 20. Efficiency Power Save Mode $V_{OUT} = 3.3\text{ V}$

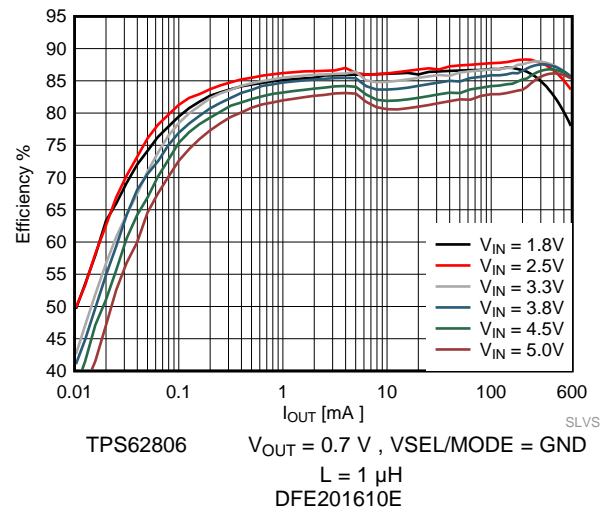

Figure 21. Efficiency Power Save Mode $V_{OUT} = 0.7\text{ V}$

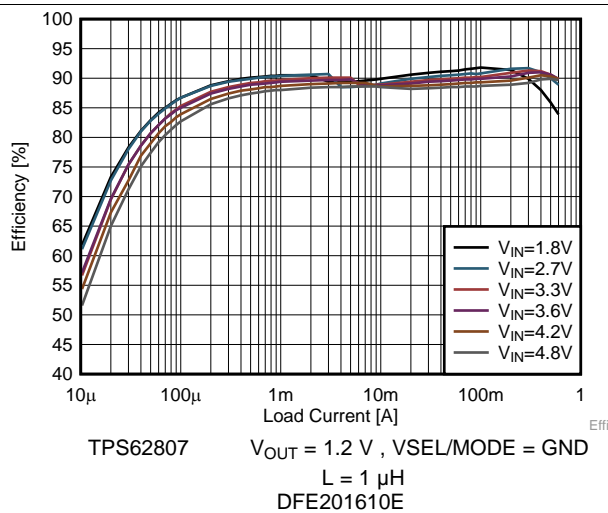

Figure 22. Efficiency Power Save Mode $V_{OUT} = 1.2\text{ V}$

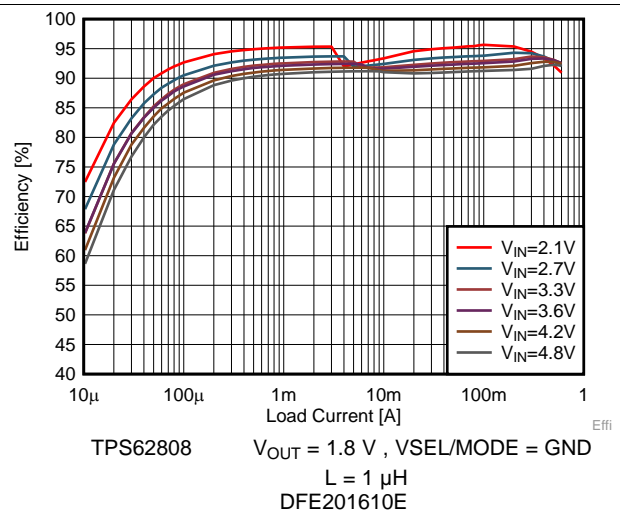

Figure 23. Efficiency Power Save Mode $V_{OUT} = 1.8\text{ V}$

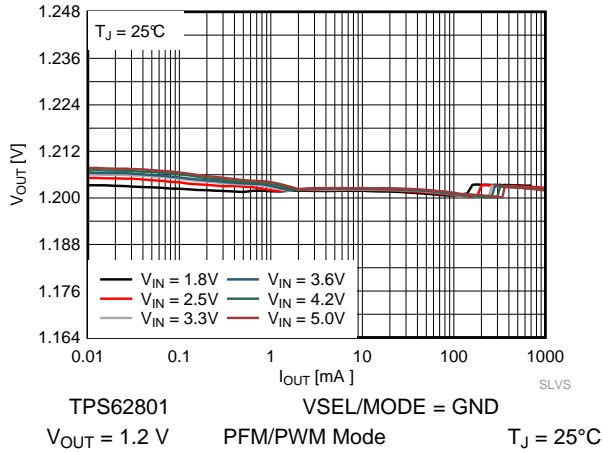

Figure 24. Output Voltage vs. Output Current

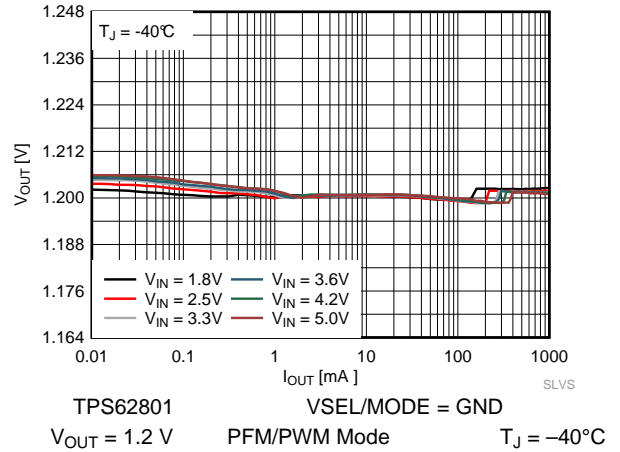

Figure 25. Output Voltage vs. Output Current

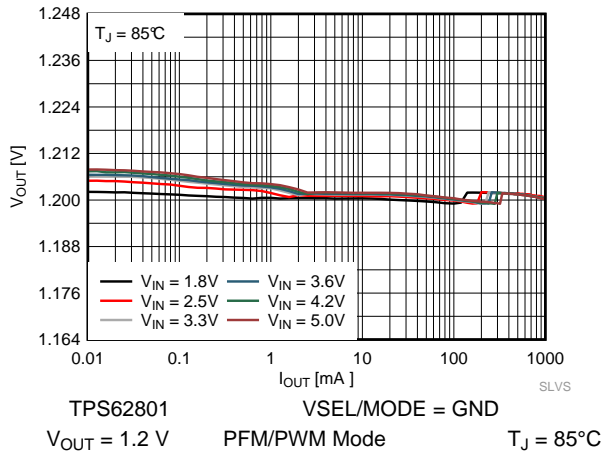

Figure 26. Output Voltage vs. Output Current

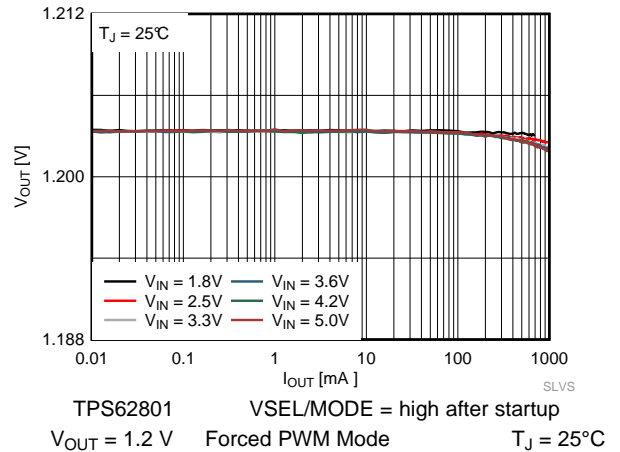

Figure 27. Output Voltage vs. Output Current

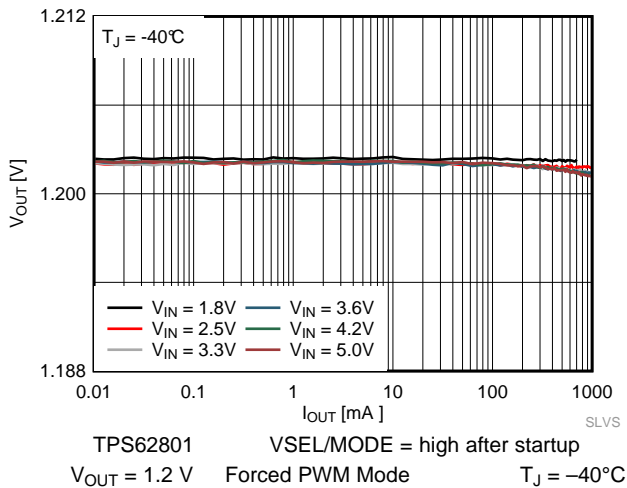

Figure 28. Output Voltage vs. Output Current

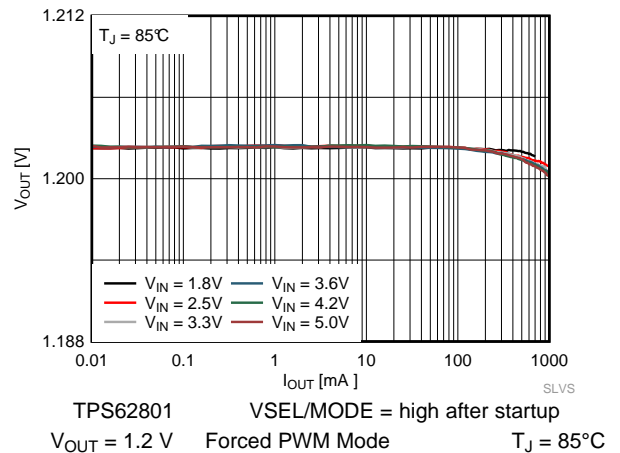

Figure 29. Output Voltage vs. Output Current

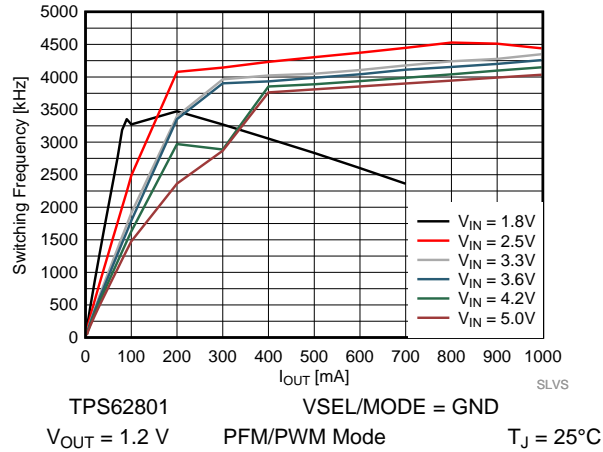

Figure 30. Switching Frequency vs. Output Current

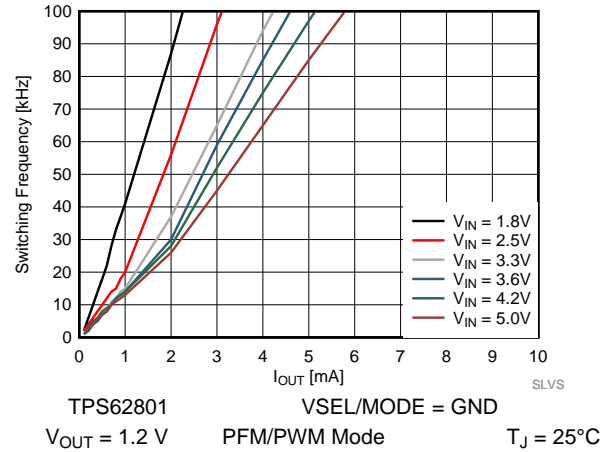

Figure 31. Switching Frequency (zoom in)

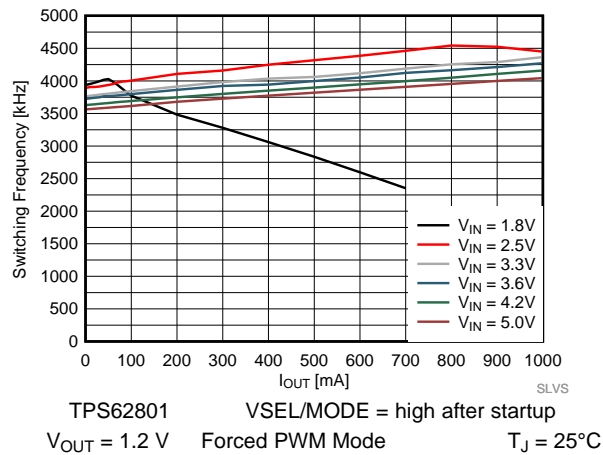

Figure 32. Switching Frequency vs. Output Current

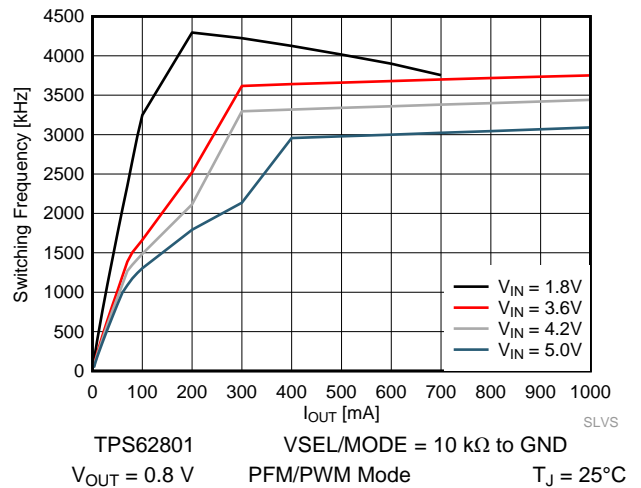

Figure 33. Switching Frequency vs. Output Current

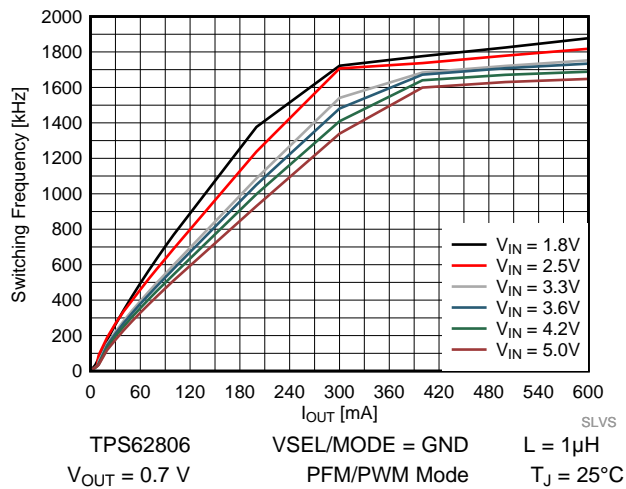

Figure 34. Switching Frequency vs. Output Current

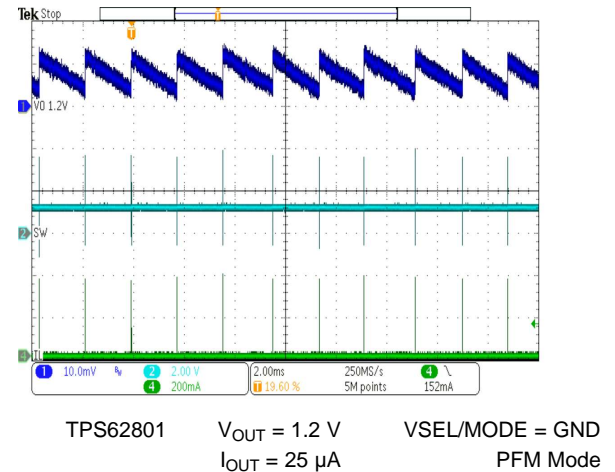
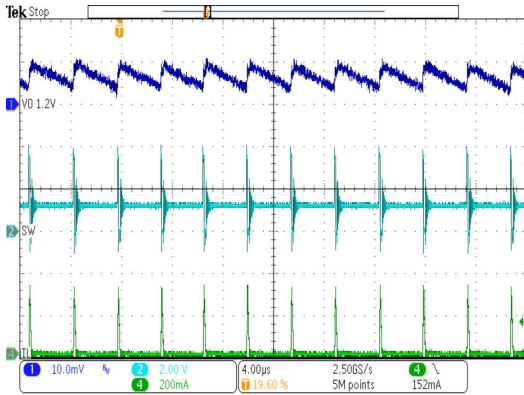
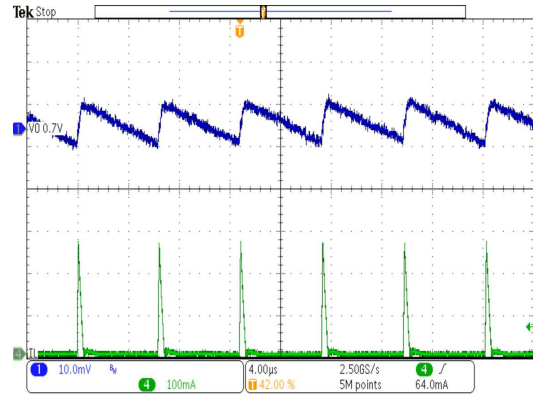

Figure 35. Typical Operation Power Save Mode



TPS62801 $V_{OUT} = 1.2\text{ V}$ $V_{SEL}/MODE = GND$
 $I_{OUT} = 10\text{ mA}$ PFM Mode

Figure 36. Typical Operation Power Save Mode



TPS62806 $V_{OUT} = 0.7\text{ V}$ $V_{SEL}/MODE = GND$
 $V_{IN} = 3.8\text{ V}$ $I_{OUT} = 10\text{ mA}$ PFM Mode, $L = 1\mu\text{H}$
 DFE201610E

Figure 37. TPS62806 Typical operation Power Save Mode

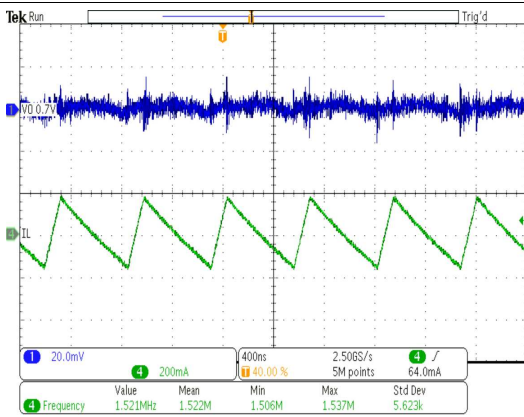

TPS62806 $V_{OUT} = 0.7\text{ V}$ $V_{SEL}/MODE = V_{IN}$
 (after startup)
 $V_{IN} = 3.8\text{ V}$ $I_{OUT} = 0\text{ mA}$ PFM Mode, $L = 1\mu\text{H}$
 DFE201610E

Figure 38. TPS62806 typical forced PWM mode operation (1.5MHz)

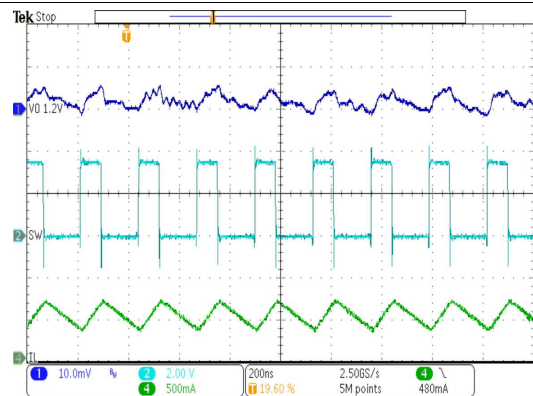

TPS62801 $V_{OUT} = 1.2\text{ V}$ $V_{SEL}/MODE = GND$
 $I_{OUT} = 500\text{ mA}$ PWM Mode

Figure 39. Typical Operation PWM Mode

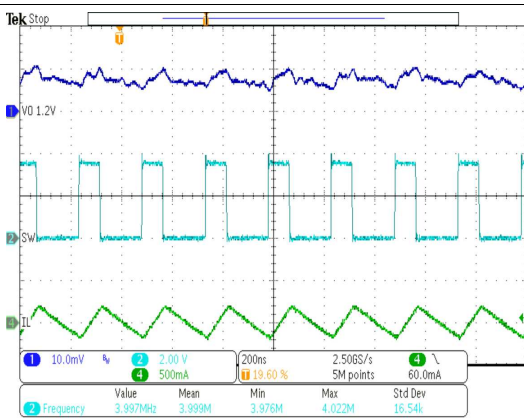

TPS62801 $V_{OUT} = 1.2\text{ V}$ $I_{OUT} = 0\text{ mA}$
 Forced PWM Mode $V_{SEL}/MODE = V_{IN}$ (after startup)

Figure 40. Typical Operation Forced PWM Mode

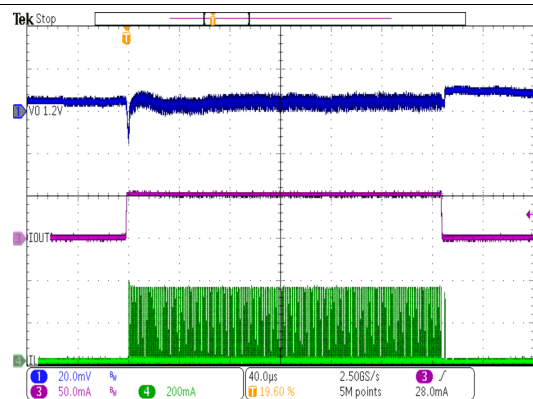

TPS62801 $V_{OUT} = 1.2\text{ V}$ $V_{SEL}/MODE = GND$
 rise / fall time < 1 μs $I_{OUT} = 0\text{ mA}$ to 50 mA, PFM Mode

Figure 41. Load Transient Power Save Mode

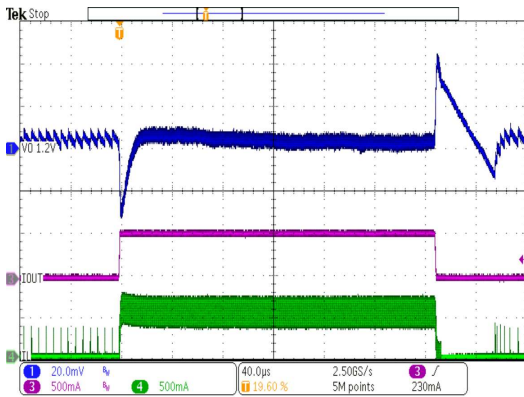

TPS62801 $V_{OUT} = 1.2\text{ V}$ $VSEL/MODE = \text{GND}$
 rise / fall time $< 1\ \mu\text{s}$ PFM / PWM Mode
 $I_{OUT} = 5\text{ mA to } 500\text{ mA}$

Figure 42. Load Transient Power Save Mode

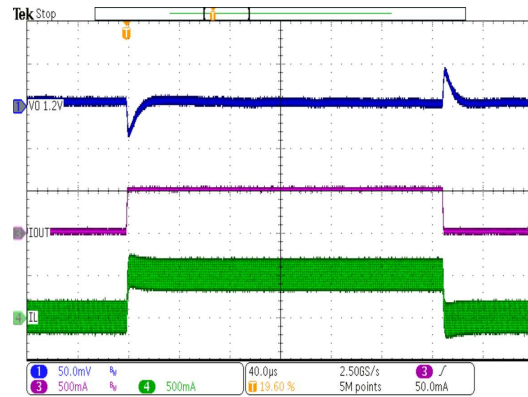

TPS62801 $V_{OUT} = 1.2\text{ V}$ $VSEL/MODE = \text{VIN}$
 rise / fall time $< 1\ \mu\text{s}$ (after startup)
 Forced PWM Mode $I_{OUT} = 5\text{ mA to } 500\text{ mA}$

Figure 43. Load Transient Forced PWM Mode

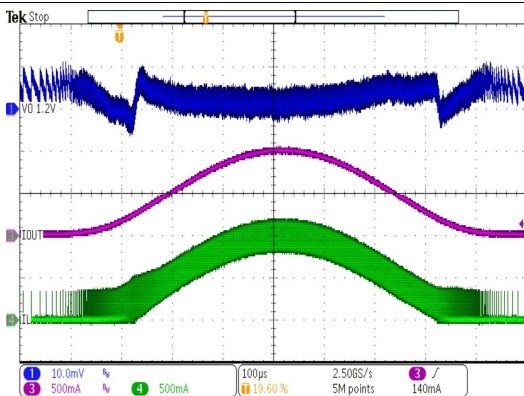

TPS62801 $V_{OUT} = 1.2\text{ V}$ $VSEL/MODE = \text{GND}$
 $I_{OUT} = 1\text{ mA to } 1\text{ A } 1\text{ kHz}$ PFM/PWM Mode

Figure 44. AC Load Sweep Power Save Mode

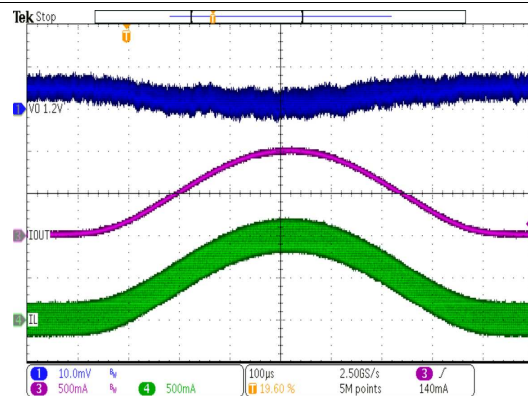

TPS62801 $V_{OUT} = 1.2\text{ V}$ $VSEL/MODE = \text{VIN}$
 $I_{OUT} = 1\text{ mA to } 1\text{ A } 1\text{ kHz}$ (after startup)
 Forced PWM Mode

Figure 45. AC Load Sweep Forced PWM Mode

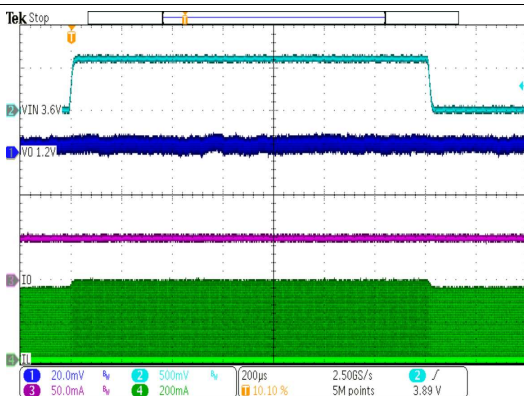

TPS62801 $V_{OUT} = 1.2\text{ V}$ $V_{IN} = 3.6\text{ V to } 4.2\text{ V}$
 rise / fall time = $10\ \mu\text{s}$ $I_{OUT} = 50\text{ mA}$

Figure 46. Line Transient PFM Mode

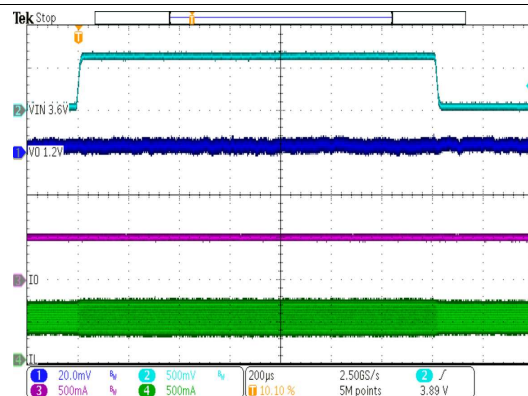

TPS62801 $V_{OUT} = 1.2\text{ V}$ $V_{IN} = 3.6\text{ V to } 4.2\text{ V}$
 rise / fall time = $10\ \mu\text{s}$ $I_{OUT} = 500\text{ mA}$

Figure 47. Line Transient PWM Mode

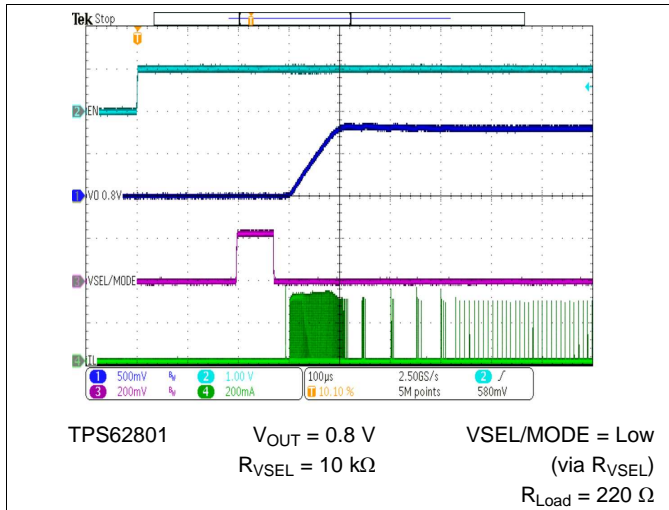

Figure 48. Startup $V_{OUT} = 0.8\text{ V}$

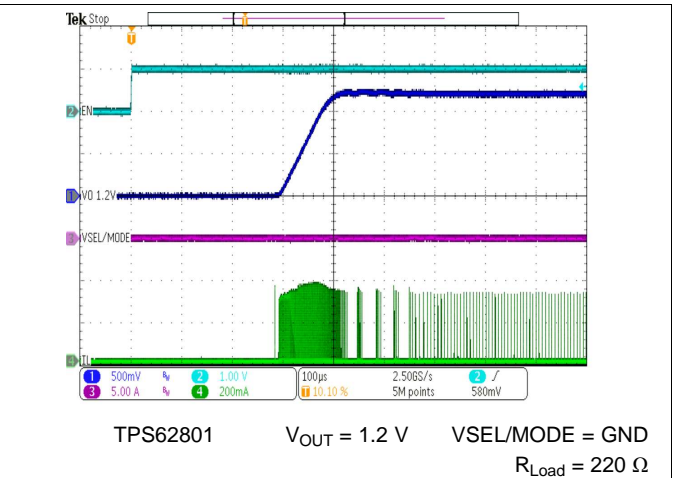

Figure 49. Startup $V_{OUT} = 1.2\text{ V}$

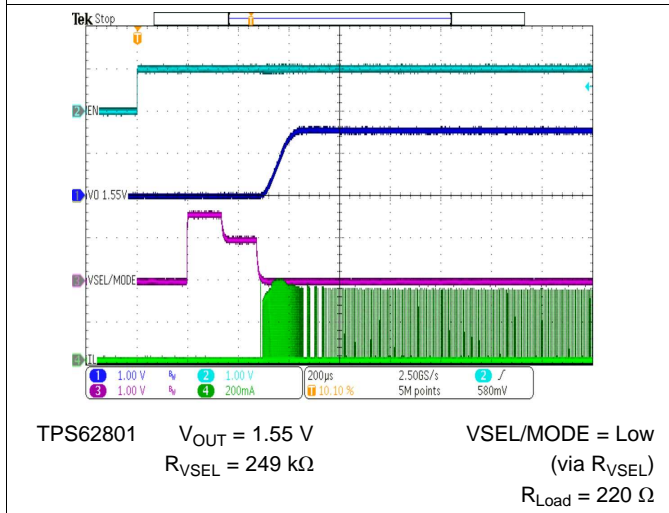

Figure 50. Startup $V_{OUT} = 1.55\text{ V}$

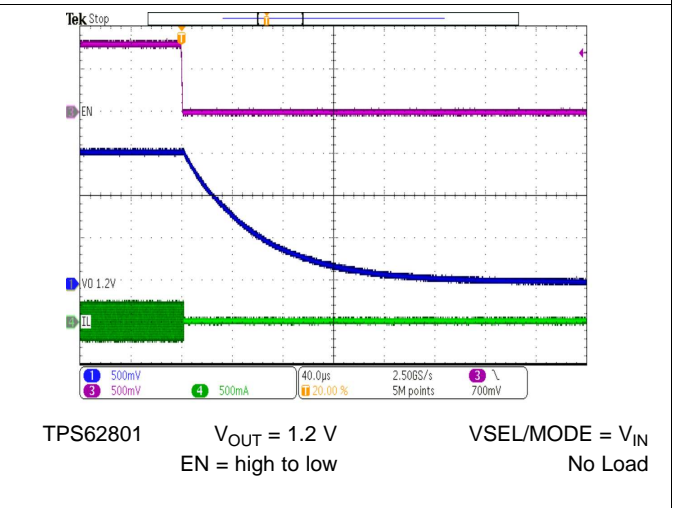

Figure 51. Output Discharge

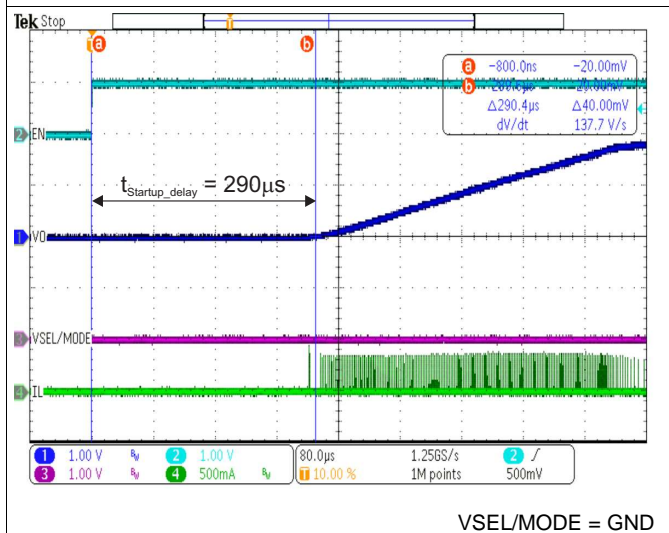

Figure 52. Startup Delay Time, $VSEL = 0$

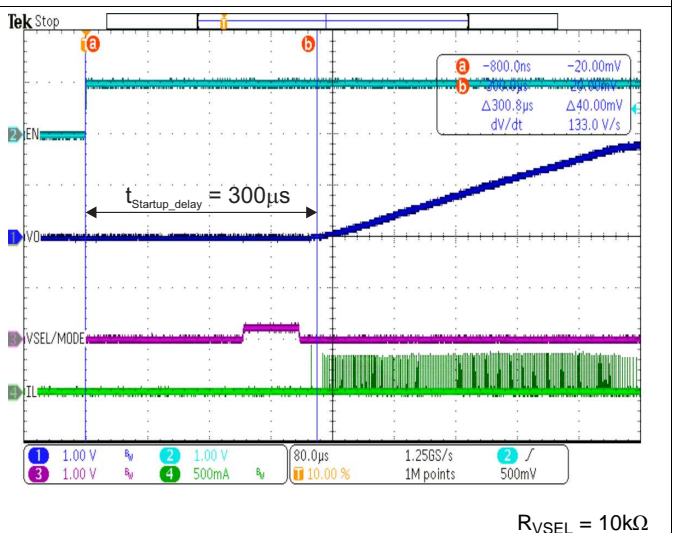
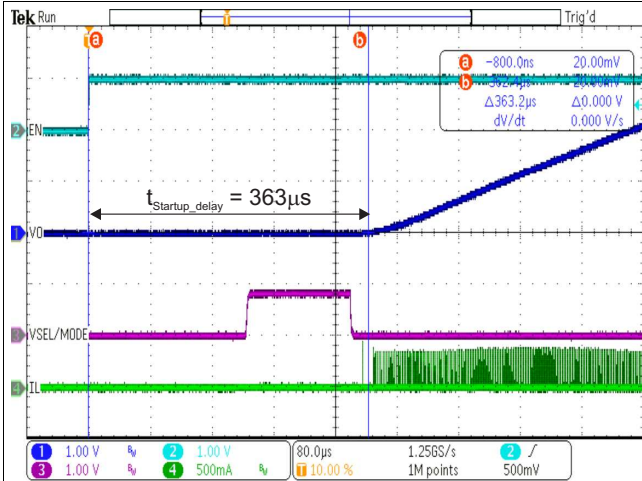
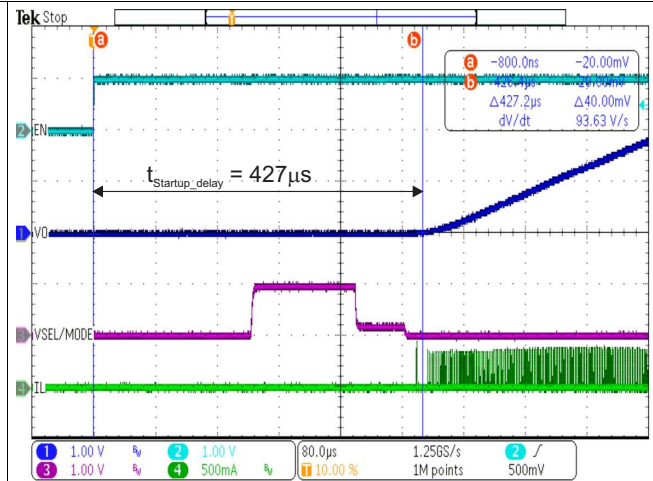

Figure 53. Startup Delay Time, $VSEL = 1$



$R_{VSEL} = 36.5k\Omega$

Figure 54. Startup Delay Time, VSEL = 7



$R_{VSEL} = 44.2k\Omega$

Figure 55. Startup Delay Time, VSEL = 8

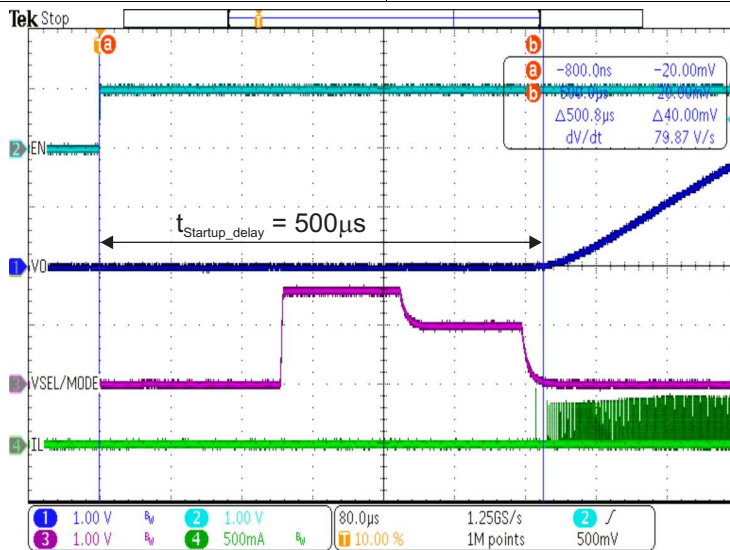

$R_{VSEL} = 249k\Omega$

Figure 56. Startup Delay Time, VSEL = 16

9.3 System Examples

This section shows additional circuits for various output voltages.

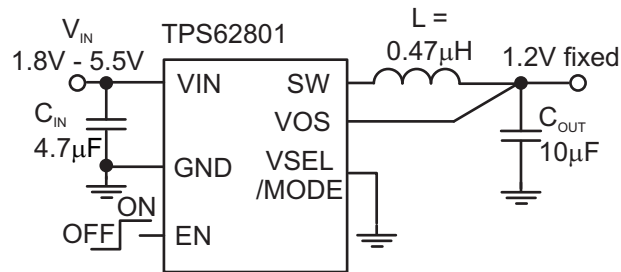

Copyright © 2017, Texas Instruments Incorporated

Figure 57. TPS62801 VSEL Connected to GND for 1.2V Fixed V_{OUT}

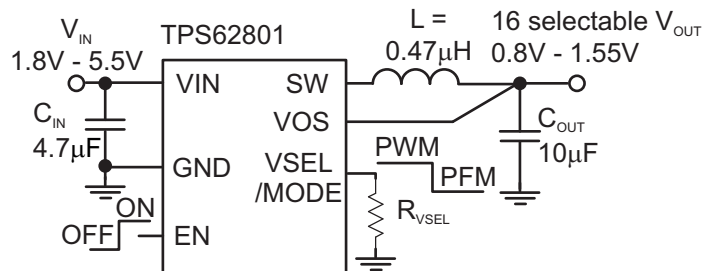

Figure 58. TPS62801 Adjustable V_{OUT} Application Circuit

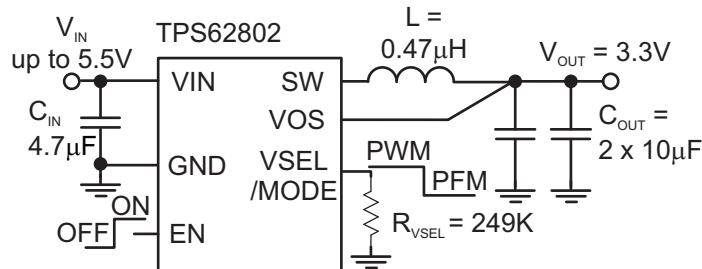
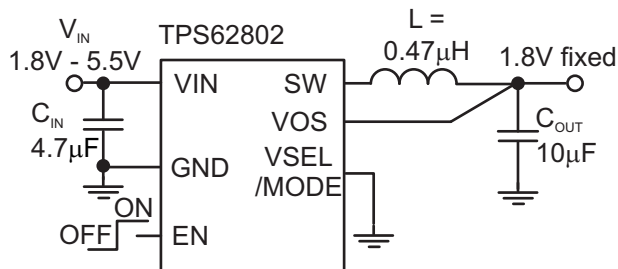
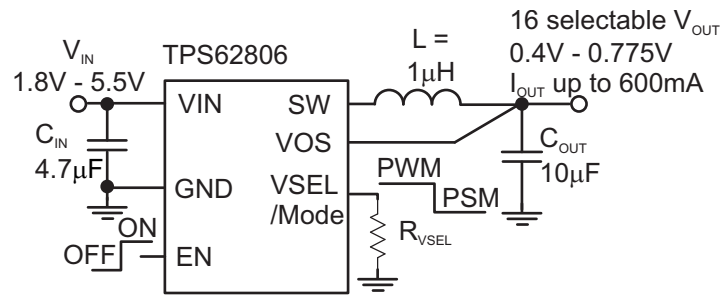
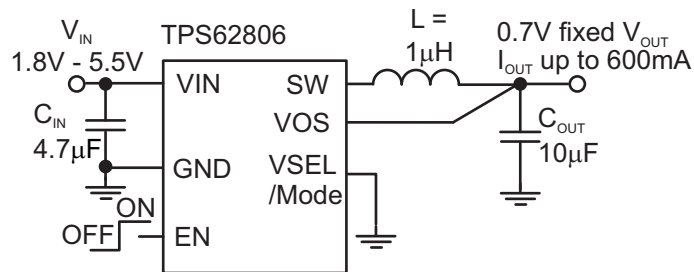

Figure 59. TPS62802 Adjustable 3.3V V_{OUT} Application Circuit



Copyright © 2017, Texas Instruments Incorporated

Figure 60. TPS62802 VSEL Connected to GND for 1.8V Fixed V_{OUT}

System Examples (continued)

Figure 61. TPS62806 Adjustable V_{OUT} Application Circuit

Figure 62. TPS62806 VSEL Connected to GND for 0.7V Fixed V_{OUT}

10 Power Supply Recommendations

The power supply must provide a current rating according to the supply voltage, output voltage and output current of the TPS6280x.

11 Layout

11.1 Layout Guidelines

The pinout of TPS6280x has been optimized to enable a single top layer PCB routing of the IC and its critical passive components such as C_{IN} , C_{OUT} and L. Furthermore, this pin out allows to connect tiny components such as 0201 (0603) size capacitors and 0402 (1005) size inductor. A solution size smaller than 5mm^2 can be achieved with a fixed output voltage.

- As for all switching power supplies, the layout is an important step in the design. Care must be taken in board layout to get the specified performance.
- It is critical to provide a low inductance, low impedance ground path. Therefore, use wide and short traces for the main current paths.
- The input capacitor should be placed as close as possible to the IC's VIN and GND pins. This is the most critical component placement.
- The VOS line is a sensitive, high impedance line and should be connected to the output capacitor and routed away from noisy components and traces (e.g. SW line) or other noise sources.

11.2 Layout Example

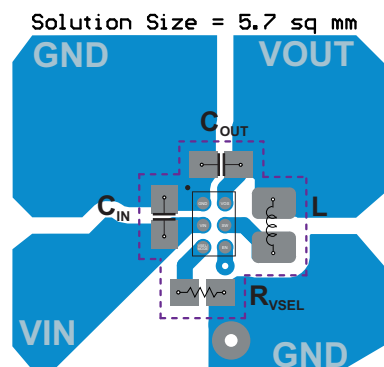

Figure 63. PCB Layout Example

12 Device and Documentation Support

12.1 Device Support

12.1.1 Third-Party Products Disclaimer

TI'S PUBLICATION OF INFORMATION REGARDING THIRD-PARTY PRODUCTS OR SERVICES DOES NOT CONSTITUTE AN ENDORSEMENT REGARDING THE SUITABILITY OF SUCH PRODUCTS OR SERVICES OR A WARRANTY, REPRESENTATION OR ENDORSEMENT OF SUCH PRODUCTS OR SERVICES, EITHER ALONE OR IN COMBINATION WITH ANY TI PRODUCT OR SERVICE.

12.2 Custom Design With WEBENCH® Tools

[Click here](#) to create a custom design using the TPS62800 device with the WEBENCH® Power Designer.

[Click here](#) to create a custom design using the TPS62801 device with the WEBENCH® Power Designer.

[Click here](#) to create a custom design using the TPS62802 device with the WEBENCH® Power Designer.

[Click here](#) to create a custom design using the TPS62806 device with the WEBENCH® Power Designer.

1. Start by entering the input voltage (V_{IN}), output voltage (V_{OUT}), and output current (I_{OUT}) requirements.
2. Optimize the design for key parameters such as efficiency, footprint, and cost using the optimizer dial.
3. Compare the generated design with other possible solutions from Texas Instruments.

The WEBENCH Power Designer provides a customized schematic along with a list of materials with real-time pricing and component availability.

In most cases, these actions are available:

- Run electrical simulations to see important waveforms and circuit performance
- Run thermal simulations to understand board thermal performance
- Export customized schematic and layout into popular CAD formats
- Print PDF reports for the design, and share the design with colleagues

Get more information about WEBENCH tools at www.ti.com/WEBENCH.

12.3 Related Links

The table below lists quick access links. Categories include technical documents, support and community resources, tools and software, and quick access to order now.

Table 6. Related Links

| PARTS | PRODUCT FOLDER | ORDER NOW | TECHNICAL DOCUMENTS | TOOLS & SOFTWARE | SUPPORT & COMMUNITY |
|----------|----------------------------|----------------------------|----------------------------|----------------------------|----------------------------|
| TPS62800 | Click here | Click here | Click here | Click here | Click here |
| TPS62801 | Click here | Click here | Click here | Click here | Click here |
| TPS62802 | Click here | Click here | Click here | Click here | Click here |
| TPS62806 | Click here | Click here | Click here | Click here | Click here |
| TPS62807 | Click here | Click here | Click here | Click here | Click here |
| TPS62808 | Click here | Click here | Click here | Click here | Click here |

12.4 Community Resources

The following links connect to TI community resources. Linked contents are provided "AS IS" by the respective contributors. They do not constitute TI specifications and do not necessarily reflect TI's views; see TI's [Terms of Use](#).

TI E2E™ Online Community *TI's Engineer-to-Engineer (E2E) Community*. Created to foster collaboration among engineers. At e2e.ti.com, you can ask questions, share knowledge, explore ideas and help solve problems with fellow engineers.

Design Support *TI's Design Support* Quickly find helpful E2E forums along with design support tools and

Community Resources (continued)

contact information for technical support.

12.5 Trademarks

DCS-Control, E2E are trademarks of Texas Instruments.

Topology is a trademark of others.

All other trademarks are the property of their respective owners.

12.6 Electrostatic Discharge Caution



These devices have limited built-in ESD protection. The leads should be shorted together or the device placed in conductive foam during storage or handling to prevent electrostatic damage to the MOS gates.

12.7 Glossary

[SLYZ022](#) — *TI Glossary*.

This glossary lists and explains terms, acronyms, and definitions.

13 Mechanical, Packaging, and Orderable Information

The following pages include mechanical, packaging, and orderable information. This information is the most current data available for the designated devices. This data is subject to change without notice and revision of this document. For browser-based versions of this data sheet, refer to the left-hand navigation.

PACKAGING INFORMATION

| Orderable Device | Status (1) | Package Type | Package Drawing | Pins | Package Qty | Eco Plan (2) | Lead/Ball Finish (6) | MSL Peak Temp (3) | Op Temp (°C) | Device Marking (4/5) | Samples |
|------------------|---------------|--------------|-----------------|------|-------------|-------------------------|-------------------------|----------------------|--------------|-------------------------|-------------------------|
| TPS62800YKAR | ACTIVE | DSBGA | YKA | 6 | 3000 | Green (RoHS & no Sb/Br) | SAC396 SNAGCU | Level-1-260C-UNLIM | -40 to 125 | - | Samples |
| TPS62801YKAR | ACTIVE | DSBGA | YKA | 6 | 3000 | Green (RoHS & no Sb/Br) | SAC396 | Level-1-260C-UNLIM | -40 to 125 | + | Samples |
| TPS62801YKAT | ACTIVE | DSBGA | YKA | 6 | 250 | Green (RoHS & no Sb/Br) | SAC396 | Level-1-260C-UNLIM | -40 to 125 | + | Samples |
| TPS62802YKAR | ACTIVE | DSBGA | YKA | 6 | 3000 | Green (RoHS & no Sb/Br) | SAC396 | Level-1-260C-UNLIM | -40 to 125 | X | Samples |
| TPS62802YKAT | ACTIVE | DSBGA | YKA | 6 | 250 | Green (RoHS & no Sb/Br) | SAC396 | Level-1-260C-UNLIM | -40 to 125 | X | Samples |
| TPS62806YKAR | ACTIVE | DSBGA | YKA | 6 | 3000 | Green (RoHS & no Sb/Br) | SAC396 | Level-1-260C-UNLIM | -40 to 125 | J | Samples |
| TPS62806YKAT | ACTIVE | DSBGA | YKA | 6 | 250 | Green (RoHS & no Sb/Br) | SAC396 | Level-1-260C-UNLIM | -40 to 125 | J | Samples |
| TPS62807YKAR | ACTIVE | DSBGA | YKA | 6 | 3000 | Green (RoHS & no Sb/Br) | SAC396 | Level-1-260C-UNLIM | -40 to 125 | L | Samples |
| TPS62807YKAT | ACTIVE | DSBGA | YKA | 6 | 250 | Green (RoHS & no Sb/Br) | SAC396 | Level-1-260C-UNLIM | -40 to 125 | L | Samples |
| TPS62808YKAR | ACTIVE | DSBGA | YKA | 6 | 3000 | Green (RoHS & no Sb/Br) | SAC396 | Level-1-260C-UNLIM | -40 to 125 | V | Samples |

(1) The marketing status values are defined as follows:

ACTIVE: Product device recommended for new designs.

LIFEBUY: TI has announced that the device will be discontinued, and a lifetime-buy period is in effect.

NRND: Not recommended for new designs. Device is in production to support existing customers, but TI does not recommend using this part in a new design.

PREVIEW: Device has been announced but is not in production. Samples may or may not be available.

OBSOLETE: TI has discontinued the production of the device.

(2) **RoHS:** TI defines "RoHS" to mean semiconductor products that are compliant with the current EU RoHS requirements for all 10 RoHS substances, including the requirement that RoHS substance do not exceed 0.1% by weight in homogeneous materials. Where designed to be soldered at high temperatures, "RoHS" products are suitable for use in specified lead-free processes. TI may reference these types of products as "Pb-Free".

RoHS Exempt: TI defines "RoHS Exempt" to mean products that contain lead but are compliant with EU RoHS pursuant to a specific EU RoHS exemption.

Green: TI defines "Green" to mean the content of Chlorine (Cl) and Bromine (Br) based flame retardants meet JS709B low halogen requirements of <=1000ppm threshold. Antimony trioxide based flame retardants must also meet the <=1000ppm threshold requirement.

(3) MSL, Peak Temp. - The Moisture Sensitivity Level rating according to the JEDEC industry standard classifications, and peak solder temperature.

(4) There may be additional marking, which relates to the logo, the lot trace code information, or the environmental category on the device.

(5) Multiple Device Markings will be inside parentheses. Only one Device Marking contained in parentheses and separated by a "~" will appear on a device. If a line is indented then it is a continuation of the previous line and the two combined represent the entire Device Marking for that device.

(6) Lead/Ball Finish - Orderable Devices may have multiple material finish options. Finish options are separated by a vertical ruled line. Lead/Ball Finish values may wrap to two lines if the finish value exceeds the maximum column width.

Important Information and Disclaimer:The information provided on this page represents TI's knowledge and belief as of the date that it is provided. TI bases its knowledge and belief on information provided by third parties, and makes no representation or warranty as to the accuracy of such information. Efforts are underway to better integrate information from third parties. TI has taken and continues to take reasonable steps to provide representative and accurate information but may not have conducted destructive testing or chemical analysis on incoming materials and chemicals. TI and TI suppliers consider certain information to be proprietary, and thus CAS numbers and other limited information may not be available for release.

In no event shall TI's liability arising out of such information exceed the total purchase price of the TI part(s) at issue in this document sold by TI to Customer on an annual basis.

TAPE AND REEL INFORMATION

QUADRANT ASSIGNMENTS FOR PIN 1 ORIENTATION IN TAPE

*All dimensions are nominal

| Device | Package Type | Package Drawing | Pins | SPQ | Reel Diameter (mm) | Reel Width W1 (mm) | A0 (mm) | B0 (mm) | K0 (mm) | P1 (mm) | W (mm) | Pin1 Quadrant |
|--------------|--------------|-----------------|------|------|--------------------|--------------------|---------|---------|---------|---------|--------|---------------|
| TPS62800YKAR | DSBGA | YKA | 6 | 3000 | 178.0 | 8.4 | 0.81 | 1.16 | 0.46 | 4.0 | 8.0 | Q1 |
| TPS62801YKAR | DSBGA | YKA | 6 | 3000 | 178.0 | 8.4 | 0.81 | 1.16 | 0.46 | 4.0 | 8.0 | Q1 |
| TPS62801YKAT | DSBGA | YKA | 6 | 250 | 178.0 | 8.4 | 0.81 | 1.16 | 0.46 | 4.0 | 8.0 | Q1 |
| TPS62802YKAR | DSBGA | YKA | 6 | 3000 | 178.0 | 8.4 | 0.81 | 1.16 | 0.46 | 4.0 | 8.0 | Q1 |
| TPS62806YKAR | DSBGA | YKA | 6 | 3000 | 178.0 | 8.4 | 0.81 | 1.16 | 0.46 | 4.0 | 8.0 | Q1 |
| TPS62806YKAT | DSBGA | YKA | 6 | 250 | 178.0 | 8.4 | 0.81 | 1.16 | 0.46 | 4.0 | 8.0 | Q1 |
| TPS62807YKAR | DSBGA | YKA | 6 | 3000 | 178.0 | 8.4 | 0.81 | 1.16 | 0.46 | 4.0 | 8.0 | Q1 |
| TPS62807YKAT | DSBGA | YKA | 6 | 250 | 178.0 | 8.4 | 0.81 | 1.16 | 0.46 | 4.0 | 8.0 | Q1 |
| TPS62808YKAR | DSBGA | YKA | 6 | 3000 | 178.0 | 8.4 | 0.81 | 1.16 | 0.46 | 4.0 | 8.0 | Q1 |

TAPE AND REEL BOX DIMENSIONS

*All dimensions are nominal

| Device | Package Type | Package Drawing | Pins | SPQ | Length (mm) | Width (mm) | Height (mm) |
|--------------|--------------|-----------------|------|------|-------------|------------|-------------|
| TPS62800YKAR | DSBGA | YKA | 6 | 3000 | 220.0 | 220.0 | 35.0 |
| TPS62801YKAR | DSBGA | YKA | 6 | 3000 | 220.0 | 220.0 | 35.0 |
| TPS62801YKAT | DSBGA | YKA | 6 | 250 | 220.0 | 220.0 | 35.0 |
| TPS62802YKAR | DSBGA | YKA | 6 | 3000 | 220.0 | 220.0 | 35.0 |
| TPS62806YKAR | DSBGA | YKA | 6 | 3000 | 220.0 | 220.0 | 35.0 |
| TPS62806YKAT | DSBGA | YKA | 6 | 250 | 220.0 | 220.0 | 35.0 |
| TPS62807YKAR | DSBGA | YKA | 6 | 3000 | 220.0 | 220.0 | 35.0 |
| TPS62807YKAT | DSBGA | YKA | 6 | 250 | 220.0 | 220.0 | 35.0 |
| TPS62808YKAR | DSBGA | YKA | 6 | 3000 | 220.0 | 220.0 | 35.0 |

YKA0006

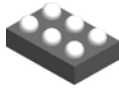

PACKAGE OUTLINE

DSBGA - 0.4 mm max height

DIE SIZE BALL GRID ARRAY

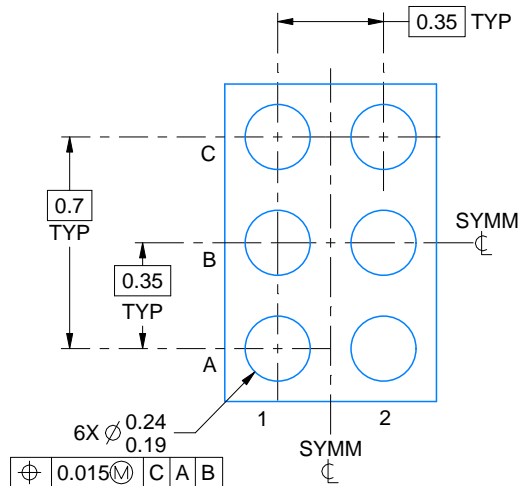
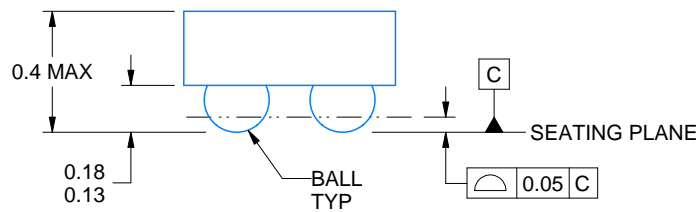
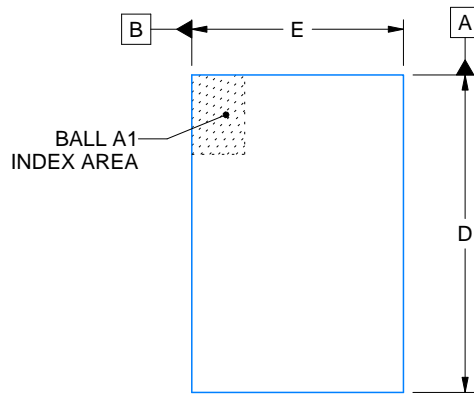

D: Max = 1.084 mm, Min = 1.024 mm
 E: Max = 0.734 mm, Min = 0.674 mm

4223607/A 03/2017

NOTES:

NanoFree is a trademark of Texas Instruments.

1. All linear dimensions are in millimeters. Any dimensions in parenthesis are for reference only. Dimensioning and tolerancing per ASME Y14.5M.
2. This drawing is subject to change without notice.
3. NanoFree™ package configuration.

EXAMPLE BOARD LAYOUT

YKA0006

DSBGA - 0.4 mm max height

DIE SIZE BALL GRID ARRAY

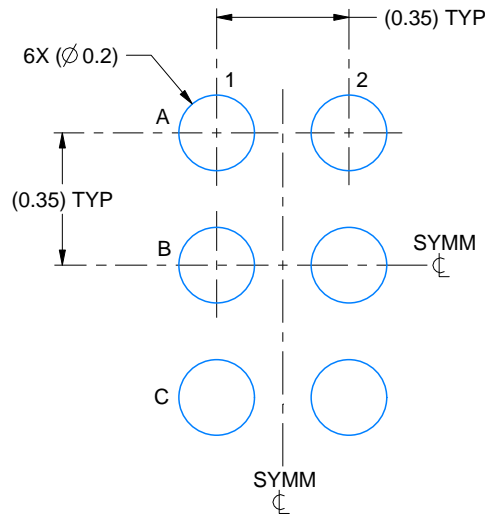

LAND PATTERN EXAMPLE
EXPOSED METAL SHOWN
SCALE:50X

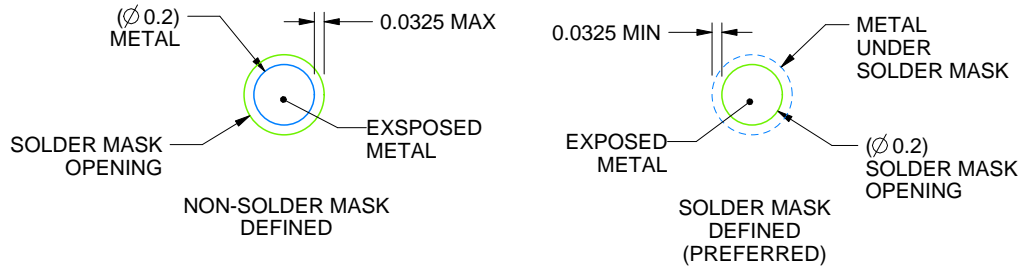

SOLDER MASK DETAILS
NOT TO SCALE

4223607/A 03/2017

NOTES: (continued)

- Final dimensions may vary due to manufacturing tolerance considerations and also routing constraints. For more information, see Texas Instruments literature number SNVA009 (www.ti.com/lit/snva009).

IMPORTANT NOTICE AND DISCLAIMER

TI PROVIDES TECHNICAL AND RELIABILITY DATA (INCLUDING DATASHEETS), DESIGN RESOURCES (INCLUDING REFERENCE DESIGNS), APPLICATION OR OTHER DESIGN ADVICE, WEB TOOLS, SAFETY INFORMATION, AND OTHER RESOURCES "AS IS" AND WITH ALL FAULTS, AND DISCLAIMS ALL WARRANTIES, EXPRESS AND IMPLIED, INCLUDING WITHOUT LIMITATION ANY IMPLIED WARRANTIES OF MERCHANTABILITY, FITNESS FOR A PARTICULAR PURPOSE OR NON-INFRINGEMENT OF THIRD PARTY INTELLECTUAL PROPERTY RIGHTS.

These resources are intended for skilled developers designing with TI products. You are solely responsible for (1) selecting the appropriate TI products for your application, (2) designing, validating and testing your application, and (3) ensuring your application meets applicable standards, and any other safety, security, or other requirements. These resources are subject to change without notice. TI grants you permission to use these resources only for development of an application that uses the TI products described in the resource. Other reproduction and display of these resources is prohibited. No license is granted to any other TI intellectual property right or to any third party intellectual property right. TI disclaims responsibility for, and you will fully indemnify TI and its representatives against, any claims, damages, costs, losses, and liabilities arising out of your use of these resources.

TI's products are provided subject to TI's Terms of Sale (www.ti.com/legal/termsofsale.html) or other applicable terms available either on ti.com or provided in conjunction with such TI products. TI's provision of these resources does not expand or otherwise alter TI's applicable warranties or warranty disclaimers for TI products.

Mailing Address: Texas Instruments, Post Office Box 655303, Dallas, Texas 75265
Copyright © 2020, Texas Instruments Incorporated