

## MAX14748

## USB Type-C Charger

### General Description

The MAX14748 USB battery charger integrates a charger detector, boost/buck converter, and Li+ battery charger with smart power selector to provide fast and safe charging of 2s Li+ battery packs.

The MAX14748 provides support for devices functioning as a UFP/DRP per the USB Type-C 1.1 standard, while also providing detection of legacy USB Battery Charging Specification, Revision 1.2 (BC1.2) compliant chargers in addition to other nonstandard chargers. The programmable Automatic Input Current Limiting (AICL) feature ensures that maximum safe current is drawn from the charging adapter.

The Li+ charger includes an automatic Smart Power Selector™ to simultaneously charge the battery and provide power to the system load. The Smart Power Selector function will supplement the system power with the battery if power from the charging adapter is insufficient. The Li+ charger features JEITA thermal monitoring and charger voltage/current reduction or charger disable.

The MAX14748 is available in a 54-bump, 0.4mm pitch, 3.97mm x 2.77mm x 0.64mm wafer-level package (WLP) and operates over the -40°C to +85°C extended temperature range.

### Applications

- Digital Imaging (DSC, DVC)
- Wireless Speakers
- Handheld Barcode Readers

**Ordering Information** appears at end of data sheet.

### Benefits and Features

- Minimize Power Management Footprint Through High Integration
  - 13mΩ (typ) Integrated Battery To System Switch
  - Thermal Current Limiting
  - DC-DC Converter with Boost and Reverse Buck
  - High Efficiency
    - 92% in Boost Mode at 1A Output Current and 7.4V Battery Voltage
    - 94% in Reverse Buck Mode at 500mA Output
  - Internal USB Switch for USB D+/D- Data Lines
- Easy-to-Implement Li+ Battery Charging
  - Charges 2s Li-Ion Batteries from Legacy 5V USB Adapters
    - 15W Input Power with 3A Type-C Adapter
    - 7.5W Input Power with DCP Adapter
    - 1A System/Charge Current From DCP Adapter
    - 2A System/Charge Current From 3A Type-C Adapter
  - DRP Mode USB Type-C Specification, Rev 1.1 Compliant
  - UFP Mode USB Type-C Specification, Rev 1.1 Support
  - VCONN and Super-Speed Multiplexer Logic Controls
  - Non-Standard DCP Detection
  - USB Battery Charging Specification, Rev 1.2 Compliant
- Automatic Input Current Limit (AICL) Power Management
- Support Weak/Dead Batteries Detection
  - Smart Power Selector
  - Thermistor Monitor
- Various Protection Features
  - 28V Integrated Overvoltage Protection
  - JEITA Charge Protection
  - ±15kV ESD Protection on USB Adapter Pins

Smart Power Selector is a trademark of Maxim Integrated Products, Inc.

### Absolute Maximum Ratings

Voltages Referenced to GND

CHGIN .....	-0.3V to +30V
BST .....	-0.3V to +16V
SYS to BAT .....	-0.3V to +12V
BAT, SYS .....	-0.3V to +12V
BYP to CHGIN .....	-30V to +0.3V
BYP, THM, INT, SYSOK, FLTIN, FSUS, LED, SDA, SCL .....	-0.3V to 6V
COMP, SET .....	-0.3V to V <sub>CCINT</sub> + 0.3V
CC1, CC2, TDN, TDP, CDN, CDP, V <sub>CONN</sub> .....	-0.3V to +6V
CC1, CC2, in fault mode through a 10k resistor ..	-0.3V to +20V
CDIR .....	-0.3V to +6V
VTPU (VTPU-TPU switch open) .....	-0.3V to V <sub>CCINT</sub> + 0.3V
TPU (VTPU-TPU switch open) .....	-0.3V to 6 or VTPU + 0.3V
VTPU, TPU Maximum Current (VTPU-TPU switch closed) .....	-100mA to +100mA
BVCEN .....	-0.3V to V <sub>CCINT</sub> + 0.3V

SFOUT, V <sub>CCINT</sub> , BREG .....	-0.3V to min ((V <sub>CHGIN</sub> + 0.3), 6)V
LX .....	-0.3V to V <sub>SYS</sub> + 0.3V
NVP .....	-0.3V to +30V
AGND, DGND, PGND, GND .....	-0.3V to +0.3V
Continuous Current into	
CHGIN, SYS .....	+6.4A
BAT .....	+4.8A
Any Other Terminal .....	+100mA
Continuous Power Dissipation (multilayer board at +70°C): 9 x 6 Array 54-Bump, 3.97mm x 2.77mm 0.4mm Pitch WLP (derate 24.46mW/°C) .....	1.957W
Operating Temperature Range .....	-40°C to +85°C
Junction Temperature .....	+150°C
Storage Temperature Range .....	-65°C to +150°C
Lead Temperature (soldering, 10s) .....	+300°C
Soldering Temperature (reflow) .....	+260°C

Stresses beyond those listed under "Absolute Maximum Ratings" may cause permanent damage to the device. These are stress ratings only, and functional operation of the device at these or any other conditions beyond those indicated in the operational sections of the specifications is not implied. Exposure to absolute maximum rating conditions for extended periods may affect device reliability.

### Package Information

<b>PACKAGE TYPE: 54 WLP</b>	
Package Code	W151G2+1
Outline Number	<a href="#">21-100122</a>
Land Pattern Number	Refer to <a href="#">Application Note 1891</a>
<b>THERMAL RESISTANC, FOUR-LAYER BOARD</b>	
Junction to Ambient (θ <sub>JA</sub> )	40.88°C/W

For the latest package outline information and land patterns (footprints), go to [www.maximintegrated.com/packages](http://www.maximintegrated.com/packages). Note that a "+", "#", or "-" in the package code indicates RoHS status only. Package drawings may show a different suffix character, but the drawing pertains to the package regardless of RoHS status.

Package thermal resistances were obtained using the method described in JEDEC specification JESD51-7, using a four-layer board. For detailed information on package thermal considerations, refer to [www.maximintegrated.com/thermal-tutorial](http://www.maximintegrated.com/thermal-tutorial).

## Electrical Characteristics

( $V_{BAT} = 8.3V$ ,  $T_A = -40^{\circ}C$  to  $+85^{\circ}C$ , all registers in their default state, unless otherwise noted. Typical values are at  $V_{CHGIN} = 5.0V$ ,  $V_{BAT} = 7.4V$ ,  $T_A = +25^{\circ}C$ .) (Note 1)

PARAMETER	SYMBOL	CONDITIONS	MIN	TYP	MAX	UNITS
<b>SUPPLY CURRENT</b>						
BAT Supply Current	$I_{BAT}$	$V_{CHGIN} = 0V$ or Floating, Type-C detection active		140		$\mu A$
		Low Power mode		25		$\mu A$
CHGIN Supply Current	$I_{CHG}$	$V_{CHGIN} = +5V$ , $T_A +25^{\circ}C$ , ChgEn = 0		5.3		mA
		$V_{CHGIN} = +5V$ , $T_A +25^{\circ}C$ , Suspend Mode (FSUS = High)		0.98		mA
<b>CHGIN TO BYP PATH</b>						
Allowed CHGIN Input Voltage Range	$V_{CHGIN\_RNG}$		0		28	V
CHGIN Detect Threshold	$V_{BDET}$	Rising	3.8	3.9	4.0	V
	$V_{BDET\_F}$	Falling	3.6	3.7	3.8	
CHGIN Overvoltage Threshold	$V_{OVP}$	Rising	5.59	5.66	5.72	V
	$V_{OVP\_F}$	Falling	5.56			V
	$V_{OVP\_H}$	Hysteresis		28		mV
CHGIN-BYP Resistance	$R_{CHGIN\_BYP}$	$V_{CHGIN} = 5V$		45		m $\Omega$
CHGIN-BYP Soft-Start Timeout	$t_{BYP\_SFTTO}$	If $V_{BYP}$ has not reached within 50mV of $V_{CHGIN}$ at timeout, a fault is flagged by SysFlt of register 0x02.		100		ms
CHGIN-BYP Soft-Start Current	$I_{BYP\_SFT}$			60		mA
CHGIN-BYP Soft-Start End Comparator	$V_{BYP\_SFTEND}$		15	50	80	mV
CHGIN-BYP Overload Comparator	$V_{BYP\_OVL}$		290	360	420	mV
Input Current Limit	$I_{LIM}$	SpvChgILim[4:0] = 00100		0.4		A
		SpvChgILim[4:0] = 01110		1.5		
		SpvChgILim[4:0] = 11101		3		
Input Current Limit Programming Range	$I_{LIM\_RNG}$		0.1		3	A
Input Current Limit Programming Step	$I_{LIM\_STEP}$			100		mA
<b>INTERNAL SUPPLIES</b>						
Internal $V_{CCINT}$ Regulator	$V_{CCINT}$	$V_{CHGIN} = 5V$ , boost off	4.0	4.3	4.6	V
Boost Regulator BREG	$V_{BREG}$			4.3		V
$V_{CCINT}$ UVLO Threshold	$V_{UVLO}$	$V_{CCINT}$ rising	3.1	3.4	3.7	V
		$V_{CCINT}$ falling	3.0	3.3	3.6	

### Electrical Characteristics (continued)

( $V_{BAT} = 8.3V$ ,  $T_A = -40^{\circ}C$  to  $+85^{\circ}C$ , all registers in their default state, unless otherwise noted. Typical values are at  $V_{CHGIN} = 5.0V$ ,  $V_{BAT} = 7.4V$ ,  $T_A = +25^{\circ}C$ .) (Note 1)

PARAMETER	SYMBOL	CONDITIONS	MIN	TYP	MAX	UNITS
$V_{CCINT}$ UVLO Threshold Hysteresis	$V_{UVLO\_HYS}$	Hysteresis		100		mV
SFOUT LDO Voltage	$V_{SFOUT}$	SfOutLvl = 1, $V_{CHGIN} = 6V$ , $I_{SFOUT} = 0$	3.15	3.3	3.45	V
		SfOutLvl = 1, $V_{CHGIN} = 6V$ , $I_{SFOUT} = 15mA$		2.95		
		SfOutLvl = 0, $V_{CHGIN} = 6V$ , $I_{SFOUT} = 0$	5.0	5.25	5.5	
		SfOutLvl = 0, $V_{CHGIN} = 6V$ , $I_{SFOUT} = 15mA$		4.9		
SFOUT Maximum Current	$I_{SFOUT\_MAX}$		15			mA
Current Reduce Temperature	$T_{CHG\_LIM}$			120		$^{\circ}C$
Thermal Shutdown Temperature	$T_{SHUTDOWN}$			150		$^{\circ}C$
Thermal Shutdown Hysteresis	$T_{SHUTDOWN\_H}$			20		$^{\circ}C$
BYP UVLO Threshold	$V_{BYPUVLO}$	BYPUVLO[2:0] = 000, $V_{BYP}$ falling		3.8		V
		BYPUVLO[2:0] = 001, $V_{BYP}$ falling		3.9		
		BYPUVLO[2:0] = 010, $V_{BYP}$ falling		4.0		
		BYPUVLO[2:0] = 011, $V_{BYP}$ falling		4.1		
		BYPUVLO[2:0] = 100, $V_{BYP}$ falling		4.2		
		BYPUVLO[2:0] = 101, $V_{BYP}$ falling		4.3		
		BYPUVLO[2:0] = 110, $V_{BYP}$ falling		4.4		
		BYPUVLO[2:0] = 111, $V_{BYP}$ falling		4.5		
BYP UVLO Threshold Hysteresis	$V_{BYPUVLO\_H}$			25		mV
SYS UVLO (SYSOK) Threshold	$V_{SYSUVLO}$	VPChg[2:0] = 000, $V_{SYS}$ rising		5.9		V
		VPChg[2:0] = 001, $V_{SYS}$ rising		6.0		
		VPChg[2:0] = 010, $V_{SYS}$ rising		6.1		
		VPChg[2:0] = 011, $V_{SYS}$ rising		6.2		
		VPChg[2:0] = 100, $V_{SYS}$ rising		6.3		
		VPChg[2:0] = 101, $V_{SYS}$ rising		6.4		
		VPChg[2:0] = 110, $V_{SYS}$ rising		6.5		
		VPChg[2:0] = 111, $V_{SYS}$ rising		6.6		
SYS UVLO Threshold Hysteresis	$V_{SYSUVLO\_H}$			500		mV

**Electrical Characteristics (continued)**

(V<sub>BAT</sub> = 8.3V, T<sub>A</sub> = -40°C to +85°C, all registers in their default state, unless otherwise noted. Typical values are at V<sub>CHGIN</sub> = 5.0V, V<sub>BAT</sub> = 7.4V, T<sub>A</sub> = +25°C.) (Note 1)

PARAMETER	SYMBOL	CONDITIONS	MIN	TYP	MAX	UNITS	
<b>BYP-SYS BOOST PATH</b>							
Switching Frequency	f <sub>BST_SW</sub>			0.8		MHz	
Maximum Input Current	I <sub>BST_MAX</sub>	L = 2.2μH	3			A	
Input Peak Current Limit	I <sub>BST_LIM_PK</sub>			4.5		A	
Forced Input Current Limit	I <sub>LIM_F</sub>	CurLim1Frc = 1 , CurLim1Set[4:0] =	0000	100		mA	
			00001	200			
			00010	300			
			00011	400			
			00100	405	450		495
			00101	600			
			00110	700			
			00111	800			
			01000	900			
			01001	1000			
			01010	1100			
			01011	1200			
			01100	1300			
			01101	1400			
			01110	1500			
			01111	1600			
			10000	1700			
			10001	1800			
			10010	1900			
			10011	2000			
10100	2100						
10101	2200						
10110	2300						
10111	2400						
11000	2500						
11001	2600						
11010	2700						
11011	2800						
11100	2900						
11101	3000						
11110	3100						
11111	3200						
Efficiency	EFF <sub>BST</sub>	I <sub>SYS</sub> = 1000mA, V <sub>BAT</sub> = 7.4V, L1 = Bourns SRP4012TA-2R2M		91.6		%	

### Electrical Characteristics (continued)

( $V_{BAT} = 8.3V$ ,  $T_A = -40^{\circ}C$  to  $+85^{\circ}C$ , all registers in their default state, unless otherwise noted. Typical values are at  $V_{CHGIN} = 5.0V$ ,  $V_{BAT} = 7.4V$ ,  $T_A = +25^{\circ}C$ .) (Note 1)

PARAMETER	SYMBOL	CONDITIONS	MIN	TYP	MAX	UNITS
SYS Regulation Voltage	$V_{SYS\_REG}$	Charger disabled		$V_{BAT} + 0.4$		V
		Charger in precharge, $V_{BAT} = 5V$		$V_{PCHG} + 0.4$		V
SYS Regulation Voltage Limit	$V_{SYS\_LIM}$	See Battery Charger State Diagram		$V_{SYS\_REG} - 0.2$		V
<b>BYP-SYS BUCK PATH</b>						
Switching Frequency	$f_{BK\_SW}$			0.8		MHz
Maximum Output Current	$I_{BK\_MAX}$	$L = 2.2\mu H$	500			mA
Short-Circuit Peak Current Limit	$I_{BK\_LIM}$			1.3		A
Efficiency	$EFF_{BK}$	$I_{CHGIN} = 500mA$ , $V_{BAT} = 7.4V$ , $L1 = \text{Bourns SRP4012TA-2R2M}$		94		%
Output Voltage Range	$V_{BK\_OUT\_RNG}$		4		5.5	V
Output Accuracy	$V_{BK\_OUT\_ACC}$		-1.5		+1.5	%
<b>SYS-BAT CHARGER/SWITCH CONTROLLER</b>						
BAT-to-SYS Regulation Voltage	$V_{BAT\_SYS\_ON}$	MAX14748		-20		mV
		MAX14748B		-40		
BAT-to-SYS Switch Fast Turn-On Threshold	$V_{BAT\_SYS\_OFF}$	$V_{SYS}$ falling		-100		mV
BAT-to-SYS Switch On-Resistance	$R_{BAT\_SYS}$	$I_{BAT} = 1A$		13		m $\Omega$
Charger Current Soft-Start Time	$t_{CHG\_SOFT}$			1		ms
<b>PRECHARGE</b>						
Precharge Current	$I_{PCHG}$	$IPChg[1:0] = 00$		5		% $I_{FCHG}$
		$IPChg[1:0] = 01$		10		
		$IPChg[1:0] = 10$		20		
		$IPChg[1:0] = 11$ , $R_{SET} = 20k\Omega$	27	30	33	
Prequalification Threshold	$V_{PCHG}$	$VPChg[2:0] = 000$		5.7		V
		$VPChg[2:0] = 001$		5.8		
		$VPChg[2:0] = 010$		5.9		
		$VPChg[2:0] = 011$		6.0		
		$VPChg[2:0] = 100$		6.1		
		$VPChg[2:0] = 101$		6.2		
		$VPChg[2:0] = 110$		6.3		
$VPChg[2:0] = 111$		6.4				
Prequalification Threshold Hysteresis	$V_{PCHG\_H}$			100		mV

**Electrical Characteristics (continued)**

(V<sub>BAT</sub> = 8.3V, T<sub>A</sub> = -40°C to +85°C, all registers in their default state, unless otherwise noted. Typical values are at V<sub>CHGIN</sub> = 5.0V, V<sub>BAT</sub> = 7.4V, T<sub>A</sub> = +25°C.) (Note 1)

PARAMETER	SYMBOL	CONDITIONS	MIN	TYP	MAX	UNITS
<b>FAST CHARGE</b>						
SET Current Gain Factor	K <sub>SET</sub>			10000		A/A
SET Regulation Voltage	V <sub>SET</sub>			1		V
Fast-Charge Current	I <sub>FCHG</sub>	R <sub>SET</sub> = 20kΩ	0.43	0.5	0.57	A
		R <sub>SET</sub> = 20kΩ, T = 25°C	0.475	0.5	0.525	
		R <sub>SET</sub> = 10kΩ		1		
		R <sub>SET</sub> = 4kΩ		2.5		
Fast-Charge Current Scaling	I <sub>FCHG_T</sub>	T <sub>T_IFChg</sub> [2:0] = 000		20		%I <sub>FCHG</sub>
		T <sub>T_IFChg</sub> [2:0] = 001		30		
		T <sub>T_IFChg</sub> [2:0] = 002		40		
		T <sub>T_IFChg</sub> [2:0] = 003		50		
		T <sub>T_IFChg</sub> [2:0] = 004		60		
		T <sub>T_IFChg</sub> [2:0] = 005		70		
		T <sub>T_IFChg</sub> [2:0] = 006		80		
		T <sub>T_IFChg</sub> [2:0] = 007		100		
1/2 Fast-Charge Current Comparator Threshold	I <sub>FC_HALF</sub>			50		%I <sub>FCHG</sub>
1/5 Fast-Charge Current Comparator Threshold	I <sub>FC_FIFTH</sub>			20		%I <sub>FCHG</sub>
<b>MAINTAIN CHARGE</b>						
Charge Done Qualification	I <sub>CHG_DONE</sub>	ChgDone[1:0] = 00		5		%I <sub>FCHG</sub>
		ChgDone[1:0] = 01		10		
		ChgDone[1:0] = 10, R <sub>SET</sub> = 20kΩ	18	20	22	
BAT Regulation Voltage	V <sub>BATREG</sub>	BatReg[1:0] = 00, T <sub>A</sub> = +25°C	8.258	8.3	8.342	V
		BatReg[1:0] = 00, T <sub>A</sub> = -40°C to +85°C	8.217	8.3	8.383	
		BatReg[1:0] = 01		8.4		
		BatReg[1:0] = 10		8.5		
		BatReg[1:0] = 11		8.6		
BAT Recharge Threshold	V <sub>BATRECHG</sub>	BatReChg[1:0] = 00		200		mV
		BatReChg[1:0] = 01		300		
		BatReChg[1:0] = 10		400		
		BatReChg[1:0] = 11		500		

## Electrical Characteristics (continued)

( $V_{BAT} = 8.3V$ ,  $T_A = -40^{\circ}C$  to  $+85^{\circ}C$ , all registers in their default state, unless otherwise noted. Typical values are at  $V_{CHGIN} = 5.0V$ ,  $V_{BAT} = 7.4V$ ,  $T_A = +25^{\circ}C$ .) (Note 1)

PARAMETER	SYMBOL	CONDITIONS	MIN	TYP	MAX	UNITS
<b>CHARGE TIMER</b>						
Maximum Prequalification Time	$t_{PCHG}$	PChgTmr[1:0] = 00		30		min
		PChgTmr[1:0] = 01		60		
		PChgTmr[1:0] = 10		120		
		PChgTmr[1:0] = 11		240		
Maximum Fast-Charge Time	$t_{FCHG}$	FChgTmr[1:0] = 00		75		Min
		FChgTmr[1:0] = 01		150		
		FChgTmr[1:0] = 10		300		
		FChgTmr[1:0] = 11		600		
Maintain Charge Time	$t_{TOCHG}$	MtChgTmr[1:0] = 00		0		Min
		MtChgTmr[1:0] = 01		15		
		MtChgTmr[1:0] = 10		30		
		MtChgTmr[1:0] = 11		60		
Timer Accuracy	$t_{ACC}$		-10		+10	%
Timer Extend Threshold	$P_{TIMERX}$	If charge current is reduced due to $I_{LIM}$ or $T_{DIE}$ , this is the percentage of charge current below which timer clock operates at half speed		50		%
Timer Suspend Threshold	$P_{TIMERSUS}$	If charge current is reduced due to $I_{LIM}$ or $T_{DIE}$ , this is the percentage of charge current below which timer clock pauses		20		%
<b>THERMISTOR MONITOR AND NTC DETECTION</b>						
THM Hot Threshold	T4	$V_{THM}$ falling, WarmCoolSel = 0	21.3	23.3	25.3	% $V_{TPU}$
		$V_{THM}$ falling, WarmCoolSel = 1	30.9	32.9	34.9	
THM Warm Threshold	T3	$V_{THM}$ falling, WarmCoolSel = 0	30.9	32.9	34.9	% $V_{TPU}$
		$V_{THM}$ falling, WarmCoolSel = 1	46.5	50	53.5	
THM Cool Threshold	T2	$V_{THM}$ rising, WarmCoolSel = 0 or 1	62.5	64.5	66.5	% $V_{TPU}$
THM Cold Threshold	T1	$V_{THM}$ rising, WarmCoolSel = 0 or 1	71.9	73.9	75.9	% $V_{TPU}$
THM Disable Threshold	$V_{THM\_DIS}$	$V_{THM}$ rising	91.0	93.0	95.0	% $V_{TPU}$
THM Threshold Hysteresis	$V_{THM\_DIS\_H}$			60		mV
JEITA BAT Voltage Reduction	$V_{BAT\_JEITA}$			300		mV
THM Input Leakage	$I_{THM\_LK}$		-1		+1	$\mu A$
THM Detection Time	$t_{THM\_DET}$			0.4		ms

## Electrical Characteristics (continued)

( $V_{BAT} = 8.3V$ ,  $T_A = -40^{\circ}C$  to  $+85^{\circ}C$ , all registers in their default state, unless otherwise noted. Typical values are at  $V_{CHGIN} = 5.0V$ ,  $V_{BAT} = 7.4V$ ,  $T_A = +25^{\circ}C$ .) (Note 1)

PARAMETER	SYMBOL	CONDITIONS	MIN	TYP	MAX	UNITS
<b>DIGITAL I/O (SDA, SCL, <math>\overline{FLTIN}</math>, <math>\overline{INT}</math>, SYSOK, FSUS, LED, CDIR)</b>						
Leakage Current	$I_{IO\_LK}$		-1		+1	$\mu A$
Logic Input High-Voltage	$V_{IO\_IH}$		1.4			V
Logic Input Low-Voltage	$V_{IO\_IL}$				0.5	V
Logic Output Low-Voltage	$V_{IO\_OL}$	$I_{OL} = 4mA$			0.4	V
FSUS Input Pulldown Resistance	$R_{FSUS\_PD}$			470		$k\Omega$
SDA, SCL Bus Low-Detection Current	$I_{PD}$	$V_{SDA} = V_{SCL} = 0.4V$		0.2	0.4	$\mu A$
SCL Clock Frequency	$f_{SCL}$	Note 2	0		400	kHz
Bus Free Time Between a STOP and START Condition	$t_{BUF}$		1.3			$\mu s$
START Condition (Repeated) Hold Time	$t_{HD\_SDA}$	Note 2	0.6			$\mu s$
Low Period of SCL Clock	$t_{LOW}$		1.3			$\mu s$
High Period of SCL Clock	$t_{HIGH}$		0.6			$\mu s$
Setup Time for a Repeated START Condition	$t_{SU\_STA}$		0.6			$\mu s$
Data Hold Time	$t_{HD\_DAT}$	Note 3	0		0.9	$\mu s$
Data Setup Time	$t_{SU\_DAT}$	Note 3	100			ns
Setup Time for STOP Condition	$t_{SU\_STO}$		0.6			$\mu s$
Spike Pulse Widths Suppressed by Input Filter	$t_{SP}$	Note 4		50		ns
<b>BC1.2 DETECTION</b>						
$V_{DP\_SRC}$ Voltage	$V_{DP\_SRC}/V_{SRC06}$	$I_{LOAD} = 0$ to $200\mu A$	0.5	0.6	0.7	V
$V_{DM\_SRC}$ Voltage	$V_{DM\_SRC}/V_{SRC06}$	$I_{LOAD} = 0$ to $200\mu A$	0.5	0.6	0.7	V
$V_{D33}$ Voltage	$V_{SRC33}$	$I_{LOAD} = 0$ to $365\mu A$	2.6		3.4	V
$V_{DAT\_REF}$ Voltage	$V_{DAT\_REF}$		0.25	0.32	0.4	V
$V_{LGC}$ Voltage	$V_{LGC}$		1.5	1.7	1.9	V
$I_{DM\_SINK}$ Current	$I_{DM\_SINK}/I_{DATSINK}$	0.15V to 3.6V	55	80	105	$\mu A$
$I_{DP\_SRC}$ Current	$I_{DP\_SRC}/I_{DCD}$	0V to 2.5V	7	10	13	$\mu A$

## Electrical Characteristics (continued)

( $V_{BAT} = 8.3V$ ,  $T_A = -40^{\circ}C$  to  $+85^{\circ}C$ , all registers in their default state, unless otherwise noted. Typical values are at  $V_{CHGIN} = 5.0V$ ,  $V_{BAT} = 7.4V$ ,  $T_A = +25^{\circ}C$ .) (Note 1)

PARAMETER	SYMBOL	CONDITIONS	MIN	TYP	MAX	UNITS
$R_{DM\_DWN}$ Resistor	$R_{DM\_DWN}/R_{DWN15}$		12	20	24	k $\Omega$
$I_{WEAK}$ Current	$I_{WEAK}$		0.01	0.1	0.5	$\mu A$
$V_{BUS31}$ Threshold	$V_{BUS31}$	DP and DN pins. Threshold in percent of $V_{BUS}$ voltage $4V < V_{BUS} < 5.5V$	26	31	36	%
$V_{BUS47}$ Threshold	$V_{BUS47}$	DP and DN pins. Threshold in percent of $V_{BUS}$ voltage $4V < V_{BUS} < 5.5V$	43.3	47	51.7	%
$V_{BUS64}$ Threshold	$V_{BUS64}$	DP and DN pins. Threshold in percent of $V_{BUS}$ voltage $4V < V_{BUS} < 5.5V$	57	64	71	%
Charger Detection Debounce	$t_{CDDEB}$		45	50	55	ms
Primary-to-Secondary Timer	$t_{PDSWAIT}$		27	35	39	ms
Proprietary Charger Debounce	$t_{PRDEB}$		5	7.5	10	ms
Data Contact Detect Timeout	$t_{DCDTMO}$	DCD2s = 0	700	800	900	ms
		DCD2s = 1	1.8	2.0	2.2	
DP/DN Overvoltage Debounce	$t_{OVDXDEB}$		90	100	110	$\mu s$
OVDX Comparator	$OVDX_{THRESHOLD}$	Rising	0		0.15	V
		Falling	-0.04		+0.08	
CDP/CDN Pulldown Resistor	$R_{CDP/CDN\_PD}$		3	6	12	m $\Omega$
<b>TYPE-C DETECTION</b>						
$V_{CONN}$ Switch Voltage Drop	$V_{CONN\_REQ}$	$V_{CONN} = 5.5V$ , $I_{CC\_LOAD} = 20mA$	5.5		5.6	V
$V_{CONN}$ Bulk Capacitance	$C_{VCONN}$		10		220	$\mu F$
CC Pin Operational Voltage Range	$V_{CONN\_RNG}$				5.5	V
CC Pin Voltage in DFP 3.0A Mode	$V_{CC\_PIN30}$		3.1			V
CC Pin Voltage in DFP 1.5A Mode	$V_{CC\_PIN15}$		1.85			V
CC Pin Low-Power Mode Pulldown Resistance	$R_{LPPD\_CC\_}$			170		k $\Omega$

## Electrical Characteristics (continued)

( $V_{BAT} = 8.3V$ ,  $T_A = -40^{\circ}C$  to  $+85^{\circ}C$ , all registers in their default state, unless otherwise noted. Typical values are at  $V_{CHGIN} = 5.0V$ ,  $V_{BAT} = 7.4V$ ,  $T_A = +25^{\circ}C$ .) (Note 1)

PARAMETER	SYMBOL	CONDITIONS	MIN	TYP	MAX	UNITS
CC Pin Low-Power Mode Voltage Threshold	$V_{LP\_CC\_}$	Rising		0.7		V
CC Pin Clamp Requirements	$V_{CC\_PIN\_CLAMP}$	$60\mu A \leq I_{CC\_} \leq 600\mu A$		1.1	1.32	V
CC UFP Pulldown Resistance	$R_{DUFP\_CC\_}$		4.59	5.1	5.61	k $\Omega$
CC DFP 0.5A Current Source	$I_{DFP0.5\_CC\_}$		72	80	88	$\mu A$
CC DFP 1.5A Current Source	$I_{DFP1.5\_CC\_}$		165.6	180	194.4	$\mu A$
CC DFP 3.0A Current Source	$I_{DFP3.0\_CC\_}$		303.6	330	356.4	$\mu A$
CC $R_A$ and $R_D$ Threshold	$V_{RA\_RD0.5}$	Rising	0.16	0.2	0.25	V
		Falling	0.15			
CC UFP 0.5A $R_D$ Threshold	$V_{UFP\_RD0.5}$	Rising	0.62	0.66	0.7	V
		Falling	0.61			
CC UFP 1.5A $R_D$ Threshold	$V_{UFP\_RD1.5}$	Rising	1.17	1.23	1.31	V
		Falling	1.16			
CC $V_{CONN}$ Detect Threshold	$V_{VCONN\_DET}$	Rising	2.11	2.25	2.4	V
		Falling	2.1			
CC DFP $V_{OPEN}$ Detect Threshold	$V_{DFP\_VOPEN}$	Rising	1.51	1.575	1.65	V
		Falling	1.5			
CC DFP $V_{OPEN}$ with 3.0A Detect Threshold	$V_{DFP\_VOPEN3A}$	Rising	2.46	2.6	2.75	V
		Falling	2.45			V
$V_{BUS}$ Valid	$V_{BDET}$	Rising	3.8	4.12	4.4	V
$V_{BUS}$ Valid Hysteresis	$V_{BDET\_H}$	Falling hysteresis		0.7		V
$V_{BUS}$ Discharge Value	$V_{SAFE0V}$	Falling. Voltage level where a connected UFP will find $V_{BUS}$ removed.	0.6	0.7	0.84	V
		Rising hysteresis		100		mV
CC Pin Power-Up Time	$t_{CLAMPSWAP}$	The maximum time allowed from removal of voltage clamp to attachment of the 5.1k resistor			15	ms
Type-C CC Pin Detection Debounce	$t_{CCDEB}$		100		200	ms
Type-C Debounce	$t_{PDDEB}$		10		20	ms

## Electrical Characteristics (continued)

( $V_{BAT} = 8.3V$ ,  $T_A = -40^{\circ}C$  to  $+85^{\circ}C$ , all registers in their default state, unless otherwise noted. Typical values are at  $V_{CHGIN} = 5.0V$ ,  $V_{BAT} = 7.4V$ ,  $T_A = +25^{\circ}C$ .) (Note 1)

PARAMETER	SYMBOL	CONDITIONS	MIN	TYP	MAX	UNITS
Type-C Quick Debounce	$t_{QDEB}$		0.9	1	1.9	ms
$V_{BUS}$ Debounce	$t_{VBDEB}$		9	10	11	ms
$V_{SAFE0V}$ Debounce	$t_{VSAFE0VDEB}$		9	10	11	ms
Type-C Error Recovery Delay	$t_{ERRORRECOVERY}$		25			ms
Type-C DRP Toggle Time	$t_{DRP}$		50		100	ms
Duty Cycle of DRP Swap	$D_{DRP}$	Duty cycle of UFP to DFP role swap	30		70	%
DRP Transition Time	$t_{DRPTRAN}$	Time a role swap from DFP to UFP or reverse is completed			1	ms
DRP Lock Time	$t_{DRPLOCK}$	DRP Lock wait time before transition to unattached state	100		150	ms
$V_{CONN}$ Enable Time	$t_{VCONNON}$	Time from when $V_{BUS}$ is supplied in DFP mode in state Attach.DFP. DRPWait			10	ms
$V_{CONN}$ Disable Time	$t_{VCONNOFF}$	Time from UFP detached or as directed by I <sup>2</sup> C command until $V_{CONN}$ is removed			35	ms
CC Pin Current Change Time	$t_{SINKADJ}$	Time from CC pin changes state in UFP mode until current drawn from DFP reaches new value			60	ms
$V_{BUS}$ On-Time	$t_{VBUSON}$	Time from UFP is attached until $V_{BUS}$ On			275	ms
$V_{BUS}$ Off-Time	$t_{VBUSOFF}$	Time from UFP is detached until $V_{BUS}$ reaches $V_{SAFE0V}$			650	ms
BVCEN Output Low-Voltage	$V_{BVCEN\_OL}$	$I_{SINK} = 1mA$			0.4	V
BVCEN Output High-Voltage	$V_{BVCEN\_OH}$	$I_{SOURCE} = 1mA$	$V_{CCINT}$ -0.4			V

**Note 1:** All devices are 100% production tested at  $T_A = +25^{\circ}C$ . Limits over the operating temperature range are guaranteed by design and characterization.

**Note 2:**  $f_{SCL}$  must meet the minimum clock low time plus the rise/fall times.

**Note 3:** The maximum  $t_{HD:DAT}$  has to be met only if the device does not stretch the low period ( $t_{LOW}$ ) of the SCL signal.

**Note 4:** Filters on SDA and SCL suppress noise spikes at the input buffers and delay the sampling instant.

### Typical Operating Characteristics

( $V_{BAT} = 8.5V$ ,  $T_A = -20^{\circ}C$  to  $+70^{\circ}C$ , all registers in their default state, unless otherwise noted. Typical values are at  $V_{CHGIN} = 5.0V$ ,  $V_{BAT} = 7.4V$ ,  $T_A = +25^{\circ}C$ .)

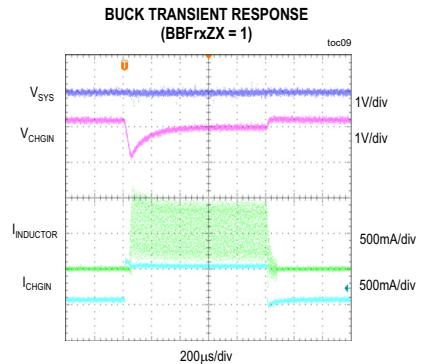
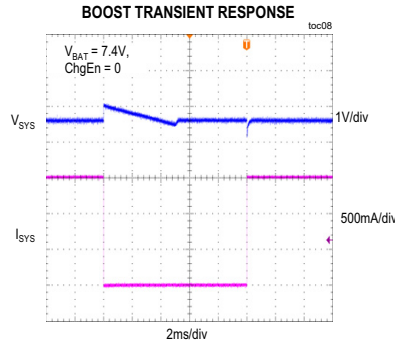
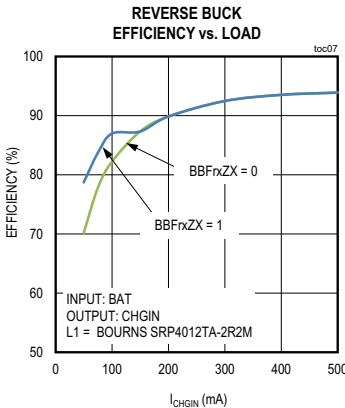
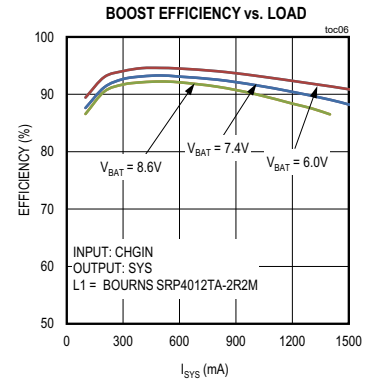
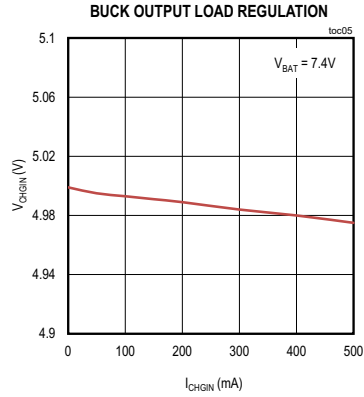
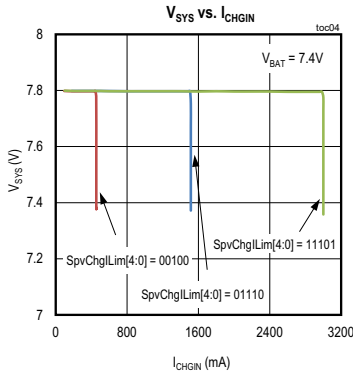
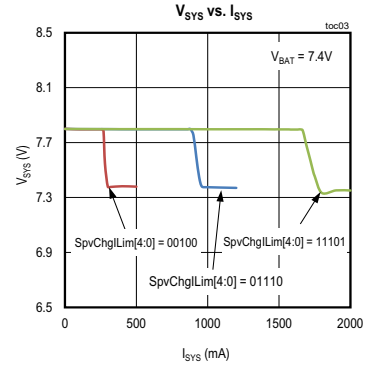
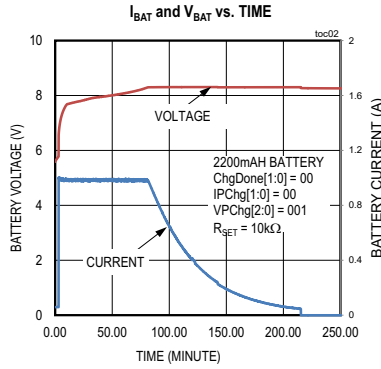
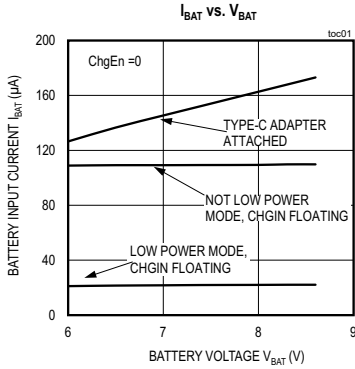

Typical Operating Characteristics (continued)

( $V_{BAT} = 8.5V$ ,  $T_A = -20^{\circ}C$  to  $+70^{\circ}C$ , all registers in their default state, unless otherwise noted. Typical values are at  $V_{CHGIN} = 5.0V$ ,  $V_{BAT} = 7.4V$ ,  $T_A = +25^{\circ}C$ .)

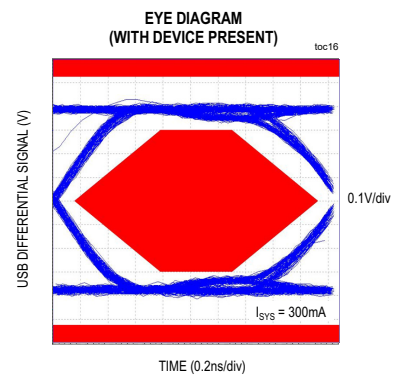
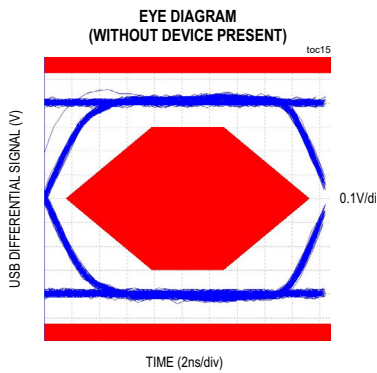
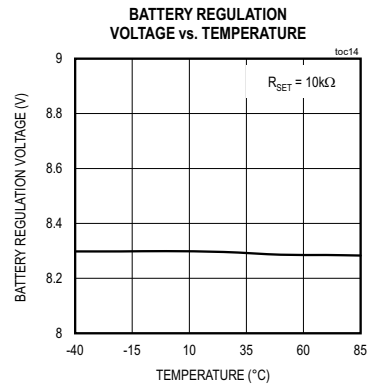
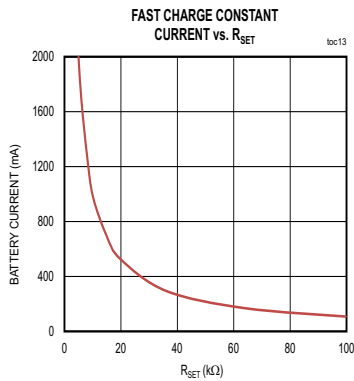
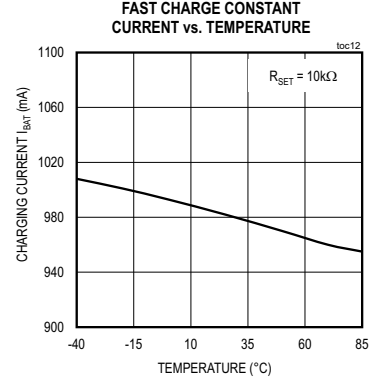
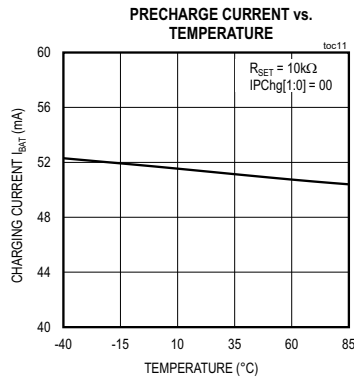
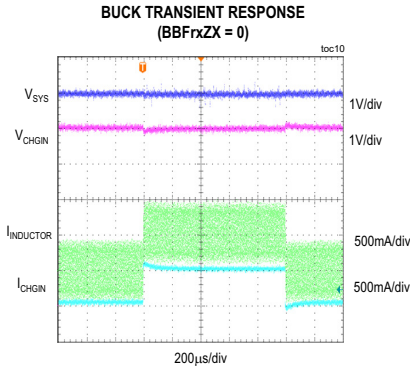

**Bump Configuration**

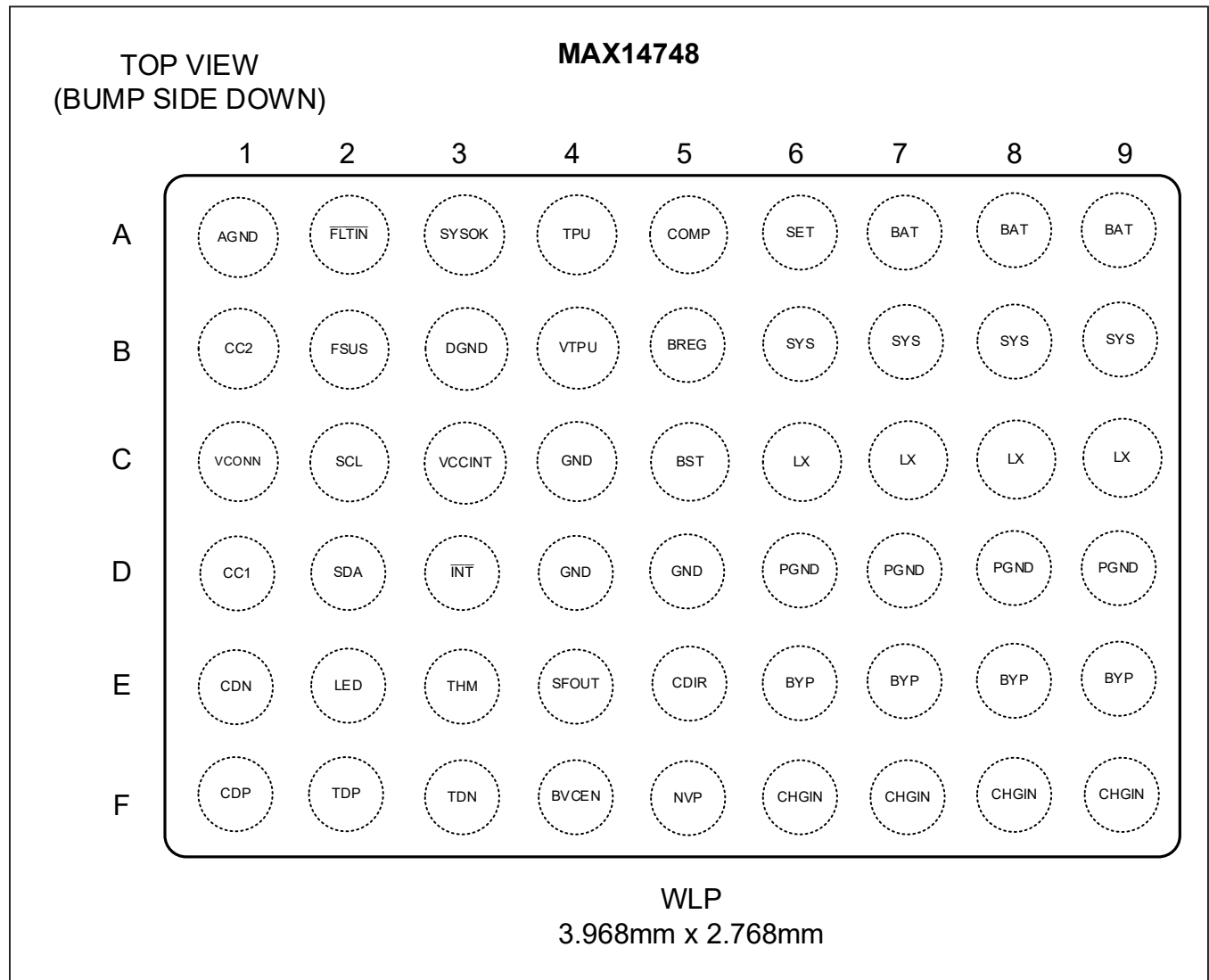

## Bump Descriptions

BUMP	NAME	FUNCTION
A1	AGND	Analog Ground.
A2	$\overline{\text{FLTIN}}$	Charger Fault Input. Logic-low on this pin forces the charger into a fault state and generates an interrupt. See Register 0x35 description for more information. Connect to digital I/O supply if not used.
A3	SYSOK	Open-Drain Status Output of SYS Regulation. When $V_{\text{SYS}}$ is above the SYS UVLO threshold and Boost is active, this output is high-impedance. When $V_{\text{SYS}}$ is below the SYS UVLO threshold, this output is low. Leave unconnected if not used.
A4	TPU	High-Side of Internal Resistor for THM Detection. Connect a 10k resistor between this pin and THM.
A5	COMP	Buck/Boost Converter Compensation Connection. Connect a 3.9nF capacitor for internal Buck/Boost compensation
A6	SET	External Resistor Connection for Fast Charge Current Setting. Connect a resistor to this pin to set the fast charge current. Other charge currents are set as a proportion of fast charge current based on I <sup>2</sup> C register settings.
A7–A9	BAT	Battery Connection. Connect a 2s Li-ion+ battery from BAT to GND. Bypass to PGND with a parallel combination of a 0.1 $\mu$ F capacitor and an effective 10 $\mu$ F - 30 $\mu$ F capacitor. Keep the capacitors as close to BAT as possible and keep the stray inductance and resistance of the trace from BAT to the battery terminal as low as possible.
B1	CC2	USB Type-C CC2. Connect to CC2 on USB Type-C connector.
B2	FSUS	Force Suspend Input. Logic-high on this pin causes the input limiter to open and input current from CHGIN is reduced to zero. This pin is internally pulled to GND through a 470k $\Omega$ (typ) resistor and has no effect if FSUSMsk = 1.
B3	DGND	Digital Ground.
B4	V <sub>TPU</sub>	External Voltage Input for TPU connection. Connect to external supply or V <sub>CCINT</sub> .
B5	BREG	Bypass for Internal Switching Converter Supply. Bypass with 1 $\mu$ F capacitor to AGND.
B6–B9	SYS	System Load Connection. Connect SYS to the system load. Bypass to PGND with a parallel combination of a 0.1 $\mu$ F capacitor and an effective 22 $\mu$ F capacitor. (Note: there is a diode between SYS and BAT)
C1	V <sub>CONN</sub>	External V <sub>CONN</sub> Supply Input. Leave unconnected if not used.
C2	SCL	I <sup>2</sup> C Serial Clock Input. Connect an external pull-up resistor.
C3	V <sub>CCINT</sub>	Bypass For Internal Analog Supply. Bypass with 1 $\mu$ F capacitor to GND.
C4, D4, D5	GND	Ground.
C5	BST	Charge Pump Connection. Connect a 0.1 $\mu$ F capacitor between BST and LX.
C6, C7, C8, C9	LX	Switching Node of Boost Converter. Connect a 1.5 $\mu$ H or 2.2 $\mu$ H inductor between LX and BYP. See <i>Applications Information</i> section for more details.
D1	CC1	USB Type-C CC1. Connect to CC1 on USB Type-C connector.
D2	SDA	I <sup>2</sup> C Serial Data Input/Output. Connect an external pullup resistor.
D3	$\overline{\text{INT}}$	Active-Low, Open-Drain Interrupt Output. Connect an external pullup resistor.
D6, D7, D8, D9	PGND	Power Ground.

### Bump Descriptions (continued)

BUMP	NAME	FUNCTION
E1	CDN	USB Connector D-Input. Leave unconnected if not used.
E2	LED	LED Charging Status Indicator. Open-drain output indicating battery charging status. When LEDAuto = 1 and a temperature fault is detected, the output is pulsed at 50% duty cycle for a period of 1.5s. When a charge timer expires or SysFlt fault occurs, LED is pulsed at 50% for a period of 0.15s. When LEDAuto = 0, the open-drain output is controlled by the LEDCtrl bit. Connect this pin to GND if unused.
E3	THM	Battery Temperature Thermistor Measurement Connection. This pin is used for NTC thermistor presence detection and JEITA compliant temperature control.
E4	SFOUT	Output of overvoltage protected LDO powered from CHGIN. Bypass SFOUT with a 1 $\mu$ F ceramic capacitor to GND.
E5	CDIR	USB Cable Orientation Open-drain Output. When CC1 is active, this output is pulled low. Otherwise, this output is high-impedance. Leave unconnected if not used.
E6–E9	BYP	Bypass Connection. Bypass to PGND with a parallel combination of a 0.1 $\mu$ F capacitor and an effective 10 $\mu$ F capacitor.
F1	CDP	USB Connector D+ Input. Leave unconnected if not used.
F2	TDP	USB Transceiver D+ Connection. Connect TDP to device microprocessor USB transceiver D+ line. Leave unconnected if not used.
F3	TDN	USB Transceiver D- Connection. Connect TDN to device microprocessor USB transceiver D- line. Leave unconnected if not used.
F4	BVCEN	External V <sub>CONN</sub> Supply Enable Output. Push-pull output between V <sub>CCINT</sub> and GND. Leave unconnected if not used.
F5	NVP	Negative Voltage PFET Gate Control. Leave unconnected if not used.
F6–F9	CHGIN	USB Charger Input. Bypass this pin with a 1 $\mu$ F capacitor to PGND.

**Note:** All capacitance values listed in this document refer to effective capacitance. Be sure to specify capacitors that will meet these requirements under typical system operating conditions taking into consideration the effects of voltage and temperature.

Block Diagram

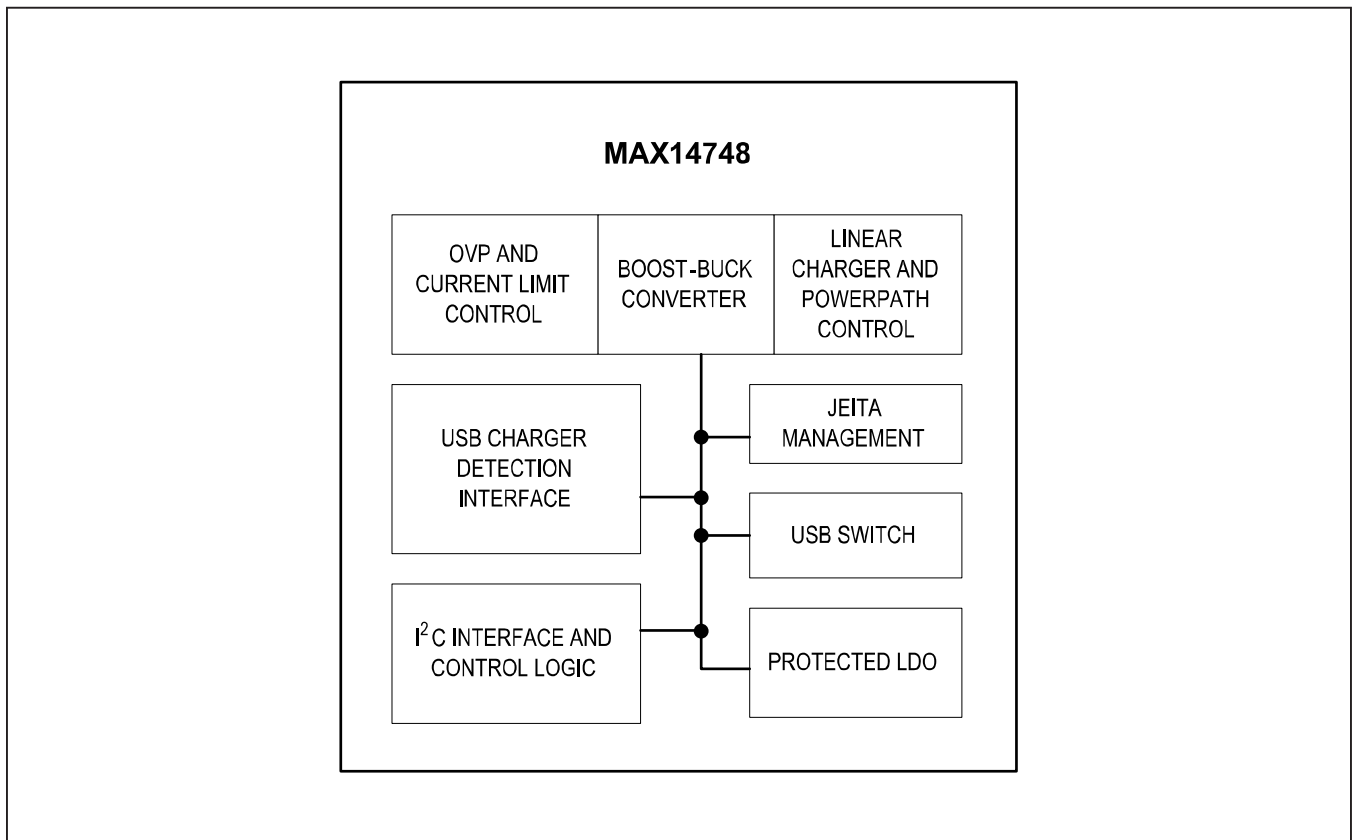

## Detailed Description

The MAX14748 is a battery charger with a Smart Power Selector that safely charges two Li+ cell in accordance with JEITA specifications\*.

### Input OVP

The MAX14748 CHGIN input is protected by an internal N-channel FET. The device monitors the voltage at CHGIN and, if CHGIN is greater than  $V_{OVP}$ , switches off the internal FET to prevent damage to the device. If  $V_{CHGIN}$  is above the overvoltage threshold or below the USB valid voltage threshold, the MAX14748 enters overvoltage lockout (OVLO). During OVLO, the internal circuits remain powered, the SYSOK pin is high-impedance, and an interrupt is asserted. During OVLO, the charger turns off and the system load switch closes, allowing the battery to power SYS.

### Negative Voltage Protection (NVP)

The MAX14748 provides a gate protection circuit for an external PFET that protects against negative voltages on  $V_{BUS}$ . NVP pin drives the gate of the external PFET. If a negative voltage is present on  $V_{BUS}$  (e.g., by a backwards connector) the NVP turns off the external PFET, therefore providing negative voltage protection.

### Low Power Mode

The MAX14748 features a Low Power mode, which reduces the battery current consumption from 25 $\mu$ A to 140 $\mu$ A. To enter Low Power mode, write 1 to LowPowEn (Register 0x33[7]). To manually exit Low Power mode, set LowPowAbort (Register 0x33[1]) to 1. If a DFP pullup connect to CC1/CC2 is detected, the device automatically exits Low Power mode and resumes normal operations.

### Input Current Limiter

The primary function of the input limiter is supplying power from the external adapter at CHGIN to the system load and battery charger. In addition, it performs several other functions to optimize use of the available power efficiently and safely, including:

- 1) CHGIN Input Current Limiting: The CHGIN input current is limited to prevent input overload. The current limit can be automatically selected through charger detection to match the capabilities of the source. The result is indicated by SpvChgLim[4:0] in register 0x22. See [Table 1a](#) for more details. It can also be manually set through CurLim1Frc and CurLim1Set[4:0] in register 0x21. [Figure 1](#) illustrates how the current limit setting is selected.
- 2) Thermal Limiting: In case the die temperature exceeds the normal limit ( $T_{CHG\_LIM}$ ), the MAX14748 will attempt to limit temperature increase by reducing the input current at CHGIN. In this condition, the system load has priority over charger current, so the input current is first reduced by lowering the charge current. If the junction temperature continues to rise and reaches the maximum operating limit ( $T_{BUS\_LIM}$ ), no input current is drawn from CHGIN and the battery powers the entire system load.
- 3) Adaptive Battery Charging: While the system is powered from CHGIN, the charger draws power from SYS to charge the battery. If the total load exceeds the input current limit, the battery supplies supplemental current to the load.
- 4) Adaptive Input Current Limiting: If the MAX14748 input current limit is programmed in such a way that the adapter voltage collapses due to resistive drop, current limiting, or poor load transient response, the AICL loop allows the MAX14748 to regulate the input voltage above a value needed to ensure proper operation. [Figure 2](#) illustrates high-level operation of the AICL block and associated parameters are found in the registers 0x2C to 0x2E.

\*JEITA (Japan Electronics and Information Technology Industries Association) Standard, A Guide to the Safe Use of Secondary Lithium Ion Batteries on Notebook-Type Personal Computers, April 20, 2007.

Table 1a. Automatic Input Current Limit Control

ChgTyp[1:0]	PrChgTyp[2:0]	CCiStat[1:0]	SDPMaxCur[1:0]	CDPMaxCur[1:0]	I <sub>LIM</sub>	SpvChgIlim[4:0]
"xx"	"xxx"	"11 = 3A"	"00"	"0"	3A	0x1D
"11 = 1.5A"	"xxx"	"11 = 3A"	"xx"	"x"	3A	0x1D
"xx"	"110 = 3A"	"xx"	"xx"	"x"	3A	0x1D
"xx"	"101 = 2.4A"	"00" or "01 = 500mA" or "10 = 1.5A"	"xx"	"x"	2.4A	0x17
"xx"	"100 = 2A" or "001 = 2A"	"00" or "01 = 500mA" or "10 = 1.5A"	"xx"	"x"	2A	0x13
"1x = 1.5A"	"000" or "010 = 500mA"	"00" or "01 = 500mA" or "10 = 1.5A"	"xx"	"x"	1.5A	0x0E
"1x = 1.5A"	"000" or "010 = 500mA" or "011 = 1A"	"10 = 1.5A"	"xx"	"x"	1.5A	0x0E
"xx"	"011 = 1A"	"00" or "01 = 500mA"	"xx"	"x"	1A	0x09
"01 = 500mA"	"000" or "010 = 500mA"	"00" or "01 = 500mA"	"xx"	"x"	0.5A	0x04
"01 = 500mA"	"000"	"10 = 1.5A" or "11 = 3A"	01	"x"	0.5A	0x04
"01 = 500mA"	"000"	"10 = 1.5A" or "11 = 3A"	10	"X"	1.0A	0x09
"01 = 500mA"	"000"	"10 = 1.5A" or "11 = 3A"	11	"x"	1.5A	0x0E
"10 = 1.5A"	"000"	"11 = 3A"	xx	"1"	1.5A	0x0E
"00"	"xxx"	"xx"	"xx"	"x"	NA	NA

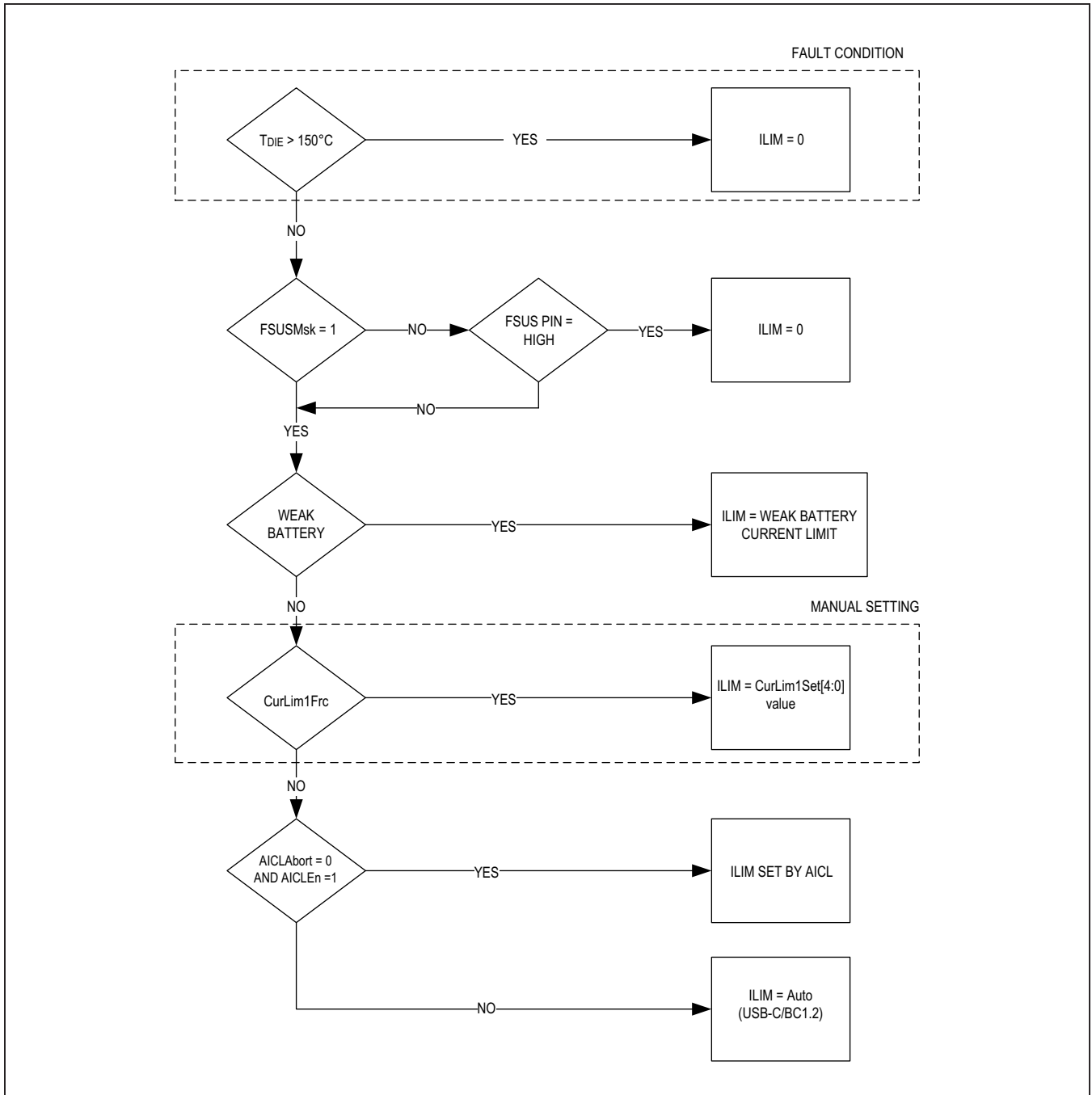

Figure 1. Input Current Limit Settings Flow Diagram

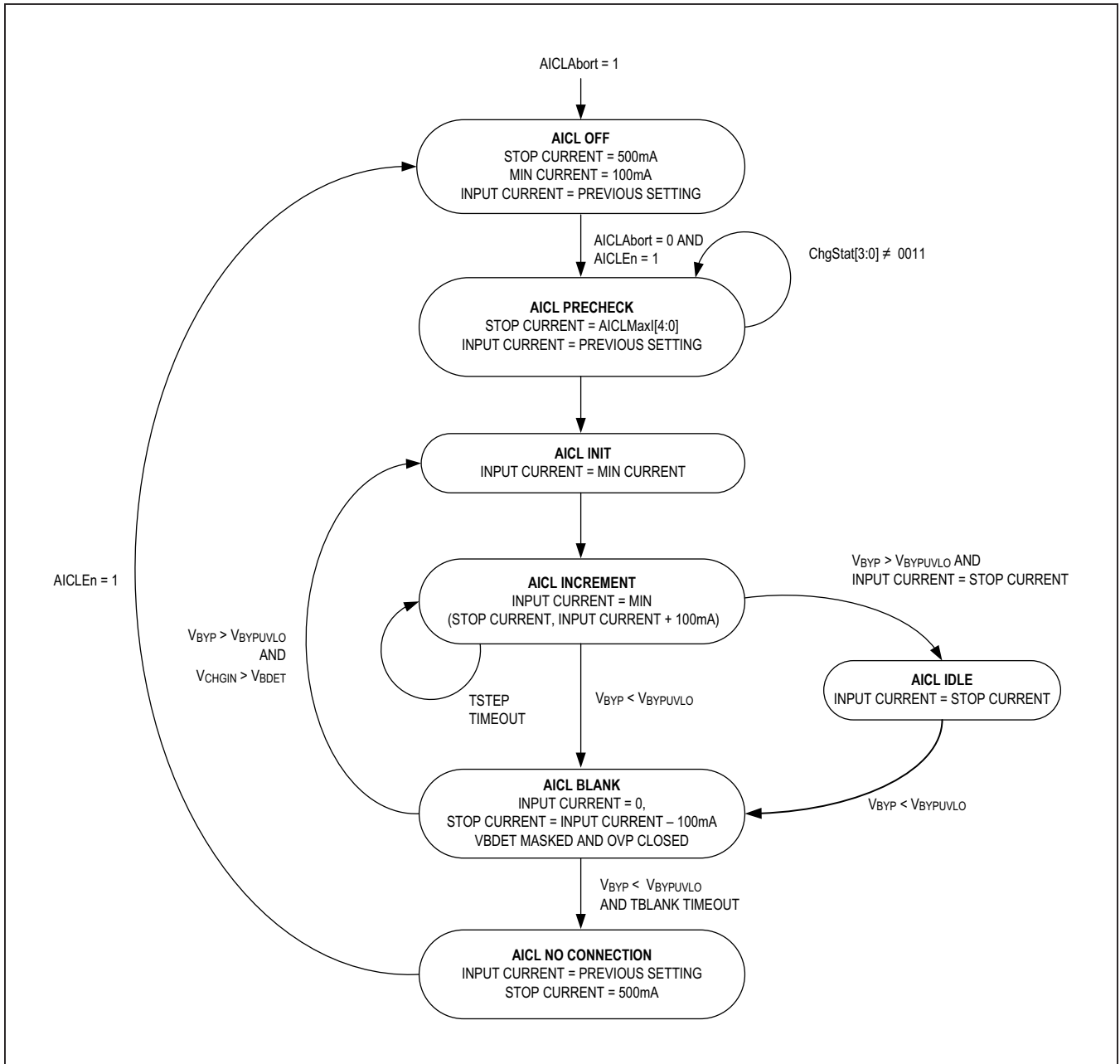

Figure 2. AICL Operation Flow Diagram

## Boost Converter with Reverse Buck

### Boost Mode

The MAX14748 boost converter operates as either a current-limited voltage source, or current source, depending on the charger operational state. When a valid USB voltage is present at CHGIN, and the charger is disabled,  $V_{SYS}$  is regulated to  $V_{BAT} + 400mV$ . If the charger is in precharge mode,  $V_{SYS}$  is regulated to  $V_{PCHG} + 400mV$ . When the system is in fast-charge mode, the boost converter operates as a current source, delivering current into the SYS node that is shared by the battery and system loads.

The boost converter current limit may be acted upon by multiple system blocks, including the programmed input current limit, thermal status, charging current, SYS regulation voltage block, and battery termination voltage block. The minimum requested current from these blocks at any given time determines the active current limit in the boost.

### Reverse Buck Mode

The CHGIN-SYS switching converter may operate as a buck converter when needed to supply a load attached to CHGIN. The load may be a Type-C sink or some other proprietary device.

If Type-C DRP operation is enabled, the buck converter can be enabled by the Type-C state machine. The output voltage of the buck can be programmed from 4V to 5.5V in 0.1V steps by writing to BuckVSet[3:0], however, it is not recommended to change the output voltage when the buck is active.

The output of the buck converter turns off when a fault occurs. The specific fault occurred is indicated by DCDCILim, DCDCRunAway, DCDCPGood status bits (register 0x04). See [I2C Register Descriptions](#) for more details. When the buck is disabled due to a fault, both VBUSDet (register 0x07) and VSAFE0V (register 0x0A) change to 0. After the fault condition is removed, the buck converter can be restarted by writing 1 to CCSnkRst, CCSrcRst, CCForceError, or USBCRset auto-reset bits.

### Smart Power Selector

The Smart Power Selector seamlessly distributes power between CHGIN, battery (BAT) and the system (SYS). The basic modes of operation of the smart power selector are:

1. With a valid external power source:
  - a. The external power source at CHGIN is the primary source of energy.
  - b. The battery is the secondary source of energy.
  - c. Energy delivery to SYS is the highest priority.
  - d. Any energy that is not required by SYS is available to the battery.
2. With no power source available at CHGIN:
  - a. The battery is the primary source of energy.
  - b. Energy delivery to SYS has the highest priority.
3. With a Type-C Sink or other load present at CHGIN:
  - a. The battery is the primary source of energy.
  - b. Energy delivery to SYS is the highest priority.
  - c. Energy delivery to BYP is the second highest priority.

4. SYS Regulation Voltage:
  - a. When the charger path is enabled and the charger is disabled,  $V_{SYS}$  is regulated to  $V_{BAT} + 400mV$  and BAT switch is off.
  - b. When the charger is enabled but in a non-charging state such as maintain charge done, thermistor suspend, or timer fault,  $V_{SYS}$  is regulated to  $V_{BAT} + 400mV$  and BAT switch is off.
  - c. When the input charger path is enabled and the battery is charging in prequalification,  $V_{SYS}$  is regulated to  $V_{PCHG} + 400mV$ . Charge current is reduced when  $V_{SYS}$  approaches  $V_{PCHG} + 200mV$ .
  - d. When the input charger path is enabled and the battery is charging in fast-charge or maintain charge done, the BAT switch is closed and  $V_{SYS} = V_{BAT}$ . In maintain charge done state, the connection between SYS and BAT acts as an ideal diode. Therefore, when  $V_{SYS}$  drops below  $V_{BAT}$ , the BAT switch is turned fully on and the battery supplements the SYS load along with the current from CHGIN.
  - e. When the switching converter is enabled as a reverse buck, the BAT switch is closed and  $V_{SYS} = V_{BAT}$ .

### Short-Circuit Protection

The MAX14748 provides short-circuit protection to the power nodes. When SYS is shorted to ground, input current from CHGIN is limited by boost converter current limit. Note in this case, FET diode from BAT-SYS prevents control of FET BAT-SYS current. Battery current is not limited by the MAX14748 and a pack protector is needed to limit the battery current.

When either BYP or CHGIN is shorted to ground, the current from BAT is limited by the reverse buck converter.

### USB Type-C 1.1

#### USB Type-C 1.1 UFP and DRP Support

The MAX14748 provides support for devices functioning as a Upstream Facing Port (UFP) or Dual Role Port (DRP) per the current USB Type-C 1.1 specification. When acting as a power source in DRP mode, the MAX14748 can provide a 5V  $V_{BUS}$  on the CHGIN pin through operation of the reverse buck converter. The USB Type-C  $V_{CONN}$  supply is provided externally via the  $V_{CONN}$  pin, and switched internally onto one of the CC pins. An open-drain output pin, BVCEN, is provided to enable the external  $V_{CONN}$  supply based on the Type-C state machine output. BVCEN is a push-pull output between GND and  $V_{CCINT}$ .

#### USB BC1.2 Compliant and Nonstandard Charger Support

The BC1.2 charger detection and special charger detection routine is embedded within the Type-C state machine. The BC1.2 and Special Charger detection routine runs always when the state machine enters the 'AttachWait.SNK' state of the USB Type-C 1.1 state-machine.

#### USB Type-C Adapter Insertion

[Figure 3a](#) and [Figure 3b](#) depict the general timings when a USB Type-C adapter is attached. For more information on the behavior and timings of the USB Type-C 1.1 state-machine, please refer to the USB Type-C specification.

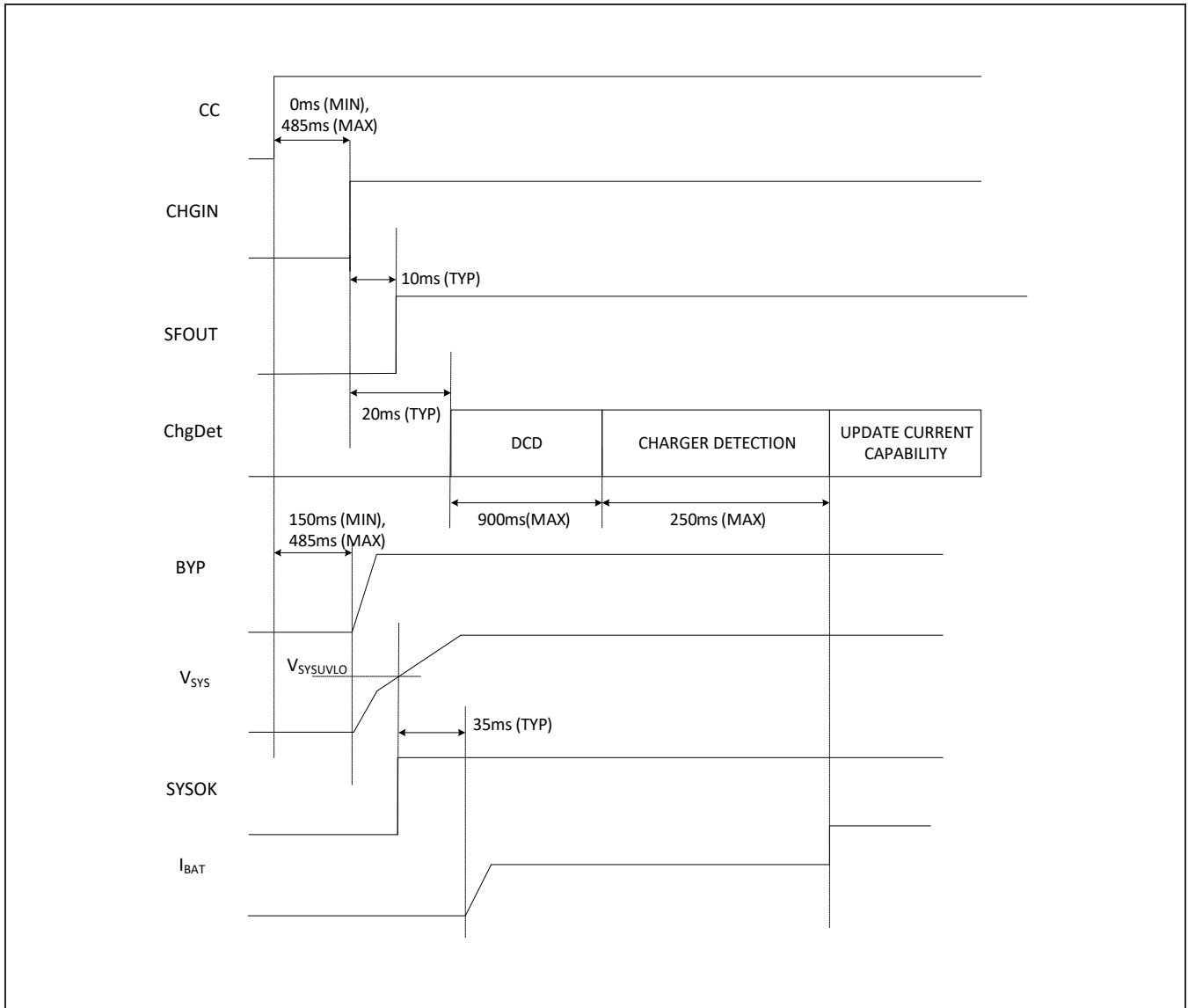

Figure 3a. Type-C Adapter Insertion (CHGINILimGate = 0)

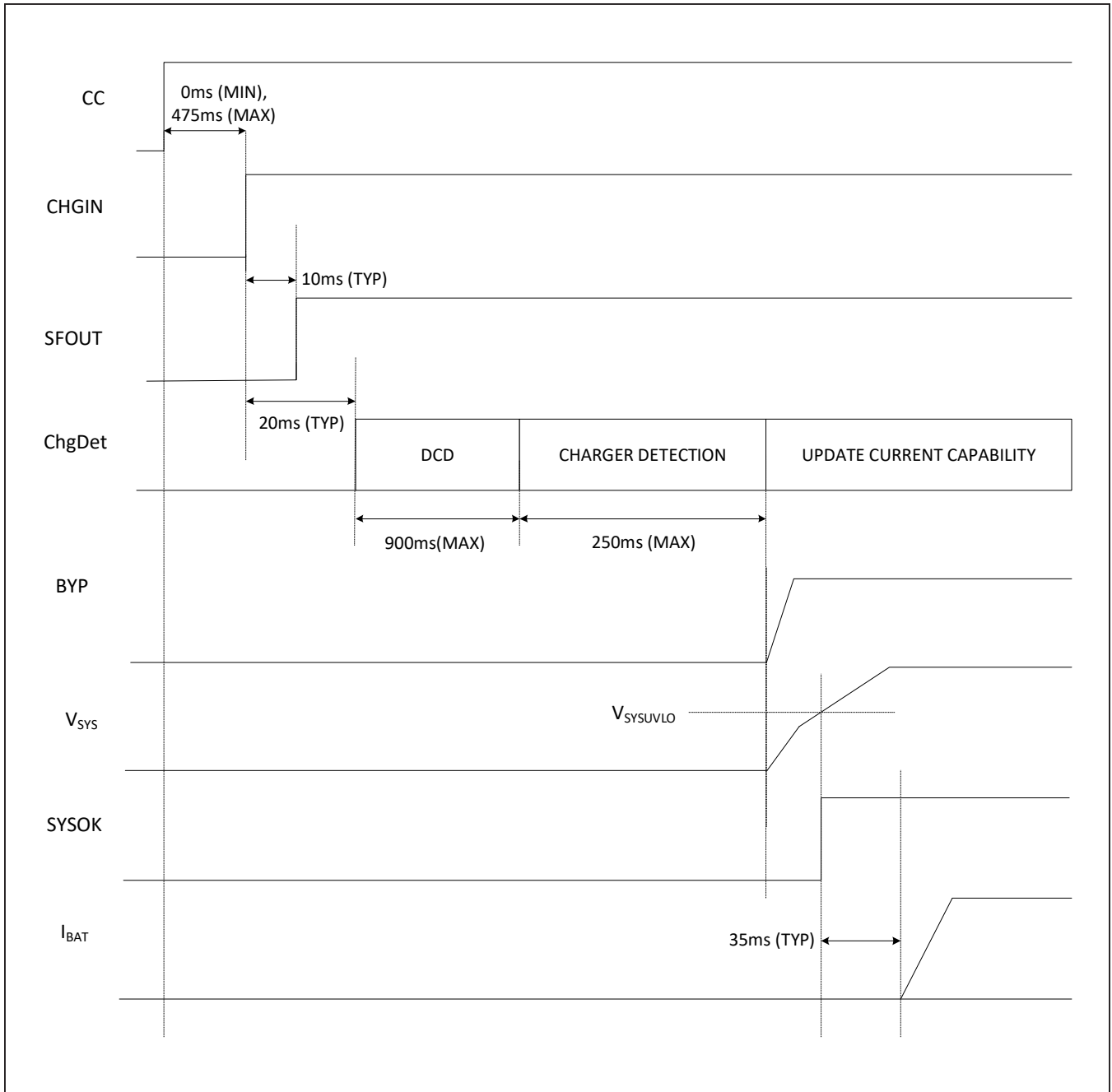

Figure 3b. Type-C Adapter Insertion (CHGINLimGate = 1)



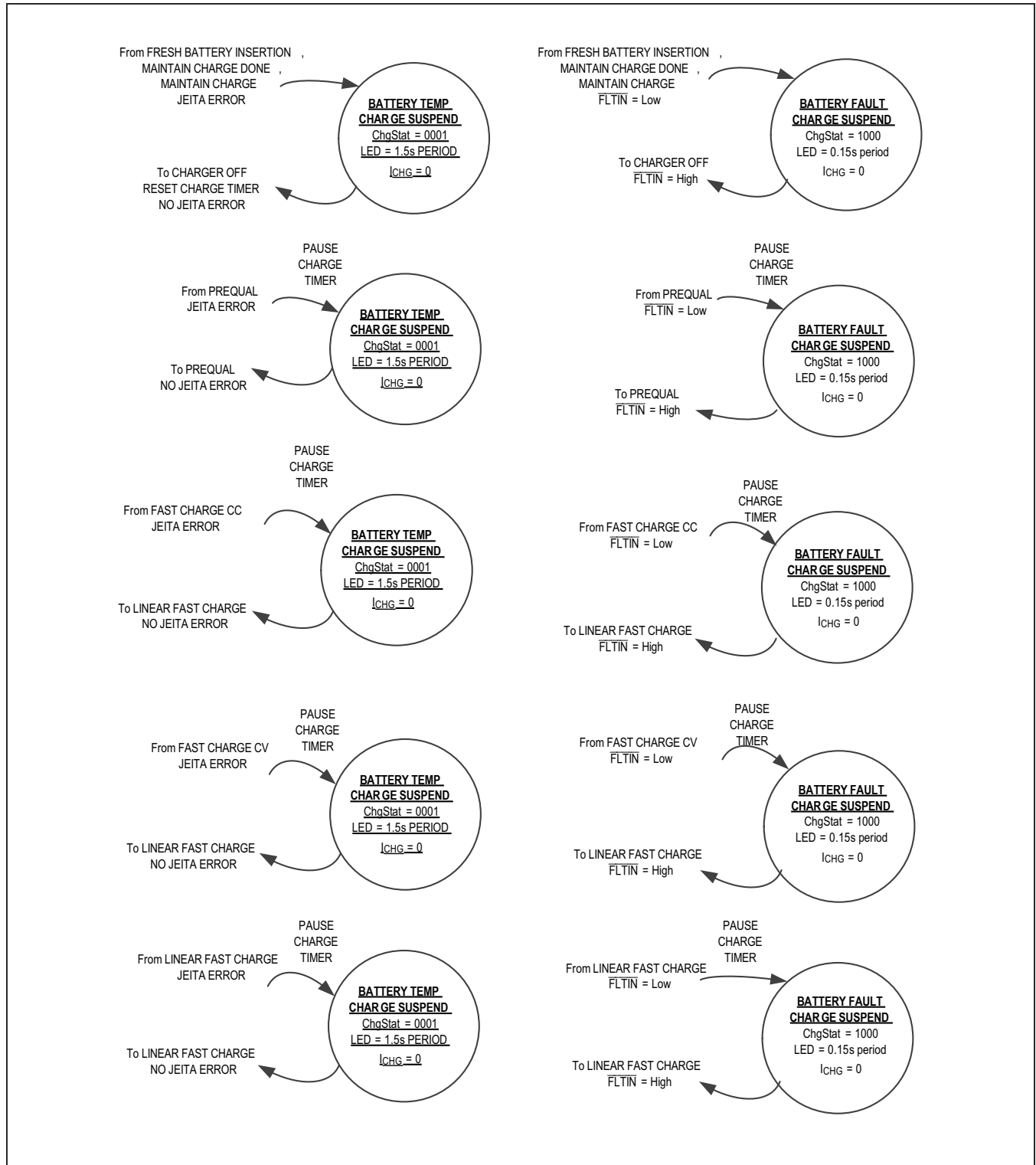

Figure 5. Battery Charger State Diagram (continued)

## Li-ion Battery Charger

### Charger Overview

The MAX14748 utilizes a boost converter to generate the necessary voltage to charge a 2s Li-ion battery from a nominal 5V USB charger input. Depending on the charging phase, the boost converter will operate as either a current-limited voltage source or current source. The charger is configured through a combination of external components and I<sup>2</sup>C registers settings. See [Figure 4](#) and [Figure 5](#) for the *Battery Charger State Diagram*. Note, for MAX14748, do not remove the battery while the charger is enabled (ChgEn=1).

### Precharge

In precharge and charge termination phases, the boost converter functions as a current-limited voltage source and regulates V<sub>SYS</sub> to V<sub>PCHG</sub> +400mV. The battery is charged through an internal linear charging path with a maximum precharge current of 500mA (subject to thermal limitations), programmable through I<sup>2</sup>C. The precharge/fast-charge thresholds can be configured through register 0x1E and may not be less than the V<sub>OVP</sub> (max).

### Fast Charge

In the fast-charge phase, the boost converter functions as a current source delivering current into the SYS node. The SYS and BAT nodes are shorted together through the BAT-SYS FET, with a nominal resistance of 13mΩ (typ). The fast-charge current is set by an external resistor, but may be modified by the T\_T\_IFchg[2:0] bits in registers 0x1A and 0x1B. The fast-charge current resistor can be calculated as  $R_{SET} = K_{SET}/I_{FCHG}$ , where K<sub>SET</sub> has a typical value of 10000A/A. The range of acceptable resistors for R<sub>SET</sub> is 3.3kΩ to 100kΩ.

### Charge Termination

During the charge termination phase, the battery current is monitored across the BAT-SYS FET. To prevent a 'false' termination of charge, the charge done condition is qualified by the state of the input current limit; if the input current limit is currently active, the charge done condition is not triggered. The charge done condition is also debounced for 140μs in order to prevent transient system currents from triggering an incorrect done condition.

### Thermistor Monitoring

The MAX14748 provides highly programmable thermal/ JEITA charge management. All thermal/JEITA charge

configuration parameters are set via the ThermCfg registers 0x1A - 0x1C. The charger is managed by thermal information only if JEITACtrSet = 1.

The battery pack temperature is measured from a divider formed by a pull-up resistor, an optional parallel resistor, and the battery pack thermistor. When required, the pullup resistor is connected to an internal supply through the TPU input, and the voltage on the THM pin is compared to an internal threshold. The supply voltage for the divider is applied to the V<sub>TPU</sub> pin and may be connected to an external supply or to V<sub>CCINT</sub>. The pullup resistor may be complemented with an additional parallel resistor to allow matching to different thermistor nominal values and charging cutoff temperatures, T1, T2, T3, and T4. There are two sets of cutoff temperatures optimized for a thermistor with Beta = 3380 (0°C/10°C/45°C/60°C or 0°C/10°C/25°C/45°C) which can be selected as factory default options. These cutoff temperatures divide the temperature range into three zones, T1\_T2, T2\_T3, and T3\_T4. The charger is always turned off at temperatures outside these zones when any thermal monitoring mode is enabled. If the system needs to measure the THM temperature when not charging, the internal pullup switch may be enabled through the JeitaCfgr[1:0] bits.

Charging may be optionally disabled in the T1\_T2 and T3\_T4 zones through the T\_T\_EnSet bits. The charge current in each zone may be modified through T\_T\_IFchg[2:0]. Battery-voltage termination reduction may also be selectively applied through the T\_T\_VFset bits. See [Figure 6](#) for more details.

### Weak Battery Operation

The MAX14748 supports the weak battery provision of the USB 2.0 specification. If an SDP adapter is detected and the battery voltage is less than the precharge threshold, the input current limit is set to 500mA and a 2-minute timer starts. After the 2-minute timer expires, the input current limit is set to zero. Any time during the 2-minute countdown, the system may turn off the weak battery state machine and assert control of the input current limit by setting WeakBatEn to 0.

### Battery Detection

The MAX14748 offers battery detection by detecting the presence of the battery thermistor. If the thermistor is not present, THM is pulled high by the external pullup resistor, and BatDet is set to 0 indicating that the battery is not connected.

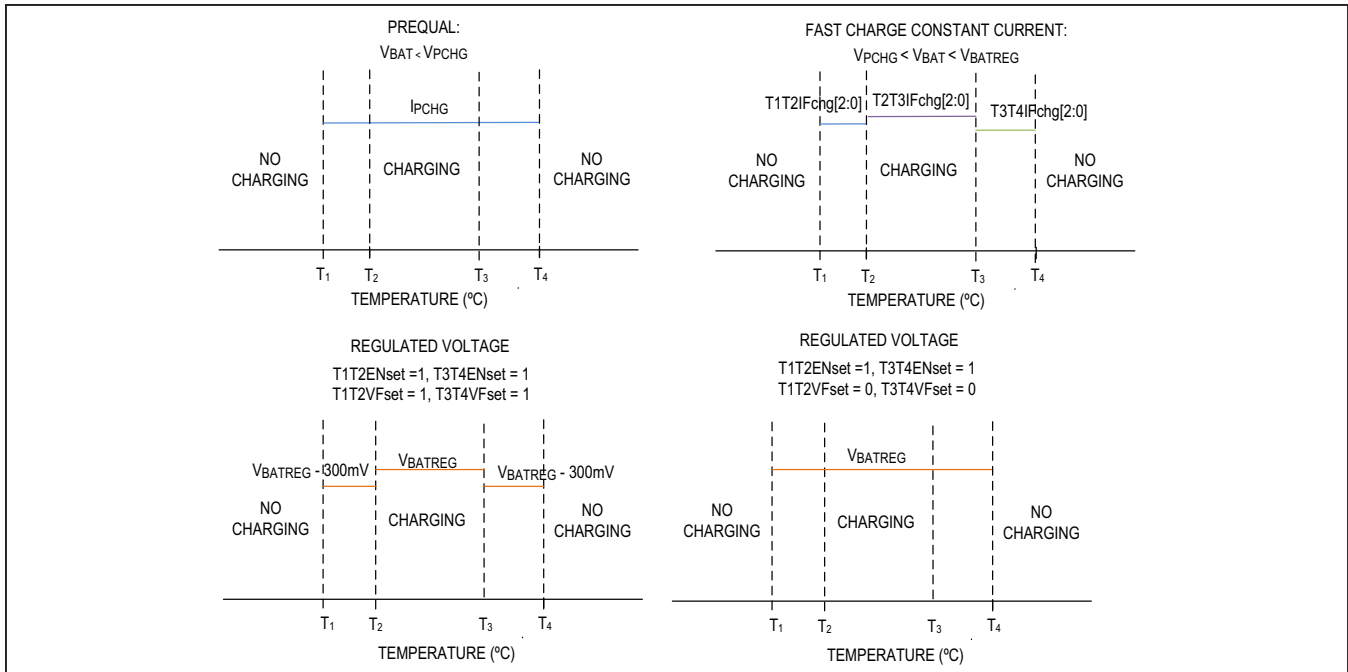

Figure 6. Thermistor Monitoring

### Deeply Discharged Battery

Pack protectors that have a diode in series with the battery cell during recovery can cause the BAT voltage to rise above the precharge threshold of the charger. In the battery recovery state, if  $V_{CELL} + 0.6V > V_{PCHG}$ , the fast-charge state can be entered prematurely, eventually triggering a system fault. To avoid this issue in these pack protectors, ChgEn bit of ChargerCtr1 register (0x1D) can be controlled by the application processor in a manner such that charger does not enter fast charge mode until the battery pack successfully recovers from the deeply discharged state. The recommendation is to set ChgEn to 1 for 60ms to charge the battery in precharge mode followed by resetting ChgEn to 0 for 1ms to prevent the charger from entering fast-charge mode prematurely. This 60ms/1ms combination should be repeated until the battery pack successfully recovers. The total time to a successful recovery can be shortened by using a higher fast-charge current level IFCHG and a higher precharge current setting IPCHG. It is also recommended to use the highest setting for the prequalification threshold VPCHG.

### Integrated USB 2.0 Analog Switch

A high-speed USB switch is integrated to provide the host data access to the connected USB device when an SDP or CDP port is detected. The analog switch may

be controlled manually or automatically by configuring the AnSwCntl[1:0] bits in register 0x2F. When the analog switch control is set to the auto control setting then the CDN/CDP pins are connected to TDN/TDP only when a SDP or CDP port is detected. (See [I2C Register Descriptions](#) for further details.)

### SFOUT LDO

The SFOUT LDO is powered directly from the CHGIN input and may be used to power a USB transceiver, or as an indicator signal that a SDP/CDP port is present. The LDO will operate with CHGIN voltages greater than  $V_{BDET}$ . The output voltage of SFOUT is selectable as either 5V or 3.3V through the SfOutLvl bit, depending on the system preference. SFOUT may be programmed to turn on automatically when an SDP or CDP is detected, or placed in manual mode and turned on through an I2C command. This supply is always available when CHGIN is present.

### Internal Supplies and Regulators

The MAX14748 has two internal power supplies: VCCINT and BREG. VCCINT and BREG are always present when CHGIN or BAT is present. These supplies share a common source, but bypassed separately. The VCCINT and BREG supplies require external bypass capacitors and are regulated to a nominal value of 4.3V (typ).

## Device Control Interface

While the MAX14748 is primarily controlled by I<sup>2</sup>C, GPIO control is also offered for specific functions. The following GPIO control signals are provided (note that these signals only apply when CHGIN is present):

- 1) **FSUS (Input):** Force Suspend. This pin enables the host microcontroller to force the input current limit to zero. When CHGIN is present, a logic-high on the pin causes the input OVP FET at CHGIN to open and the input current to MAX14748 is reduced to less than 2mA. This pin has no effect if FSUSMsk = 1.
- 2) **FLTIN (Input):** Battery Fault Input. This pin allows the system or battery pack to place the charger into a fault condition using a GPIO pin. See Register 0x35 description for more details.
- 3) **CDIR (Open-Drain Output):** USB Superspeed MUX control. In USB Type-C plug configurations, it is necessary to detect the orientation of the connector and route the Superspeed lines accordingly. The pin can be used to automatically configure a USB Superspeed MUX according to the orientation information contained in the integrated Type-C detection block. (This information is also available through I<sup>2</sup>C) The

CDIR output is pulled to GND when the CC1 pin is active on the Type-C connector, otherwise it is high-impedance.

- 4) **SYOK (Open-Drain Output):** With CHGIN present, the SYOK output is asserted if the boost regulator generates a  $V_{SYS}$  greater than SYS UVLO threshold,  $V_{SYSUVLO}$ . Otherwise, the output is high-impedance. This pin can be used as wake up the host system from a dead-battery. Note that when  $V_{SYS}$  falls below the SYS UVLO falling threshold, the input OVP switch is opened as the boost converter cannot operate in this state.
- 5) **BVCEN (Open-Drain Output):** When CHGIN is present and a Type-C device that requires  $V_{CONN}$  is found, this pin is asserted. This pin should be connected to the enable pin of the  $V_{CONN}$  power supply enable. The output of BVCEN is push-pull between GND and  $V_{CCINT}$ .

## System Faults

The MAX14748 monitors the system for faults including OVP Soft Start Timeout, SYS UVLO, Direct Charging Fault, Charger Timeout, Forced Charger Fault, Dead Battery, CHGIN OVP. See [Table 1b](#) for more details.

**Table 1b. System Faults Summary**

FAULT NAME	EFFECT	CAUSE DESCRIPTION	HOW TO RECOVER	STAUS BIT
OVP Soft-Start TimeOut	System Fault Condition Latched. OVP/Boost/Charger Off	UFP: $V_{BYP}$ is not within 50mV of $V_{CHGIN}$ at Soft Start TimeOut (100ms typ)	Unplug/Replug Type-C cable or reset device via USBCRSet of Reg 0x30	SysFlt (Reg 0x02)
SYS UVLO	System Fault Condition Latched. OVP/Boost/Charger Off	UFP: $V_{SYS}$ falls below SYS UVLO threshold while in Boost mode or $V_{SYS}$ fails to reach above SYS UVLO threshold within 20ms after $V_{BYP}$ rises	Unplug/Replug Type-C cable or reset device via USBCRSet of Reg 0x30	SysFlt (Reg 0x02)
Direct Charging Fault	Charger Fault Condition Latched. Charger Off	UFP: $V_{BAT}$ falls below $V_{PCHG}$ while in Fast Charge mode	Cycle ChgEn or treat as System Fault	DirChgFault (Reg 0x05)
Charger Timeout	Charger Fault Condition Latched. Charger Off	UFP: Pre-charge or Fast-charge Timer expires	Cycle ChgEn or treat as System Fault	ChgStat[3:0] (Reg 0x05)
Forced Charger Fault	Charger Off	UFP: Logic-low applied on $\overline{FLTIN}$ pin	Logic-high applied on $\overline{FLTIN}$ pin	ChgStat[3:0] (Reg 0x05)
Dead Battery	System Fault Condition Latched. OVP/Boost/Charger Off	UFP: DeadBattery detection enabled and SDP detected: $V_{BAT}$ fails to reach above $V_{PCHG}$ within 2min	Treat as System Fault or disable DeadBattery	WbChg (Reg 0x02)
CHGIN OVP	OVP/Boost/Charger OFF	$V_{CHGIN}$ rises above $V_{OVP}$	Reduce $V_{CHGIN}$ below $V_{OVP\_F}$	ChginOVP (Reg 0x02)

### I<sup>2</sup>C Interface

The MAX14748 contains an I<sup>2</sup>C-compatible interface for data communication with a host controller (SCL and SDA). The interface supports a clock frequency of up to 400kHz. SCL and SDA require pullup resistors that are connected to a positive supply.

### Start, Stop, And Repeated Start Conditions

When writing to the MAX14748 using I<sup>2</sup>C, the master sends a START condition (S) followed by the MAX14748 I<sup>2</sup>C address. After the address, the master sends the register address of the register that is to be programmed. The master then ends communication by issuing a STOP condition (P) to relinquish control of the bus, or a REPEATED START condition (Sr) to communicate to another I<sup>2</sup>C slave. See [Figure 7](#).

**Table 2. I<sup>2</sup>C Slave Addresses**

ADDRESS FORMAT	HEX	BINARY
7-Bit Slave ID	0x0A	0001010
Write Address	0x14	00010100
Read Address	0x15	00010101

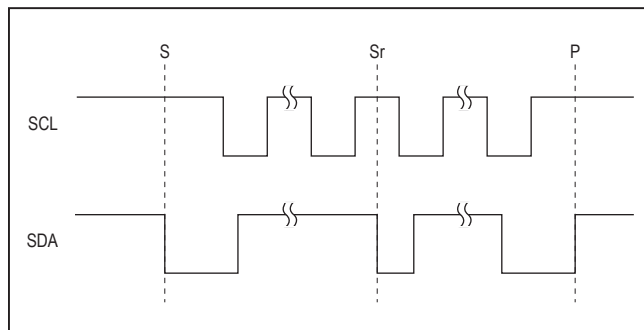

Figure 7. I<sup>2</sup>C START, STOP and REPEATED START Conditions

### Slave Address

Set the Read/Write bit high to configure the MAX14748 to read mode ([Table 2](#)). Set the Read/Write bit low to configure the MAX14748 to write mode. The address is the first byte of information sent to the MAX14748 after the START condition.

### Bit Transfer

One data bit is transferred on the rising edge of each SCL clock cycle. The data on SDA must remain stable during the high period of the SCL clock pulse. Changes in SDA while SCL is high and stable are considered control signals (see the [Start, Stop, And Repeated Start Conditions](#) section). Both SDA and SCL remain high when the bus is not active.

### Single-Byte Write

In this operation, the master sends an address and two data bytes to the slave device ([Figure 8](#)). The following procedure describes the single byte write operation:

- 1) The master sends a START condition
- 2) The master sends the 7-bit slave address plus a write bit (low)
- 3) The addressed slave asserts an ACK on the data line
- 4) The master sends the 8-bit register address
- 5) The slave asserts an ACK on the data line only if the address is valid (NAK if not)
- 6) The master sends 8 data bits
- 7) The slave asserts an ACK on the data line
- 8) The master generates a STOP condition

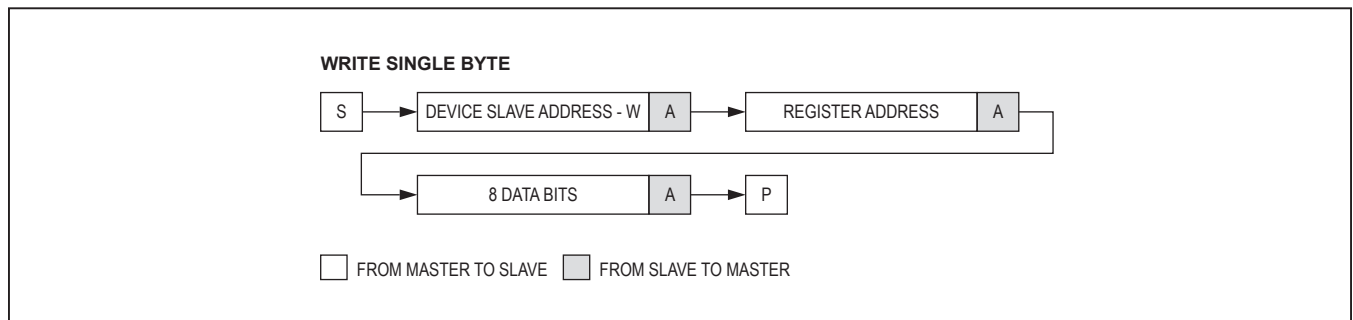

Figure 8. Write Byte Sequence

**Burst Write**

In this operation, the master sends an address and multiple data bytes to the slave device (Figure 9). The slave device automatically increments the register address after each data byte is sent. The following procedure describes the burst write operation:

- 1) The master sends a START condition.
- 2) The master sends the 7-bit slave address plus a write bit (low).
- 3) The addressed slave asserts an ACK on the data line.
- 4) The master sends the 8-bit register address.
- 5) The slave asserts an ACK on the data line only if the address is valid (NAK if not).
- 6) The master sends eight data bits.
- 7) The slave asserts an ACK on the data line.
- 8) Repeat 6 and 7 N-1 times.
- 9) The master generates a STOP condition.

**Single-Byte Read**

In this operation, the master sends an address plus two data bytes and receives one data byte from the slave device (Figure 10). The following procedure describes the single byte read operation:

- 1) The master sends a START condition.
- 2) The master sends the 7-bit slave address plus a write bit (low).
- 3) The addressed slave asserts an ACK on the data line.
- 4) The master sends the 8-bit register address.
- 5) The slave asserts an ACK on the data line only if the address is valid (NAK if not).
- 6) The master sends a REPEATED START condition.
- 7) The master sends the 7-bit slave address plus a read bit (high).
- 8) The addressed slave asserts an ACK on the data line.
- 9) The slave sends eight data bits.
- 10) The master asserts a NACK on the data line.
- 11) The master generates a STOP condition.

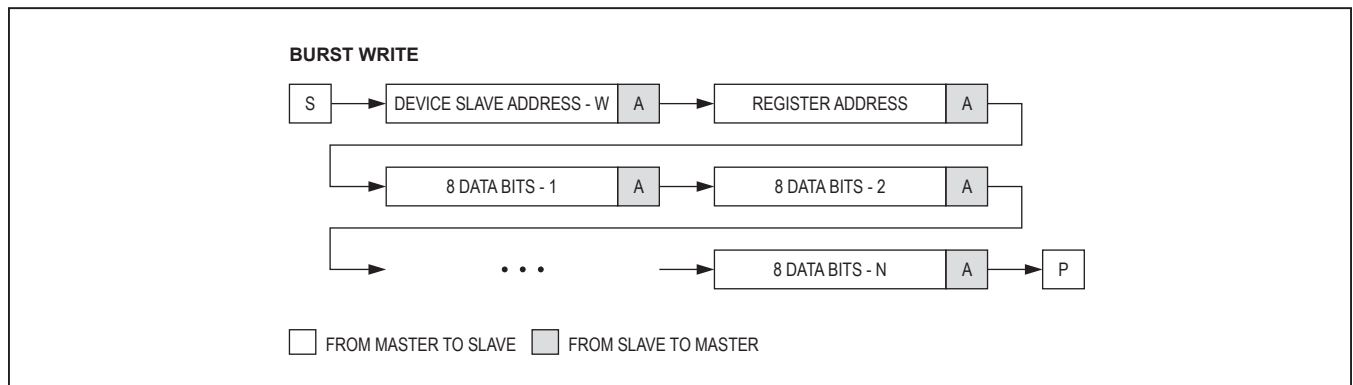

Figure 9. Burst Write Sequence

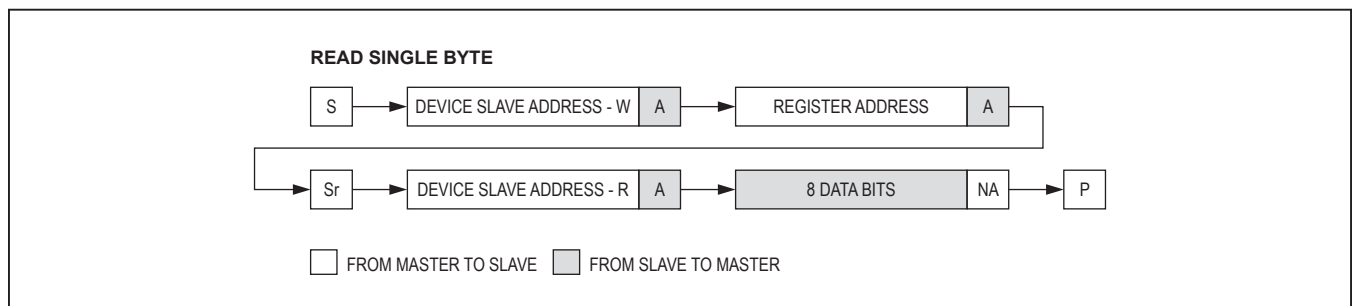

Figure 10. Read Byte Sequence

**Burst Read**

In this operation, the master sends an address plus two data bytes and receives multiple data bytes from the slave device (Figure 11). The following procedure describes the burst byte read operation:

- 1) The master sends a START condition.
- 2) The master sends the 7-bit slave address plus a write bit (low).
- 3) The addressed slave asserts an ACK on the data line.
- 4) The master sends the 8-bit register address.
- 5) The slave asserts an ACK on the data line only if the address is valid (NAK if not).
- 6) The master sends a REPEATED START condition.
- 7) The master sends the 7-bit slave address plus a read bit (high).
- 8) The slave asserts an ACK on the data line.

- 9) The slave sends eight data bits.
- 10) The master asserts an ACK on the data line.
- 11) Repeat 9 and 10 N-2 times.
- 12) The slave sends the last eight data bits.
- 13) The master asserts a NACK on the data line.
- 14) The master generates a STOP condition.

**Acknowledge Bits**

Data transfers are acknowledged with an acknowledge bit (ACK) or a not-acknowledge bit (NACK). Both the master and the MAX14748 generate ACK bits. To generate an ACK, pull SDA low before the rising edge of the ninth clock pulse and hold it low during the high period of the ninth clock pulse (see Figure 12). To generate a NACK, leave SDA high before the rising edge of the ninth clock pulse and leave it high for the duration of the ninth clock pulse. Monitoring for NACK bits allows for detection of unsuccessful data transfers.

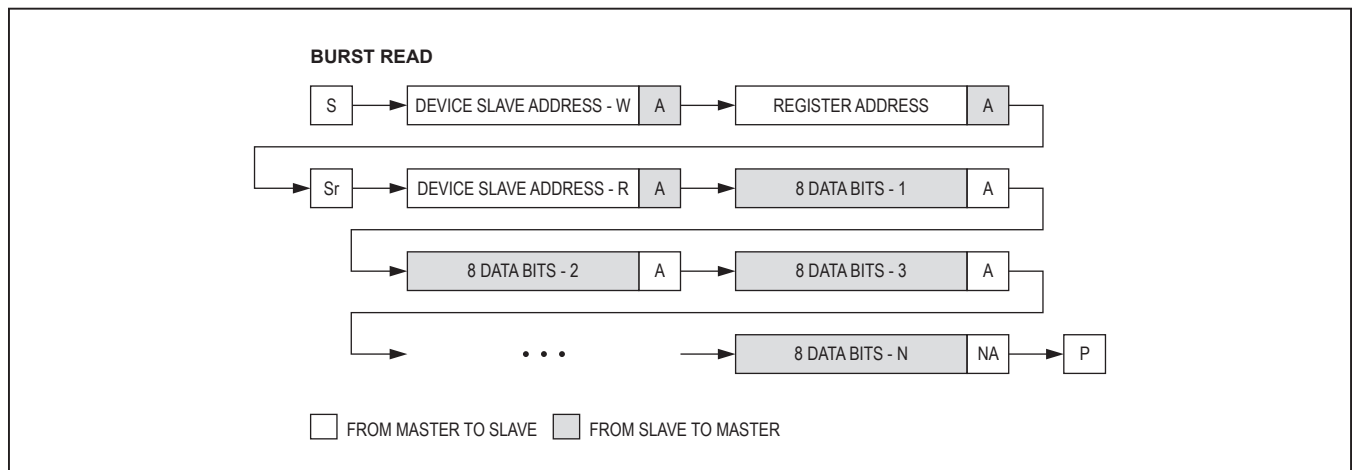

Figure 11. Burst Read Sequence

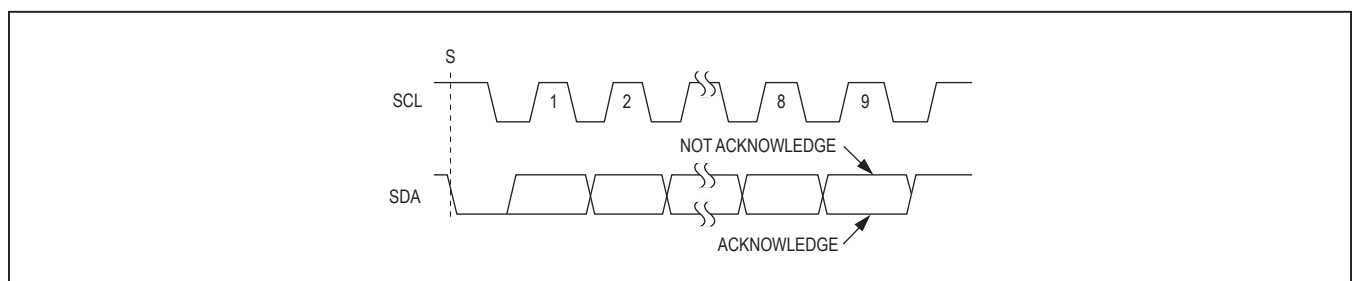

Figure 12. Acknowledge

Table 3. I<sup>2</sup>C Register Map

REGISTER ADDRESS	REGISTER NAME	R/W	B7	B6	B5	B4	B3	B2	B1	B0
0x00	ChipID	R	ChipID[7:0]							
0x01	ChipRev	R	ChipRevH[3:0]							
0x02	DevStatus1	R	SysFlt	ChgInOVP	ILim	VSysReg	ThrmSd150	ThrmSd120	BatDet	WbChg
0x03	AICLStatus	R	AICLStatus[2:0]							
0x04	DevStatus2	R	-	BattPREQB	-	BypUVLO	SysUVLOB	DCDCILim	DCDCRunAway	DCDCPGood
0x05	ChgStatus	R	DirChgFault	-	LowPow	-	-	ChgStat[3:0]		
0x06	JEITAStatus	R	-	-	-	ChgThrmRegCur	ChgThrmRegVlt	ChgThrmStat[2:0]		
0x07	BCStatus	R	VBUSDet	ChgTypRun	-	PrChgTyp[2:0]	-	DCDTrmo	ChgTyp[1:0]	-
0x08	Reserved	R	-	-	-	-	-	-	-	-
0x09	CCStatus1	R	CCPinStat[1:0]							
0x0A	CCStatus2	R	-	-	-	-	CCVcnStat	CCStat[2:0]	-	-
0x0B	DevInt1	COR	SysFlt	ChgInOVPI	ILim	VSysReg	ThrmSd150I	ThrmSd120I	BatDetI	WbChgI
0x0C	AICLInt	COR	-	AICLI	-	-	-	-	-	-
0x0D	DevInt2	COR	-	BattPREQi	-	BypUVLOI	SysUVLOI	-	-	DCDCPGoodI
0x0E	ChgInt	COR	DirChgFaultI	LowPowRI	LowPowFI	-	-	-	-	ChgStatI
0x0F	JEITAIInt	COR	-	-	-	ChgThrmRegCurl	ChgThrmRegVHi	-	-	ChgThrmStatI
0x10	BCInt	COR	VBUSDetI	-	-	ChgTypRunFI	ChgTypRunRI	PrChgTypI	DCDTmol	ChgTypI
0x11	CCInt	COR	-	VSAFE0VI	DetAbrtI	-	CCPinStatI	CCStatI	CCVcnStatI	CCStatI
0x12	DevInt1Mask	R/W	SysFltIM	ChgInOVPIIM	ILimIM	VSysRegIM	ThrmSd150IM	ThrmSd120IM	BatDetIM	WbChgIM
0x13	AICLIntMask	R/W	-	AICLIM	-	-	-	-	-	-
0x14	DevInt2Mask	R/W	-	BattPREQIM	-	BypUVLOIM	SysUVLOIM	DCDCILimIM	DCDCRunAwayIM	DCDCPGoodIM
0x15	ChgIntMask	R/W	DirChgFaultIM	LowPowRIM	LowPowFIM	-	-	-	-	ChgStatIM
0x16	JEITAIIntMask	R/W	-	-	-	ChgThrmRegCurlIM	ChgThrmRegVHiIM	-	-	ChgThrmStatIM
0x17	BCIntMask	R/W	VBUSDetIM	-	-	ChgTypRunFIM	ChgTypRunRIM	PrChgTypIM	DCDTmolIM	ChgTypIM
0x18	CCIntMask	R/W	-	VSAFE0VIM	DetAbrtIM	-	CCPinStatIM	CCStatIM	CCVcnStatIM	CCStatIM
0x19	LED_CTRL	R/W	-	-	-	-	-	LEDCtrl	LEDManual	-
0x1A	ThermaCfg1	R/W	T1T2IFchg[2:0]							
0x1B	ThermaCfg2	R/W	T3T4IFchg[2:0]							
0x1C	ThermaCfg3	R/W	-	-	-	-	T3T4ENset	T1T2ENset	T3T4VFset	T1T2VFset
0x1D	ChargerCtrl1	R/W**	ChgAutoStp	BatReChg[1:0]	FreshBatDis (MAX14748B)	-	-	BatReg[1:0]	ChgEn	-
0x1E	ChargerCtrl2	R/W**	-	VPchg[2:0]	IPChg[1:0]	-	-	ChgDone[1:0]	-	-

**Table 3. I<sup>2</sup>C Register Map (continued)**

REGISTER ADDRESS	REGISTER NAME	R/W	B7	B6	B5	B4	B3	B2	B1	B0
0x1F	ChargerCtrl3	R/W**	-	ChgAutoSta	MtChgTmr[1:0]	-	FChgTmr[1:0]	WeakBatEn	PCChgTmr[1:0]	-
0x20	ChargerCtrl4	R/W**	-	WeakBatStat[2:0]*	-	-	-	WeakBatEn	-	-
0x21	CurLimCtrl	R/W	CurLim1Frc	FSUSMsk	-	-	-	CurLim1Set[4:0]	-	-
0x22	CurLimStatus	R	-	CurLim2Rb[2:0]	-	-	-	SpvChgLim[4:0]	-	-
0x23	BBCFG1	R/W**	-	BoostRComp[3:0]			-	-	-	-
0x24	BBCFG2	R/W**	-	-	-	BBFrcZX	-	BuckVSet[3:0]	-	-
0x25	BCCtrl1	R/W	DChg2s	SFOutLvl	-	ADC3PDet	SFOutCtrl[1:0]	ChgDetMan	ChgDetEn	-
0x26	Reserved	R	-	-	-	-	-	-	-	-
0x27	CCCtrl1	R/W	-	-	-	CCSrcSnk	CCSrcSnk	CCDbgEn	CCAudEn	CCDetEn
0x28	CCCtrl2	R/W	CCForceError	SnkAttached Lock	CCSrcSnkSwp	CCSrcSnkSwp	CCVcnSwp	CCVcnEn	CCSrcRst	CCSnkRst
0x29	CCCtrl3	R/W	-	-	-	-	CCTrySnk	CCPreferSnk	CCDRPPPhase[1]	CCDRPPPhase[0]
0x2A	CHGINLim1	R	-	-	-	-	CHGINLim[6:0]			-
0x2B	CHGINLim2	R/W	-	-	-	-	CHGINLimGate	SDPMaxCur[1:0]	CDPMaxCur	-
0x2C	AICLCFG1	R/W	AICLEn	-	-	-	-	-	-	AICLAbort
0x2D	AICLCFG2	R/W	BYPUVLO[2:0]			-	-	AICLMax[4:0]		
0x2E	AICLCFG3	R/W	-	-	-	BYPDeb	AICLTBlk[1:0]	-	AICLTStep[1:0]	-
0x2F	DPDNSw	R/W	-	-	-	-	-	-	AnSwCtrl[1:0]	-
0x30	Others	R/W	-	-	-	-	-	-	-	USBCRset
0x31	Reserved	R	-	-	-	-	-	-	-	-
0x32	Reserved	R	-	-	-	-	-	-	-	-
0x33	LowPow	R/W	LowPowEn	-	-	-	-	-	-	LowPowAbort
0x34	Reserved	R	-	-	-	-	-	-	-	-
0x35	FLTSEL	R/W	FLTSelect[1:0]			-	-	-	-	-

**Note :** COR = Clear-on-read

\* Read Only

\*\* Read Only if WriteProtect is enabled (See Table 61).

- Reserved bits must not be modified from their default states to ensure proper operation.

## I<sup>2</sup>C Register Descriptions

### Table 4. ChipID Register (0x00)

<b>ADDRESS:</b>	0x00							
<b>MODE:</b>	Read Only							
<b>BIT</b>	7	6	5	4	3	2	1	0
<b>NAME</b>	ChipId[7:0]							
<b>ChipId[7:0]</b>	ChipId[7:0] bits show information about the version of the MAX14748.							

### Table 5. ChipRev Register (0x01)

<b>ADDRESS:</b>	0x01							
<b>MODE:</b>	Read Only							
<b>BIT</b>	7	6	5	4	3	2	1	0
<b>NAME</b>	ChipRevH[3:0]				ChipRevL[3:0]			
<b>ChipRevH[3:0]</b>	ChipRevH[3:0] bits show information about the revision of the MAX14748 silicon.							
<b>ChipRevL[3:0]</b>	ChipRevL[3:0] bits show information about the revision of the MAX14748 silicon.							

### Table 6. DevStatus1 Register (0x02)

<b>ADDRESS:</b>	0x02							
<b>MODE:</b>	Read Only							
<b>BIT</b>	7	6	5	4	3	2	1	0
<b>NAME</b>	SysFit	ChgInOVP	ILim	VSysReg	ThrmSd150	ThrmSd120	BatDet	WbChg
<b>SysFit</b>	System Fault 0 = System voltage is normal 1 = SYS voltage below SYS UVLO Threshold and the condition latched.							
<b>ChgInOVP</b>	CHGIN Overvoltage Protection Flag 0 = CHGIN OVP not active 1 = CHGIN OVP active							
<b>ILim</b>	Input Current Limiting 0 = CHGIN input current within limit 1 = CHGIN input in current limit							
<b>VSysReg</b>	SYS Regulation (SYSOK) 0 = SYS voltage above SYS UVLO threshold and boost regulating SYS 1 = SYS voltage below SYS UVLO threshold or Boost not regulating SYS							
<b>ThrmSd150</b>	Thermal shutdown 0 = Device in normal operation Mode 1 = Device in thermal shutdown ( $T_{DIE} > 150^{\circ}\text{C}$ )							
<b>ThrmSd120</b>	Thermal Warm 0 = Device in normal operation Mode 1 = $120^{\circ}\text{C} < T_{DIE} < 150^{\circ}\text{C}$							
<b>BatDet</b>	Status of Battery Detection 0 = No battery detected 1 = Battery detected							
<b>WbChg</b>	Weak Battery Charging 0 = Weak Battery Charge Timer expired or not running 1 = Weak Battery Charge Timer running							

**Table 7. AICLStatus Register (0x03)**

<b>ADDRESS:</b>	<b>0x03</b>							
<b>MODE:</b>	<b>Read Only</b>							
<b>BIT</b>	<b>7</b>	<b>6</b>	<b>5</b>	<b>4</b>	<b>3</b>	<b>2</b>	<b>1</b>	<b>0</b>
<b>NAME</b>	AICLStatus[2:0]				AICLCurSet[4:0]			
<b>AICLStatus[2:0]</b>	AICL Status 000 = AICL Off 001 = AICL Precheck 010 = AICL Increment 011 = AICL Blank 100 = AICL Idle 101 = AICL No Connection							
<b>AICLCurSet[4:0]</b>	Current limit set by AICL (if active) 0 = 100mA 1 = 200mA ... 30 = 3.1A 31 = 3.2A							

**Table 8. DevStatus2 Register (0x04)**

<b>ADDRESS:</b>	<b>0x04</b>							
<b>MODE:</b>	<b>Read Only</b>							
<b>BIT</b>	<b>7</b>	<b>6</b>	<b>5</b>	<b>4</b>	<b>3</b>	<b>2</b>	<b>1</b>	<b>0</b>
<b>NAME</b>	–	BattPREQB	–	BypUVLO	SysUVLOB	DCDCILim	DCDCRunAway	DCDCPGood
<b>BattPREQB</b>	$V_{BAT}$ vs. $V_{PCHG}$ ( $V_{PCHG}$ programmable from 5.7V to 6.4V, BattPreqB status is NOT valid while the Weak Battery 2min timer is running.) 0 = $V_{BAT}$ below $V_{PCHG}$ threshold 1 = $V_{BAT}$ above $V_{PCHG}$ threshold							
<b>BypUVLO</b>	$V_{BYP}$ vs. $V_{BYPUVLO}$ ( $V_{BYPUVLO}$ programmable from 3.8V to 4.5V) 0 = $V_{BYP}$ above $V_{BYPUVLO}$ threshold 1 = $V_{BYP}$ below $V_{BYPUVLO}$ threshold							
<b>SysUVLOB</b>	$V_{SYS}$ vs. $V_{SYSUVLO}$ ( $V_{SYSUVLO}$ programmable from 6.1V to 6.8V, SysUVLOB status is only valid in boost mode with CHGIN present) 0 = $V_{SYS}$ below $V_{SYSUVLO}$ threshold 1 = $V_{SYS}$ above $V_{SYSUVLO}$ threshold							
<b>DCDCILim</b>	Reverse Buck Converter Current Limit Status 0 = Normal Operation 1 = Buck current limit has been reached							
<b>DCDCRunAway</b>	Reverse Buck Converter Runaway Status 0 = Normal Operation 1 = Buck runaway is asserted							
<b>DCDCPGood</b>	Reverse Buck Converter Regulation Status 0 = Buck regulated value below 82% of the target value 1 = Normal operation							

**Table 9. ChgStatus Register (0x05)**

ADDRESS:	0x05							
MODE:	Read Only							
BIT	7	6	5	4	3	2	1	0
NAME	DirChgFault	-	LowPow	-	ChgStat[3:0]			
<b>DirChgFault</b>	Direct charging fault 0 = Device in normal operation 1 = V <sub>BAT</sub> drops below V <sub>PCHG</sub> when battery is in supplement mode.							
<b>LowPow</b>	Low Power Mode 0 = Not In Low Power Mode 1 = In Low Power Mode							
<b>ChgStat[3:0]</b>	Status of Charger Mode 0000 = Charger off 0001 = Charging suspended due to temperature (see state diagram) 0010 = Pre-charge in progress 0011 = Fast-charge, constant current mode in progress 0100 = Fast-charge, constant voltage mode in progress 0101 = Maintain charge in progress 0110 = Maintain charge done 0111 = Charger fault condition (see state diagram) 1000 = Battery Fault Suspend (see state diagram)							

**Table 10. JEITAStatus Register (0x06)**

ADDRESS:	0x06							
MODE:	Read Only							
BIT	7	6	5	4	3	2	1	0
NAME	-	-	-	ChgThrmRegCur	ChgThrmRegVlt	ChgThrmStat[2:0]		
<b>ChgThrmRegCur</b>	FastCharge Current reduced due to JEITA status 0 = Not changed 1 = Reduced							
<b>ChgThrmRegVlt</b>	Battery Regulation Voltage reduced due to JEITA status 0 = Not Changed 1 = Reduced							
<b>ChgThrmStat[2:0]</b>	Thermistor Monitor 000 = T < T <sub>1</sub> 001 = T <sub>1</sub> < T < T <sub>2</sub> 010 = T <sub>2</sub> < T < T <sub>3</sub> 011 = T <sub>3</sub> < T < T <sub>4</sub> 100 = T > T <sub>4</sub> 101 = No thermistor detected (THM high due to external pullup). Note: If a parallel resistor is used for thermistor monitoring, this mode may not function properly. 110 = NTC input disabled through ThermEn. 111 = Detection disabled due to CHGIN not present.							

**Table 11. BCStatus Register (0x07)**

<b>ADDRESS:</b>	<b>0x09</b>							
<b>MODE:</b>	<b>Read Only</b>							
<b>BIT</b>	<b>7</b>	<b>6</b>	<b>5</b>	<b>4</b>	<b>3</b>	<b>2</b>	<b>1</b>	<b>0</b>
<b>NAME</b>	VBUSDet	ChgTypRun	PrChgTyp[2:0]			DCDTmo	ChgTyp[1:0]	
<b>VBUSDet</b>	Status of CHGIN Detection 0 = VCHGIN < VBDET 1 = VCHGIN > VBDET							
<b>ChgTypRun</b>	Charger Detection Running Status 0 = Not Running 1 = Running							
<b>PrChgTyp[2:0]</b>	Output of Proprietary Charger Detection 000 = Unknown 001 = Samsung 2A 010 = Apple 0.5A 011 = Apple 1A 100 = Apple 2A 101 = Apple 12W 110 = 3A DCP (If enabled) 111 = RFU							
<b>DCDTmo</b>	DCD Time Out. DCD detection timed out during charger detection, indicating D+/D- are open. BC1.2 detection continues as required by BC1.2, but SDP most likely is found. 0 = No Timeout or detection not run 1 = DCD Timeout occurred							
<b>ChgTyp[1:0]</b>	Output of Charger Detection 00 = Nothing attached 01 = SDP, USB Cable attached 10 = CDP, Charging Downstream Port (current depends on USB operating speed) 11 = DCP, Dedicated Charger (current up to 1.5A)							

**Table 12. Reserved Register (0x08)**

<b>ADDRESS:</b>	<b>0x08</b>							
<b>MODE:</b>	<b>Read Only</b>							
<b>BIT</b>	<b>7</b>	<b>6</b>	<b>5</b>	<b>4</b>	<b>3</b>	<b>2</b>	<b>1</b>	<b>0</b>
<b>NAME</b>	-	-	-	-	-	-	-	-

**Table 13. CCStatus1 Register (0x09)**

ADDRESS:	0x09							
MODE:	Read Only							
BIT	7	6	5	4	3	2	1	0
NAME	CCPinStat[1:0]		CCISat		CCVcnStat	CCStat[2:0]		
<b>CCPinStat[1:0]</b>	Status of Active CC Pin 00 = No Determination 01 = CC1 Active 10 = CC2 Active 11 = RFU							
<b>CCISat</b>	CC Pin Detected Allowed VBUS Current in UFP mode 00 = Not in UFP mode 01 = 500mA 10 = 1.5A 11 = 3.0A							
<b>CCVcnStat</b>	Status of VCONN Output 0 = VCONN Disabled 1 = VCONN Enabled							
<b>CCStat[2:0]</b>	Output of CC Pin Detection State Machine 000 = No Connection 001 = UFP 010 = DFP 011 = Audio Accessory 100 = Debug Accessory 101 = Error 110 = Disabled 111 = RFU							

**Table 14. CCStatus2 Register (0x0A)**

ADDRESS:	0x0A							
MODE:	Read Only							
BIT	7	6	5	4	3	2	1	0
NAME	-	-	-	-	VSAFE0V	DetAbrt	-	-
<b>VSAFE0V</b>	Status of VBUS Detection. (Valid only in Attached.SRC_CCx, Attached.SNK_CCx state) 0 = $V_{CHGIN} < V_{SAFE0V}$ 1 = $V_{CHGIN} > V_{SAFE0V}$							
<b>DetAbrt</b>	Charger Detection Abort 0 = Charger Detection runs if ChgDetEn = 1 and VBUS is valid for the debounce time 1 = Charger Detection is aborted by Type-C State Machine. Charger detection will run if ChgDetEn = 1 and VBUS is valid for the debounce time. ChgDetMan bit allows manual run of charger detection. If Charger Detection is in progress, DetAbrt = 1 immediately stops the in-progress detection.							

**Table 15. DevInt1 Register (0x0B)**

ADDRESS:	0x0B							
MODE:	Clear On Read							
BIT	7	6	5	4	3	2	1	0
NAME	SysFitI	ChgInOVPI	ILimI	VSysRegI	ThrmSd150I	ThrmSd120I	BatDetI	WbChgI
<b>SysFitI</b>	SysFit status change interrupt. 0 = Status of SysFit has NOT changed since the last time SysFitI was read 1 = Status of SysFit has changed since the last time SysFitI was read							
<b>ChgInOVPI</b>	ChgInOVP status change interrupt. 0 = Status of ChgInOVP has NOT changed since the last time ChgInOVPI was read 1 = Status of ChgInOVP has changed since the last time ChgInOVPI was read							
<b>ILimI</b>	ILim status change interrupt. 0 = Status of ILim has NOT changed since the last time ILimI was read 1 = Status of ILim has changed since the last time ILimI was read							
<b>VSysRegI</b>	VSysReg status change interrupt. 0 = Status of VSysReg has NOT changed since the last time VSysRegI was read 1 = Status of VSysReg has changed since the last time VSysRegI was read							
<b>ThrmSd150I</b>	ThrmSd150 status change interrupt. 0 = Status of ThrmSd150 has NOT changed since the last time ThrmSd150I was read 1 = Status of ThrmSd150 has changed since the last time ThrmSd150I was read							
<b>ThrmSd120I</b>	ThrmSd120 status change interrupt. 0 = Status of ThrmSd120 has NOT changed since the last time ThrmSd120I was read 1 = Status of ThrmSd120 has changed since the last time ThrmSd120I was read							
<b>BatDetI</b>	BatDet status change interrupt. 0 = Status of BatDet has NOT changed since the last time BatDetI was read 1 = Status of BatDet has changed since the last time BatDetI was read							
<b>WbChgI</b>	WbChg status change interrupt. 0 = Status of WbChg has NOT changed since the last time WbChgI was read 1 = Status of WbChg has changed since the last time WbChgI was read							

**Table 16. AICLIInt Register (0x0C)**

ADDRESS:	0x0C							
MODE:	Clear On Read							
BIT	7	6	5	4	3	2	1	0
NAME	-	AICLI	-	-	-	-	-	-
<b>AICLI</b>	AICLIStatus status change interrupt. 0 = Status of AICLIStatus has NOT changed since the last time AICLI was read 1 = Status of AICLIStatus has changed since the last time AICLI was read							

Table 17. DevInt2 Register (0x0D)

ADDRESS:	0x0D							
MODE:	Clear On Read							
BIT	7	6	5	4	3	2	1	0
NAME	-	BattPREQI	-	BypUVLOI	SysUVLOI	DCDCILimI	DCDCRunAwayI	DCDCPGoodI
<b>BattPREQI</b>	BattPREQ status change interrupt. 0 = Status of BattPREQ has NOT changed since the last time BattPREQI was read 1 = Status of BattPREQ has changed since the last time BattPREQI was read							
<b>BypUVLOI</b>	BypUVLO status change interrupt. 0 = Status of BypUVLO has NOT changed since the last time BypUVLOI was read 1 = Status of BypUVLO has changed since the last time BypUVLOI was read							
<b>SysUVLOI</b>	SysUVLO status change interrupt. 0 = Status of SysUVLO has NOT changed since the last time SysUVLOI was read 1 = Status of SysUVLO has changed since the last time SysUVLOI was read							
<b>DCDCILimI</b>	DCDCILim status change interrupt. 0 = Status of DCDCILim has NOT changed since the last time DCDCILim was read 1 = Status of DCDCILim has changed since the last time DCDCILim was read							
<b>DCDCRunAwayI</b>	DCDCRunAway status change interrupt. 0 = Status of DCDCRunAway has NOT changed since the last time DCDCRunAway was read 1 = Status of DCDCRunAway has changed since the last time DCDCRunAway was read							
<b>DCDCPGoodI</b>	DCDCPGood status change interrupt. 0 = Status of DCDCPGood has NOT changed since the last time DCDCPGoodI was read 1 = Status of DCDCPGood has changed since the last time DCDCPGoodI was read							

Table 18. ChgInt Register (0x0E)

ADDRESS:	0x0E							
MODE:	Clear On Read							
BIT	7	6	5	4	3	2	1	0
NAME	DirChgFaultI	LowPowRI	LowPowFI	-	-	-	-	ChgStatI
<b>DirChgFaultI</b>	DirChgFault status change interrupt. 0 = Status of DirChgFault has NOT changed since the last time DirChgFaultI was read 1 = Status of DirChgFault has changed since the last time DirChgFaultI was read							
<b>LowPowRI</b>	LowPow Rising Edge interrupt. 0 = LowPow bit rise edge has NOT occurred since the last time LowPowRI was read 1 = LowPow bit rise edge has occurred since the last time LowPowRI was read							
<b>LowPowFI</b>	LowPow Falling Edge interrupt. 0 = LowPow bit falling edge has NOT occurred since the last time LowPowFI was read 1 = LowPow bit falling edge has occurred since the last time LowPowFI was read							
<b>ChgStatI</b>	ChgStat[3:0] status change interrupt. 0 = Status of ChgStat[3:0] has NOT changed since the last time ChgStatI was read 1 = Status of ChgStat[3:0] has changed since the last time ChgStatI was read							

**Table 19. JEITAInt Register (0x0F)**

ADDRESS:	0x0F							
MODE:	Clear On Read							
BIT	7	6	5	4	3	2	1	0
NAME	-	-	-	ChgThrmRegCurl	ChgThrmRegVItl	-	-	ChgThrmI
<b>ChgThrmRegCurl</b>	ChgThrmRegCur status change interrupt. 0 = Status of ChgThrmRegCur has NOT changed since the last time ChgThrmRegCurl was read 1 = Status of ChgThrmRegCur has changed since the last time ChgThrmRegCurl was read							
<b>ChgThrmRegVItl</b>	ChgThrmRegVIt status change interrupt. 0 = Status of ChgThrmRegVIt has NOT changed since the last time ChgThrmRegVItl was read 1 = Status of ChgThrmRegVIt has changed since the last time ChgThrmRegVItl was read							
<b>ChgThrmStatI</b>	ChgThrmStat[2:0] status change interrupt. 0 = Status of ChgThrmStat[2:0] has NOT changed since the last time ChgThrmStatI was read 1 = Status of ChgThrmStat[2:0] has changed since the last time ChgThrmStatI was read							

**Table 20. BCInt Register (0x10)**

ADDRESS:	0x10							
MODE:	Clear On Read							
BIT	7	6	5	4	3	2	1	0
NAME	VBUSDetI	-	-	ChgTypRunFI	ChgTypRunRI	PrChgTypI	DCDTmol	ChgTypI
<b>VBUSDetI</b>	VBUSDet status change interrupt. 0 = Status of VBUSDet has NOT changed since the last time VBUSDetI was read 1 = Status of VBUSDet has changed since the last time VBUSDetI was read							
<b>ChgTypRunFI</b>	ChgTypRun Falling Edge interrupt. 0 = ChgTypRun bit falling edge has NOT occurred since the last time ChgTypRunFI was read 1 = ChgTypRun bit falling edge has occurred since the last time ChgTypRunFI was read							
<b>ChgTypRunRI</b>	ChgTypRun Rising Edge interrupt. 0 = ChgTypRun bit rising edge has NOT occurred since the last time ChgTypRunRI was read 1 = ChgTypRun bit rising edge has occurred since the last time ChgTypRunRI was read							
<b>PrChgTypI</b>	PrChgTyp status change interrupt. 0 = Status of PrChgTyp has NOT changed since the last time PrChgTypI was read 1 = Status of PrChgTyp has changed since the last time PrChgTypI was read							
<b>DCDTmol</b>	DCDTmo status change interrupt. 0 = Status of DCDTmo has NOT changed since the last time DCDTmol was read 1 = Status of DCDTmo has changed since the last time DCDTmol was read							
<b>ChgTypI</b>	ChgTyp status change interrupt. 0 = Status of ChgTyp has NOT changed since the last time ChgTypI was read 1 = Status of ChgTyp has changed since the last time ChgTypI was read							

**Table 21. CCInt Register (0x11)**

<b>ADDRESS:</b>	0x11							
<b>MODE:</b>	Clear On Read							
<b>BIT</b>	<b>7</b>	<b>6</b>	<b>5</b>	<b>4</b>	<b>3</b>	<b>2</b>	<b>1</b>	<b>0</b>
<b>NAME</b>	-	VSAFE0VI	DetAbtrl	-	CCPinStatl	CCISatl	CCVcnStatl	CCStatl
<b>VSAFE0VI</b>	VSAFE0V status change interrupt. 0 = Status of VSAFE0V has NOT changed since the last time VSAFE0VI was read 1 = Status of VSAFE0V has changed since the last time VSAFE0VI was read							
<b>DetAbtrl</b>	DetAbtrl status change interrupt. 0 = Status of DetAbtrl has NOT changed since the last time DetAbtrl was read 1 = Status of DetAbtrl has changed since the last time DetAbtrl was read							
<b>CCPinStatl</b>	CCPinStat status change interrupt. 0 = Status of CCPinStat has NOT changed since the last time CCPinStatl was read 1 = Status of CCPinStat has changed since the last time CCPinStatl was read							
<b>CCISatl</b>	CCISatl status change interrupt. 0 = Status of CCISatl has NOT changed since the last time CCISatl was read 1 = Status of CCISatl has changed since the last time CCISatl was read							
<b>CCVcnStatl</b>	CCVcnStat status change interrupt. 0 = Status of CCVcnStat has NOT changed since the last time CCVcnStatl was read 1 = Status of CCVcnStat has changed since the last time CCVcnStatl was read							
<b>CCStatl</b>	CCStat status change interrupt. 0 = Status of CCStat has NOT changed since the last time CCStatl was read 1 = Status of CCStat has changed since the last time CCStatl was read							

**Table 22. DevInt1Mask Register (0x12)**

<b>ADDRESS:</b>	<b>0x12</b>							
<b>MODE:</b>	<b>Read/Write</b>							
<b>BIT</b>	<b>7</b>	<b>6</b>	<b>5</b>	<b>4</b>	<b>3</b>	<b>2</b>	<b>1</b>	<b>0</b>
<b>NAME</b>	SysFItIM	ChgInOVPI	ILimIM	VSysRegIM	ThrmSd150IM	ThrmSd120IM	BatDetIM	WbChgIM
<b>SysFItIM</b>	SysFItI Interrupt Mask 1 = Mask 0 = Unmask							
<b>ChgInOVPI</b>	ChgInOVPI Interrupt Mask 1 = Mask 0 = Unmask							
<b>ILimIM</b>	ILimI Interrupt Mask 1 = Mask 0 = Unmask							
<b>VSysRegIM</b>	VSysRegI Interrupt Mask 1 = Mask 0 = Unmask							
<b>ThrmSd150IM</b>	ThrmSd150I Interrupt Mask 1 = Mask 0 = Unmask							
<b>ThrmSd120IM</b>	ThrmSd120I Interrupt Mask 1 = Mask 0 = Unmask							
<b>BatDetIM</b>	BatDetI Interrupt Mask 1 = Mask 0 = Unmask							
<b>WbChgIM</b>	WbChgI Interrupt Mask 1 = Mask 0 = Unmask							

**Table 23. AICLIIntMask Register (0x13)**

<b>ADDRESS:</b>	<b>0x13</b>							
<b>MODE:</b>	<b>Read/Write</b>							
<b>BIT</b>	<b>7</b>	<b>6</b>	<b>5</b>	<b>4</b>	<b>3</b>	<b>2</b>	<b>1</b>	<b>0</b>
<b>NAME</b>	-	AICLIM	-	-	-	-	-	-
<b>AICLIM</b>	AICLI Interrupt Mask 1 = Mask 0 = Unmask							

**Table 24. DevInt2Mask Register (0x14)**

<b>ADDRESS:</b>	<b>0x14</b>							
<b>MODE:</b>	<b>Read/Write</b>							
<b>BIT</b>	<b>7</b>	<b>6</b>	<b>5</b>	<b>4</b>	<b>3</b>	<b>2</b>	<b>1</b>	<b>0</b>
<b>NAME</b>	-	BattPREQIM	-	BypUVLOIM	SysUVLOIM	DCDCILimIM	DCDCRunAwayIM	DCDCPGoodIM
<b>BattPREQIM</b>	BattPREQI Interrupt Mask 1 = Mask 0 = Unmask							
<b>BypUVLOIM</b>	BypUVLOI Interrupt Mask 1 = Mask 0 = Unmask							
<b>SysUVLOIM</b>	SysUVLOI Interrupt Mask 1 = Mask 0 = Unmask							
<b>DCDCILimIM</b>	DCDCILimI Interrupt Mask 1 = Mask 0 = Unmask							
<b>DCDCRunAwayIM</b>	DCDCRunAwayI Interrupt Mask 1 = Mask 0 = Unmask							
<b>DCDCPGoodIM</b>	DCDCPGoodI Interrupt Mask 1 = Mask 0 = Unmask							

**Table 25. ChgIntMask Register (0x15)**

<b>ADDRESS:</b>	<b>0x15</b>							
<b>MODE:</b>	<b>Read/Write</b>							
<b>BIT</b>	<b>7</b>	<b>6</b>	<b>5</b>	<b>4</b>	<b>3</b>	<b>2</b>	<b>1</b>	<b>0</b>
<b>NAME</b>	DirChgFaultIM	LowPowRIM	LowPowFIM	-	-	-	-	ChgStatIM
<b>DirChgFaultIM</b>	DirChgFaultI Interrupt Mask 1 = Mask 0 = Unmask							
<b>LowPowRIM</b>	LowPowRI Interrupt Mask 1 = Mask 0 = Unmask							
<b>LowPowFIM</b>	LowPowFI Interrupt Mask 1 = Mask 0 = Unmask							
<b>ChgStatIM</b>	ChgStatI Interrupt Mask 1 = Mask 0 = Unmask							

**Table 26. JEITAIntMask Register (0x16)**

ADDRESS:	0x16							
MODE:	Read/Write							
BIT	7	6	5	4	3	2	1	0
NAME	-	-	-	ChgThrmRegCurlM	ChgThrmRegVltIM	-	-	ChgThrmStatIM
<b>ChgThrmRegCurlM</b>	ChgThrmRegCurl Interrupt Mask 1 = Mask 0 = Unmask							
<b>ChgThrmRegVltIM</b>	ChgThrmRegVI Interrupt Mask 1 = Mask 0 = Unmask							
<b>ChgThrmIM</b>	ChgThrmI Interrupt Mask 1 = Mask 0 = Unmask							

**Table 27. BCIntMask Register (0x17)**

ADDRESS:	0x17							
MODE:	Read/Write							
BIT	7	6	5	4	3	2	1	0
NAME	VBUSDetIM	-	-	ChgTypRunFIM	ChgTypRunRIM	PrChgTypIM	DCDTmoIM	ChgTypIM
<b>VBUSDetIM</b>	VBUSDetI Interrupt Mask 1 = Mask 0 = Unmask							
<b>ChgTypRunFIM</b>	ChgTypRunFI Interrupt Mask 1 = Mask 0 = Unmask							
<b>ChgTypRunRIM</b>	ChgTypRunRI Interrupt Mask 1 = Mask 0 = Unmask							
<b>PrChgTypIM</b>	PrChgTypI Interrupt Mask 1 = Mask 0 = Unmask							
<b>DCDTmoIM</b>	DCDTmI Interrupt Mask 1 = Mask 0 = Unmask							
<b>ChgTypIM</b>	ChgTypI Interrupt Mask 1 = Mask 0 = Unmask							

**Table 28. CCIntMask Register (0x18)**

<b>ADDRESS:</b>	<b>0x18</b>							
<b>MODE:</b>	<b>Read/Write</b>							
<b>BIT</b>	<b>7</b>	<b>6</b>	<b>5</b>	<b>4</b>	<b>3</b>	<b>2</b>	<b>1</b>	<b>0</b>
<b>NAME</b>	-	VSAFE0VIM	DetAbtrlM	-	CCPinStatIM	CCISatIM	CCVcnStatIM	CCStatIM
<b>VSAFE0VIM</b>	VSAFE0VI Interrupt Mask 1 = Mask 0 = Unmask							
<b>DetAbtrlM</b>	DetAbtrl Interrupt Mask 1 = Mask 0 = Unmask							
<b>CCPinStatIM</b>	CCPinStatI Interrupt Mask 1 = Mask 0 = Unmask							
<b>CCISatIM</b>	CCISatI Interrupt Mask 1 = Mask 0 = Unmask							
<b>CCVcnStatIM</b>	CCVcnStatI Interrupt Mask 1 = Mask 0 = Unmask							
<b>CCStatIM</b>	CCStatI Interrupt Mask 1 = Mask 0 = Unmask							

**Table 29. LED\_CTRL Register (0x19)**

<b>ADDRESS:</b>	<b>0x19</b>							
<b>MODE:</b>	<b>Read/Write</b>							
<b>BIT</b>	<b>7</b>	<b>6</b>	<b>5</b>	<b>4</b>	<b>3</b>	<b>2</b>	<b>1</b>	<b>0</b>
<b>NAME</b>	-	-	-	-	-	-	LEDCtrl	LEDManual
<b>LEDCtrl</b>	LED Manual Control 0 = LED is OFF 1 = LED is ON							
<b>LEDManual</b>	LED Auto/Manual Configuration 0 = LED is controlled via charger state machine. 1 = LED output is manually controlled by LEDCntrl bit.							

**Table 30. ThermaCfg1 Register (0x1A)**

<b>ADDRESS:</b>	0x1A							
<b>MODE:</b>	Read/Write							
<b>BIT</b>	<b>7</b>	<b>6</b>	<b>5</b>	<b>4</b>	<b>3</b>	<b>2</b>	<b>1</b>	<b>0</b>
<b>NAME</b>	T1T2IFchg[2:0]			T2T3IFchg[2:0]			JeitaCfgR[1:0]	
<b>T1T2IFchg[2:0]</b>	Fast Charge Current for T1-T2 temperature zone 000 = 0.2 x IFChg 001 = 0.3 x IFChg 010 = 0.4 x IFChg 011 = 0.5 x IFChg 100 = 0.6 x IFChg 101 = 0.7 x IFChg 110 = 0.8 x IFChg 111 = 1.0 x IFChg							
<b>T2T3IFchg[2:0]</b>	Fast Charge Current for T2-T3 temperature zone 000 = 0.2 x IFChg 001 = 0.3 x IFChg 010 = 0.4 x IFChg 011 = 0.5 x IFChg 100 = 0.6 x IFChg 101 = 0.7 x IFChg 110 = 0.8 x IFChg 111 = 1.0 x IFChg							
<b>JeitaCfgR[1:0]</b>	TPU SW Configuration 00 = JEITA Monitoring and TPU SW disabled 01 = JEITA Monitoring and TPU SW Enabled if $V_{CHGIN} > V_{BDET}$ (10ms Debounce) 10 = JEITA Monitoring and TPU SW Enabled 11 = JEITA Monitoring disabled and TPU SW enabled							

**Table 31. ThermaCfg2 Register (0x1B)**

<b>ADDRESS:</b>	0x1B							
<b>MODE:</b>	Read/Write							
<b>BIT</b>	7	6	5	4	3	2	1	0
<b>NAME</b>	T3T4IFchg[2:0]			-	T3T4ENset	T1T2ENset	T3T4VFset	T1T2VFset
<b>T3T4IFchg[2:0]</b>	Fast Charge Current for T3-T4 temperature zone 000 = 0.2 x IFChg 001 = 0.3 x IFChg 010 = 0.4 x IFChg 011 = 0.5 x IFChg 100 = 0.6 x IFChg 101 = 0.7 x IFChg 110 = 0.8 x IFChg 111 = 1.0 x IFChg							
<b>T3T4ENset</b>	JEITA charger On/Off in T3-T4 zone. (Only valid if JEITACtrSet = 1) 0 = JEITA turns charger off in T3-T4 zone 1 = JEITA doesn't turn charger off in T3-T4 zone							
<b>T1T2ENset</b>	JEITA charger On/Off in T1-T2 zone. (Only valid if JEITACtrSet = 1) 0 = JEITA turns charger off in T1-T2 zone 1 = JEITA doesn't turn charger off in T1-T2 zone							
<b>T3T4VFset</b>	JEITA voltage scaling enable in T3-T4. (Only valid if JEITACtrSet = 1) 1 = Enabled 0 = Disabled							
<b>T1T2VFset</b>	JEITA voltage scaling enabled in T1-T2. (Only valid if JEITACtrSet = 1) 1 = Enabled 0 = Disabled							

**Table 32. ThermaCfg3 Register (0x1C)**

<b>ADDRESS:</b>	0x1C							
<b>MODE:</b>	Read/Write Unless Otherwise Noted							
<b>BIT</b>	7	6	5	4	3	2	1	0
<b>NAME</b>	-	-	-	-	-	-	JEITACtrSet	WarmCoolSel
<b>JEITACtrSet</b>	JEITA Control Enable 0 = JEITA status Not affect charger 1 = JEITA status affects charger settings (See register ThermaCfg2)							
<b>WarmCoolSel</b>	Warm/Cool JEITA Zone Thresholds Select (Read Only). 0 = 45°C Warm, 10°C Cool 1 = 25°C Warm, 10°C Cool							

**Table 33. ChargerCtrl1 Register (0x1D)**

ADDRESS:	0x1D							
MODE:	Read/Write or Read-Only if AppWrtPrct = "(1) Protected" (See Table 61)							
BIT	7	6	5	4	3	2	1	0
NAME	ChgAutoStp	BatReChg[1:0]		FreshBatDis (MAX14748B)	–	BatReg[1:0]		ChgEn
<b>ChgAutoStp</b>	Charger Auto-Stop. Controls the transition from maintain charge to maintain charge done. See <i>Battery Charger State</i> diagram. 0 = Auto-Stop disabled. 1 = Auto-Stop enabled.							
<b>BatReChg[1:0]</b>	BAT Recharge Threshold. If ChgAutoSta = 1, charger restarts charging if $V_{BAT}$ falls below $V_{BATREG}$ by this amount. 00 = 200mV 01 = 300mV 10 = 400mV 11 = 500mV							
<b>FreshBatDis (MAX14748B)</b>	Enable/Disable Fresh Battery Feature (See Fig 4) 0 = Fresh Battery Feature Enabled 1 = Fresh Battery Feature Disabled Note, this bit should only be changed when ChgEn=0.							
<b>BatReg[1:0]</b>	Battery Regulation Threshold 00 = 8.3V 01 = 8.4V 10 = 8.5V 11 = 8.6V							
<b>ChgEn</b>	On/Off Control for Charger (does not impact SYS node). 0 = Charger disabled 1 = Charger enabled							

**Table 34. ChargerCtrl2 Register (0x1E)**

ADDRESS:	0x1E							
MODE:	Read/Write or Read-Only if AppWrtPrct = "(1) Protected" (See Table 61)							
BIT	7	6	5	4	3	2	1	0
NAME	-	VPchg[2:0]			IPChg[1:0]		ChgDone[1:0]	
<b>VPchg[2:0]</b>	Pre-charge Voltage Threshold Setting 000 = 5.7V 001 = 5.8V 010 = 5.9V 111 = 6.0V 100 = 6.1V 101 = 6.2V 110 = 6.3V 111 = 6.4V							
<b>IPChg[1:0]</b>	Pre-charge Current Setting 00 = 0.05 x IFChg 01 = 0.1 x IFChg 10 = 0.2 x IFChg 11 = 0.3 x IFChg							
<b>ChgDone[1:0]</b>	Charge Done Threshold Setting 00 = 0.05 x IFChg 01 = 0.1 x IFChg 10 = 0.2 x IFChg 11 = Reserved							

**Table 35. ChargerCtrl3 Register (0x1F)**

ADDRESS:	0x1F							
MODE:	Read/Write or Read-Only if AppWrtPrct = "(1) Protected" (See Table 61)							
BIT	7	6	5	4	3	2	1	0
NAME	-	ChgAutoSta	MtChgTmr[1:0]		FChgTmr[1:0]		PChgTmr[1:0]	
<b>ChgAutoSta</b>	Charger Auto-Restart Control 0 = Charger remains in maintain charge done even when VBAT is less than BAT recharge threshold. 1 = Charger automatically restarts when VBAT drops below BAT recharge threshold.							
<b>MtChgTmr[1:0]</b>	Maintain Charge Timer Setting 00 = 0min 01 = 15min 10 = 30min 11 = 60min							
<b>FChgTmr[1:0]</b>	Fast- Charge Timer Setting 00 = 75min 01 = 150min 10 = 300min 11 = 600min							
<b>PChgTmr[1:0]</b>	Pre-charge Timer Setting 00 = 30min 01 = 60min 10 = 120min 11 = 240min							

**Table 36. ChargerCtrl4 Register (0x20)**

ADDRESS:	0x20							
MODE:	Read-Only				Read/Write or Read-Only if AppWrtPrct = "(1) Protected" (See Table 61)			
BIT	7	6	5	4	3	2	1	0
NAME	WeakBatStat[2:0]			-	-	WeakBatEn	-	-
<b>WeakBatStat[2:0]</b>	Weak Battery FSM status 000 = Idle, charger is not SDP 001 = Battery condition check 010 = Weak Battery 2-minute counter running 011 = Good Battery. 100 = Weak Battery 2-minute counter expired 101-111 = Reserved							
<b>WeakBatEna</b>	Weak Battery FSM Enable 0 = Disable 1 = Enable							

**Table 37. CurLimCtrl Register (0x21)**

ADDRESS:	0x21							
MODE:	Read/Write							
BIT	7	6	5	4	3	2	1	0
NAME	CurLim1Frc	FSUSMsk	-	CurLim1Set[4:0]				
<b>CurLim1Frc</b>	Forced Input Current Limit Enable. When CurLim1Frc is 1, the input current limit is by the CurLim1Set[4:0]. 0 = Not forced 1 = Forced							
<b>FSUSMsk</b>	FSUS pin function mask. If FSUSMsk is 1, FSUS pin status is ignored. 0 = FSUS pin function enabled 1 = FSUS pin function disabled							
<b>CurLim1Set[4:0]</b>	Forced Input Current Limit Value. The input current limit is forced to this value if CurLim1Frc is set to 1. 00000 = 0.10A 00001 = 0.20A ... 11101 = 3.00A 11110 = Reserved 11111 = Reserved							

**Table 38. CurLimStatus Register (0x22)**

<b>ADDRESS:</b>	<b>0x22</b>							
<b>MODE:</b>	<b>Read Only</b>							
<b>BIT</b>	<b>7</b>	<b>6</b>	<b>5</b>	<b>4</b>	<b>3</b>	<b>2</b>	<b>1</b>	<b>0</b>
<b>NAME</b>	CurLim2Rb[2:0]				SpvChgIlim[4:0]			
<b>CurLim2Rb[2:0]</b>	Active Charger/Boost current as percent of the value set by $R_{SET}$ . 0 = 20% 1 = 30% 2 = 40% 3 = 50% 4 = 60% 5 = 70% 6 = 80% 7 = 100%							
<b>SpvChgIlim[4:0]</b>	SpvChgIlim[4:0] shows the actual input current limit currently set. 00000 = 0.10A 00001 = 0.20A ... 11101 = 3.00A 11110 = Reserved 11111 = Reserved							

**Table 39. BBCFG1 Register (0x23)**

<b>ADDRESS:</b>	<b>0x23</b>							
<b>MODE:</b>	<b>Read/Write or Read-Only if AppWrtPrct = "(1) Protected" (See Table 61)</b>							
<b>BIT</b>	<b>7</b>	<b>6</b>	<b>5</b>	<b>4</b>	<b>3</b>	<b>2</b>	<b>1</b>	<b>0</b>
<b>NAME</b>	BoostRComp[3:0]				-	-	-	-
<b>BoostRComp[3:0]</b>	Sets the internal compensation resistor for the boost mode 0000 = 9.5kΩ 0001 = 17.3kΩ 0010 = 25.3kΩ 0011 = 33.2kΩ 0100 = 41.4kΩ 0101 = 49.2kΩ 0110 = 57.3kΩ 0111 = 65.1kΩ 1000 = 73.6kΩ 1001 = 81.4kΩ 1010 = 89.4kΩ 1011 = 97.2kΩ 1100 = 105.5kΩ 1101 = 113.3kΩ 1110 = 121.4kΩ 1111 = 129.2kΩ							

**Table 40. BBCFG2 Register (0x24)**

<b>ADDRESS:</b>	0x24							
<b>MODE:</b>	Read/Write or Read-Only if AppWrtPrct = "(1) Protected" (See Table 61)							
<b>BIT</b>	<b>7</b>	<b>6</b>	<b>5</b>	<b>4</b>	<b>3</b>	<b>2</b>	<b>1</b>	<b>0</b>
<b>NAME</b>	-	-	-	BBFrcZX	BuckVSet[3:0]			
<b>BBFrcZX</b>	BBFrcZX sets the Buck in forced ZX mode. 0 = Forced PWM Mode 1 = Forced ZX Mode							
<b>BuckVSet[3:0]</b>	Buck Regulation Voltage 0000 = 4.0V 0001 = 4.1V 0010 = 4.2V 0011 = 4.3V 0100 = 4.4V 0101 = 4.5V 0110 = 4.6V 0111 = 4.7V 1000 = 4.8V 1001 = 4.9V 1010 = 5.0V 1011 = 5.1V 1100 = 5.2V 1101 = 5.3V 1110 = 5.4V 1111 = 5.5V							

**Table 41. BC Ctrl1 Register (0x25)**

<b>ADDRESS:</b>	0x25							
<b>MODE:</b>	Read/Write							
<b>BIT</b>	<b>7</b>	<b>6</b>	<b>5</b>	<b>4</b>	<b>3</b>	<b>2</b>	<b>1</b>	<b>0</b>
<b>NAME</b>	DCD2s	SfOutLvl	-	ADC3PDet	SfOutCtrl[1:0]		ChgDetMan	ChgDetEn
<b>DCD2s</b>	DCD2s sets the timing of DCD in BC1.2 0 = standard 1 = 2s							
<b>SfOutLvl</b>	SFOUT Voltage Level Select 0 = 5V 1 = 3.3V							
<b>ADC3PDet</b>	3A DCP Detection Enable (adds detection step after BC1.2 completes to detect presence of 3A DCP) 0 = Not Enabled 1 = Enabled							
<b>SfOutCtrl[1:0]</b>	Safe Out LDO SFOUT Control 00 = Always Disabled 01 = On if a valid CHGIN voltage is present 10 = Turns on under following conditions. a. ChgDetEn = 1, CHGIN is valid, and BC1.2 FSM Detection is finished b. ChgDetEn = 0, and CHGIN is valid 11: RFU  <b>Note:</b> CHGIN valid can be external CHGIN voltage or CHGIN voltage generated by reverse buck in Attached. SRC_CCx mode. A system that supports power swap must not use SFOUT LDO to supply USB transceiver. According to USB PD specification, CHGIN will collapse during power swap. This turns off SFOUT LDO which is supplied from CHGIN, and kills USB communication.							
<b>ChgDetMan</b>	ChgDetMan forces manual run of charger detection. (Bit auto-resets to 0) 0 = Not enabled 1 = Request manual run of charger detection							
<b>ChgDetEn</b>	Charger Detection Enable 0 = Not enabled 1 = Enabled (charger detection runs every time $V_{CHGIN} > V_{BDET}$ and $DetAbrt = 0$ )							

**Table 42. Reserved Register (0x26)**

<b>ADDRESS:</b>	0x26							
<b>MODE:</b>	Read Only							
<b>BIT</b>	7	6	5	4	3	2	1	0
<b>NAME</b>	-	-	-	-	-	-	-	-

**Table 43. CCtrl1 Register (0x27)**

<b>ADDRESS:</b>	0x27							
<b>MODE:</b>	Read/Write							
<b>BIT</b>	7	6	5	4	3	2	1	0
<b>NAME</b>	-	-	-	CCSrcSnk	CCSnkSrc	CCDbgEn	CCAudEn	CCDetEn
<b>CCSrcSnk</b>	Allow State machine to enter Sink Mode (DFP) detection. Note USB PD role swap is allowed to enter Source mode. 0 = Disable 1 = Enable							
<b>CCSnkSrc</b>	Allow State machine to enter Source Mode (DFP) detection. Note USB PD role swap is allowed to enter Source mode. 0 = Disable 1 = Enabled							
<b>CCDbgEn</b>	Enable Detection of Type-C Debug Adapter 0 = Disabled 1 = Enabled							
<b>CCAudEn</b>	Enable Detection of Type-C Audio Adapter 0 = Disabled 1 = Enabled							
<b>CCDetEn</b>	Enable CC Pin Detection – Force State Machine to Disabled State. 0 = Disabled 1 = Enabled							

**Table 44. CCtrl2 Register (0x28)**

<b>ADDRESS:</b>	<b>0x28</b>							
<b>MODE:</b>	<b>Read/Write</b>							
<b>BIT</b>	<b>7</b>	<b>6</b>	<b>5</b>	<b>4</b>	<b>3</b>	<b>2</b>	<b>1</b>	<b>0</b>
<b>NAME</b>	CCForceError	SnkAttachedLock	CCSnkSrcSwp	CCSrcSnkSwp	CCVcnSwp	CCVcnEn	CCSrcRst	CCSnkRst
<b>CCForceError</b>	Bit resets to 0 after a write (This bit resets to 0 automatically when action is done) 0 = No action 1 = Force transition to ErrorRecovery state.							
<b>SnkAttachedLock</b>	Bit resets to 0 after a minimum of 1.1s 0 = Exit Attached.SNK* state when $V_{CHGIN} < V_{BDET}$ for more than $t_{PDDEB}$ 1 = Locked in Attached.SNK* state for a minimum of 1.1s if VBUS not present							
<b>CCSnkSrcSwp</b>	USB PD Power role swap from Sink to Source. This bit must be written to 0 once the USB PD controller completes the power role swap sequence 0 = No Swap Requested 1 = Swap Requested							
<b>CCSrcSnkSwp</b>	USB PD Power role swap from Source to Sink. This bit must be written to 0 once the USB PD controller completes the power role swap sequence 0 = No Swap Requested 1 = Swap Requested							
<b>CCVcnSwp</b>	Signal State Machine to Swap $V_{CONN}$ roles. Bit resets to 0 after a write (Note this bit will reset to 0 automatically when action is done) 0 = No change in $V_{CONN}$ role 1 = force change in $V_{CONN}$							
<b>CCVcnEn</b>	Force state of $V_{CONN}$ 0 = Force $V_{CONN}$ off (both external Buck converter and $V_{CONN}$ switch) 1 = Automatic operation based on State Machine							
<b>CCSrcRst</b>	Force a reset of the State Machine – Immediate transition to Unattached.SRC* state. Bit resets to 0 after a write. 0 = No reset 1 = Request reset							
<b>CCSnkRst</b>	Force a reset of the State Machine – Immediate transition to Unattached.SNK* state. Bit resets to 0 after a write. 0 = No reset 1 = Request reset							

\* Attached.SNK, Unattached.SRC, and Unattached.SNK are defined in USB Type-C Specification Release 1.1.

**Table 45. CCtrl3 Register (0x29)**

<b>ADDRESS:</b>	<b>0x29</b>							
<b>MODE:</b>	<b>Read/Write</b>							
<b>BIT</b>	<b>7</b>	<b>6</b>	<b>5</b>	<b>4</b>	<b>3</b>	<b>2</b>	<b>1</b>	<b>0</b>
<b>NAME</b>	-	-	-	-	CCTrySnk	CCPreferSnk	CCDRPPhase[1:0]	
<b>CCTrySnk</b>	Enable transition from AttachWait.SRC* to Try.SNK* then to Attach.SNK_CCx* or to TryWait.SRC* for DRP that strongly prefers the SNK role. CCTrySnk has higher priority than CCPreferSnk. 0 = Disabled 1 = Enabled							
<b>CCPreferSnk</b>	Enable transition from Unattached.SRC* to Try.SNK* then to Unattached.SNK* for DRP that strongly prefers the SNK role. 0 = Disabled 1 = Enabled							
<b>CCDRPPhase[1:0]</b>	Percent of time device is acting as Unattached.SRC* when CCSNKSRC = 1 00 = 35% 01 = 40% 10 = 45% 11 = 50%							

\* AttachWait.SRC, Try.SNK, Attached.SNK, TryWait.SRC, Unattached.SNK, and Unattached SRC are defined in USB Type-C Specification Release 1.1.

**Table 46. CHGINILim1 Register (0x2A)**

<b>ADDRESS:</b>	<b>0x2A</b>							
<b>MODE:</b>	<b>Read Only</b>							
<b>BIT</b>	<b>7</b>	<b>6</b>	<b>5</b>	<b>4</b>	<b>3</b>	<b>2</b>	<b>1</b>	<b>0</b>
<b>NAME</b>	-	CHGINILim[6:0]						
<b>CHGINILim[6:0]</b>	Status of charger input current limit set by charger detection (in 33mA step). Note that the first 4 codes are all 100mA. 0000000 = 100mA 0000001 = 100mA 0000010 = 100mA 0000011 = 100mA 0000100 = 133mA 0000011 = 166mA ... 1111111 = 4059mA							

**Table 47. CHGINILim2 Register (0x2B)**

ADDRESS:	0x2B							
MODE:	Read/Write							
BIT	7	6	5	4	3	2	1	0
NAME	-	-	-	-	CHGINILimGate	SDPMaxCur[1:0]		CDPMaxCur
<b>CHGINILimGate</b>	CHGINILim Control options 0 = No gating of CHGINILim setting by BC1.2 FSM 1 = Gate changes in CHGINILim until BC1.2 FSM completes – ChgTypRun = 0							
<b>SDPMaxCur[1:0]</b>	SDP Nonstandard Type-C Cable Control. USB-C to USB-A cables may have incorrect CC resistor indicating 1.5A or 3A. Requires CHGINILimGate = 1. 00 = No modification of CHGIN_LIM 01 = Limit SDP to 500mA. ChgTyp = 01 (SDP) and PrChgTyp = 000 (unknown) set CHGINILim[6:0] to 0x0F 10 = Limit SDP to 1.0A. ChgTyp = 01 (SDP) and PrChgTyp = 000 (unknown) set CHGINILim[6:0] to 0x1E 11 = Limit SDP to 1.5A. ChgTyp = 01 (SDP) and PrChgTyp = 000 (unknown) set CHGINILim[6:0] to 0x2D							
<b>CDPMaxCur</b>	CDP Nonstandard Type-C cable control. USB-C to USB-A cables may have incorrect CC resistor indicating 3A. Requires CHGIN_LIM_Gate = 1. 0 = No modification of CHGIN_LIM 1 = Limit CDP to 1.5A. ChgTyp = 10 (CDP) and PrChgTyp = 000 (unknown) set CHGINILim[6:0] to 0x2D							

**Table 48. AICLCFG1 Register (0x2C)**

ADDRESS:	0x2C							
MODE:	Read/Write or Read-Only if AppWrtPrctc = “(1) Protected” (See Table 61)							
BIT	7	6	5	4	3	2	1	0
NAME	AICLEn	-	-	-	-	-	-	AICLAbort
<b>AICLEn</b>	AICL Enable. Writing 1 to AICLEn enables AICL operation. Note that if AICLAbort is 1, AICL operation is not allowed. This bit auto-resets to 0. 0 = No Action 1 = AICL enabled							
<b>AICLAbort</b>	High Priority AICL Abort. 0 = Device is allowed to run AICL by writing 1 to AICLEn. 1 = Device is NOT allowed to run AICL operation. AICL operation will be aborted if it's already running.							

**Table 49. AICLCFG2 Register (0x2D)**

<b>ADDRESS:</b>	0x2D							
<b>MODE:</b>	Read/Write or Read-Only if AppWrtPrct = "(1) Protected" (See Table 61)							
<b>BIT</b>	7	6	5	4	3	2	1	0
<b>NAME</b>	BYPUVLO[2:0]			AICLMaxI[4:0]				
<b>BYPUVLO[2:0]</b>	VBUS Theshold below which AICL stops incrementing the current 000 = 3.8V 001 = 3.9V 010 = 4.0V 011 = 4.1V 100 = 4.2V 101 = 4.3V 110 = 4.4V 111 = 4.5V							
<b>AICLMaxI[4:0]</b>	AICL Stop Current (in 100mA step) 00000 = 100mA 00001 = 200mA ... 11111 = 3.2A							

**Table 50. AICLCFG3 Register (0x2E)**

<b>ADDRESS:</b>	0x2E							
<b>MODE:</b>	Read/Write or Read-Only if AppWrtPrct = "(1) Protected" (See Table 61)							
<b>BIT</b>	7	6	5	4	3	2	1	0
<b>NAME</b>	-	-	-	BYPDeb	AICLTBIk[1:0]		AICLTStep[1:0]	
<b>BYPDeb</b>	AICL BYPUVLO[2:0] Rise Threshold Debounce Setting 0 = 500µs 1 = 200µs							
<b>AICLTBIk[1:0]</b>	TBLANK Time Setting 00 = 500ms 01 = 1s 10 = 1.5s 11 = 5s							
<b>AICLTStep[1:0]</b>	TSTEP Time Setting 00 = 100ms 01 = 200ms 10 = 300ms 11 = 500ms							

**Table 51. DPDNSw Register (0x2F)**

<b>ADDRESS:</b>	0x2F							
<b>MODE:</b>	Read/Write							
<b>BIT</b>	7	6	5	4	3	2	1	0
<b>NAME</b>	-	-	-	-	-	-	AnSwCntl[1:0]	
<b>AnSwCntl[1:0]</b>	AnSwCntl Analog Switch Configuration 00 = Auto. Switch is open during adapter detection. Switch closes if SDP or CDP is detected. 01 = Auto in SDP or CDP and Buck mode is detected. 10 = Switch forced open 11 = Switch forced closed							

**Table 52. Others Register (0x30)**

<b>ADDRESS:</b>	0x30							
<b>MODE:</b>	Read/Write							
<b>BIT</b>	7	6	5	4	3	2	1	0
<b>NAME</b>	-	-	-	-	-	-	-	USBCRSet
<b>USBCRSet</b>	USB-C Registers Reset. Writing 1 to USBCRSet resets registers associated with USB-C operation. (Note that this operation opens the input limiter and turns off the boost converter temporarily.) Reset types are RST3 and RST4. See Table 59 and Table 60 for more details. This bit auto-resets to 0. 0 = No Action 1 = Reset Registers							

**Table 53. Reserved Register (0x31)**

<b>ADDRESS:</b>	0x31							
<b>MODE:</b>	Read Only							
<b>BIT</b>	7	6	5	4	3	2	1	0
<b>NAME</b>	-	-	-	-	-	-	-	-

**Table 54. Reserved Register (0x32)**

<b>ADDRESS:</b>	0x32							
<b>MODE:</b>	Read Only							
<b>BIT</b>	7	6	5	4	3	2	1	0
<b>NAME</b>	-	-	-	-	-	-	-	-

**Table 55. LowPow Register (0x33)**

<b>ADDRESS:</b>	0x33							
<b>MODE:</b>	Read/Write							
<b>BIT</b>	7	6	5	4	3	2	1	0
<b>NAME</b>	LowPowEn	-	-	-	-	-	-	LowPowAbort
<b>LowPowEn</b>	<p>Low Power Mode Enable. Set LowPowEn to 1 to enter Low Power mode. Note that if LowPowAbort is 1, Low Power Mode is not allowed. This bit auto-resets to 0.</p> <p>0 = No Action 1 = Enter Low Power mode</p>							
<b>LowPowAbort</b>	<p>High Priority Low Power Mode Abort</p> <p>0 = Device is allowed to enter Low Power mode by writing 1 to LowPowEn. 1 = Device is NOT allowed to enter Low Power Mode. Low Power Mode will be exited if device has already entered it.</p>							

**Table 56. Reserved Register (0x34)**

<b>ADDRESS:</b>	0x34							
<b>MODE:</b>	Read Only							
<b>BIT</b>	7	6	5	4	3	2	1	0
<b>NAME</b>	-	-	-	-	-	-	-	-

**Table 57. FLTSEL Register (0x35)**

<b>ADDRESS:</b>	0x35							
<b>MODE:</b>	Read/Write							
<b>BIT</b>	7	6	5	4	3	2	1	0
<b>NAME</b>	FLTSelect[1:0]		-	-	-	-	-	-
<b>FLTSelect[10]</b>	<p><math>\overline{\text{FLTIN}}</math> Charger-Faulting and External Reset Function Enable</p> <p>00 = No effect and internally ignored</p> <p>01 = Low on <math>\overline{\text{FLTIN}}</math> pin (60<math>\mu</math>s debounce) places the charger in Battery Fault Charge Suspend state (ChgStat[3:0] = 1000).</p> <p>1x = Falling edge on <math>\overline{\text{FLTIN}}</math> pin resets all registers. Reset types are RST1/RST2/RST3. See Table 59 and Table 60 for more details.</p>							

## Applications Information

### Component Selection

The correct selection of external components ensures high efficiency, low output ripple, and fast transient response.

### Inductor Selection

The MAX14748 is designed to use a 1.5 $\mu$ H or 2.2 $\mu$ H inductor. See [Table 58](#) for suggested inductors and manufacturers.

### BAT Capacitor Selection

BAT capacitor is required to keep the BAT voltage ripple small and to ensure regulation loop stability. The BAT capacitor must have low impedance at the switching frequency. Ceramic capacitors with X5R or X7R dielectric are highly recommended due to their small size, low ESR, and small temperature coefficients.

BAT requires careful bypassing. In the PCB layout, place BAT capacitor as close as possible to BAT to minimize parasitic inductance. If making connections to BAT capacitor through vias, ensure that the vias are rated for the expected input current to avoid excess inductance and resistance between the capacitor and BAT.

The recommended nominal BAT capacitance is 22 $\mu$ F, however, after initial tolerance, bias voltage, aging, and temperature derating, the effective capacitance must be greater than 10 $\mu$ F. To ensure regulation loop stability, the effective BAT capacitance should be chosen within the range of 10 $\mu$ F to 30 $\mu$ F.

### SYS Capacitor Selection

SYS capacitor acts as the output capacitor for the boost converter when charging, and the input capacitor for the reverse buck converter when the device is acting as power source in DRP mode. SYS capacitor is required to keep the SYS voltage ripple small and to ensure regulation loop stability. It must have low impedance at the switching frequency. Ceramic capacitors with X5R or X7R dielectric are highly recommended due to their small size, low ESR, and small temperature coefficients.

Place SYS capacitor as close as possible to SYS to minimize parasitic inductance. If making connections to SYS capacitor through vias, ensure that the vias are rated for the expected input current to avoid excess inductance and resistance between the capacitor and SYS.

The recommended nominal SYS capacitance is 40 $\mu$ F, however, after initial tolerance, bias voltage, aging, and temperature derating, the effective capacitance must be greater than 15 $\mu$ F.

### BYP Capacitor Selection

BYP capacitor acts as the input capacitor for the boost converter, and the output capacitor for the reverse buck converter. BYP capacitor reduces the current peaks drawn from the input power source when charging while reducing the output voltage ripple of the reverse buck converter when it is acting as power source in DRP mode. The impedance of the input capacitor at the switching frequency should be very low. Ceramic capacitors with X5R or X7R dielectric are highly recommended due to their small size, low ESR, and small temperature coefficients.

**Table 58. Suggested Inductors**

APPLICATION	INDUCTANCE ( $\mu$ H)	R <sub>DC</sub> (m $\Omega$ )	SATURATION CURRENT (A)	CURRENT RATING (A)	SUGGESTED PARTS
3A Type-C Adapters	2.2 $\mu$ H	26	4.2	3.7	Taiyo Yuden NRS6028T2R2NMGJ
	2.2 $\mu$ H	80	3.5	2.8	BOURNS SRP4012TA-2R2M

**Table 59. Reset Types**

RESET TYPE	RESET CONDITION
RST	1. V <sub>CCINT</sub> Power-On Reset
RST1	1. V <sub>CCINT</sub> Power-On Reset or 2. $\overline{\text{FLTIN}}$ falling edge (only if FLTSelect[1] = 1)
RST2	1. V <sub>CCINT</sub> Power-On Reset or 2. $\overline{\text{FLTIN}}$ falling edge (only if FLTSelect[1] = 1)
RST3	1. V <sub>CCINT</sub> Power-On Reset or 2. $\overline{\text{FLTIN}}$ falling edge (only if FLTSelect[1] = 1) or 3. USB-C reset through USBCRSet (0x30[0])

BYP requires careful bypassing. In the PCB layout, place BYP capacitor as close as possible to the BYP to minimize parasitic inductance. If making connections to BYP capacitor through vias, ensure that the vias are rated for the expected input current to avoid excess inductance and resistance between the capacitor and BYP.

The recommended nominal BYP capacitance is 22 $\mu$ F, however, after initial tolerance, bias voltage, aging, and temperature derating, the effective capacitance must be greater than 10 $\mu$ F.

### CHGIN Capacitor Selection

CHGIN capacitor decouples a charge source and its parasitic impedance. Typically, the charge source at CHGIN is a USB connector's VBUS. The recommended nominal CHGIN capacitance is 1 $\mu$ F. Larger capacitance at CHGIN improves the decoupling; however, take care not to exceed the maximum capacitance allowed by the USB specification.

The impedance of the CHGIN at the DC-DC switching frequency should be very low. Ceramic capacitors with X5R or X7R dielectric are highly recommended due to their small size, low ESR, and small temperature coefficients.

To fully utilize the +30V input capability of the, choose a capacitor with a 35V or greater rating; many applications don't need to utilize the full input capability of the device and find that a 16V or 10V rated input capacitor is sufficient.

### BST Capacitor Selection

Choose the nominal BST capacitance to be 0.1 $\mu$ F. BST capacitor is part of a charge pump that creates the high-side gate drive for the DC-DC. It is recommended that the BST capacitor has at least 10V rating.

### PCB Layout and Routing

High switching frequencies and large peak currents make PCB layout a very important part of design. Good design minimizes excessive EMI on the feedback paths and voltage gradients in the ground plane, both of which can result in instability or regulation errors. Connect the inductor, input capacitors, and output capacitors as close together as possible, and keep their traces short, direct, and wide. Keep noisy traces, such as the LX node, as short as possible.

Table 60. Register Reset Types and Default Values

REGISTER ADDRESS	REGISTER NAME	RESET TYPE	MAX14748
0x00	ChipID	RST1	0x3E
0x01	ChipRev	RST1	0x33
0x01 (MAX14748B)	ChipRev	RST1	0x44
0x02	DevStatus1	RST1	STATUS*
0x03	AICLStatus	RST1	STATUS
0x04	DevStatus2	RST1	STATUS
0x05	ChgStatus	RST1	STATUS
0x06	JEITAStatus	RST1	STATUS
0x07	BCStatus	RST3	STATUS
0x08	Reserved	—	0x00
0x09	CCStatus1	RST3	STATUS
0x0A	CCStatus2	RST3	STATUS
0x0B	DevInt1	RST1	INT*
0x0C	AICLInt	RST1	INT
0x0D	DevInt2	RST1	INT
0x0E	ChgInt	RST1	INT
0x0F	JEITAInt	RST1	INT
0x10	BCInt	RST3	INT
0x11	CCInt	RST3	INT
0x12	DevInt1Mask	RST1	0xFF
0x13	AICLIntMask	RST1	0x40
0x14	DevInt2Mask	RST1	0x7F
0x15	ChgIntMask	RST1	0xF1
0x16	JEITAIntMask	RST1	0x19
0x17	BCIntMask	RST3	0xFF
0x18	CCIntMask	RST3	0x7F
0x19	LED_CTRL	RST1	0x00
0x1A	ThermaCfg1	RST2	0x7D
0x1B	ThermaCfg2	RST2	0xEF

REGISTER ADDRESS	REGISTER NAME	RESET TYPE	MAX14748
0x1C	ThermaCfg3	RST2	0x02
0x1D	ChargerCtrl1	RST2	0x80
0x1E	ChargerCtrl2	RST2	0x10
0x1F	ChargerCtrl3	RST2	0x49
0x20	ChargerCtrl4**	RST2	0x06
0x21	CurLimCtrl	RST2	0x00
0x22	CurLimStatus	RST1	STATUS
0x23	BBCFG1	RST1	0x20
0x24	BBCFG2	RST1	0x8A
0x25	BCCtrl1	RST3	0x05
0x26	Reserved	—	0x00
0x27	CCCtrl1	RST3	0x19
0x27 (MAX14748B)	CCCtrl1	RST3	0x11
0x28	CCCtrl2	RST3	0x04
0x29	CCCtrl3	RST3	0x08
0x2A	CHGINILim1	RST3	STATUS
0x2B	CHGINILim2	RST3	0x0B
0x2C	AICLCFG1	RST1	0x01
0x2D	AICLCFG2	RST1	0x44
0x2E	AICLCFG3	RST1	0x05
0x2F	DPDNSw	RST2	0x01
0x30	Others	RST1	0x00
0x31	Reserved	—	0x00
0x32	Reserved	—	0x00
0x33	LowPow	RST1	0x01
0x34	Reserved	—	0x01
0x35	FLTSEL	RST	0x80

\*INT and STATUS: status and interrupt register values vary based on device operating condition.

\*\* ChargerCtrl4 register value depends on the status of WeakBatStat[2:0] bits.

**Table 61. Register Bit Default Values**

REGISTER BITS	VALUES
CDPMaxCur	1500mA
SDPMaxCur[1:0]	500mA
CHGINLimGate	Gating
CCAudEn	Disabled
CCDbgEn	Disabled
CCSnkSrc	Disabled
CCSrcSnk	Enabled
JeitaCfgR[1:0]	"01"
CCDRPPhase[1]	35% or 40%
CCTrySnk	Enabled
SfOutCtrl[1:0]	"01"
ADC3PDet	Disabled
DCD2s	Standard
WarmCoolSel	45°C/10°C
T1T2IFchg[2:0]	0.5 x IFChg
T3T4IFchg[2:0]	1.0 x IFChg
BatReg[1:0]	8.3V
ChgEn	Disabled
JETIActrSet	(1) Control
IPChg[1:0]	0.05 x IFChg
ChgDone[1:0]	0.05 x IFChg
ChgAutoStp	Enabled
BatReChg[1:0]	200mV

REGISTER BITS	VALUES
FreshBatDis	Done
ChgAutoSta	Enabled
MtChgTmr[1:0]	0min
FChgTmr[1:0]	300min
PChgTmr[1:0]	60min
ChipRevH[3:0]	3
AppWrtPrctct	(0) Writable
VPchg[2:0]	5.8V
T3T4ENset	Enabled
T1T2ENset	Enabled
T3T4VFset	Enabled
T1T2VFset	Enabled
T2T3IFchg[2:0]	1.0 x IFChg
BoostRComp[3:0]	2
FLTSelect[1:0]	(10) Reset
BuckVSet[3:0]	5.0V
AnSwCntl[1:0]	(01) Auto
AICLTStep[1:0]	200ms
WeakBatEna	Enabled
BYPUVLO[2:0]	4.0V
AICLMax[4:0]	500mA
BYPDeb	500µs
AICLTBlk[1:0]	1000ms



## Ordering Information

PART	TEMP RANGE	PIN-PACKAGE
MAX14748EWW+	-40°C to +85°C	54 WLP
MAX14748EWW+T	-40°C to +85°C	54 WLP
MAX14748BEWW+	-40°C to +85°C	54 WLP
MAX14748BEWW+T	-40°C to +85°C	54 WLP

+Denotes a lead(Pb)-free package/RoHS-compliant package.

See [Table 61](#) for the device differences.

T = Tape and reel.

## Chip Information

PROCESS: BiCMOS

## Revision History

REVISION NUMBER	REVISION DATE	DESCRIPTION	PAGES CHANGED
0	6/17	Initial release	—
1	12/17	Added MAX14748C as future product	1, 6, 27, 29, 35, 36, 52, 58, 59, 67, 68, 70
2	3/18	Updated <i>Bump Configuration</i> , Figure 4, <i>Register Map</i> , Table 33, Table 60, and <i>Ordering Information</i> table	15, 27, 35, 52,
3	4/18	Updated the <i>Electrical Characteristics</i> table, <i>Register Map</i> , Tables 8, 17, 24, 33	3, 35, 38, 43, 47, 52
3.1	5/18	Corrected <i>Bump Configuration</i> diagram	15
4	5/18	Corrected <i>Bump Configuration</i> diagram	15
5	9/18	Updated the <i>Electrical Characteristics</i> table, <i>Typical Operating Characteristics</i> global conditions, and Table 60.	2–14, 67
6	10/18	Updated Table 59 and Table 61; corrected footnote and formatting for Table 3, and corrected typos in Register Tables to say “Read-Only”	36, 52–56, 61–62, 65, 68
7	3/19	Updated the <i>Electrical Characteristics</i> table and Figure 4	8, 27
8	7/19	Added the <i>Deeply Discharged Battery</i> section	30

For pricing, delivery, and ordering information, please visit Maxim Integrated's online storefront at <https://www.maximintegrated.com/en/storefront/storefront.html>.

Maxim Integrated cannot assume responsibility for use of any circuitry other than circuitry entirely embodied in a Maxim Integrated product. No circuit patent licenses are implied. Maxim Integrated reserves the right to change the circuitry and specifications without notice at any time. The parametric values (min and max limits) shown in the *Electrical Characteristics* table are guaranteed. Other parametric values quoted in this data sheet are provided for guidance.