



Low-Power, Current Feedback OPERATIONAL AMPLIFIER With Disable

FEATURES

- MINIMAL BANDWIDTH CHANGE VERSUS GAIN
- > 120MHz BANDWIDTH TO GAIN > +10
- LOW DISTORTION: < -78dBc at 5MHz
- HIGH OUTPUT CURRENT: 120mA
- SINGLE +5V TO +12V SUPPLY OPERATION
- DUAL ±2.5 TO ±6.0V SUPPLY OPERATION
- LOW SUPPLY CURRENT: 1.7mA
- LOW SHUTDOWN CURRENT: 100µA

APPLICATIONS

- LOW-POWER BROADCAST VIDEO DRIVERS
- EQUALIZING FILTERS
- SAW FILTER HIGH GAIN POST AMPLIFIERS
- MULTICHANNEL SUMMING AMPLIFIERS
- PROFESSIONAL CAMERAS
- ADC INPUT DRIVERS

DESCRIPTION

The OPA684 provides a new level of performance in low-power, wideband, current-feedback (CFB) amplifiers. This CFB_{plus} amplifier is the first to use an internally closed-loop input buffer stage that enhances performance significantly over earlier low-power CFB amplifiers. While retaining the benefits of very low power operation, this new architecture provides many of the benefits of a more ideal CFB amplifier. The closed-loop input stage buffer gives a very low and linearized impedance path at the inverting input to sense the feedback error current. This improved inverting input impedance retains exceptional bandwidth to much higher gains and improves harmonic distortion over earlier solutions limited by inverting input linearity. Beyond simple high-gain applications, the OPA684 CFB_{plus} amplifier permits the gain setting element to be set with considerable freedom from amplifier bandwidth interaction. This allows frequency response peaking elements to be added, multiple input inverting summing circuits to have greater bandwidth, and low-

power line drivers to meet the demanding requirements of studio cameras and broadcast video.

The output capability of the OPA684 also sets a new mark in performance for low-power current feedback amplifiers. Delivering a full ±4V_{PP} swing on ±5V supplies, the OPA684 also has the output current to support this swing into a 100Ω load. This minimal output headroom requirement is complemented by a similar 1.2V input stage headroom giving exceptional capability for single +5V operation.

The OPA684's low 1.7mA supply current is precisely trimmed at 25°C. This trim, along with low shift over temperature and supply voltage, gives a very robust design over a wide range of operating conditions. System power may be further reduced by using the optional disable control pin. Leaving this disable pin open, or holding it HIGH, gives normal operation. If pulled LOW, the OPA684 supply current drops to less than 100µA while the I/O pins go to a high impedance state.

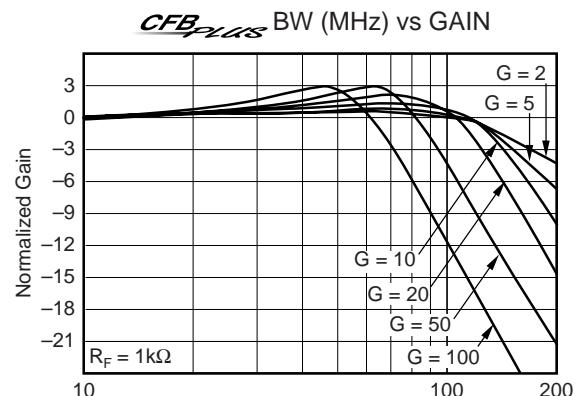
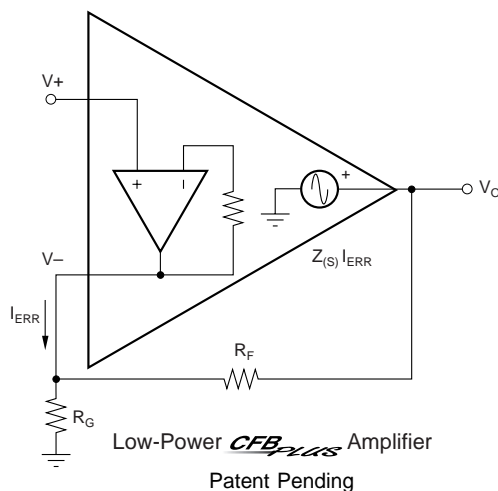

Please be aware that an important notice concerning availability, standard warranty, and use in critical applications of Texas Instruments semiconductor products and disclaimers thereto appears at the end of this data sheet.

All trademarks are the property of their respective owners.

PRODUCTION DATA information is current as of publication date. Products conform to specifications per the terms of Texas Instruments standard warranty. Production processing does not necessarily include testing of all parameters.

ABSOLUTE MAXIMUM RATINGS⁽¹⁾

Power Supply	$\pm 6.5V_{DC}$
Internal Power Dissipation	See Thermal Information
Differential Input Voltage	$\pm 1.2V$
Input Voltage Range	$\pm V_S$
Storage Temperature Range: ID, IDBV	$-65^{\circ}C$ to $+125^{\circ}C$
Junction Temperature (T_J)	$+175^{\circ}C$

NOTE: (1) Stresses above these ratings may cause permanent damage. Exposure to absolute maximum conditions for extended periods may degrade device reliability.

OPA684 RELATED PRODUCTS

SINGLES	DUALS	TRIPLES	FEATURES
OPA684	OPA2684	OPA3684	Low-Power CFB _{plus}
OPA691	OPA2691	OPA3691	High Slew Rate CFB
OPA695	OPA2695	OPA3695	> 500MHz CFB



ELECTROSTATIC DISCHARGE SENSITIVITY

This integrated circuit can be damaged by ESD. Texas Instruments recommends that all integrated circuits be handled with appropriate precautions. Failure to observe proper handling and installation procedures can cause damage.

ESD damage can range from subtle performance degradation to complete device failure. Precision integrated circuits may be more susceptible to damage because very small parametric changes could cause the device not to meet its published specifications.

PACKAGE/ORDERING INFORMATION⁽¹⁾

PRODUCT	PACKAGE-LEAD	PACKAGE DESIGNATOR	SPECIFIED TEMPERATURE RANGE	PACKAGE MARKING	ORDERING NUMBER	TRANSPORT MEDIA, QUANTITY
OPA684	SO-8	D	$-40^{\circ}C$ to $+85^{\circ}C$	OPA684D	OPA684ID	Rails, 100
"	"	"	"	"	OPA684IDR	Tape and Reel, 2500
OPA684	SOT23-6	DBV	$-40^{\circ}C$ to $+85^{\circ}C$	B84	OPA684IDBVT	Tape and Reel, 250
"	"	"	"	"	OPA684IDBVR	Tape and Reel, 3000

NOTE: (1) For the most current package and ordering information, see the Package Option Addendum located at the end of this document, or see the TI website at www.ti.com.

PIN CONFIGURATION

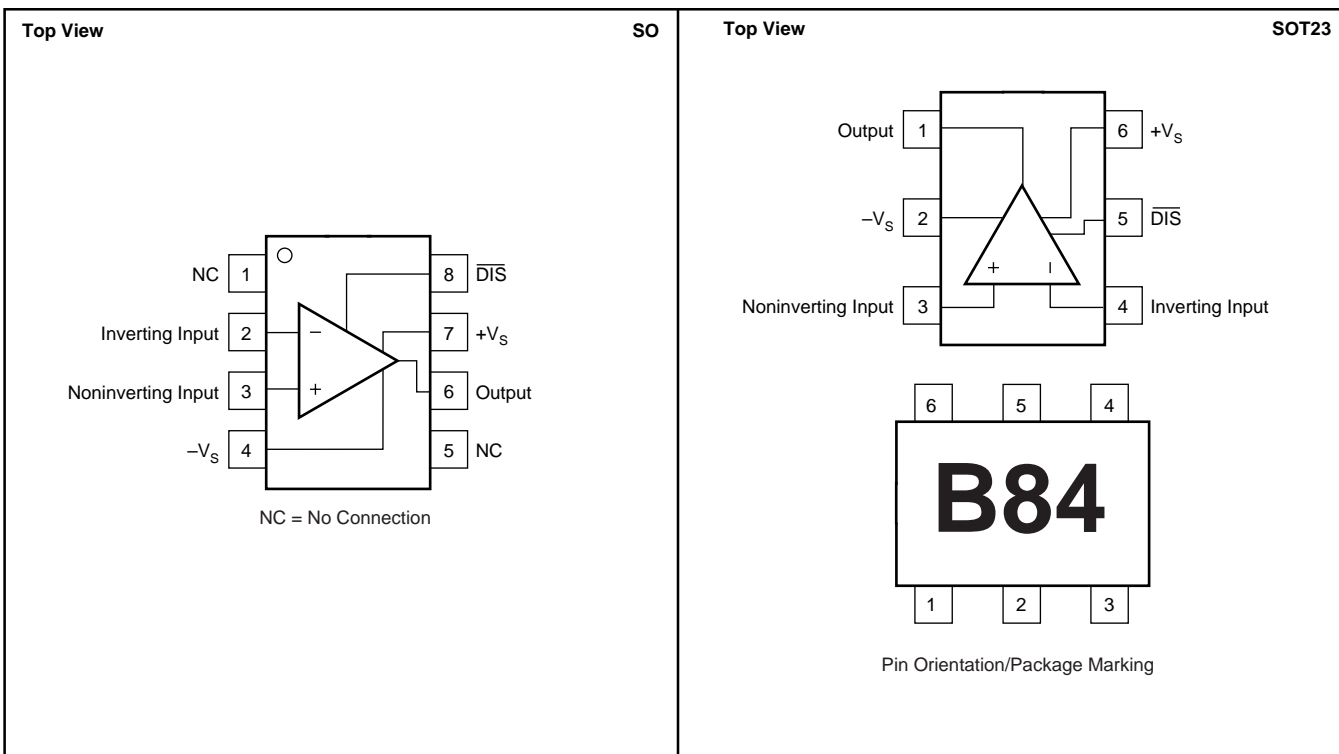

ELECTRICAL CHARACTERISTICS: $V_S = \pm 5V$

$R_F = 1k\Omega$, $R_L = 100\Omega$, and $G = +2$, (See Figure 1 for AC performance only), unless otherwise noted.

PARAMETER	CONDITIONS	OPA684ID, IDBV						TEST LEVEL ⁽³⁾	
		TYP	MIN/MAX OVER TEMPERATURE						
		+25°C	+25°C ⁽¹⁾	0°C to 70°C ⁽²⁾	-40°C to +85°C ⁽²⁾	UNITS	MIN/MAX		
AC PERFORMANCE (See Figure 1) Small-Signal Bandwidth ($V_O = 0.5V_{PP}$)	$G = +1, R_F = 1k\Omega$ $G = +2, R_F = 1k\Omega$ $G = +5, R_F = 1k\Omega$ $G = +10, R_F = 1k\Omega$ $G = +20, R_F = 1k\Omega$	210 160 134 120 104					MHz MHz MHz MHz MHz	typ min typ typ typ	C B C C C
Bandwidth for 0.1dB Gain Flatness	$G = +2, V_O = 0.5V_{PP}, R_F = 1k\Omega$	19	16	14	14	MHz	min	B	
Peaking at a Gain of +1	$R_F = 1k\Omega, V_O = 0.5V_{PP}$	1.4	4.8	5.9	6.3	dB	max	B	
Large-Signal Bandwidth	$G = +2, V_O = 4V_{PP}$	90				MHz	typ	C	
Slew Rate	$G = -1, V_O = 4V$ Step	820	675	650	575	V/ μ s	min	B	
	$G = +2, V_O = 4V$ Step	750	650	620	590	V/ μ s	min	B	
Rise-and-Fall Time	$G = +2, V_O = 0.5V$ Step	3				ns	typ	C	
	$G = +2, V_O = 4V$ Step	6.8				ns	typ	C	
Harmonic Distortion	$G = +2, f = 5MHz, V_O = 2V_{PP}$								
2nd-Harmonic	$R_L = 100\Omega$	-67	-59	-59	-58	dBc	max	B	
	$R_L \geq 1k\Omega$	-78	-64	-64	-63	dBc	max	B	
3rd-Harmonic	$R_L = 100\Omega$	-70	-66	-65	-65	dBc	max	B	
	$R_L \geq 1k\Omega$	-89	-82	-81	-81	dBc	max	B	
Input Voltage Noise	$f > 1MHz$	3.7	4.1	4.2	4.4	nV/ \sqrt{Hz}	max	B	
Non-inverting Input Current Noise	$f > 1MHz$	9.4	11	12	12.5	pA/ \sqrt{Hz}	max	B	
Inverting Input Current Noise	$f > 1MHz$	17	18	18.5	19	pA/ \sqrt{Hz}	max	B	
Differential Gain	$G = +2, NTSC, V_O = 1.4Vp, R_L = 150\Omega$	0.04				%	typ	C	
Differential Phase	$G = +2, NTSC, V_O = 1.4Vp, R_L = 150\Omega$	0.02				deg	typ	C	
DC PERFORMANCE⁽⁴⁾									
Open-Loop Transimpedance Gain (Z_{OL})	$V_O = 0V, R_L = 1k\Omega$	355	160	155	153	k Ω	min	A	
Input Offset Voltage	$V_{CM} = 0V$	± 1.5	± 3.5	± 4.1	± 4.3	mV	max	A	
Average Offset Voltage Drift	$V_{CM} = 0V$			± 12	± 12	$\mu V/^\circ C$	max	B	
Non-inverting Input Bias Current	$V_{CM} = 0V$	± 5.0	± 10	± 11.5	± 12	μA	max	A	
Average Non-inverting Input Bias Current Drift	$V_{CM} = 0V$			± 25	± 30	nA/ $^\circ C$	max	B	
Inverting Input Bias Current	$V_{CM} = 0V$	± 5.0	± 16	± 17.5	± 18.5	μA	max	A	
Average Inverting Input Bias Current Drift	$V_{CM} = 0V$			± 35	± 40	nA/ $^\circ C$	max	B	
INPUT									
Common-Mode Input Range ⁽⁵⁾ (CMIR)		± 3.75	± 3.65	± 3.65	± 3.6	V	min	A	
Common-Mode Rejection Ratio (CMRR)	$V_{CM} = 0V$	60	53	52	52	dB	min	A	
Non-inverting Input Impedance		50 2				k Ω pF	typ	C	
Inverting Input Resistance (R_i)	Open-Loop, DC	2.5				Ω	typ	C	
OUTPUT									
Voltage Output Swing	1k Ω Load	± 4.1	± 4.0	± 4.0	± 3.9	V	min	A	
Current Output, Sourcing	$V_O = 0$	160	140	135	130	mA	min	A	
Current Output, Sinking	$V_O = 0$	-120	-110	-105	-100	mA	min	A	
Closed-Loop Output Impedance	$G = +2, f = 100kHz$	0.006				Ω	typ	C	
DISABLE (Disabled Low)									
Power-Down Supply Current ($+V_{S}$)	$V_{DIS} = 0$	-100	-150	-170	-180	μA	max	A	
Disable Time	$V_{IN} = +1V, G = +2$	4				ms	typ	C	
Enable Time	$V_{IN} = +1V, G = +2$	40				ns	typ	C	
Off Isolation	$G = +2, 5MHz$	70				dB	typ	C	
Output Capacitance in Disable		1.7				pF	typ	C	
Enable Voltage		3.4	3.5	3.6	3.7	V	min	A	
Disable Voltage		1.8	1.7	1.6	1.5	V	max	A	
Control Pin Input Bias Current (\overline{DIS})	$V_{DIS} = 0V$	80	120	130	135	μA	max	A	
POWER SUPPLY									
Specified Operating Voltage		± 5				V	typ	C	
Maximum Operating Voltage Range			± 6	± 6	± 6	V	max	A	
Minimum Operating Voltage Range		± 1.4				V	min	C	
Max Quiescent Current	$V_S = \pm 5V$	1.7	1.8	1.85	1.85	mA	max	A	
Min Quiescent Current	$V_S = \pm 5V$	1.7	1.6	1.55	1.45	mA	min	A	
Power-Supply Rejection Ratio ($-PSRR$)	Input Referred	60	54	53	53	dB	typ	A	
TEMPERATURE RANGE									
Specification: ID, IDBV		-40 to +85				$^\circ C$	typ	C	
Thermal Resistance, θ_{JA}	Junction-to-Ambient					$^\circ C/W$	typ	C	
D SO-8		125				$^\circ C/W$	typ	C	
DBV SOT-23-6		150				$^\circ C/W$	typ	C	

NOTES: (1) Junction temperature = ambient for 25°C tested specifications. (2) Junction temperature = ambient at low temperature limit, junction temperature = ambient +2°C at high temperature limit for over temperature tested specifications. (3) Test levels: (A) 100% tested at 25°C. Over temperature limits by characterization and simulation. (B) Limits set by characterization and simulation. (C) Typical value only for information. (4) Current is considered positive out-of-node. V_{CM} is the input common-mode voltage. (5) Tested < 3dB below minimum specified CMR at \pm CMIR limits.

ELECTRICAL CHARACTERISTICS: $V_S = +5V$

$R_F = 1.3k\Omega$, $R_L = 100\Omega$, and $G = +2$, (See Figure 3 for AC performance only), unless otherwise noted.

PARAMETER	CONDITIONS	OPA684ID, IDBV						TEST LEVEL ⁽³⁾
		TYP	MIN/MAX OVER TEMPERATURE					
		+25°C	+25°C ⁽¹⁾	0°C to 70°C ⁽²⁾	-40°C to +85°C ⁽²⁾	UNITS	MIN/MAX	
AC PERFORMANCE (See Figure 3)								
Small-Signal Bandwidth ($V_O = 0.5V_{PP}$)	$G = +1, R_F = 1.3k\Omega$	146				MHz	typ	C
	$G = +2, R_F = 1.3k\Omega$	105	79	76	69	MHz	min	B
	$G = +5, R_F = 1.3k\Omega$	95				MHz	min	C
	$G = +10, R_F = 1.3k\Omega$	87				MHz	typ	C
	$G = +20, R_F = 1.3k\Omega$	79				MHz	typ	C
Bandwidth for 0.1dB Gain Flatness	$G = +2, V_O < 0.5V_{PP}, R_F = 1.3k\Omega$	21	12	11	10	MHz	min	B
Peaking at a Gain of +1	$R_F = 1.3k\Omega, V_O < 0.5V_{PP}$	0.5	2.6	3.4	3.7	dB	max	B
Large-Signal Bandwidth	$G = 2, V_O = 2V_{PP}$	86				MHz	typ	C
Slew Rate	$G = 2, V_O = 2V$ Step	300	240	235	225	V/ μ s	min	B
	$G = 2, V_O = 0.5V$ Step	4.3				ns	typ	C
Rise-and-Fall Time	$G = 2, V_O = 2V$ Step	5.3				ns	typ	C
Harmonic Distortion	$G = 2, f = 5MHz, V_O = 2V_{PP}$							
2nd-Harmonic	$R_L = 100\Omega$ to $V_S/2$	65	57	57	56	dBc	max	B
	$R_L \geq 1k\Omega$ to $V_S/2$	65	58	57	57	dBc	max	B
3rd-Harmonic	$R_L = 100\Omega$ to $V_S/2$	65	64	63	63	dBc	max	B
	$R_L \geq 1k\Omega$ to $V_S/2$	71	70	70	69	dBc	max	B
Input Voltage Noise	$f > 1MHz$	3.7	4.1	4.2	4.4	nV/ \sqrt{Hz}	max	B
Non-inverting Input Current Noise	$f > 1MHz$	9.4	11	12	12.5	pA/ \sqrt{Hz}	max	B
Inverting Input Current Noise	$f > 1MHz$	17	18	18.5	19	pA/ \sqrt{Hz}	max	B
Differential Gain	$G = +2, NTSC, V_O = 1.4Vp, R_L = 150\Omega$	0.04				%	typ	C
Differential Phase	$G = +2, NTSC, V_O = 1.4Vp, R_L = 150\Omega$	0.07				deg	typ	C
DC PERFORMANCE⁽⁴⁾								
Open-Loop Transimpedance Gain (Z_{OL})	$V_O = V_S/2, R_L = 100\Omega$ to $V_S/2$	325	160	155	153	k Ω	min	A
Input Offset Voltage	$V_{CM} = V_S/2$	± 1.0	± 3.0	± 3.6	± 3.8	mV	max	A
Average Offset Voltage Drift	$V_{CM} = V_S/2$			± 12	± 12	μ V/ $^{\circ}$ C	max	B
Non-inverting Input Bias Current	$V_{CM} = V_S/2$	± 5	± 10	± 11.5	± 12	μ A	max	A
Average Non-inverting Input Bias Current Drift	$V_{CM} = V_S/2$			± 25	± 30	nA/ $^{\circ}$ C	max	B
Inverting Input Bias Current	$V_{CM} = V_S/2$	± 5	± 12	± 13.5	± 15	μ A	max	A
Average Inverting Input Bias Current Drift	$V_{CM} = V_S/2$			± 25	± 30	nA/ $^{\circ}$ C	max	B
INPUT								
Least Positive Input Voltage ⁽⁵⁾		1.25	1.32	1.35	1.38	V	max	A
Most Positive Input Voltage ⁽⁵⁾		3.75	3.68	3.65	3.62	V	min	A
Common-Mode Rejection Ratio (CMRR)	$V_{CM} = V_S/2$	58	52	51	51	dB	min	A
Non-inverting Input Impedance		50 1				k Ω pF	typ	C
Inverting Input Resistance (R_i)	Open-Loop	2.5				Ω	typ	C
OUTPUT								
Most Positive Output Voltage	$R_L = 1k\Omega$ to $V_S/2$	4.10	4.0	4.0	3.9	V	min	A
Least Positive Output Voltage	$R_L = 1k\Omega$ to $V_S/2$	0.9	1.0	1.0	1.1	V	max	A
Current Output, Sourcing	$V_O = V_S/2$	80	70	65	60	mA	min	A
Current Output, Sinking	$V_O = V_S/2$	70	58	53	48	mA	min	A
Closed-Loop Output Impedance	$G = +2, f = 100kHz$	0.006				Ω	typ	C
DISABLE (Disabled LOW)								
Power-Down Supply Current (+ V_S)	$V_{DIS} = 0$	-90				μ A	typ	C
Off Isolation	$F = 5.0MHz$	70				dB	typ	C
Output Capacitance in Disable		1.7				pF	typ	C
Turn On Glitch	$G = +2, R_L = 150\Omega, V_{IN} = V_S/2$					mV	typ	C
Turn Off Glitch	$G = +2, R_L = 150\Omega, V_{IN} = V_S/2$					mV	typ	C
Enable Voltage		3.4	3.5	3.6	3.7	V	min	A
Disable Voltage		1.8	1.7	1.6	1.5	V	max	A
Control Pin Input Bias Current (\overline{DIS})	$V_{DIS} = 0V$	80	120	130	135	μ A	max	A
POWER SUPPLY								
Specified Single-Supply Operating Voltage		5				V	typ	C
Max Single-Supply Operating Voltage Range			12	12	12	V	max	A
Min Single-Supply Operating Voltage Range		2.8				V	min	C
Max Quiescent Current	$V_S = +5V$	1.44	1.55	1.55	1.55	mA	max	A
Min Quiescent Current	$V_S = +5V$	1.44	1.30	1.20	1.15	mA	min	A
Power-Supply Rejection Ratio (+PSRR)	Input Referred	65				dB	typ	C
TEMPERATURE RANGE								
Specification: ID, IDBV		-40 to +85				$^{\circ}$ C	typ	C
Thermal Resistance, θ_{JA} Junction-to-Ambient								
D SO-8		125				$^{\circ}$ C/W	typ	C
DBV SOT23-6		150				$^{\circ}$ C/W	typ	C

NOTES: (1) Junction temperature = ambient for 25°C tested specifications. (2) Junction temperature = ambient at low temperature limit, junction temperature = ambient +1°C at high temperature limit for over temperature tested specifications. (3) Test levels: (A) 100% tested at 25°C. Over temperature limits by characterization and simulation. (B) Limits set by characterization and simulation. (C) Typical value only for information. (4) Current is considered positive out-of-node. V_{CM} is the input common-mode voltage. (5) Tested < 3dB below minimum specified CMR at \pm CMIR limits.

TYPICAL CHARACTERISTICS: $V_S = \pm 5V$

At $T_A = +25^\circ C$, $G = +2$, $R_F = 1k\Omega$, $R_L = 100\Omega$, unless otherwise noted.

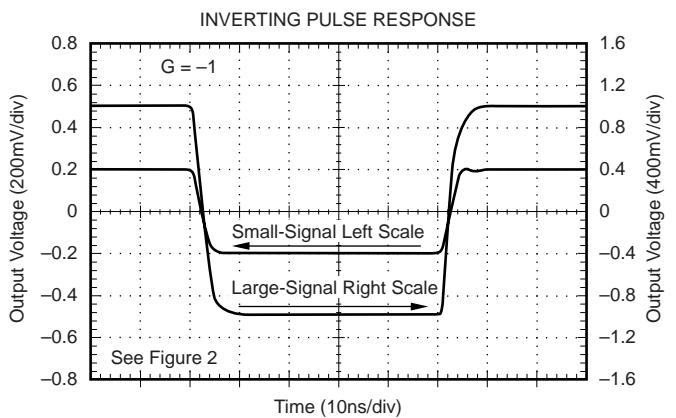
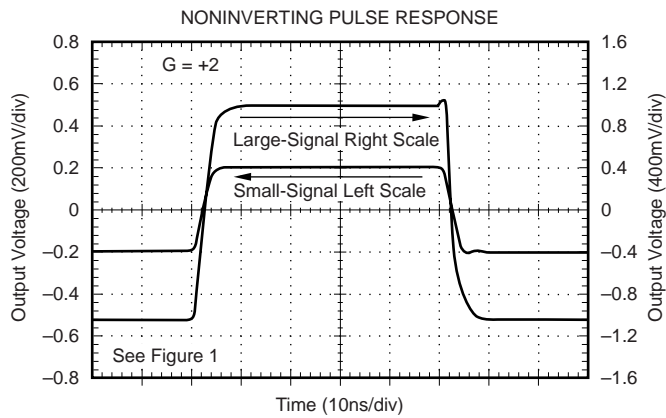
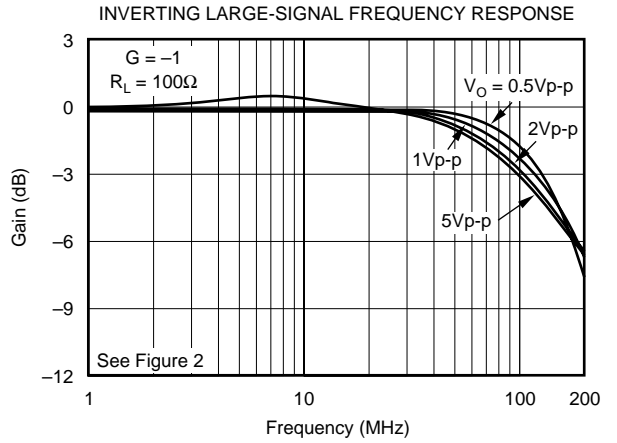
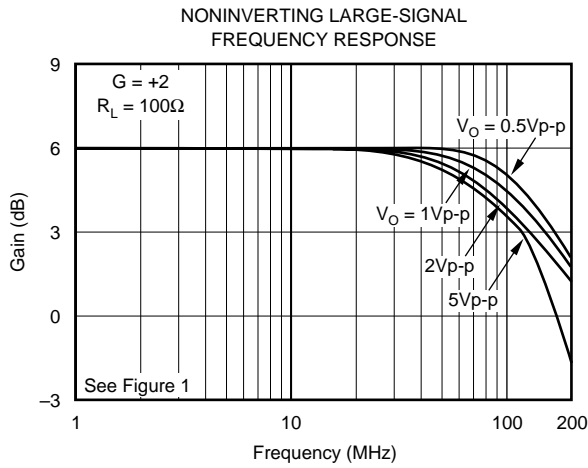
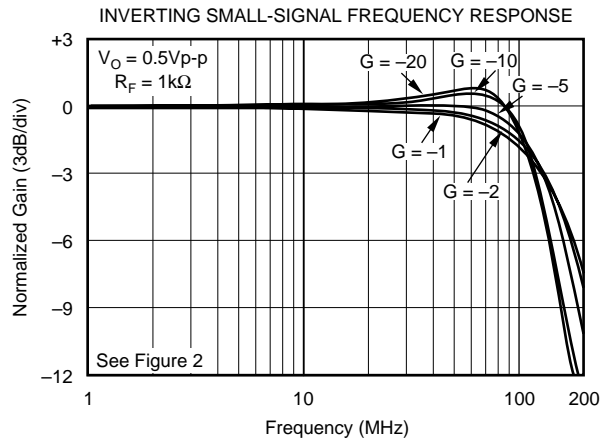
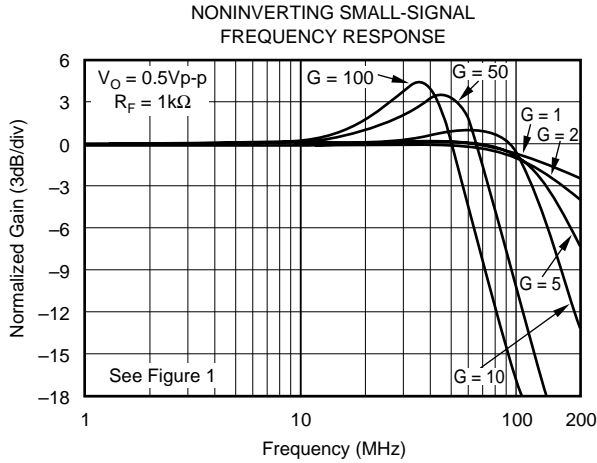

TYPICAL CHARACTERISTICS: $V_S = \pm 5V$ (Cont.)

At $T_A = +25^\circ C$, $G = +2$, $R_F = 1k\Omega$, $R_L = 100\Omega$, unless otherwise noted.

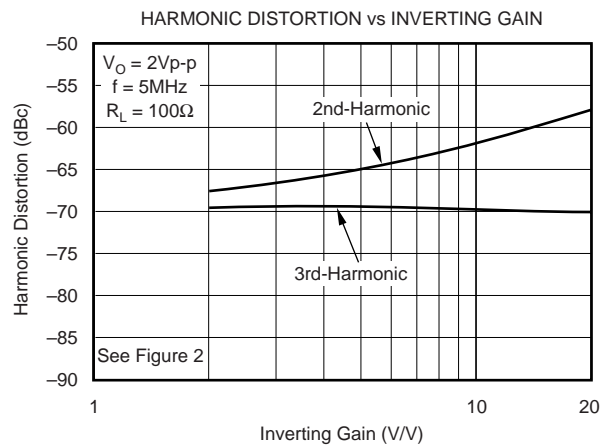
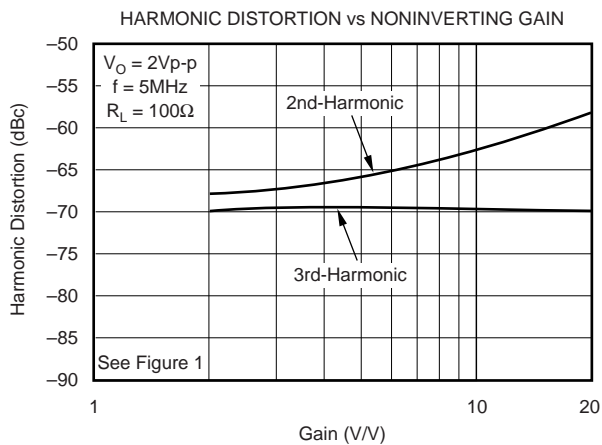
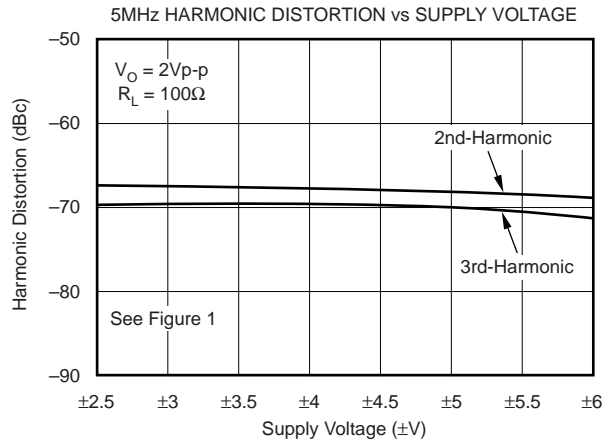
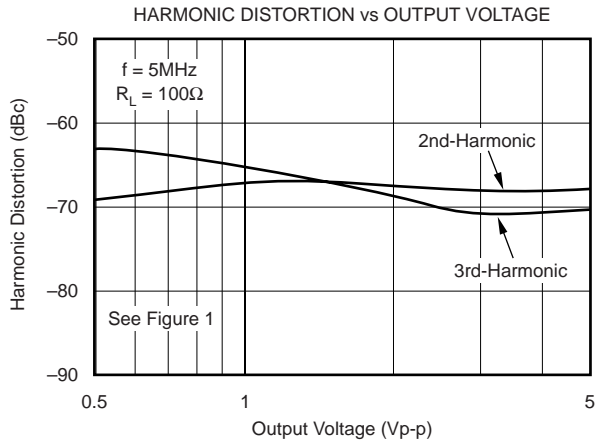
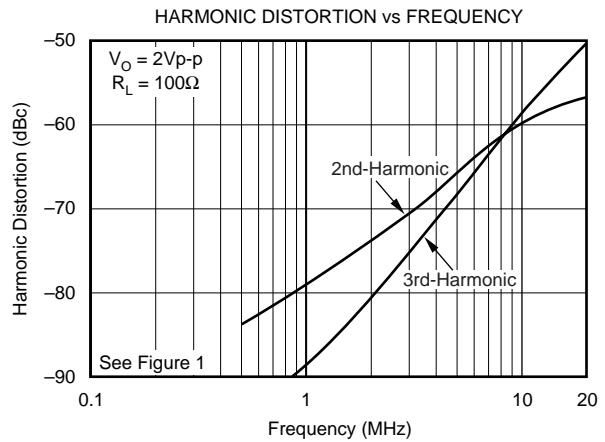
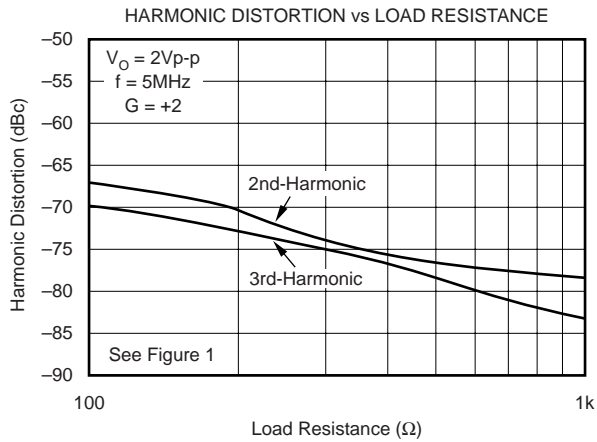

TYPICAL CHARACTERISTICS: $V_S = \pm 5V$ (Cont.)

At $T_A = +25^\circ C$, $G = +2$, $R_F = 1k\Omega$, $R_L = 100\Omega$, unless otherwise noted.

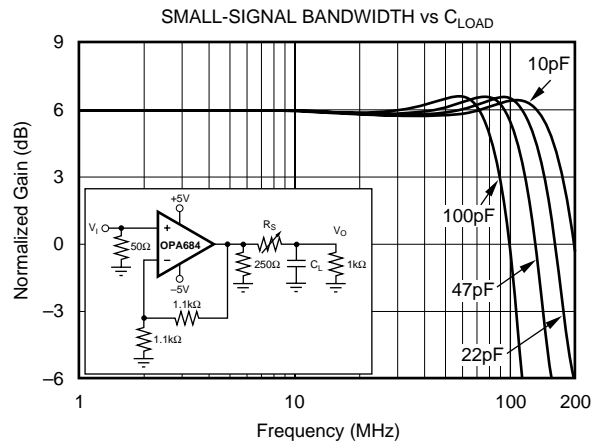
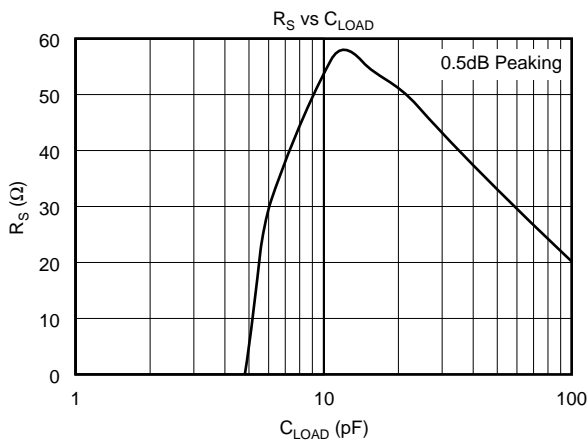
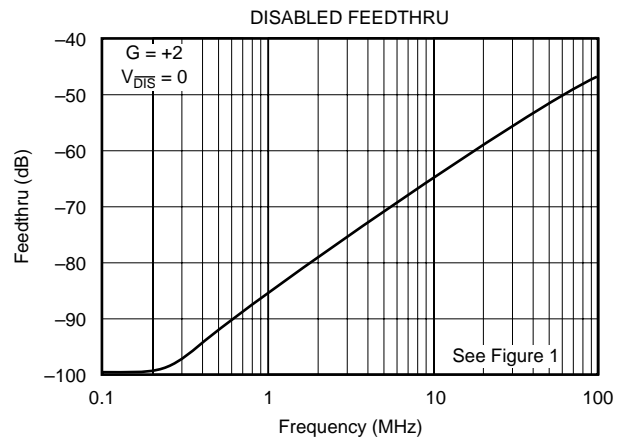
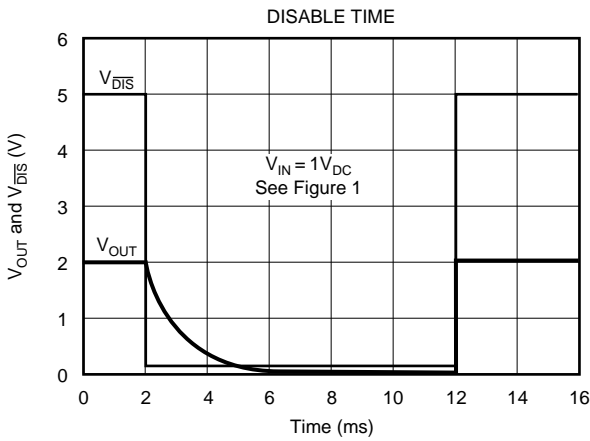
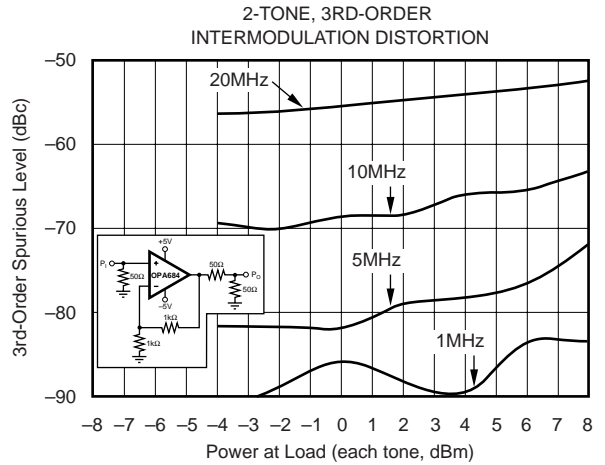
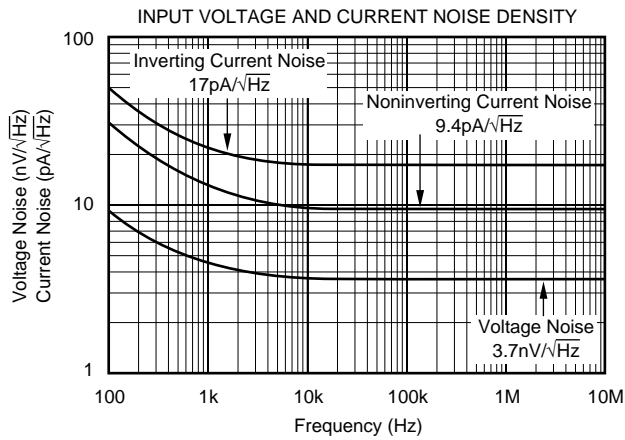

TYPICAL CHARACTERISTICS: $V_S = \pm 5V$ (Cont.)

At $T_A = +25^\circ C$, $G = +2$, $R_F = 1k\Omega$, $R_L = 100\Omega$, unless otherwise noted.

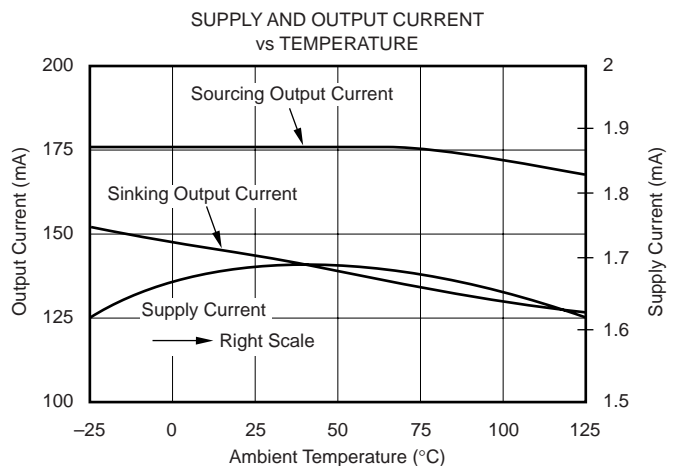
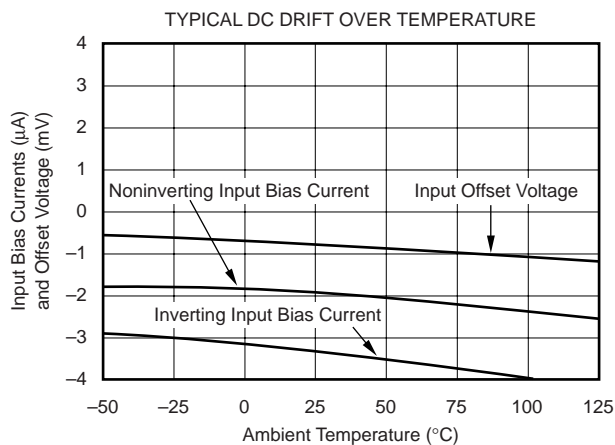
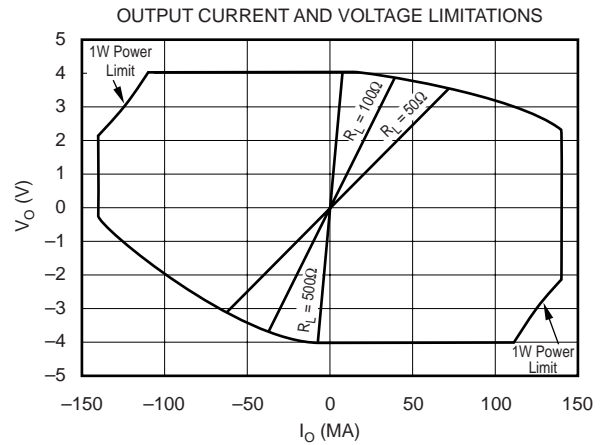
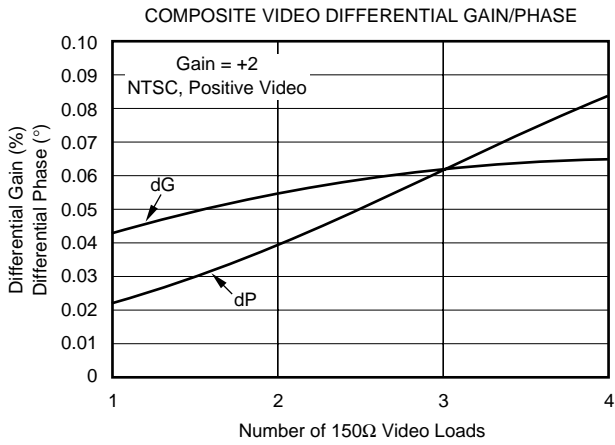
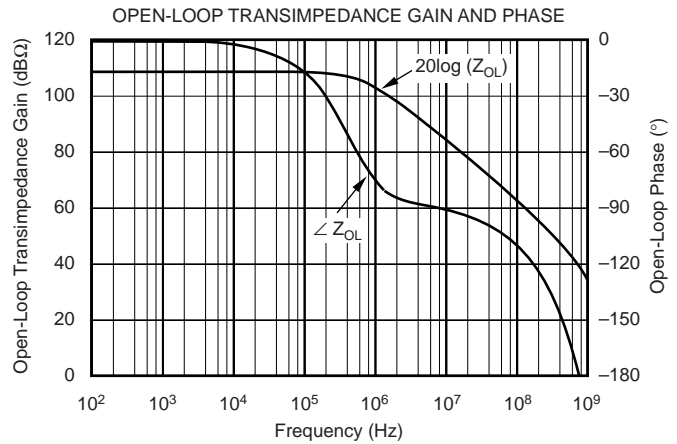
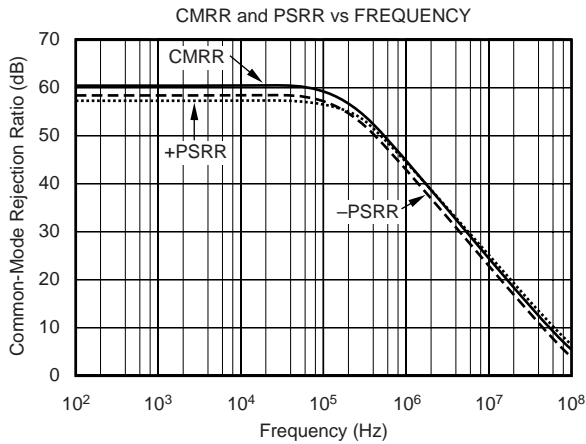

TYPICAL CHARACTERISTICS: $V_S = \pm 5V$ (Cont.)

At $T_A = +25^\circ C$, $G = +2$, $R_F = 1k\Omega$, $R_L = 100\Omega$, unless otherwise noted.

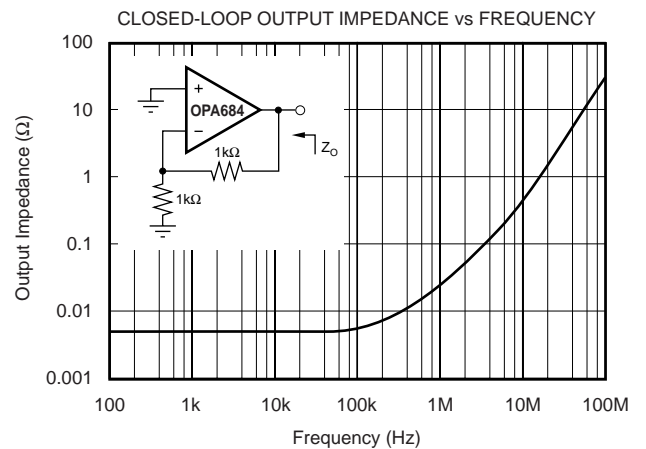
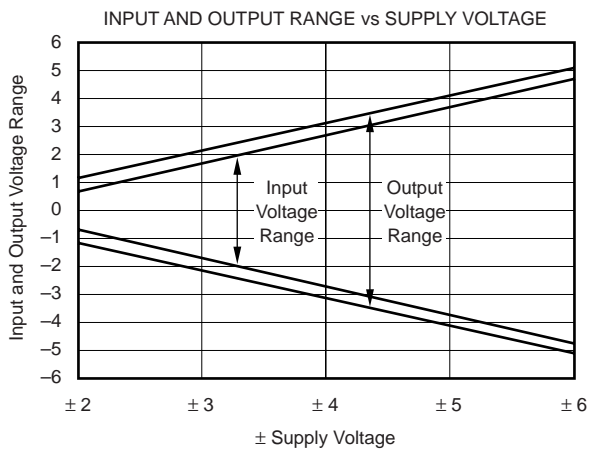
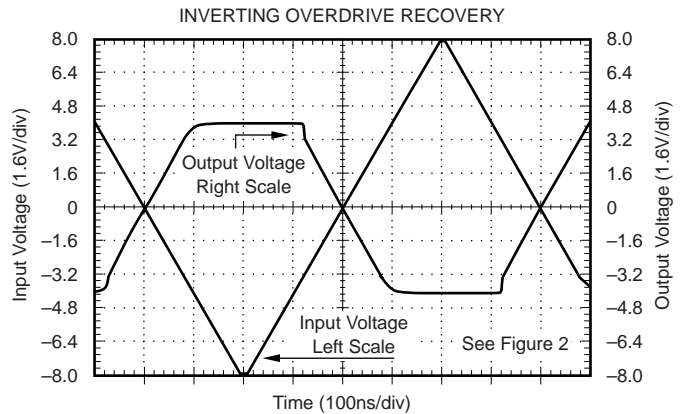
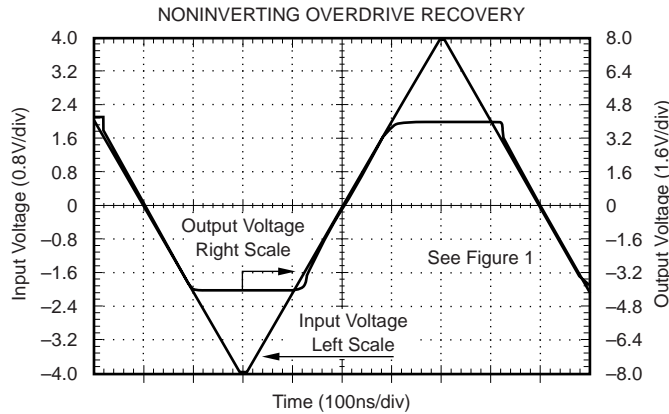
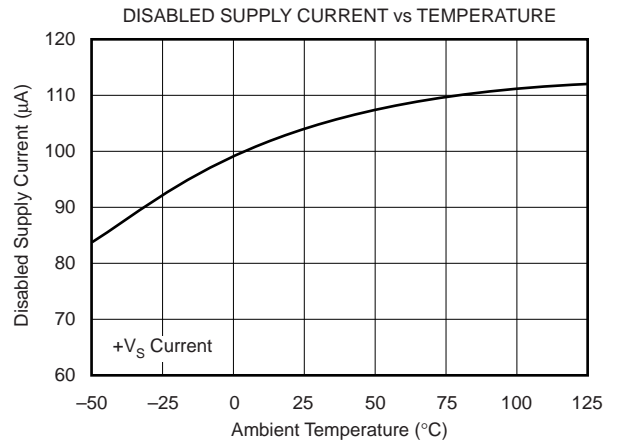
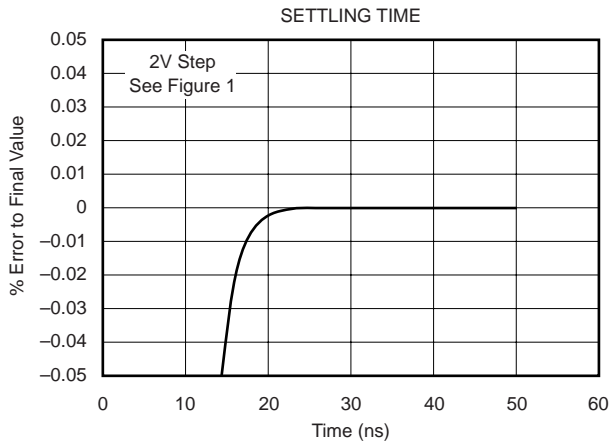

TYPICAL CHARACTERISTICS: $V_S = +5V$

At $T_A = +25^\circ C$, $V_S = 5V$, $G = +2$, $R_F = 1.3k\Omega$, $R_L = 100\Omega$, unless otherwise noted.

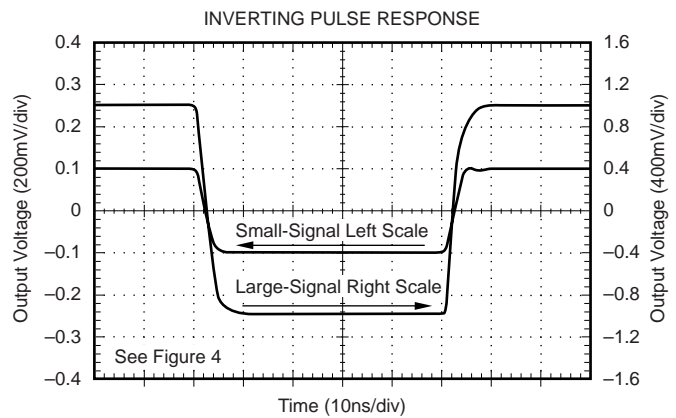
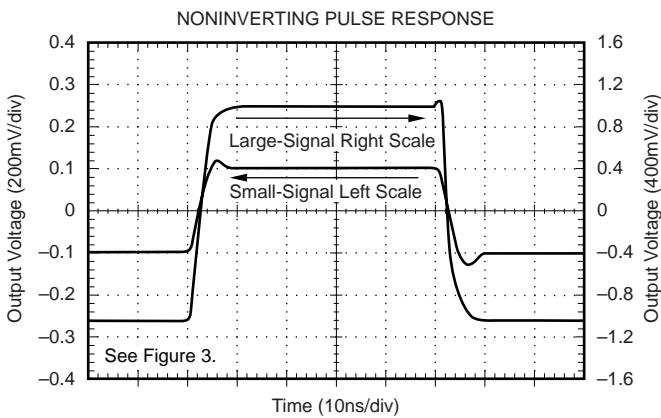
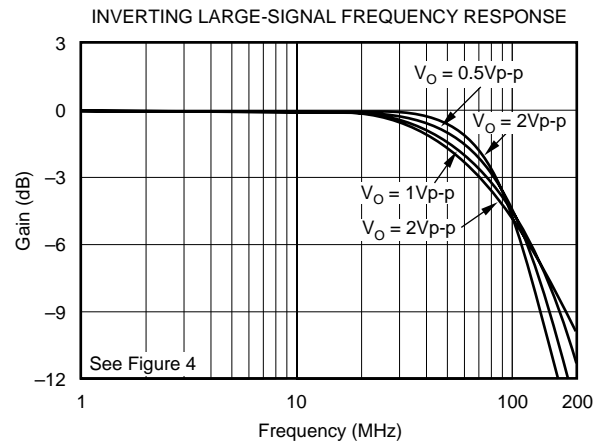
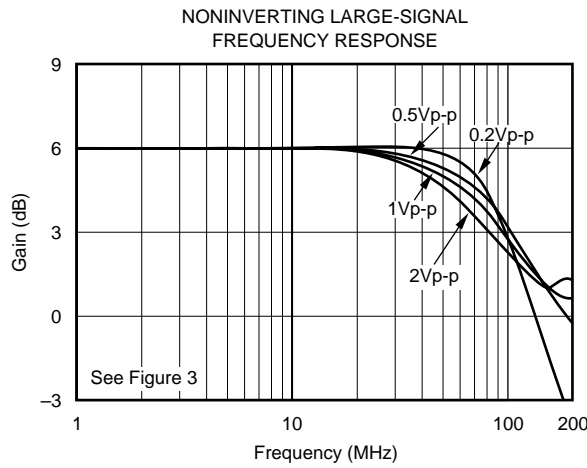
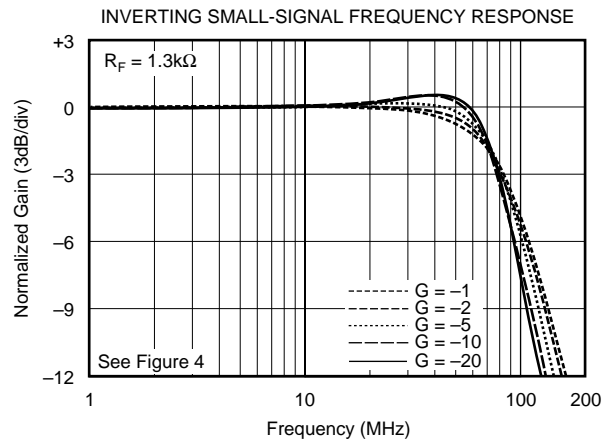
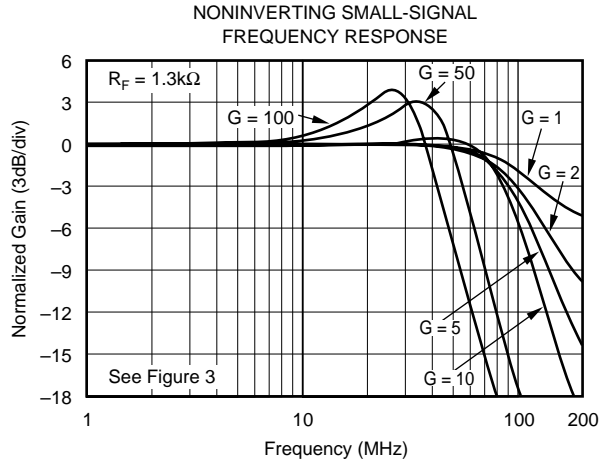

TYPICAL CHARACTERISTICS: $V_S = +5V$ (Cont.)

At $T_A = +25^\circ\text{C}$, $V_S = 5V$, $G = +2$, $R_F = 1.3k\Omega$, $R_L = 100\Omega$, unless otherwise noted.

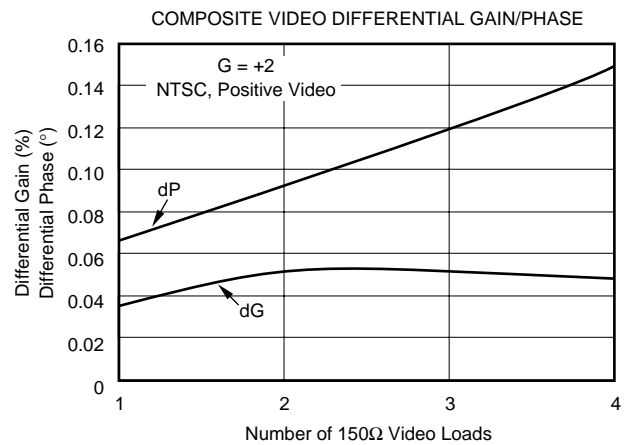
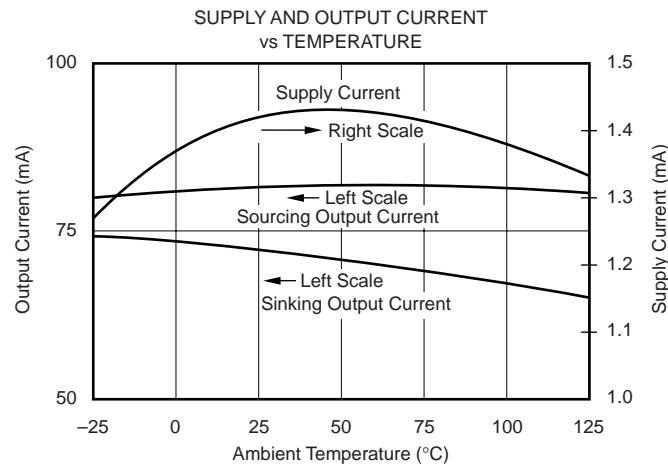
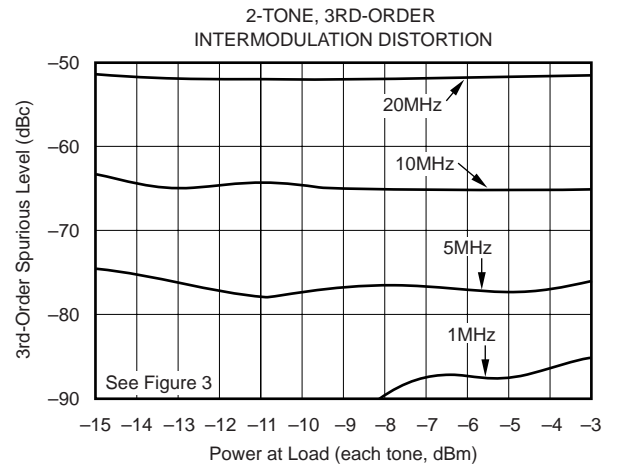
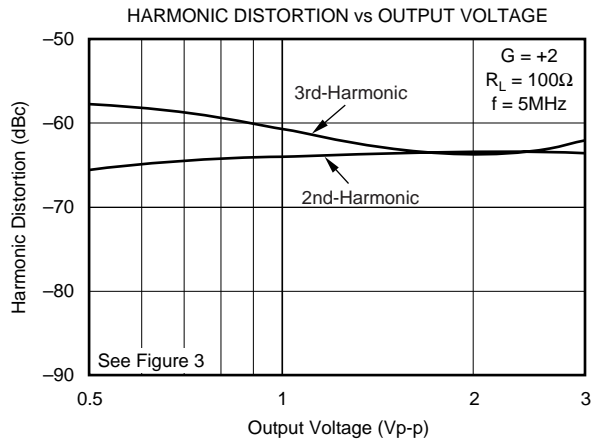
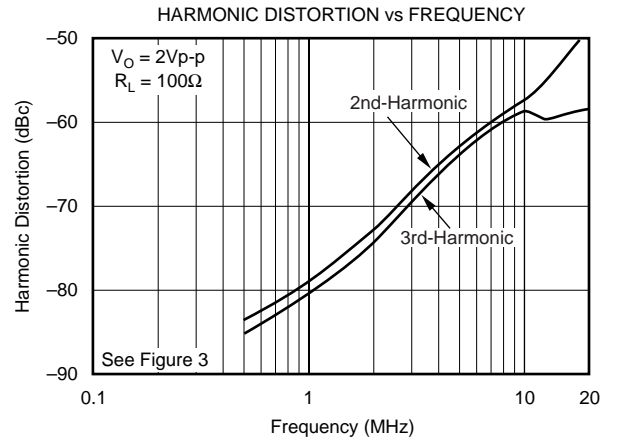
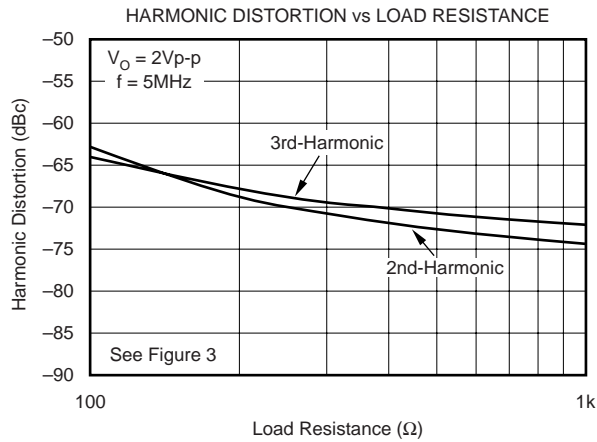

APPLICATIONS INFORMATION

LOW-POWER, CURRENT-FEEDBACK OPERATION

The OPA684 gives a new level of performance in low-power, current-feedback op amps. Using a new input stage buffer architecture, the OPA684 CFB_{plus} amplifier holds nearly constant AC performance over a wide gain range. This closed-loop internal buffer gives a very low and linearized impedance at the inverting node, isolating the amplifier's AC performance from gain element variations. This allows both the bandwidth and distortion to remain nearly constant over gain, moving closer to the ideal current feedback performance of gain bandwidth independence. This low power amplifier also delivers exceptional output power—its $\pm 4V$ swing on $\pm 5V$ supplies with $>100mA$ output drive gives excellent performance into standard video loads or doubly-terminated 50Ω cables. Single $+5V$ supply operation is also supported with similar bandwidths but with reduced output power capability. For lower quiescent power in a CFB_{plus} amplifier, consider the OPA683, while for higher output power, consider the OPA691.

Figure 1 shows the DC coupled, gain of $+2$, dual power-supply circuit used as the basis of the $\pm 5V$ Electrical and Typical Characteristics. For test purposes, the input impedance is set to 50Ω with a resistor to ground, and the output impedance is set to 50Ω with a series output resistor. Voltage swings reported in the characteristics are taken directly at the input and output pins while load powers (dBm) are defined at a matched 50Ω load. For the circuit of Figure 1, the total effective load will be $100\Omega \parallel 2000\Omega = 95\Omega$. Gain changes are most easily accomplished by simply resetting the R_G value, holding R_F constant at its recommended value of $1k\Omega$. The disable control line (\overline{DIS}) is typically left open to give normal amplifier operation. It may, however, be asserted LOW to reduce the amplifier supply current to $100\mu A$ typically.

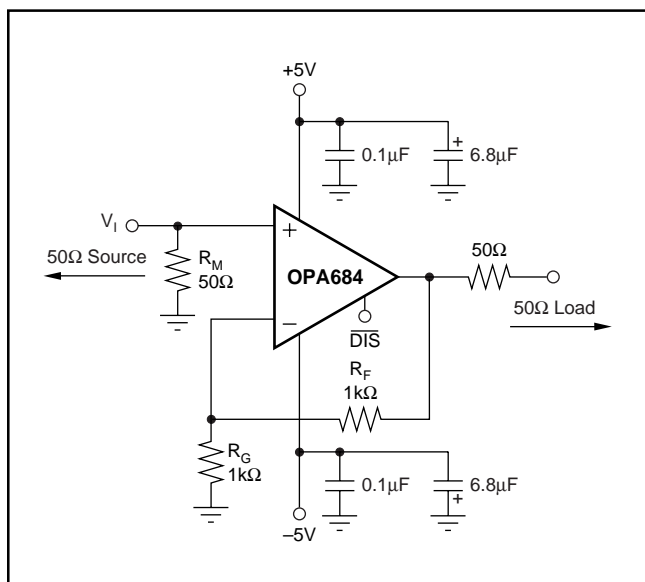

FIGURE 1. DC Coupled, $G = +2V/V$, Bipolar Supply Specifications and Test Circuit.

Figure 2 shows the DC coupled, gain of $-1V/V$, dual power-supply circuit used as the basis of the Inverting Typical Characteristics. Inverting operation offers several performance benefits. Since there is no common-mode signal across the input stage, the slew rate for inverting operation is higher and the distortion performance is slightly improved. An additional input resistor, R_M , is included in Figure 2 to set the input impedance equal to 50Ω . The parallel combination of R_M and R_G set the input impedance. As the desired gain increases for the inverting configuration, R_G is adjusted to achieve the desired gain, while R_M is also adjusted to hold a 50Ω input match. A point will be reached where R_G will equal 50Ω , R_M is removed, and the input match is set by R_G only. With R_G fixed to achieve an input match to 50Ω , increasing R_F will increase the gain. This will, however, quickly reduce the achievable bandwidth as the feedback resistor increases from its recommended value of $1k\Omega$. If the source does not require an input match of 50Ω , either adjust R_M to get the desired load, or remove it and let the R_G resistor alone provide the input load.

These circuits show $\pm 5V$ operation. The same circuits can be applied with bipolar supplies from $\pm 2.5V$ to $\pm 6V$. Internal supply independent biasing gives nearly the same performance for the OPA684 over this wide range of supplies. Generally, the optimum feedback resistor value (for nominally flat frequency response at $G = +2$) will increase in value as the total supply voltage across the OPA684 is reduced.

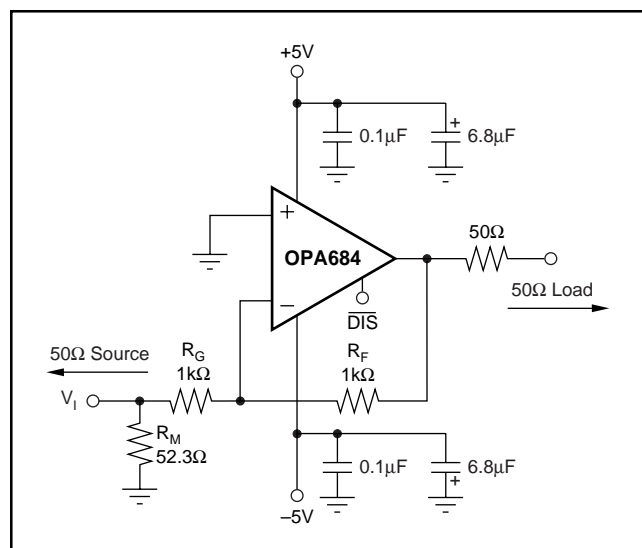

FIGURE 2. DC Coupled, $G = -1V/V$, Bipolar Supply, Specification and Test Circuit.

Figure 3 shows the AC-coupled, single $+5V$ supply, gain of $+2V/V$ circuit configuration used as a basis only for the $+5V$ Electrical and Typical Characteristics. The key requirement of broadband single-supply operation is to maintain input and output signal swings within the usable voltage ranges at both the input and the output. The circuit of Figure 3 establishes an input midpoint bias using a simple resistive divider from the $+5V$ supply (two $10k\Omega$ resistors) to the non-inverting input. The input signal is then AC coupled into this midpoint

INVERTING SUMMING APPLICATIONS

The OPA684 provides one of the most robust summing operations available in a wideband op amp. Figure 6 shows a typical inverting summing application where, in this case, 4 sources are summed through 500Ω gain resistors while also including an 88.9Ω terminating impedance to present a 75Ω input impedance to each source. The gain for each channel is -2 to the output pin and -1 to the matched load. The extremely low inverting input impedance of the CFB_{plus} architectures ensures noninteractive summing for all of the channels. The amplifier bandwidth is largely independent of variations in the gain setting elements, depending primarily on the feedback resistor value instead. This type of circuit may be used to sum numerous signals together or, where the prior stages can be disabled, allow multiple channels to be brought together with only the active channel passing on to the output.

SAW FILTER POST-AMPLIFIER

While SAW filters provide unmatched selectivity in a passive filter element, this comes at the cost of significant insertion loss for the desired signal. The OPA684 can provide a low-cost and low-power post-amplifier over a wide range of gains due to the CFB_{plus} internal architecture. Figure 7 shows a 44MHz SAW filter with 20dB insertion loss followed by an OPA684 operating at a gain of 20V/V (26dB) providing a net gain of 1 (0dB) from the input of the SAW filter to a matched 50Ω load. The circuit shown also includes a simple bandpass around 44MHz to reduce out-of-band noise. The gain for the circuit of Figure 7 ranges from 0dB at DC to 28dB at 44MHz and then back to < 0 dB above 200MHz. The LC elements in the gain circuit peak the response slightly above a gain of 26dB—removing those would give a broadband gain of 26dB.

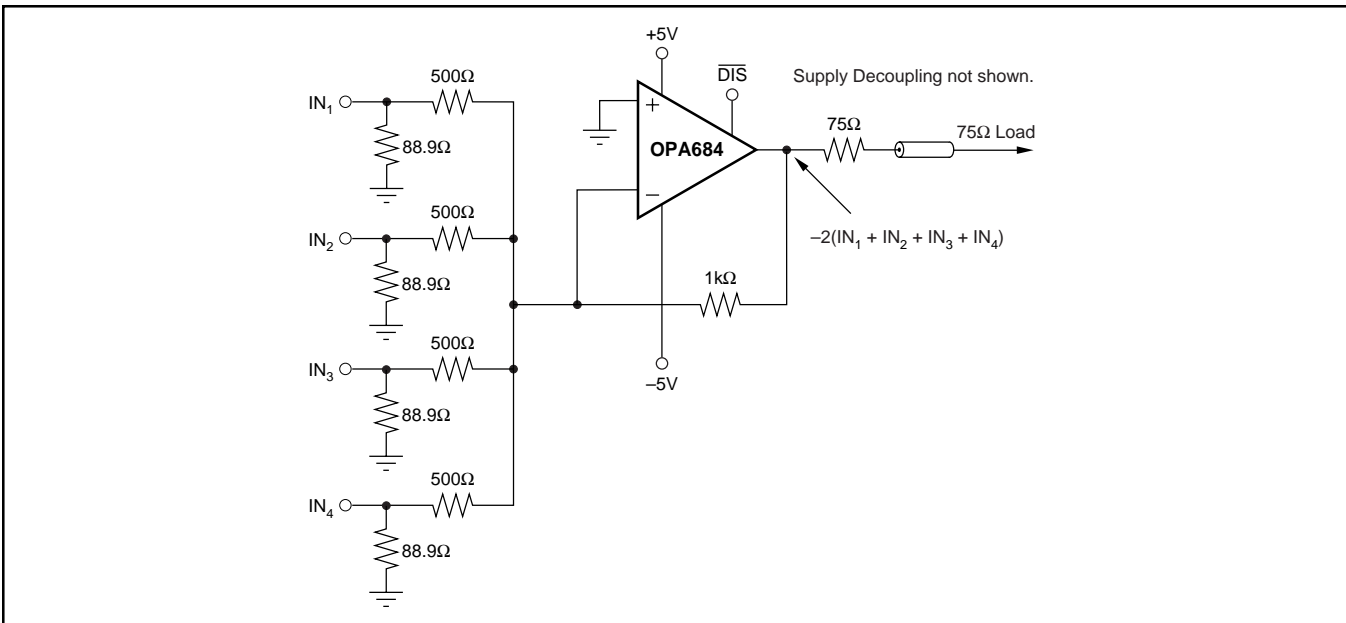

FIGURE 6. Gain of -2 Video Summing Amplifier.

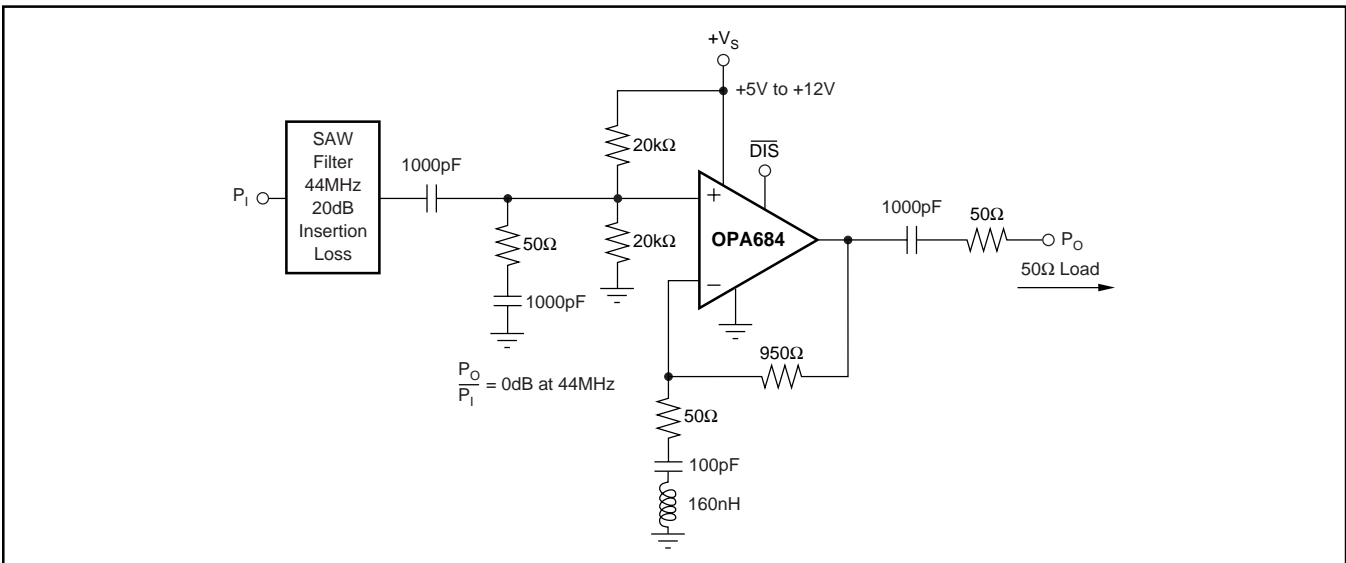

FIGURE 7. Single-Supply, High-Gain SAW Post-Amplifier.

Figure 8 shows the small-signal frequency response for the amplifier portion of this circuit, from the non-inverting input to the output pin. This particular example is configured as a single-supply circuit that will operate over a supply range from +5V to +12V. Where higher frequencies or 3rd-order intercepts are required, consider the OPA685, a very high bandwidth (> 500MHz) current-feedback op amp.

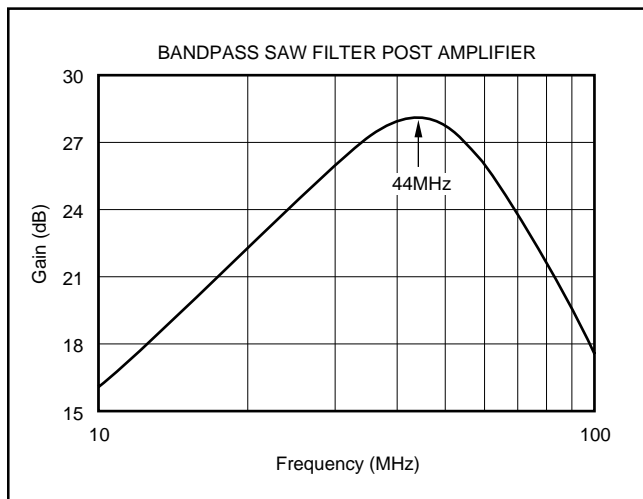

FIGURE 8. Bandpass SAW Filter Post-Amplifier.

LOW POWER, ADC DRIVER

Where a low-power, single-supply, interface to a single-ended input +5V ADC is required, the circuit of Figure 9 can provide a very flexible, higher performance solution. Running in an AC-coupled inverting mode allows the non-inverting input to be used for the CM (Common-Mode) voltage from the ADS825 converter. This midpoint reference biases both

the non-inverting converter input and the amplifier non-inverting input. With an AC-coupled gain path, this +2.5V has a gain of +1 to the output, putting the output at the DC midpoint for the converter. The output then drives through an isolating resistor (50Ω) to the inverting input of the converter, which is further de-coupled by a 10pF external capacitance to add to its 5pF input capacitance. This coupling network provides a high frequency cutoff, while also giving a low source impedance at high frequencies for the converter. The gain for this circuit is set by adjusting R_G to the desired value. For a 2V_{pp} maximum output driving the light load of Figure 9, the OPA684 will provide > 75dB SFDR through 5MHz (see the Typical Characteristics).

DESIGN-IN TOOLS

DEMONSTRATION FIXTURES

Two printed circuit boards (PCBs) are available to assist in the initial evaluation of circuit performance using the OPA684 in its two package options. Both of these are offered free of charge as unpopulated PCBs, delivered with a user's guide. The summary information for these fixtures is shown in Table I.

PRODUCT	PACKAGE	ORDERING NUMBER	LITERATURE NUMBER
OPA684ID	SO-8	DEM-OPA-SO-1A	SBOU009
OPA684IDBQ	SOT23-6	DEM-OPA-SOT-1A	SBOU010

TABLE I. Demonstration Fixtures by Package.

The demonstration fixtures can be requested at the Texas Instruments web site (www.ti.com) through the OPA684 product folder.

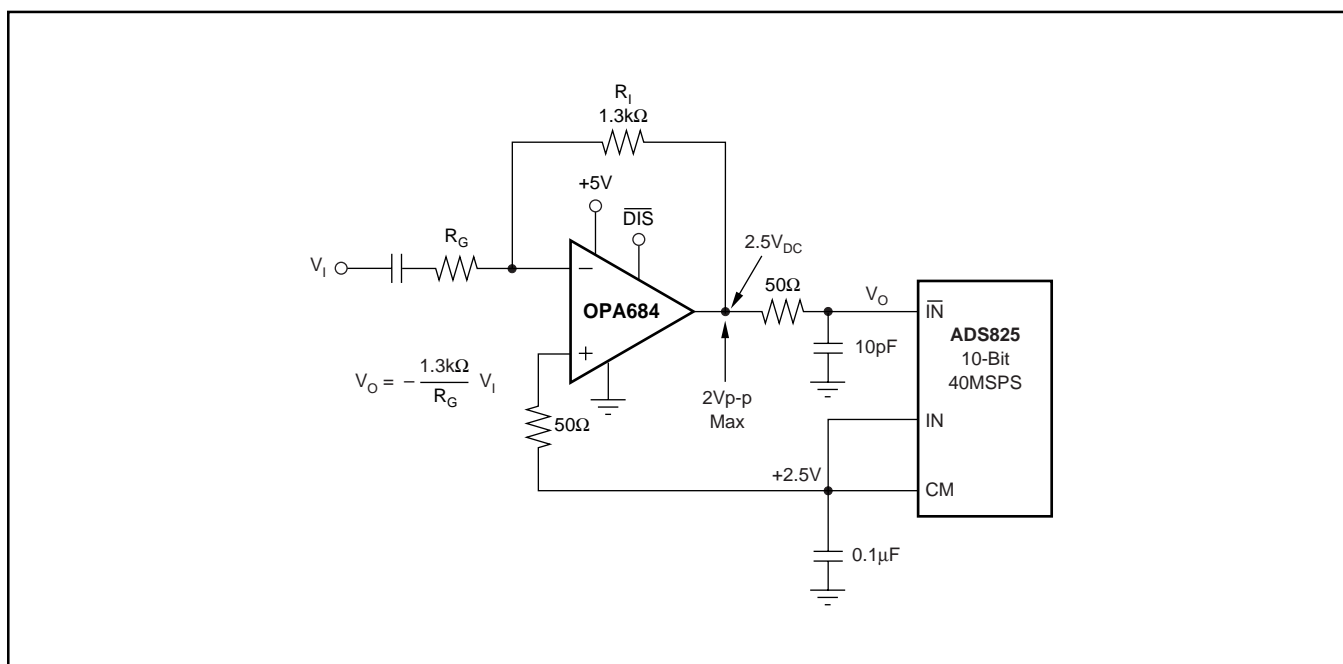

FIGURE 9. Low-Power, Single-Supply, ADC Driver.

OPERATING SUGGESTIONS

SETTING RESISTOR VALUES TO OPTIMIZE BANDWIDTH

Any current-feedback op amp like the OPA684 can hold high bandwidth over signal-gain settings with the proper adjustment of the external resistor values. A low-power part like the OPA684 typically shows a larger change in bandwidth due to the significant contribution of the inverting input impedance to loop-gain changes as the signal gain is changed. Figure 10 shows a simplified analysis circuit for any current-feedback amplifier.

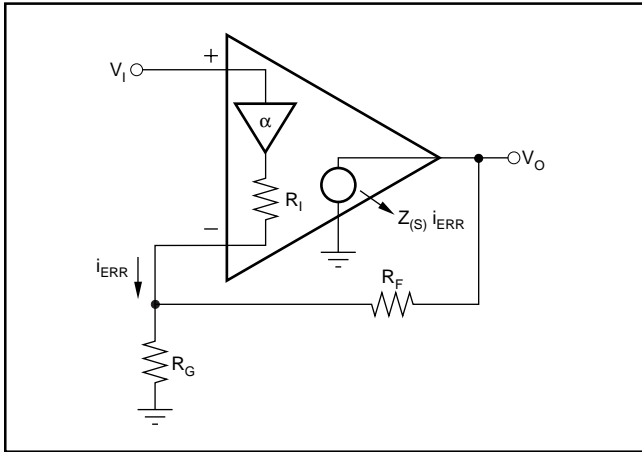

FIGURE 10. Current Feedback Transfer Function Analysis Circuit.

The key elements of this current-feedback op amp model are:

$\alpha \Rightarrow$ Buffer gain from the non-inverting input to the inverting input.

$R_I \Rightarrow$ Buffer output impedance.

$i_{ERR} \Rightarrow$ Feedback error current signal.

$Z_{(s)} \Rightarrow$ Frequency dependent open loop transimpedance gain from i_{ERR} to V_O .

The buffer gain is typically very close to 1.00 and is normally neglected from signal gain considerations. It will, however, set the CMRR for a single op amp differential amplifier configuration. For the buffer gain $\alpha < 1.0$, the CMRR = $-20 \cdot \log(1 - \alpha)$. The closed-loop input stage buffer used in the OPA684 gives a buffer gain more closely approaching 1.00 and this shows up in a slightly higher CMRR than any previous current feedback op amp.

R_I , the buffer output impedance, is a critical portion of the bandwidth control equation. The OPA684 reduces this element to approximately 2.5Ω , using the loop gain of the local input buffer stage. This significant reduction in output impedance, on very low power, contributes significantly to extending the bandwidth at higher gains.

A current-feedback op amp senses an error current in the inverting node (as opposed to a differential input error voltage for a voltage-feedback op amp) and passes this on to the output through an internal frequency dependent transimpedance gain. The Typical Characteristics show this open-loop transimpedance response. This is analogous to

the open-loop voltage gain curve for a voltage-feedback op amp. Developing the transfer function for the circuit of Figure 10 gives Equation 1:

$$\frac{V_O}{V_I} = \frac{\alpha \left(1 + \frac{R_F}{R_G} \right)}{R_F + R_I \left(1 + \frac{R_F}{R_G} \right) + \frac{Z_{(s)}}{1 + \frac{R_F}{R_G}}} = \frac{\alpha NG}{1 + \frac{R_F + R_I NG}{Z_{(s)}}} \quad (1)$$

$$\left[NG = \left(1 + \frac{R_F}{R_G} \right) \right]$$

This is written in a loop-gain analysis format where the errors arising from a non-infinite open-loop gain are shown in the denominator. If $Z_{(s)}$ were infinite over all frequencies, the denominator of Equation 1 would reduce to 1 and the ideal desired signal gain shown in the numerator would be achieved. The fraction in the denominator of Equation 1 determines the frequency response. Equation 2 shows this as the loop-gain equation.

$$\frac{Z_{(s)}}{R_F + R_I NG} = \text{Loop Gain} \quad (2)$$

If $20 \cdot \log(R_F + NG \cdot R_I)$ were drawn on top of the open-loop transimpedance plot, the difference between the two would be the loop gain at a given frequency. Eventually, $Z_{(s)}$ rolls off to equal the denominator of Equation 2, at which point the loop gain has reduced to 1 (and the curves have intersected). This point of equality is where the amplifier's closed-loop frequency response given by Equation 1 will start to roll off, and is exactly analogous to the frequency at which the noise gain equals the open-loop voltage gain for a voltage-feedback op amp. The difference here is that the total impedance in the denominator of Equation 2 may be controlled separately from the desired signal gain (or NG).

The OPA684 is internally compensated to give a maximally flat frequency response for $R_F = 1k\Omega$ at $NG = 2$ on $\pm 5V$ supplies. That optimum value goes to $1.3k\Omega$ on a single $+5V$ supply. Normally, with a current-feedback amplifier, it is possible to adjust the feedback resistor to hold this bandwidth up as the gain is increased. The CFB_{plus} architecture has reduced the contribution of the inverting input impedance to provide exceptional bandwidth to higher gains without adjusting the feedback resistor value. The Typical Characteristics show the small-signal bandwidth over gain with a fixed feedback resistor.

At very high gains, 2nd-order effects in the inverting output impedance cause the overall response to peak up. If desired, it is possible to retain a flat frequency response at higher gains by adjusting the feedback resistor to higher values as the gain is increased. See Figure 11 for the empirically determined feedback resistor and resulting $-3dB$ bandwidth from gains of $+2$ to $+100$ to hold a $< 0.5dB$ peaked response. See Figure 12 for the measured frequency response curves with the adjusted feedback resistor value. While the bandwidth for this low-power part does reduce at higher gains,

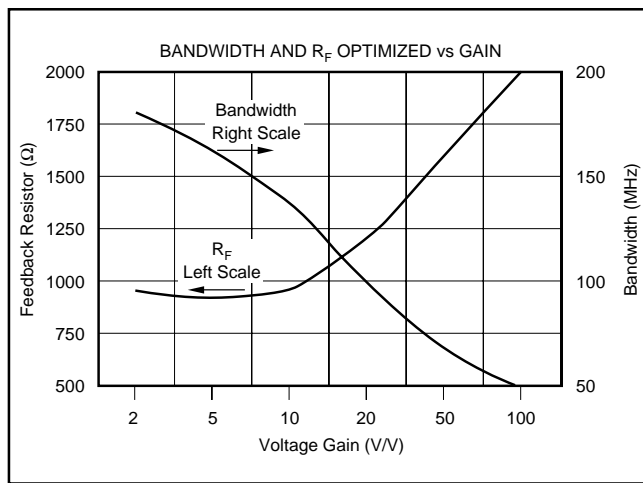

FIGURE 11. Bandwidth and R_F Optimized vs Gain.

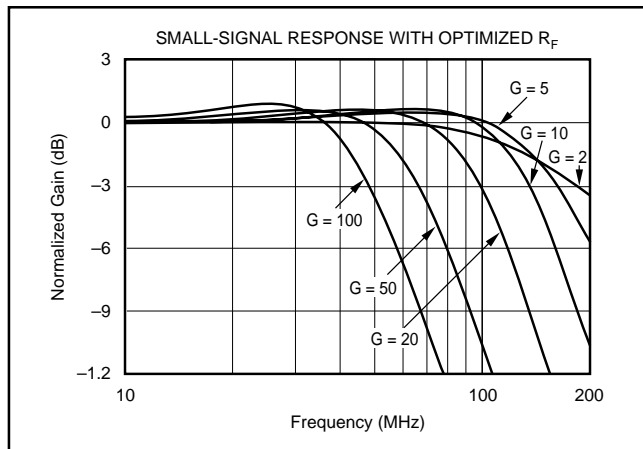

FIGURE 12. Small-Signal Frequency Response with Optimized R_F .

going over a 50:1 gain range gives only a factor of 3.5 bandwidth reduction. The 50MHz bandwidth at a gain of 100V/V is equivalent to a 5GHz gain-bandwidth product voltage-feedback amplifier capability.

OUTPUT CURRENT AND VOLTAGE

The OPA684 provides output voltage and current capabilities that can support the needs of driving doubly-terminated 50 Ω lines. For a 100 Ω load at the gain of +2, (see Figure 1), the total load is the parallel combination of the 100 Ω load and the 2k Ω total feedback network impedance. This 95 Ω load will require no more than 40mA output current to support the $\pm 3.8V$ minimum output voltage swing for 100 Ω loads. This is well under the specified minimum +130/-100mA specifications over the full temperature range.

The specifications described above, though familiar in the industry, consider voltage and current limits separately. In many applications, it is the voltage • current, or V-I product, which is more relevant to circuit operation. Refer to the *Output Current and Voltage Limitations* curve in the Typical Characteristics. The X and Y axes of this graph show the zero-voltage output current limit and the zero-current output voltage limit, respectively. The four quadrants give a more

detailed view of the OPA684's output drive capabilities. Superimposing resistor load lines onto the plot shows the available output voltage and current for specific loads.

The minimum specified output voltage and current over temperature are set by worst-case simulations at the cold temperature extreme. Only at cold startup will the output current and voltage decrease to the numbers shown in the Electrical Characteristic tables. As the output transistors deliver power, their junction temperatures will increase, decreasing their V_{BEs} (increasing the available output voltage swing) and increasing their current gains (increasing the available output current). In steady-state operation, the available output voltage and current will always be greater than that shown in the over-temperature specifications since the output stage junction temperatures will be higher than the minimum specified operating ambient.

To maintain maximum output stage linearity, no output short-circuit protection is provided. Normally, this will not be a problem since most applications include a series-matching resistor at the output that will limit the internal power dissipation if the output side of this resistor is shorted to ground. However, shorting the output pin directly to the adjacent positive power-supply pin (8-pin packages) will, in most cases, destroy the amplifier. If additional short-circuit protection is required, consider a small-series resistor in the power-supply leads. This will, under heavy output loads, reduce the available output voltage swing. A 5 Ω series resistor in each power-supply lead will limit the internal power dissipation to less than 1W for an output short-circuit, while decreasing the available output voltage swing only 0.25V for up to 50mA desired load currents. Always place the 0.1 μF power-supply decoupling capacitors after these supply current limiting resistors directly on the supply pins.

DRIVING CAPACITIVE LOADS

One of the most demanding and yet very common load conditions for an op amp is capacitive loading. Often, the capacitive load is the input of an Analog-to-Digital Converter (ADC), including additional external capacitance which may be recommended to improve ADC linearity. A high-speed, high open-loop gain, amplifier like the OPA684 can be very susceptible to decreased stability and closed-loop response peaking when a capacitive load is placed directly on the output pin. When the amplifier's open-loop output resistance is considered, this capacitive load introduces an additional pole in the signal path that can decrease the phase margin. Several external solutions to this problem have been suggested. When the primary considerations are frequency response flatness, pulse response fidelity, and/or distortion, the simplest and most effective solution is to isolate the capacitive load from the feedback loop by inserting a series isolation resistor between the amplifier output and the capacitive load. This does not eliminate the pole from the loop response, but rather shifts it and adds a zero at a higher frequency. The additional zero acts to cancel the phase lag from the capacitive load pole, thus increasing the phase margin and improving stability.

The Typical Characteristics show the recommended R_S vs C_{LOAD} and the resulting frequency response at the load. To reduce the required value of R_S , those curves show a slight increase in the feedback resistor value and an added load of 250Ω to ground. The $1k\Omega$ resistor shown in parallel with the load capacitor is a measurement path and may be omitted. Parasitic capacitive loads greater than $5pF$ can begin to degrade the performance of the OPA684. Long PC board traces, unmatched cables, and connections to multiple devices can easily cause this value to be exceeded. Always consider this effect carefully, and add the recommended series resistor as close as possible to the OPA684 output pin (see Board Layout Guidelines).

DISTORTION PERFORMANCE

The OPA684 provides very low distortion in a low-power part. The CFB_{plus} architecture also gives two significant areas of distortion improvement. First, in operating regions where the 2nd-harmonic distortion due to output stage nonlinearities is very low (frequencies $< 1MHz$, low output swings into light loads), the linearization at the inverting node provided by the CFB_{plus} design gives 2nd-harmonic distortions that extend into the $-90dBc$ region. Previous current-feedback amplifiers have been limited to approximately $-85dBc$ due to the nonlinearities at the inverting input. The 2nd-area of distortion improvement comes in a distortion performance that is largely gain independent. To the extent that the distortion at a particular output power is output stage dependent, 3rd-harmonics particularly, and to a lesser extent 2nd-harmonic distortion, are constant as the gain is increased. This is due to the constant loop gain versus signal gain provided by the CFB_{plus} design. As shown in the Typical Characteristics, while the 3rd-harmonic is constant with gain, the 2nd-harmonic degrades at higher gains. This is largely due to board parasitic issues. Slightly imbalanced load return currents will couple into the gain resistor to cause a portion of the 2nd-harmonic distortion. At high gains, this imbalance has more gain to the output giving increased 2nd-harmonic distortion.

Relative to alternative amplifiers with $< 2mA$ supply current, the OPA684 holds much lower distortion at higher frequencies ($> 5MHz$) and to higher gains. Generally, until the fundamental signal reaches very high frequency or power levels, the 2nd-harmonic will dominate the distortion with a lower 3rd-harmonic component. Focusing then on the 2nd harmonic, increasing the load impedance improves distortion directly. Remember that the total load includes the feedback network—in the non-inverting configuration (see Figure 1) this is the sum of $R_F + R_G$, while in the inverting configuration it is just R_F . Also, providing an additional supply decoupling capacitor ($0.1\mu F$) between the supply pins (for bipolar operation) improves the 2nd-order distortion slightly (3dB to 6dB).

In most op amps, increasing the output voltage swing increases harmonic distortion directly. A low-power part like the OPA684 includes quiescent boost circuits to provide the full-power bandwidth shown in the Typical Characteristics. These act to increase the bias in a very linear fashion only when high slew rate or output power are required. This also acts to actually reduce the distortion slightly at higher output

power levels. The Typical Characteristics show the 2nd-harmonic holding constant from $500mV_{PP}$ to $5V_{PP}$ outputs, while the 3rd harmonics actually decrease with increasing output power.

The OPA684 has an extremely low 3rd-order harmonic distortion, particularly for light loads and at lower frequencies. This also gives low 2-tone 3rd-order intermodulation distortion, as shown in the Typical Characteristics. Since the OPA684 includes internal power boost circuits to retain good full-power performance at high frequencies and outputs, it does not show a classical 2-tone, 3rd-order intermodulation intercept characteristic. Instead, it holds relatively low and constant 3rd-order intermodulation spurious levels over power. The Typical Characteristics show this spurious level as a dBc below the carrier at fixed center frequencies swept over single-tone power at a matched 50Ω load. These spurious levels drop significantly ($> 12dB$) for lighter loads than the 100Ω used in the 2-tone 3rd-order intermodulation plot. Converter inputs for instance will see $< -82dBc$ 3rd-order spurious to $10MHz$ for full-scale inputs. For even lower 3rd-order intermodulation distortion to much higher frequencies, consider the OPA685.

NOISE PERFORMANCE

Wideband current-feedback op amps generally have a higher output noise than comparable voltage-feedback op amps. The OPA684 offers an excellent balance between voltage and current noise terms to achieve low output noise in a low power amplifier. The inverting current noise ($17pA/\sqrt{Hz}$) is lower than most other current-feedback op amps, while the input voltage noise ($3.7nV/\sqrt{Hz}$) is lower than any unity-gain stable, comparable slew rate, voltage-feedback op amp. This low input voltage noise was achieved at the price of higher non-inverting input current noise ($9.4pA/\sqrt{Hz}$). As long as the AC source impedance looking out of the non-inverting node is less than 200Ω , this current noise will not contribute significantly to the total output noise. The op amp input voltage noise and the two input current noise terms combine to give low output noise under a wide variety of operating conditions. Figure 13 shows the op amp noise analysis model with all the noise terms included. In this model, all noise terms are taken to be noise voltage or current density terms in either nV/\sqrt{Hz} or pA/\sqrt{Hz} .

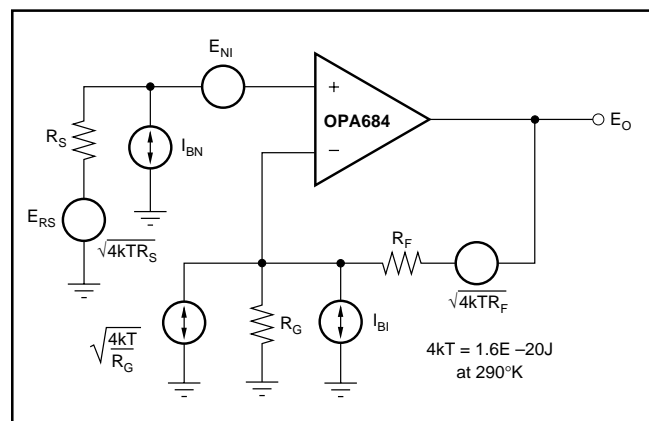

FIGURE 13. Op Amp Noise Analysis Model.

The total output spot noise voltage can be computed as the square root of the sum of all squared output noise voltage contributors. Equation 3 shows the general form for the output noise voltage using the terms shown in Figure 13.

(3)

$$E_O = \sqrt{\left(E_{NI}^2 + (I_{BN}R_S)^2 + 4kTR_S\right)G_N^2 + (I_{BI}R_F)^2 + 4kTR_F G_N}$$

Dividing this expression by the noise gain ($G_N = (1 + R_F/R_G)$) will give the equivalent input referred spot noise voltage at the non-inverting input, as shown in Equation 4.

(4)

$$E_{NI} = \sqrt{E_{NI}^2 + (I_{BN}R_S)^2 + 4kTR_S + \left(\frac{I_{BI}R_F}{G_N}\right)^2 + \frac{4kTR_F}{G_N}}$$

Evaluating these two equations for the OPA684 circuit and component values (see Figure 1) will give a total output spot noise voltage of $13.3nV/\sqrt{Hz}$ and a total equivalent input spot noise voltage of $6.7nV/\sqrt{Hz}$. This total input referred spot noise voltage is higher than the $3.7nV/\sqrt{Hz}$ specification for the op amp voltage noise alone. This reflects the noise added to the output by the inverting current noise times the feedback resistor. As the gain is increased, this fixed output noise power term contributes less to the total output noise and the total input referred voltage noise given by Equation 3 will approach just the $3.7nV/\sqrt{Hz}$ of the op amp itself. For example, going to a gain of +20 in the circuit of Figure 1, adjusting only the gain resistor to 52.3Ω , will give a total input referred noise of $3.9nV/\sqrt{Hz}$. A more complete description of op amp noise analysis can be found in the TI application note SBOA066, *Noise Analysis for High Speed Op Amps*, located at www.ti.com.

DC ACCURACY AND OFFSET CONTROL

A current-feedback op amp like the OPA684 provides exceptional bandwidth in high gains, giving fast pulse settling but only moderate DC accuracy. The Electrical Characteristics show an input offset voltage comparable to high slew rate voltage-feedback amplifiers. The two input bias currents, however, are somewhat higher and are unmatched. Whereas bias current cancellation techniques are very effective with most voltage-feedback op amps, they do not generally reduce the output DC offset for wideband current-feedback op amps. Since the two input bias currents are unrelated in both magnitude and polarity, matching the source impedance looking out of each input to reduce their error contribution to the output is ineffective. Evaluating the configuration of Figure 1, using worst case $+25^\circ C$ input offset voltage and the two input bias currents, gives a worst case output offset range equal to:

$$\begin{aligned} & \pm(G_N \cdot V_{OS}) + (I_{BN} \cdot R_S/2 \cdot G_N) \pm (I_{BI} \cdot R_F) \\ & = \pm(2 \cdot 3.5mV) \pm (10\mu A \cdot 25\Omega \cdot 2) \pm (1k\Omega \cdot 16\mu A) \\ & = \pm 7mV + 0.5mV \pm 16mV \\ & = \pm 23.5mV \end{aligned}$$

where $G_N =$ non-inverting signal gain

While the last term, the inverting bias current error, is dominant in this low-gain circuit, the input offset voltage will become the dominant DC error term as the gain exceeds $5V/V$. Where improved DC precision is required in a high-speed amplifier, consider the OPA642 single and OPA2822 dual voltage-feedback amplifiers.

DISABLE OPERATION

The OPA684 provides an optional disable feature that may be used to reduce system power when amplifier operation is not required. If the V_{DIS} control pin is left unconnected, the OPA684 will operate normally. To disable, the V_{DIS} control pin must be asserted LOW. Figure 14 shows a simplified internal circuit for the disable control feature.

In normal operation, base current to Q1 is provided through the $250k\Omega$ resistor, while the emitter current through the $40k\Omega$ resistor sets up a voltage drop that is inadequate to turn on the two diodes in Q1's emitter. As V_{DIS} is pulled LOW, additional current is pulled through the $40k\Omega$ resistor eventually turning on these two diodes. At this point, any further current pulled out of V_{DIS} goes through those diodes holding the emitter-base voltage of Q1 at approximately $0V$. This shuts off the collector current out of Q1, turning the amplifier off. The supply current in the disable mode is only what is required to operate the circuit of Figure 14.

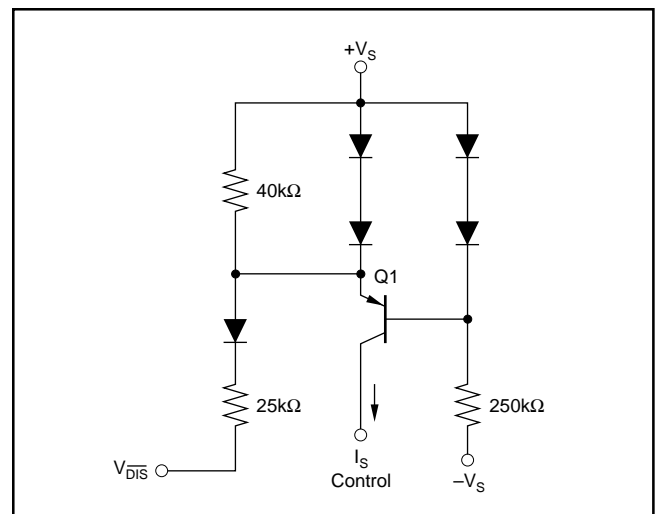

FIGURE 14. Simplified Disable Control Circuit.

When disabled, the output and input nodes go to a high impedance state. If the OPA684 is operating at a gain of +1 (with a $1k\Omega$ feedback resistor still required for stability), it will show a very high impedance ($1.7pF \parallel 1M\Omega$) at the output and exceptional signal isolation. If operating at a gain greater than +1, the total feedback network resistance ($R_F + R_G$) will appear as the impedance looking back into the output, but the circuit will still show very high forward and reverse isolation. If configured as an inverting amplifier, the input and output will be connected through the feedback network resistance ($R_F + R_G$) giving relatively poor input to output isolation.

The OPA684 provides very high power gain on low quiescent current levels. When disabled, internal high impedance nodes discharge slowly that, with the exceptional power gain provided, give a self-powering characteristic that leads to a slow turn-off characteristic. Typical turn-off times to rated 100 μ A disabled supply current are 4ms. Turn-on times are very fast—less than 40ns.

THERMAL ANALYSIS

The OPA684 will not require external heatsinking for most applications. Maximum desired junction temperature will set the maximum allowed internal power dissipation as described below. In no case should the maximum junction temperature be allowed to exceed 175°C.

Operating junction temperature (T_J) is given by $T_A + P_D \cdot \theta_{JA}$. The total internal power dissipation (P_D) is the sum of quiescent power (P_{DQ}) and additional power dissipated in the output stage (P_{DL}) to deliver load power. Quiescent power is simply the specified no-load supply current times the total supply voltage across the part. P_{DL} will depend on the required output signal and load but would, for a grounded resistive load, be at a maximum when the output is fixed at a voltage equal to 1/2 of either supply voltage (for equal bipolar supplies). Under this condition $P_{DL} = V_S^2 / (4 \cdot R_L)$, where R_L includes feedback network loading.

Note that it is the power in the output stage and not into the load that determines internal power dissipation.

As an absolute worst-case example, compute the maximum T_J using an OPA684IDBV (SOT23-6 package) in the circuit of Figure 1 operating at the maximum specified ambient temperature of +85°C and driving a grounded 100 Ω load.

$$P_D = 10V \cdot 1.85mA + 5^2 / (4 \cdot (100\Omega \parallel 2k\Omega)) = 84mW$$

$$\text{Maximum } T_J = +85^\circ\text{C} + (0.084W \cdot 150^\circ\text{C/W}) = 98^\circ\text{C}.$$

This maximum operating junction temperature is well below most system level targets. Most applications will be lower than this since an absolute worst-case output stage power was assumed in this calculation.

BOARD LAYOUT GUIDELINES

Achieving optimum performance with a high-frequency amplifier like the OPA684 requires careful attention to board layout parasitics and external component types. Recommendations that will optimize performance include:

- a) **Minimize parasitic capacitance** to any AC ground for all of the signal I/O pins. Parasitic capacitance on the output and inverting input pins can cause instability; on the non-inverting input, it can react with the source impedance to cause unintentional bandlimiting. To reduce unwanted capacitance, a window around the signal I/O pins should be opened in all of the ground and power planes around those pins. Otherwise, ground and power planes should be unbroken elsewhere on the board.
- b) **Minimize the distance** (< 0.25") from the power-supply pins to high-frequency 0.1 μ F decoupling capacitors. At the device pins, the ground and power plane layout should not be in close proximity to the signal I/O pins. Avoid narrow power and ground traces to minimize inductance between the pins and the decoupling capacitors. The power-supply connections should always be decoupled with these capacitors. An optional supply decoupling capacitor across the two power supplies (for bipolar operation) will improve 2nd-harmonic distortion performance. Larger (2.2 μ F to 6.8 μ F) decoupling capacitors, effective at lower frequencies, should also be used on the main supply pins. These may be placed somewhat farther from the device and may be shared among several devices in the same area of the PC board.
- c) **Careful selection and placement of external components will preserve the high-frequency performance of the OPA684.** Resistors should be a very low reactance type. Surface-mount resistors work best and allow a tighter overall layout. Metal film and carbon composition axially-leaded resistors can also provide good high-frequency performance. Again, keep their leads and PC board trace length as short as possible. Never use wirewound type resistors in a high-frequency application. Since the output pin and inverting input pin are the most sensitive to parasitic capacitance, always position the feedback and series output resistors, if any, as close as possible to the output pin. Other network components, such as non-inverting input termination resistors, should also be placed close to the package. Where double-side component mounting is allowed, place the feedback resistor directly under the package on the other side of the board between the output and inverting input pins. The frequency response is primarily determined by the feedback resistor value, as described previously. Increasing its value will reduce the peaking at higher gains, while decreasing it will give a more peaked frequency response at lower gains. The 1k Ω feedback resistor used in the electrical characteristics at a gain of +2 on $\pm 5V$ supplies is a good starting point for design. Note that a 1k Ω feedback resistor, rather than a direct short, is required for the unity-gain follower application. A current-feedback op amp requires a feedback resistor even in the unity gain follower configuration to control stability.
- d) **Connections to other wideband devices** on the board may be made with short direct traces or through on-board transmission lines. For short connections, consider the trace and the input to the next device as a lumped capacitive load. Relatively wide traces (50mils to 100mils) should be used, preferably with ground and power planes opened up around them. Estimate the total capacitive load and set R_S from the plot of recommended R_S vs C_{LOAD} . Low parasitic capacitive loads (< 5pF) may not need an R_S since the OPA684 is

nominally compensated to operate with a 2pF parasitic load. If a long trace is required, and the 6dB signal loss intrinsic to a doubly-terminated transmission line is acceptable, implement a matched impedance transmission line using microstrip or stripline techniques (consult an ECL design handbook for microstrip and stripline layout techniques). A 50Ω environment is normally not necessary onboard, and in fact a higher impedance environment will improve distortion, as shown in the distortion versus load plots. With a characteristic board trace impedance defined based on board material and trace dimensions, a matching series resistor into the trace from the output of the OPA684 is used, as well as a terminating shunt resistor at the input of the destination device. Remember also that the terminating impedance will be the parallel combination of the shunt resistor and the input impedance of the destination device; this total effective impedance should be set to match the trace impedance. The high output voltage and current capability of the OPA684 allows multiple destination devices to be handled as separate transmission lines, each with their own series and shunt terminations. If the 6dB attenuation of a doubly-terminated transmission line is unacceptable, a long trace can be series-terminated at the source end only. Treat the trace as a capacitive load in this case and set the series resistor value as shown in the plot of R_S vs C_{LOAD} . This will not preserve signal integrity as well as a doubly-terminated line. If the input impedance of the destination device is low, there will be some signal attenuation due to the voltage divider formed by the series output into the terminating impedance.

- e) **Socketing a high-speed part like the OPA684 is not recommended.** The additional lead length and pin-to-pin capacitance introduced by the socket can create an extremely troublesome parasitic network which can make it almost impossible to achieve a smooth, stable frequency response. Best results are obtained by soldering the OPA684 onto the board.

INPUT AND ESD PROTECTION

The OPA684 is built using a very high-speed complementary bipolar process. The internal junction breakdown voltages are relatively low for these very small geometry devices. These breakdowns are reflected in the Absolute Maximum Ratings table where an absolute maximum 13V across the supply pins is reported. All device pins have limited ESD protection using internal diodes to the power supplies, as shown in Figure 15.

These diodes provide moderate protection to input overdrive voltages above the supplies as well. The protection diodes can typically support 30mA continuous current. Where higher currents are possible (e.g. in systems with $\pm 15V$ supply parts driving into the OPA684), current limiting series resistors should be added into the two inputs. Keep these resistor values as low as possible since high values degrade both noise performance and frequency response.

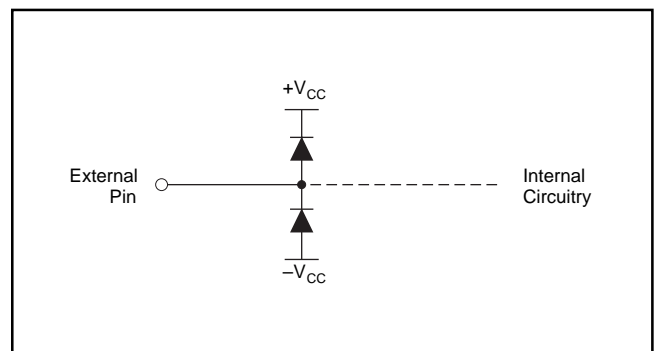

FIGURE 15. Internal ESD Protection.

Revision History

DATE	REVISION	PAGE	SECTION	DESCRIPTION
6/09	D	2	Related Products	Replaced OPA685 (obsolete) with OPA695 family.
		4	Electrical Characteristics	Added missing value (0.006) to <i>Closed-Loop Output Impedance</i> parameter.
		8	Typical Characteristics	Changed <i>Open-Loop Transimpedance Gain and Phase</i> plot to fix typo.
		9	Typical Characteristics	Changed <i>Closed-Loop Output Impedance vs Frequency</i> plot to fix typo.
7/08	C	2	Abs Max Ratings	Changed Storage Temperature Range from -40°C to $+125^{\circ}\text{C}$ to -65°C to $+125^{\circ}\text{C}$.
		3, 4	Electrical Characteristics	Added Minimum Operating Voltage Range to Power-Supply subsection.

NOTE: Page numbers for previous revisions may differ from page numbers in the current version.

PACKAGING INFORMATION

Orderable Device	Status (1)	Package Type	Package Drawing	Pins	Package Qty	Eco Plan (2)	Lead/Ball Finish (6)	MSL Peak Temp (3)	Op Temp (°C)	Device Marking (4/5)	Samples
OPA684ID	ACTIVE	SOIC	D	8	75	Green (RoHS & no Sb/Br)	NIPDAU	Level-2-260C-1 YEAR	-40 to 85	OPA 684	Samples
OPA684IDBVR	ACTIVE	SOT-23	DBV	6	3000	Green (RoHS & no Sb/Br)	NIPDAU	Level-2-260C-1 YEAR	-40 to 85	B84	Samples
OPA684IDBVRG4	ACTIVE	SOT-23	DBV	6	3000	Green (RoHS & no Sb/Br)	NIPDAU	Level-2-260C-1 YEAR	-40 to 85	B84	Samples
OPA684IDBVT	ACTIVE	SOT-23	DBV	6	250	Green (RoHS & no Sb/Br)	NIPDAU	Level-2-260C-1 YEAR	-40 to 85	B84	Samples
OPA684IDBVTG4	ACTIVE	SOT-23	DBV	6	250	Green (RoHS & no Sb/Br)	NIPDAU	Level-2-260C-1 YEAR	-40 to 85	B84	Samples
OPA684IDR	ACTIVE	SOIC	D	8	2500	Green (RoHS & no Sb/Br)	NIPDAU	Level-2-260C-1 YEAR	-40 to 85	OPA 684	Samples

(1) The marketing status values are defined as follows:

ACTIVE: Product device recommended for new designs.

LIFEBUY: TI has announced that the device will be discontinued, and a lifetime-buy period is in effect.

NRND: Not recommended for new designs. Device is in production to support existing customers, but TI does not recommend using this part in a new design.

PREVIEW: Device has been announced but is not in production. Samples may or may not be available.

OBSELETE: TI has discontinued the production of the device.

(2) **RoHS:** TI defines "RoHS" to mean semiconductor products that are compliant with the current EU RoHS requirements for all 10 RoHS substances, including the requirement that RoHS substance do not exceed 0.1% by weight in homogeneous materials. Where designed to be soldered at high temperatures, "RoHS" products are suitable for use in specified lead-free processes. TI may reference these types of products as "Pb-Free".

RoHS Exempt: TI defines "RoHS Exempt" to mean products that contain lead but are compliant with EU RoHS pursuant to a specific EU RoHS exemption.

Green: TI defines "Green" to mean the content of Chlorine (Cl) and Bromine (Br) based flame retardants meet JS709B low halogen requirements of <=1000ppm threshold. Antimony trioxide based flame retardants must also meet the <=1000ppm threshold requirement.

(3) MSL, Peak Temp. - The Moisture Sensitivity Level rating according to the JEDEC industry standard classifications, and peak solder temperature.

(4) There may be additional marking, which relates to the logo, the lot trace code information, or the environmental category on the device.

(5) Multiple Device Markings will be inside parentheses. Only one Device Marking contained in parentheses and separated by a "~" will appear on a device. If a line is indented then it is a continuation of the previous line and the two combined represent the entire Device Marking for that device.

⁽⁶⁾ Lead/Ball Finish - Orderable Devices may have multiple material finish options. Finish options are separated by a vertical ruled line. Lead/Ball Finish values may wrap to two lines if the finish value exceeds the maximum column width.

Important Information and Disclaimer:The information provided on this page represents TI's knowledge and belief as of the date that it is provided. TI bases its knowledge and belief on information provided by third parties, and makes no representation or warranty as to the accuracy of such information. Efforts are underway to better integrate information from third parties. TI has taken and continues to take reasonable steps to provide representative and accurate information but may not have conducted destructive testing or chemical analysis on incoming materials and chemicals. TI and TI suppliers consider certain information to be proprietary, and thus CAS numbers and other limited information may not be available for release.

In no event shall TI's liability arising out of such information exceed the total purchase price of the TI part(s) at issue in this document sold by TI to Customer on an annual basis.

TAPE AND REEL INFORMATION



QUADRANT ASSIGNMENTS FOR PIN 1 ORIENTATION IN TAPE



*All dimensions are nominal

Device	Package Type	Package Drawing	Pins	SPQ	Reel Diameter (mm)	Reel Width W1 (mm)	A0 (mm)	B0 (mm)	K0 (mm)	P1 (mm)	W (mm)	Pin1 Quadrant
OPA684IDR	SOIC	D	8	2500	330.0	12.4	6.4	5.2	2.1	8.0	12.0	Q1

TAPE AND REEL BOX DIMENSIONS



*All dimensions are nominal

Device	Package Type	Package Drawing	Pins	SPQ	Length (mm)	Width (mm)	Height (mm)
OPA684IDR	SOIC	D	8	2500	367.0	367.0	35.0

DBV0006A



PACKAGE OUTLINE

SOT-23 - 1.45 mm max height

SMALL OUTLINE TRANSISTOR

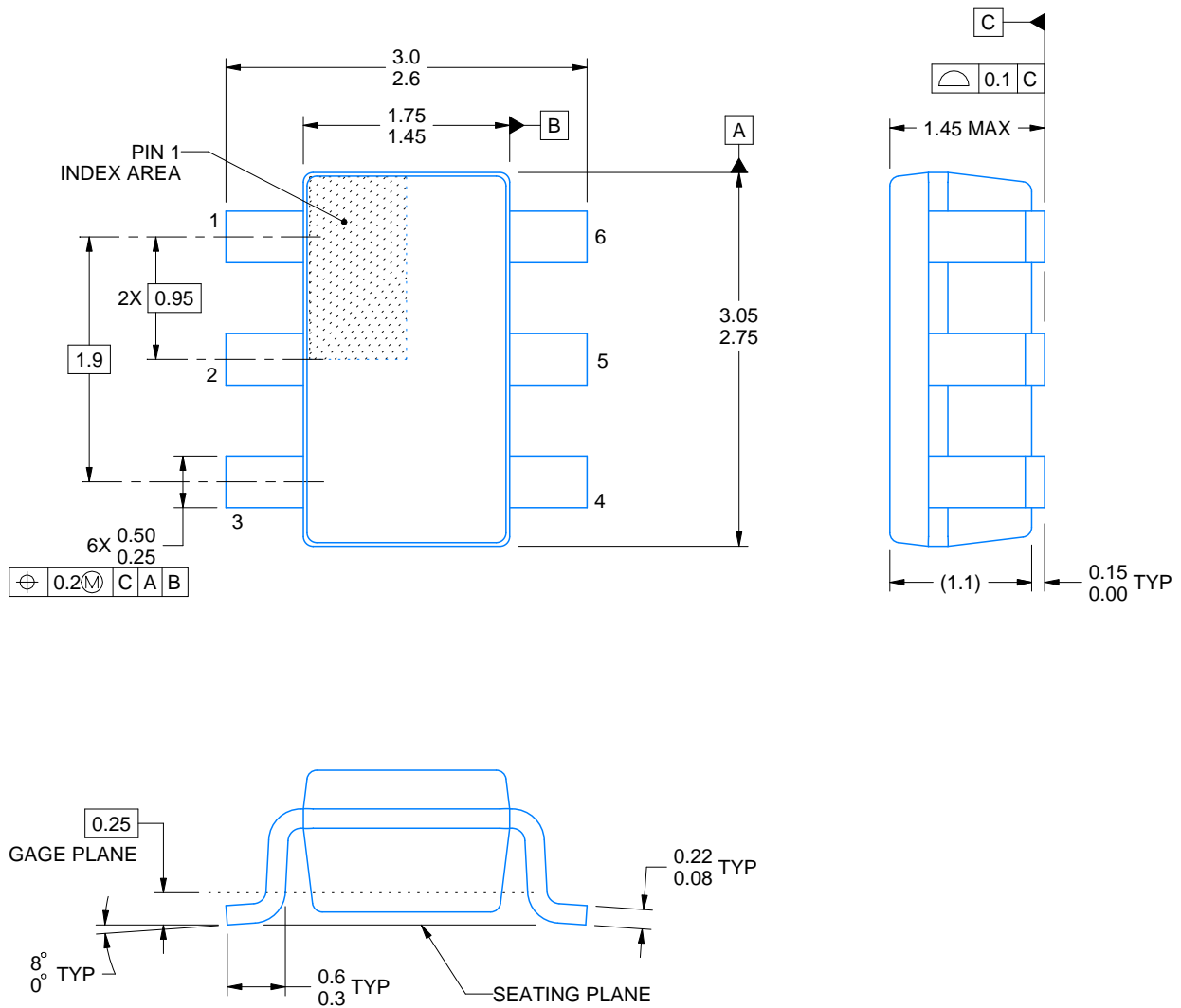

4214840/B 03/2018

NOTES:

1. All linear dimensions are in millimeters. Any dimensions in parenthesis are for reference only. Dimensioning and tolerancing per ASME Y14.5M.
2. This drawing is subject to change without notice.
3. Body dimensions do not include mold flash or protrusion. Mold flash and protrusion shall not exceed 0.15 per side.
4. Leads 1,2,3 may be wider than leads 4,5,6 for package orientation.
5. Reference JEDEC MO-178.

EXAMPLE BOARD LAYOUT

DBV0006A

SOT-23 - 1.45 mm max height

SMALL OUTLINE TRANSISTOR



LAND PATTERN EXAMPLE
EXPOSED METAL SHOWN
SCALE:15X

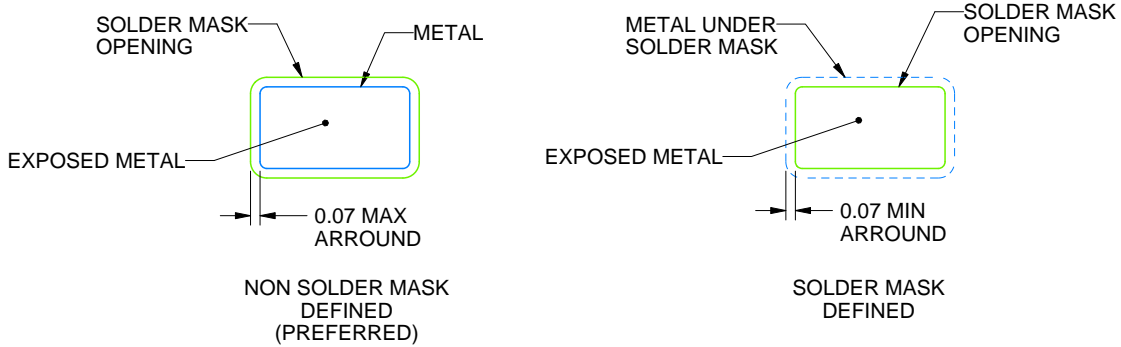

SOLDER MASK DETAILS

4214840/B 03/2018

NOTES: (continued)

- 6. Publication IPC-7351 may have alternate designs.
- 7. Solder mask tolerances between and around signal pads can vary based on board fabrication site.

EXAMPLE STENCIL DESIGN

DBV0006A

SOT-23 - 1.45 mm max height

SMALL OUTLINE TRANSISTOR



SOLDER PASTE EXAMPLE
BASED ON 0.125 mm THICK STENCIL
SCALE:15X

4214840/B 03/2018

NOTES: (continued)

8. Laser cutting apertures with trapezoidal walls and rounded corners may offer better paste release. IPC-7525 may have alternate design recommendations.
9. Board assembly site may have different recommendations for stencil design.



D0008A

PACKAGE OUTLINE

SOIC - 1.75 mm max height

SMALL OUTLINE INTEGRATED CIRCUIT



4214825/C 02/2019

NOTES:

- Linear dimensions are in inches [millimeters]. Dimensions in parenthesis are for reference only. Controlling dimensions are in inches. Dimensioning and tolerancing per ASME Y14.5M.
- This drawing is subject to change without notice.
- This dimension does not include mold flash, protrusions, or gate burrs. Mold flash, protrusions, or gate burrs shall not exceed $.006$ [0.15] per side.
- This dimension does not include interlead flash.
- Reference JEDEC registration MS-012, variation AA.

EXAMPLE BOARD LAYOUT

D0008A

SOIC - 1.75 mm max height

SMALL OUTLINE INTEGRATED CIRCUIT



LAND PATTERN EXAMPLE
 EXPOSED METAL SHOWN
 SCALE:8X



SOLDER MASK DETAILS

4214825/C 02/2019

NOTES: (continued)

- 6. Publication IPC-7351 may have alternate designs.
- 7. Solder mask tolerances between and around signal pads can vary based on board fabrication site.

EXAMPLE STENCIL DESIGN

D0008A

SOIC - 1.75 mm max height

SMALL OUTLINE INTEGRATED CIRCUIT

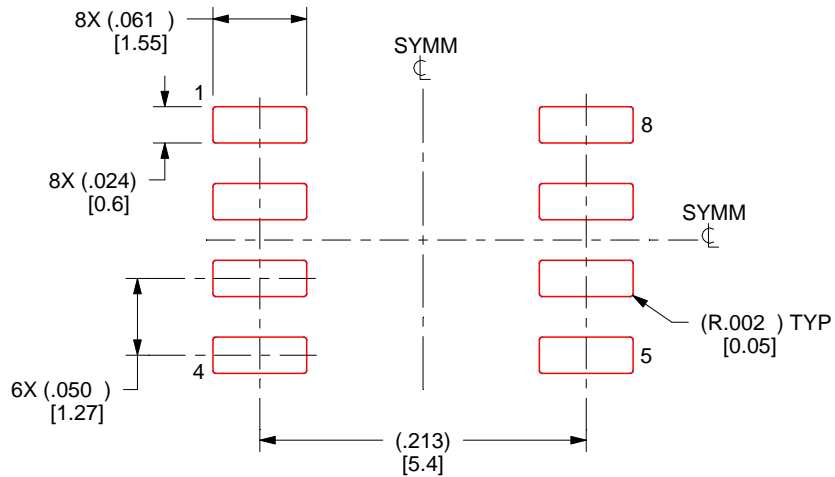

SOLDER PASTE EXAMPLE
BASED ON .005 INCH [0.125 MM] THICK STENCIL
SCALE:8X

4214825/C 02/2019

NOTES: (continued)

8. Laser cutting apertures with trapezoidal walls and rounded corners may offer better paste release. IPC-7525 may have alternate design recommendations.
9. Board assembly site may have different recommendations for stencil design.

IMPORTANT NOTICE AND DISCLAIMER

TI PROVIDES TECHNICAL AND RELIABILITY DATA (INCLUDING DATASHEETS), DESIGN RESOURCES (INCLUDING REFERENCE DESIGNS), APPLICATION OR OTHER DESIGN ADVICE, WEB TOOLS, SAFETY INFORMATION, AND OTHER RESOURCES "AS IS" AND WITH ALL FAULTS, AND DISCLAIMS ALL WARRANTIES, EXPRESS AND IMPLIED, INCLUDING WITHOUT LIMITATION ANY IMPLIED WARRANTIES OF MERCHANTABILITY, FITNESS FOR A PARTICULAR PURPOSE OR NON-INFRINGEMENT OF THIRD PARTY INTELLECTUAL PROPERTY RIGHTS.

These resources are intended for skilled developers designing with TI products. You are solely responsible for (1) selecting the appropriate TI products for your application, (2) designing, validating and testing your application, and (3) ensuring your application meets applicable standards, and any other safety, security, or other requirements. These resources are subject to change without notice. TI grants you permission to use these resources only for development of an application that uses the TI products described in the resource. Other reproduction and display of these resources is prohibited. No license is granted to any other TI intellectual property right or to any third party intellectual property right. TI disclaims responsibility for, and you will fully indemnify TI and its representatives against, any claims, damages, costs, losses, and liabilities arising out of your use of these resources.

TI's products are provided subject to TI's Terms of Sale (www.ti.com/legal/termsofsale.html) or other applicable terms available either on ti.com or provided in conjunction with such TI products. TI's provision of these resources does not expand or otherwise alter TI's applicable warranties or warranty disclaimers for TI products.

Mailing Address: Texas Instruments, Post Office Box 655303, Dallas, Texas 75265
Copyright © 2020, Texas Instruments Incorporated