



**MICROCHIP**

---

**Digital Power  
Development Board  
User's Guide**

---

---

**Note the following details of the code protection feature on Microchip devices:**

- Microchip products meet the specification contained in their particular Microchip Data Sheet.
- Microchip believes that its family of products is one of the most secure families of its kind on the market today, when used in the intended manner and under normal conditions.
- There are dishonest and possibly illegal methods used to breach the code protection feature. All of these methods, to our knowledge, require using the Microchip products in a manner outside the operating specifications contained in Microchip's Data Sheets. Most likely, the person doing so is engaged in theft of intellectual property.
- Microchip is willing to work with the customer who is concerned about the integrity of their code.
- Neither Microchip nor any other semiconductor manufacturer can guarantee the security of their code. Code protection does not mean that we are guaranteeing the product as "unbreakable."

Code protection is constantly evolving. We at Microchip are committed to continuously improving the code protection features of our products. Attempts to break Microchip's code protection feature may be a violation of the Digital Millennium Copyright Act. If such acts allow unauthorized access to your software or other copyrighted work, you may have a right to sue for relief under that Act.

---

Information contained in this publication regarding device applications and the like is provided only for your convenience and may be superseded by updates. It is your responsibility to ensure that your application meets with your specifications. MICROCHIP MAKES NO REPRESENTATIONS OR WARRANTIES OF ANY KIND WHETHER EXPRESS OR IMPLIED, WRITTEN OR ORAL, STATUTORY OR OTHERWISE, RELATED TO THE INFORMATION, INCLUDING BUT NOT LIMITED TO ITS CONDITION, QUALITY, PERFORMANCE, MERCHANTABILITY OR FITNESS FOR PURPOSE. Microchip disclaims all liability arising from this information and its use. Use of Microchip devices in life support and/or safety applications is entirely at the buyer's risk, and the buyer agrees to defend, indemnify and hold harmless Microchip from any and all damages, claims, suits, or expenses resulting from such use. No licenses are conveyed, implicitly or otherwise, under any Microchip intellectual property rights unless otherwise stated.

*Microchip received ISO/TS-16949:2009 certification for its worldwide headquarters, design and wafer fabrication facilities in Chandler and Tempe, Arizona; Gresham, Oregon and design centers in California and India. The Company's quality system processes and procedures are for its PIC® MCUs and dsPIC® DSCs, KEELOQ® code hopping devices, Serial EEPROMs, microperipherals, nonvolatile memory and analog products. In addition, Microchip's quality system for the design and manufacture of development systems is ISO 9001:2000 certified.*

**QUALITY MANAGEMENT SYSTEM  
CERTIFIED BY DNV  
= ISO/TS 16949 =**

### Trademarks

The Microchip name and logo, the Microchip logo, AnyRate, AVR, AVR logo, AVR Freaks, BitCloud, chipKIT, chipKIT logo, CryptoMemory, CryptoRF, dsPIC, FlashFlex, flexPWR, Helder, JukeBlox, KeeLoq, Klear, LANCheck, LINK MD, maXStylus, maXTouch, MediaLB, megaAVR, MOST, MOST logo, MPLAB, OptoLyzer, PIC, picoPower, PICSTART, PIC32 logo, Prochip Designer, QTouch, SAM-BA, SpyNIC, SST, SST Logo, SuperFlash, tinyAVR, UNI/O, and XMEGA are registered trademarks of Microchip Technology Incorporated in the U.S.A. and other countries.

ClockWorks, The Embedded Control Solutions Company, EtherSynch, Hyper Speed Control, HyperLight Load, IntelliMOS, mTouch, Precision Edge, and Quiet-Wire are registered trademarks of Microchip Technology Incorporated in the U.S.A.

Adjacent Key Suppression, AKS, Analog-for-the-Digital Age, Any Capacitor, AnyIn, AnyOut, BodyCom, CodeGuard, CryptoAuthentication, CryptoAutomotive, CryptoCompanion, CryptoController, dsPICDEM, dsPICDEM.net, Dynamic Average Matching, DAM, ECAN, EtherGREEN, In-Circuit Serial Programming, ICSP, INICnet, Inter-Chip Connectivity, JitterBlocker, KlearNet, KlearNet logo, memBrain, Mindi, MiWi, motorBench, MPASM, MPF, MPLAB Certified logo, MPLIB, MPLINK, MultiTRAK, NetDetach, Omniscient Code Generation, PICDEM, PICDEM.net, PICKit, PICtail, PowerSmart, PureSilicon, QMatrix, REAL ICE, Ripple Blocker, SAM-ICE, Serial Quad I/O, SMART-I.S., SQI, SuperSwitcher, SuperSwitcher II, Total Endurance, TSHARC, USBCheck, VariSense, ViewSpan, WiperLock, Wireless DNA, and ZENA are trademarks of Microchip Technology Incorporated in the U.S.A. and other countries.

SQTP is a service mark of Microchip Technology Incorporated in the U.S.A.

Silicon Storage Technology is a registered trademark of Microchip Technology Inc. in other countries.

GestIC is a registered trademark of Microchip Technology Germany II GmbH & Co. KG, a subsidiary of Microchip Technology Inc., in other countries.

All other trademarks mentioned herein are property of their respective companies.

© 2018, Microchip Technology Incorporated, All Rights Reserved.

ISBN: 978-1-5224-3762-8

**Table of Contents**

<b>Preface .....</b>	<b>5</b>
<b>Chapter 1. Overview.....</b>	<b>9</b>
1.1 Introduction .....	9
1.2 Features .....	9
1.2.1 Socket for DP PIM Boards .....	10
1.2.2 Test Points .....	10
1.2.3 Grounding System .....	11
1.2.4 External Analog Signal Input .....	11
1.2.5 DC Level Insertion .....	11
1.2.6 Analog Input Connection Jumpers .....	11
1.2.7 Push Buttons .....	11
1.2.8 MikroBUS™ Socket .....	11
1.2.9 ICSP™ Programming Port .....	12
1.2.10 General Purpose Soldering Pad Area .....	12
1.2.11 Solder Pad for Ground Connection .....	12
1.2.12 USB Connector .....	12
1.2.13 On-Board LDO .....	12
1.2.14 Power Indicator LED .....	12
1.2.15 User LEDs .....	12
1.3 Electrical Characteristics .....	12
<b>Appendix A. Board Layout and Schematics.....</b>	<b>13</b>
A.1 Pinout .....	13
A.2 Board Schematic .....	14
A.3 PCB Layout .....	15
<b>Appendix B. Bill of Materials (BOM).....</b>	<b>19</b>
B.1 Bill of Materials .....	19
<b>Worldwide Sales and Service .....</b>	<b>22</b>

# Digital Power Development Board User's Guide

---

NOTES:

---

---

## Preface

---

---

### NOTICE TO CUSTOMERS

All documentation becomes dated, and this manual is no exception. Microchip tools and documentation are constantly evolving to meet customer needs, so some actual dialogs and/or tool descriptions may differ from those in this document. Please refer to our website ([www.microchip.com](http://www.microchip.com)) to obtain the latest documentation available.

Documents are identified with a “DS” number. This number is located on the bottom of each page, in front of the page number. The numbering convention for the DS number is “DSXXXXXXXXA”, where “XXXXXXXX” is the document number and “A” is the revision level of the document.

For the most up-to-date information on development tools, see the MPLAB® IDE online help. Select the Help menu, and then Topics to open a list of available online help files.

## INTRODUCTION

This chapter contains general information that will be useful to know before using the Digital Power Development Board. Items discussed in this chapter include:

- [Document Layout](#)
- [Conventions Used in this Guide](#)
- [Recommended Reading](#)
- [The Microchip Website](#)
- [Product Change Notification Service](#)
- [Customer Support](#)
- [Document Revision History](#)

## DOCUMENT LAYOUT

This document describes how to use the Digital Power Development Board User's Guide as a demonstration tool to provide a measurement platform for the Microchip dsPIC33 devices' Digital Power Plug-In Modules. The document is organized as follows:

- [Chapter 1. “Overview”](#) — This chapter introduces the Digital Power Development Board and provides a brief overview of its various features.
- [Appendix A. “Board Layout and Schematics”](#) — This appendix presents the schematics and the board layouts for the Digital Power Development Board.
- [Appendix B. “Bill of Materials \(BOM\)”](#) — This appendix presents the Bill of Materials for the Digital Power Development Board.

# Digital Power Development Board User's Guide

---

## CONVENTIONS USED IN THIS GUIDE

This manual uses the following documentation conventions:

### DOCUMENTATION CONVENTIONS

Description	Represents	Examples
<b>Arial font:</b>		
Italic characters	Referenced books	<i>MPLAB<sup>®</sup> IDE User's Guide</i>
	Emphasized text	...is the <i>only</i> compiler...
Initial caps	A window	the Output window
	A dialog	the Settings dialog
	A menu selection	select Enable Programmer
Quotes	A field name in a window or dialog	"Save project before build"
Underlined, italic text with right angle bracket	A menu path	<u><i>File&gt;Save</i></u>
Bold characters	A dialog button	Click <b>OK</b>
	A tab	Click the <b>Power</b> tab
N'Rnnnn	A number in verilog format, where N is the total number of digits, R is the radix and n is a digit.	4'b0010, 2'hF1
Text in angle brackets < >	A key on the keyboard	Press <Enter>, <F1>
<b>Courier New font:</b>		
Plain Courier New	Sample source code	#define START
	Filenames	autoexec.bat
	File paths	c:\mcc18\h
	Keywords	_asm, _endasm, static
	Command-line options	-Opa+, -Opa-
	Bit values	0, 1
	Constants	0xFF, 'A'
Italic Courier New	A variable argument	<i>file.o</i> , where <i>file</i> can be any valid filename
Square brackets [ ]	Optional arguments	mcc18 [options] <i>file</i> [options]
Curly brackets and pipe character: {   }	Choice of mutually exclusive arguments; an OR selection	errorlevel {0 1}
Ellipses...	Replaces repeated text	var_name [, var_name...]
	Represents code supplied by user	void main (void) { ... }

## RECOMMENDED READING

This user's guide describes how to use the Digital Power Development Board. Other useful document(s) are listed below. The following Microchip document(s) are recommended as supplemental reference resources.

- **dsPIC33 Family Digital Power PIM User's Guides** are available for download from the Microchip website ([www.microchip.com](http://www.microchip.com))

## THE MICROCHIP WEBSITE

Microchip provides online support via our website at [www.microchip.com](http://www.microchip.com). This website is used as a means to make files and information easily available to customers. Accessible by using your favorite Internet browser, the website contains the following information:

- **Product Support** – Data sheets and errata, application notes and sample programs, design resources, user's guides and hardware support documents, latest software releases and archived software
- **General Technical Support** – Frequently Asked Questions (FAQs), technical support requests, online discussion groups, Microchip consultant program member listing
- **Business of Microchip** – Product selector and ordering guides, latest Microchip press releases, listing of seminars and events; and listings of Microchip sales offices, distributors and factory representatives

## PRODUCT CHANGE NOTIFICATION SERVICE

Microchip's customer notification service helps keep customers current on Microchip products. Subscribers will receive e-mail notification whenever there are changes, updates, revisions or errata related to a specified product family or development tool of interest.

To register, access the Microchip website at [www.microchip.com](http://www.microchip.com), click on **Product Change Notification** and follow the registration instructions.

## CUSTOMER SUPPORT

Users of Microchip products can receive assistance through several channels:

- Distributor or Representative
- Local Sales Office
- Corporate Application Engineer (CAE)
- Embedded Solutions Engineer (ESE)

Customers should contact their distributor, representative or Embedded Solutions Engineer (ESE) for support. Local sales offices are also available to help customers. A listing of sales offices and locations is included in the back of this document.

Technical support is available through the website at:

<http://www.microchip.com/support>.

## DOCUMENT REVISION HISTORY

### Revision A (October 2018)

This is the initial version of this document.

# Digital Power Development Board User's Guide

---

NOTES:

## Chapter 1. Overview

### 1.1 INTRODUCTION

The Digital Power Development Board is a demonstration board that provides the user with a flexible measurement platform for all compatible Microchip dsPIC33 Digital Power Plug-In Modules (DP PIMs). DP PIMs can be inserted into the mating socket J1 in the middle of the Digital Power Development Board. All pins of the DP PIM are accessible via test loops or pin headers. The on-board micro USB connector provides a DC power input to all circuitry. In addition, a mikroBUS™ socket is provided to extend functionality.

This chapter provides an overview of the features of the Digital Power Development Board. The topics covered include:

- [Features](#)
- [Electrical Characteristics](#)

### 1.2 FEATURES

The Digital Power Development Board has the following features, as shown in [Figure 1-1](#).

**FIGURE 1-1: DIGITAL POWER DEVELOPMENT BOARD**

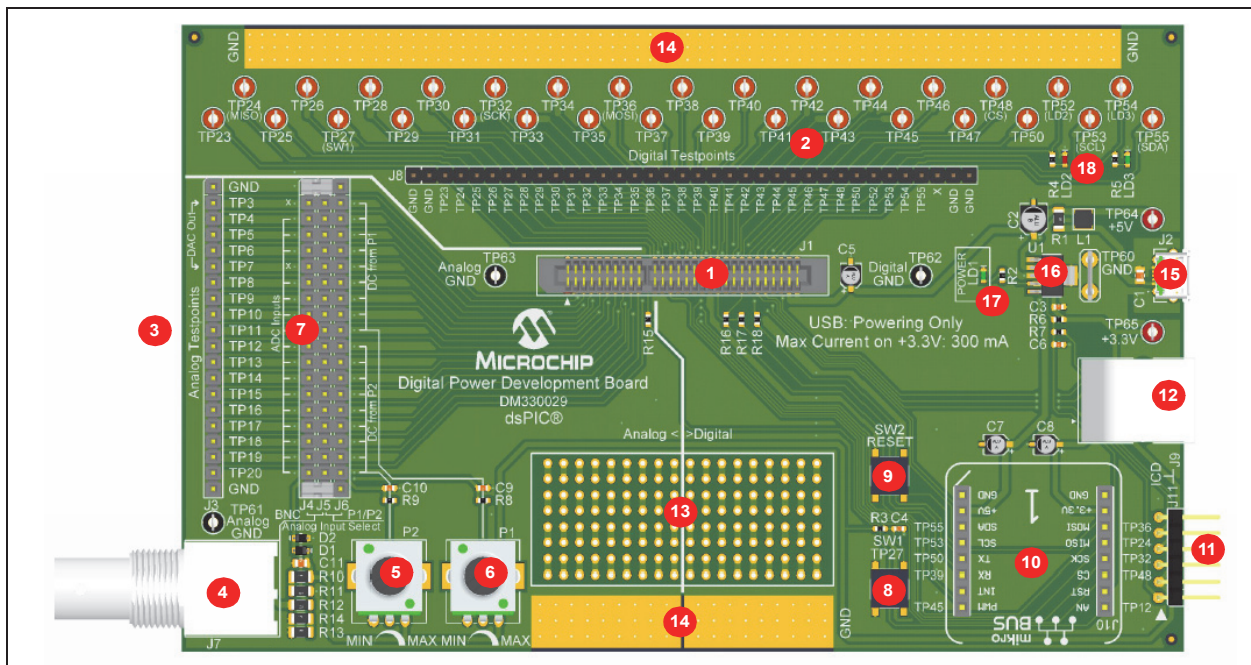

1. Socket for DP PIM boards.
2. Digital GPIO test points. Pin header with connection to the digital test points.
3. ADC and DAC test points.
4. External analog signal input.
5. Potentiometer for DC level insertion from GND to +3.3V; it can be connected to the lower half of the ADC inputs.

# Digital Power Development Board User's Guide

---

6. Potentiometer for DC level insertion from GND to +3.3V; it can be connected to the upper half of the ADC inputs.
7. Analog input connection jumpers.
8. User push button.
9. Reset push button.
10. mikroBUS socket.
11. ICSP™ header to program the on-board MCU (6-pin, 2.54 mm header).
12. ICSP header to program the on-board MCU (RJ25 connector).
13. General purpose soldering pad area.
14. Solder pads for ground connection.
15. USB connector.
16. On-board LDO with Power Good (PG) function.
17. Power indicator LED (Green).
18. User LEDs (Red and Green).

Board dimensions are: 160 mm (length) x 100 mm (height).

## 1.2.1 Socket for DP PIM Boards

Insert the DP PIM board under test into the socket located in the middle of the Digital Power Development Board. Socket J1 has a slot that defines the DP PIM board direction. Be careful not to break the slot when inserting the DP PIM board into the socket.

## 1.2.2 Test Points

The Digital Power Development Board ensures good signal integrity and provides access to all pins of a DP PIM board. Each signal line is named after the DP PIM edge connector pin number, with a “TP” (Test Point) prefix on the schematic diagram, which is similarly marked on the silkscreen. These signals are divided into two main sections: Analog and Digital (see [Figure 1-1](#)). For a detailed pinout, refer to the User's Guide of the DP PIM under test.

### 1. Analog Section

The analog section is located at the left connector side (smaller sector of the socket). It consists of 18 signal lines, all referenced to analog ground. These lines are split into two subsections:

- ADC inputs
- DAC output

### 2. Digital Section

The digital section is located at the right connector side (larger sector of the socket). It consists of 31 lines, all referenced to digital ground. These lines support all the digital lines of the DP PIMs. Some of them have dedicated functions, such as:

- High-speed PWM outputs
- Medium speed GPIO
- Communication lines (SPI, I<sup>2</sup>C, UART)
- User push button and LEDs

## 1.2.3 Grounding System

The entire board ground potential is connected together and forms one galvanically common domain. The labels, “Analog” and “Digital”, indicate the geometrical domain. The copper pour connected to the ground potential is split into two geometrical domains, but the two geometrical domains are jointed together under the PIM socket, thus improving the signal integrity and keeping noise confined to near their sources.

## 1.2.4 External Analog Signal Input

It is possible to insert an analog signal to any ADC input from a signal generator via a standard BNC connector. The input impedance is 50Ω. Input signals between the ground and +3.3V are accepted. An overvoltage protection is implemented on this input with a series resistor, and a pair of parallel diodes between the ground and the positive supply rail.

## 1.2.5 DC Level Insertion

Two on-board potentiometers are connected between the ground and the +3.3V supply rail to provide two stable DC levels. The two DC levels can be set independently with potentiometers: P1 and P2. These DC signals can be used as an input signal to any ADC input. The DC level set by P1 can be connected to the upper half, while P2 can be connected to the lower half of the ADC inputs, at the analog input connection jumpers.

## 1.2.6 Analog Input Connection Jumpers

The ADC inputs of the DP PIM board can be accessed directly from the pin header (J3) located at the left side of the board. These inputs can also be connected to either the external analog signal input (J7) or to the DC level insertion, respectively. The three-row pin header matrix, J4, J5, J6 (No. 7 in [Figure 1-1](#)), forms a three-pin selection jumper for each ADC input. When placing a jumper over the left, or over the right and the middle pins, the corresponding ADC input can be connected to the extra input as indicated on the silkscreen. The left side pins connect the external analog signal input, while the right side pins connect the DC level insertion to the given ADC input. Two positions on the DAC outputs are not connected. The pins on those positions are just placeholders to keep the pin order. Three pins are connected to GND at both ends of the jumper row. Jumpers can be stored on those pins if not needed. Two jumpers are provided in the kit.

## 1.2.7 Push Buttons

There are two push buttons on the board: SW1 and SW2. Push button SW2, which is directly connected to the RESET pin of the DP PIM board, is for the system Reset. For dual core devices, this RESET is connected to the Master core Reset line. Push button SW1 is a general purpose user interface connected to the TP27 test point and the corresponding pin on the DP PIM.

## 1.2.8 MikroBUS™ Socket

A standard extension socket (J10) is provided on the board for mikroBUS click boards™. The functionality of the board can be easily extended by using this feature. The DP PIM board communicates with the mikroBUS socket via dedicated SPI lines and the I<sup>2</sup>C bus. Both +5V and +3.3V supply rails are connected to the corresponding pins of the mikroBUS socket. The Reset button is connected to the mikroBUS socket RESET pin.

# Digital Power Development Board User's Guide

---

## 1.2.9 ICSP™ Programming Port

Dedicated lines for programming the MCU device on the inserted DP PIM board are accessible via an RJ-25 modular connector or on a 6-pin header.

## 1.2.10 General Purpose Soldering Pad Area

The soldering point matrix on the bottom of the board with Plated-Through-Hole (PTH) pads can be used to assemble any small extension circuitry needed for testing or prototyping.

## 1.2.11 Solder Pad for Ground Connection

A bare gold-plated copper area is located on the upper and the bottom edges of the board. These areas can either be used for soldering a solid ground connection or for attaching alligator clips to connect instrument ground.

## 1.2.12 USB Connector

The Digital Power Development Board can be powered via the micro USB connector, J2, at the right side of the board. The DP PIM board supply input and the +5V power rail for the mikroBUS click board are directly connected to the positive supply line of the USB. This connector is only for powering. The input voltage must be in the range of 3.6V to 6.3V. The mikroBUS click board can tighten this constraint; please refer to the specifications before powering. Communication is not possible via this USB connector.

## 1.2.13 On-Board LDO

The +3.3V power rail for the mikroBUS click board is supplied by the on-board LDO (Microchip's MCP1755), connected to the +5V supply rail coming from the USB. The total load for the mikroBUS click board supply current and the additional load caused by its active GPIO lines should not exceed 300 mA. The DC level insertion potentiometer and the pull-up resistor of the user push button are also connected to this line. The Power Good output drives the Reset line of the board, ensuring stable performance.

## 1.2.14 Power Indicator LED

The green LED (LD1) is on when the supply voltage is applied on the +5V supply rail.

## 1.2.15 User LEDs

The Digital Power Development Board has two user-programmable on-board LEDs. The red LED is connected to TP52, while the green LED is connected to TP54. Logic level high drives the LEDs.

## 1.3 ELECTRICAL CHARACTERISTICS

Table 1-1 shows the electrical characteristics of the Digital Power Development Board.

**TABLE 1-1: ELECTRICAL CHARACTERISTICS**

Parameter	Value
Input Voltage Range	3.6 VDC to 6.3 VDC
Current Consumption	<10 mA
Maximal Load Current	1A
Operating Temperature Range	0°C to +65°C

## Appendix A. Board Layout and Schematics

This appendix contains the pinout, schematics and board layouts for the Digital Power Development Board. The topics covered in this appendix include:

- [Pinout](#)
- [Board Schematic](#)
- [PCB Layout](#)

### A.1 PINOUT

Table A-1 shows the pinout of the Digital Power Development Board.

**TABLE A-1: PINOUT**

Name	Edge Connector Pin	Default Function/Description
GND	1, 2	Analog Ground
DAC OUT	3, 7	DAC Output
ADC IN	4..6, 8..20	Analog Input
Slot	21..22	Aligning Slot
GPIO	23	Digital General Purpose
GPIO	24	Digital General Purpose and SPI_MISO
GPIO	25..31	Digital General Purpose
GPIO	32	Digital General Purpose and SPI_SCK
GPIO	33..35	Digital General Purpose
GPIO	36	Digital General Purpose and SPI_MOSI
GPIO	37..38	Digital General Purpose
GPIO	39	Digital General Purpose and SER0 (UART to mikroBUS™ socket)
GPIO	40..44	Digital General Purpose
PWM1H	45	PWM Output
GPIO	46	Digital General Purpose
PWM1L	47	PWM Output
GPIO	48	Digital General Purpose and SPI Chip Select
MCLR	49	Reset
GPIO	50	Digital General Purpose and SER1 (UART to mikroBUS socket)
PGEC	51	Programming/Debugging Line
GPIO	52	Digital General Purpose and Red LED
SCL	53	I <sup>2</sup> C Clock Line
GPIO	54	Digital General Purpose and Green LED
SDA	55	I <sup>2</sup> C Data Line
PGED	56	Programming/Debugging Line
5V	57, 59	VDD Rail
GND	58, 60	Digital Ground



# Board Layout and Schematics

## A.3 PCB LAYOUT

The Digital Power Development Board is a two-layer FR4, 1.55 mm, Plated-Through-Hole PCB construction. Figure A-2 through Figure A-5 illustrate the PCB layers. Figure A-6 and Figure A-7 show the assembly drawings of the Digital Power Development Board.

FIGURE A-2: DIGITAL POWER DEVELOPMENT BOARD TOP SILKSCREEN

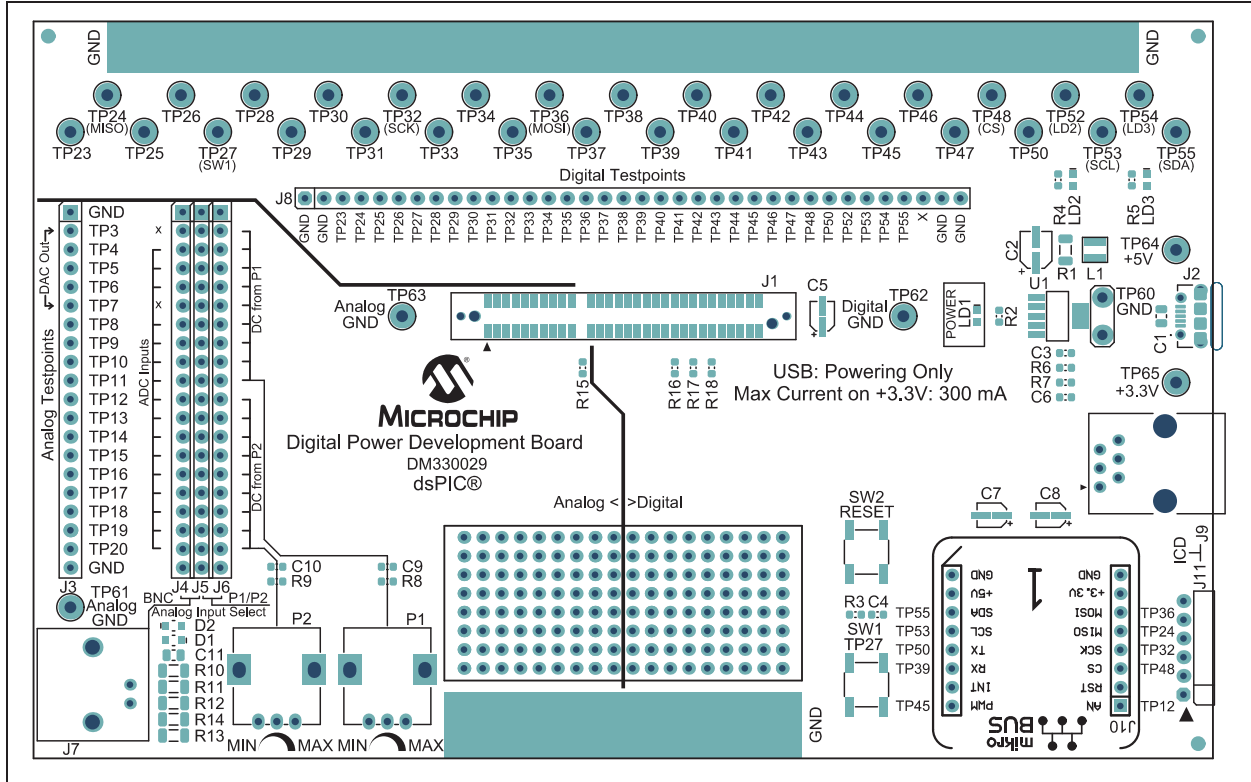
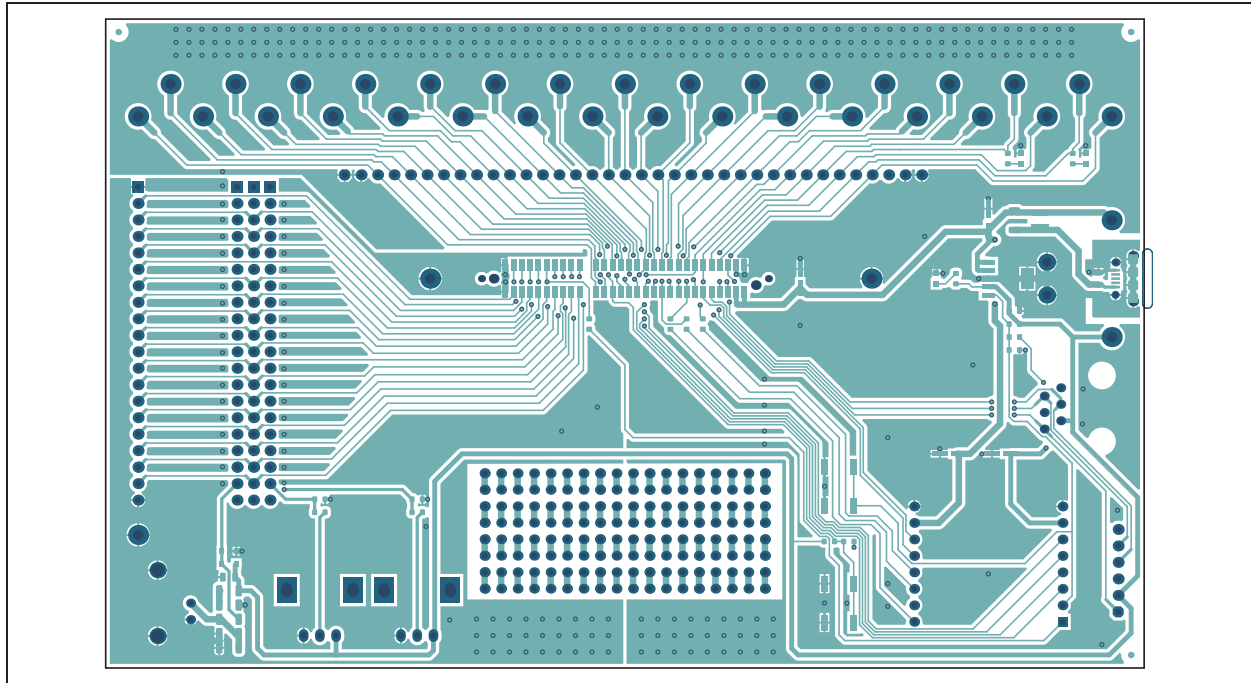

FIGURE A-3: DIGITAL POWER DEVELOPMENT BOARD TOP COPPER



# Digital Power Development Board User's Guide

FIGURE A-4: DIGITAL POWER DEVELOPMENT BOARD BOTTOM COPPER (BOTTOM VIEW)

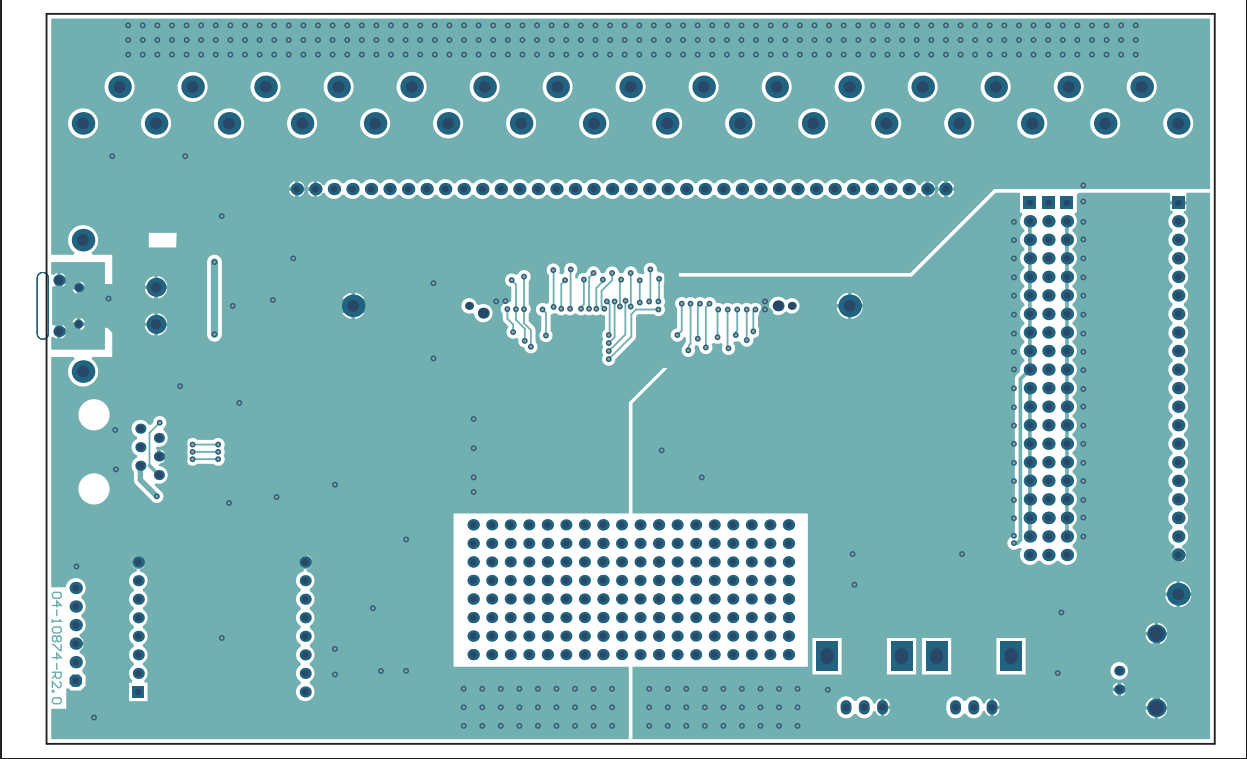
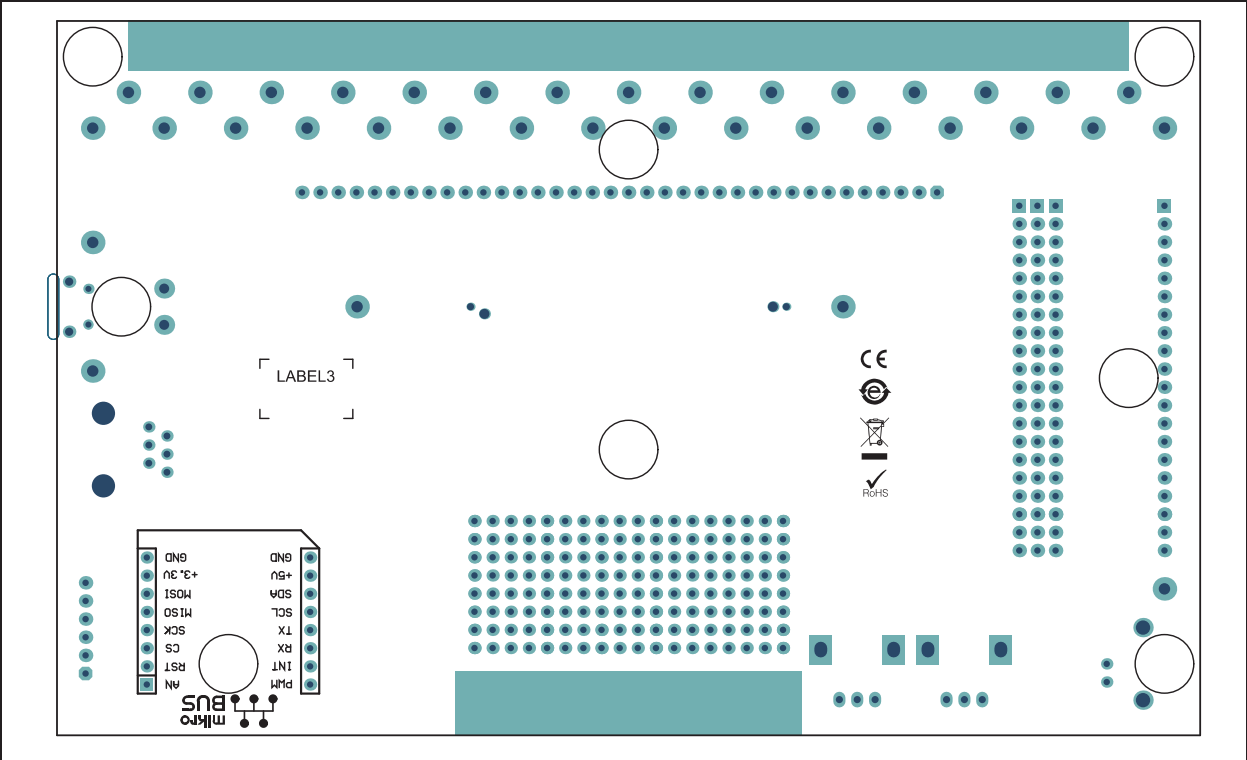

FIGURE A-5: DIGITAL POWER DEVELOPMENT BOARD BOTTOM SILKSCREEN (BOTTOM VIEW)



# Board Layout and Schematics

FIGURE A-6: DIGITAL POWER DEVELOPMENT BOARD TOP ASSEMBLY

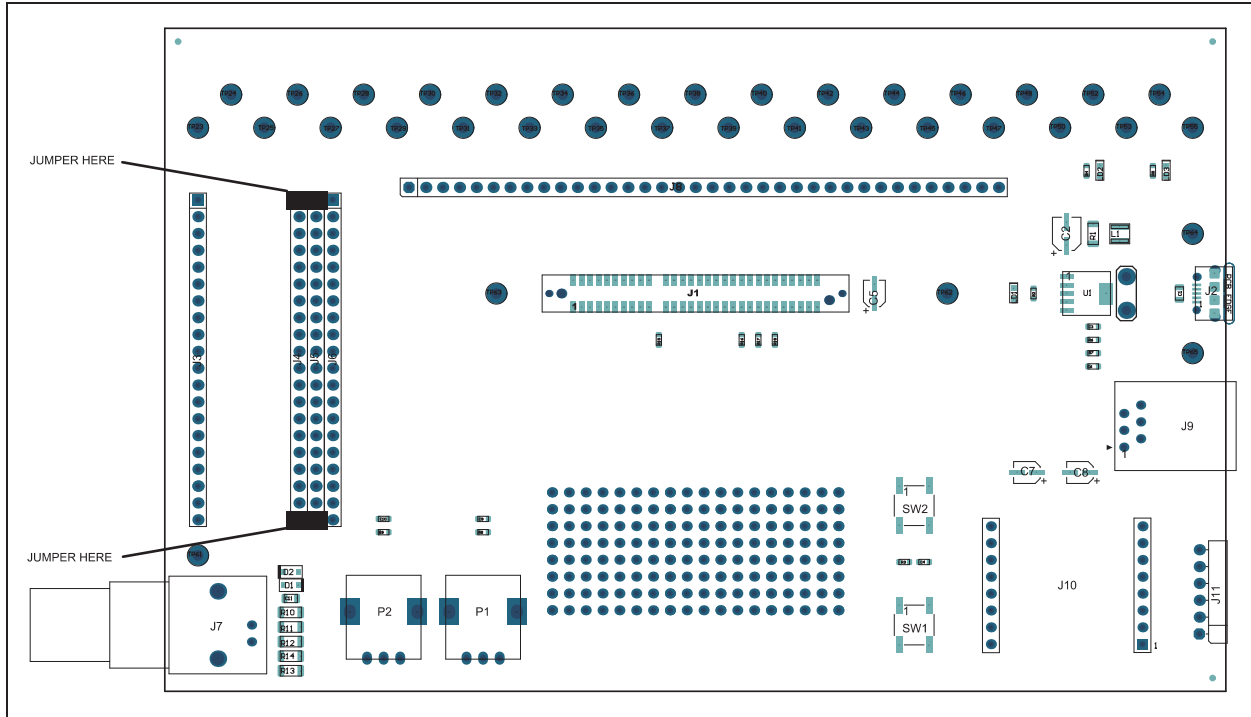
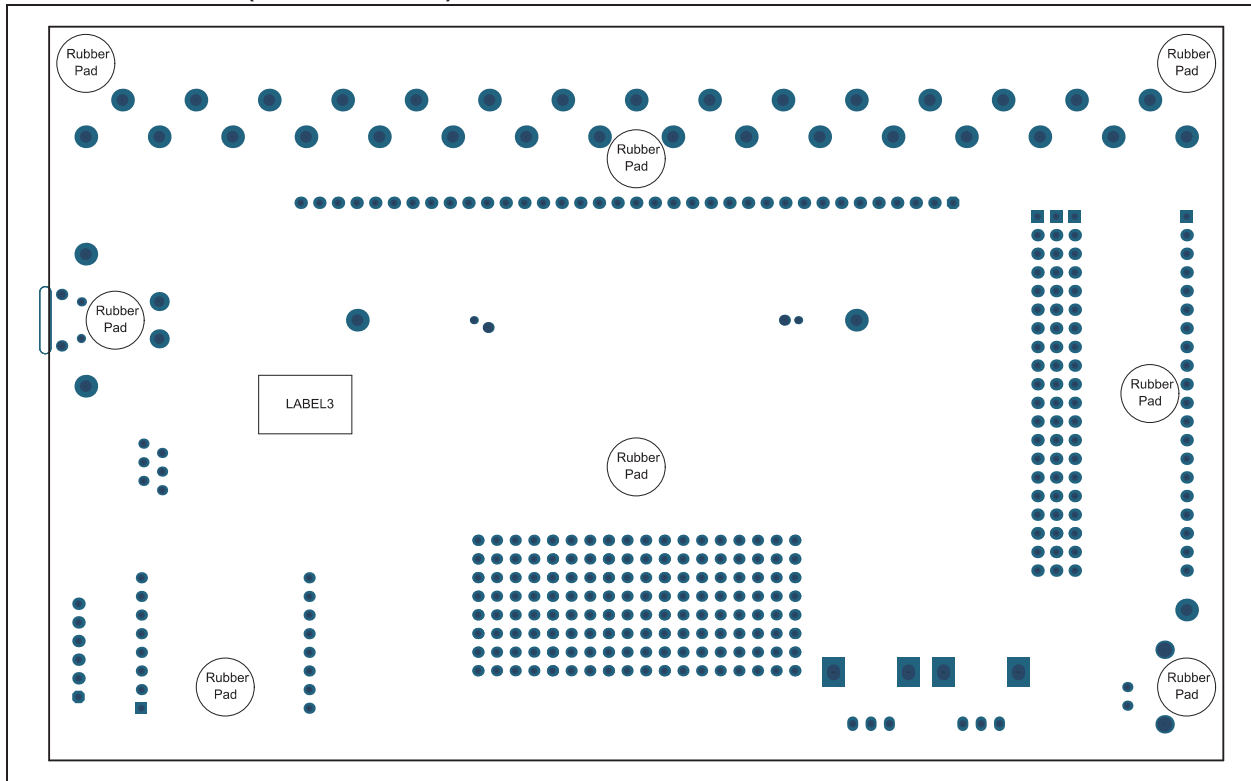

FIGURE A-7: DIGITAL POWER DEVELOPMENT BOARD BOTTOM ASSEMBLY (BOTTOM VIEW)



# Digital Power Development Board User's Guide

---

NOTES:

## Appendix B. Bill of Materials (BOM)

This appendix contains the Bill of Materials (BOM) for the Digital Power Development Board.

- [Bill of Materials](#)

### B.1 BILL OF MATERIALS

Table B-1 shows the Bill of Materials for the Digital Power Development Board.

**TABLE B-1: DIGITAL POWER DEV. BOARD BILL OF MATERIALS (BOM)**

Qty.	Designator	Description	Manufacturer	Manufacturer Part Number
2	C1, C11	Capacitor, Ceramic, 10 $\mu$ F, 16V, 20%, X7R, SMD, 0805	Taiyo Yuden Co., Ltd.	EMK212BB7106MG-T
1	C2	Capacitor Aluminum, 33 $\mu$ F, 10V, 20%, SMD, B	Panasonic® - ECG	EEE-1AA330WR
3	C3, C9, C10	Capacitor Ceramic, 1 $\mu$ F, 50V, 10%, X7R, SMD, 0603	Taiyo Yuden Co., Ltd.	UMK107AB7105KA-T
2	C4, C6	Capacitor Ceramic, 0.01 $\mu$ F, 100V, 10%, X7R, SMD, 0603	TDK Corporation	C1608X7R2A103K080AA
3	C5, C7, C8	Capacitor, Aluminum, 10 $\mu$ F, 16V, 20%, SMD, A	Nichicon Corporation	UWX1C100MCL2GB
2	D1, D2	Diode, Rectifier, 1N4148, 855 mV, 300 mA, 75V, SOD-323	Diodes Incorporated®	1N4148WS-7-F
1	J1	Connector, Edge, MECF, 1.27 mm, 60P, Female, SMD, Vertical	Samtec, Inc.	MECF-30-01-L-DV-WT
1	J2	Connector, USB 2.0, micro-B, Female, TH/SMD, R/A	FCI	10118194-0001LF
4	J3, J4, J5, J6	Connector Header-2.54, Male, 1x20, Gold, 5.84 MH, TH, Vertical	Samtec, Inc.	TSW-120-07-G-S
1	J7	Connector, RF, Coaxial, BNC, Female, 2P, TH, RA	Amphenol Commercial	31-5431-2010
1	J8	Connector Header-2.54, Male, 1x36, Gold, 5.84 MH, TH	Sullins Connector Solutions	PBC36SAAN
1	J9	Connector, Modular, RJ25, TH, R/A	Tyco Electronics (TE Connectivity Ltd.)	5555165-1
2	J10	Socket, mikroBUS™, Host, DIP, 16, TH	Sullins Connector Solutions	PPTC081LFBN-RC
1	J11	Connector Header-2.54, Male, 1x6, Gold, 5.84 MH, TH, R/A	FCI	68016-106HLF
1	L1	Inductor, 1 $\mu$ H, 2.1A, 30%, SMD, L3W3H1.5	Taiyo Yuden Co., Ltd.	NR3015T1R0N
1	LD1	Diode, LED, Green, 2V, 30 mA, 35 mcd, Clear, SMD, 0603	Lite-On®, Inc.	LTST-C190KGKT

# Digital Power Development Board User's Guide

**TABLE B-1: DIGITAL POWER DEV. BOARD BILL OF MATERIALS (BOM) (CONTINUED)**

Qty.	Designator	Description	Manufacturer	Manufacturer Part Number
1	LD2	Diode, LED, Red, 1.8V, 40 mA, 10 mcd, Clear, SMD, 0603	Lite-On <sup>®</sup> , Inc.	LTST-C190KRKT
1	LD3	Diode, LED, Green, 2.2V, 25 mA, 18 mcd, Diffuse, SMD, 0603	Lumex <sup>®</sup> Inc.	SML-LX0603GW-TR
2	P1, P2	Resistor, Variable, 10K, 20%, TH, P090S	TT Electronics Plc.	P090S-14T20BR10K
1	R1	Resistor, TKF, 1R, 1%, 1/2W, SMD, 1206	Stackpole Electronics, Inc.	CSR1206FT1R00
1	R2	Resistor, TKF, 1.5k, 1%, 1/10W, SMD, 0603	Panasonic <sup>®</sup> - ECG	ERJ-3EKF1501V
3	R3, R4, R5	Resistor, TKF, 3.3k, 1%, 1/10W, SMD, 0603	Panasonic - ECG	ERJ-3EKF3301V
1	R6	Resistor, TKF, 22k, 1%, 1/10W, SMD, 0603	Panasonic - ECG	ERJ-3EKF2202V
1	R7	Resistor, TKF, 150R, 1%, 1/10W, SMD, 0603	Stackpole Electronics, Inc.	RMCF0603FT150R
2	R8, R9	Resistor, TKF, 1k, 1%, 1/10W, SMD, 0603	Panasonic - ECG	ERJ-3EKF1001V
5	R10, R11, R12, R13, R14	Resistor, TKF, 100R, 1%, 1/4W, SMD, 1206	Yageo Corporation	RC1206FR-07100RL
4	R15, R16, R17, R18	Resistor, TKF, 0R, 1/10W, SMD, 0603	NIC Components Corp.	NRC06Z0TRF
2	SW1, SW2	Switch, Tact, SPST, 12V, 50 mA, MCLTL-613R	Multicomp Inc.	MCLTL-613R
31	TP23, TP24, TP25, TP26, TP27, TP28, TP29, TP30, TP31, TP32, TP33, TP34, TP35, TP36, TP37, TP38, TP39, TP40, TP41, TP42, TP43, TP44, TP45, TP46, TP47, TP48, TP50, TP52, TP53, TP54, TP55	Connector, TP, Loop, Orange, TH	Keystone Electronics Corp.	5013
1	TP60	Connector, TP, Tab, 0.250, TH	Tyco Electronics (TE Connectivity Ltd.)	1217861-1
3	TP61, TP62, TP63	Connector, TP, Loop, Black, TH	Keystone Electronics Corp.	5011
2	TP64, TP65	Connector, TP, Loop, Red, TH	Keystone Electronics Corp.	5010
1	U1	Microchip Analog, LDO, 3.3V, MCP1755T-3302E/DC, SOT-223-5	Microchip Technology Inc.	<b>MCP1755T-3302E/DC</b>

# Bill of Materials (BOM)

---

---

NOTES:



# MICROCHIP

## Worldwide Sales and Service

### AMERICAS

**Corporate Office**  
2355 West Chandler Blvd.  
Chandler, AZ 85224-6199  
Tel: 480-792-7200  
Fax: 480-792-7277  
Technical Support:  
<http://www.microchip.com/support>  
Web Address:  
[www.microchip.com](http://www.microchip.com)

#### Atlanta

Duluth, GA  
Tel: 678-957-9614  
Fax: 678-957-1455

#### Austin, TX

Tel: 512-257-3370

#### Boston

Westborough, MA  
Tel: 774-760-0087  
Fax: 774-760-0088

#### Chicago

Itasca, IL  
Tel: 630-285-0071  
Fax: 630-285-0075

#### Dallas

Addison, TX  
Tel: 972-818-7423  
Fax: 972-818-2924

#### Detroit

Novi, MI  
Tel: 248-848-4000

#### Houston, TX

Tel: 281-894-5983

#### Indianapolis

Noblesville, IN  
Tel: 317-773-8323  
Fax: 317-773-5453  
Tel: 317-536-2380

#### Los Angeles

Mission Viejo, CA  
Tel: 949-462-9523  
Fax: 949-462-9608  
Tel: 951-273-7800

#### Raleigh, NC

Tel: 919-844-7510

#### New York, NY

Tel: 631-435-6000

#### San Jose, CA

Tel: 408-735-9110  
Tel: 408-436-4270

#### Canada - Toronto

Tel: 905-695-1980  
Fax: 905-695-2078

### ASIA/PACIFIC

**Australia - Sydney**  
Tel: 61-2-9868-6733

**China - Beijing**  
Tel: 86-10-8569-7000

**China - Chengdu**  
Tel: 86-28-8665-5511

**China - Chongqing**  
Tel: 86-23-8980-9588

**China - Dongguan**  
Tel: 86-769-8702-9880

**China - Guangzhou**  
Tel: 86-20-8755-8029

**China - Hangzhou**  
Tel: 86-571-8792-8115

**China - Hong Kong SAR**  
Tel: 852-2943-5100

**China - Nanjing**  
Tel: 86-25-8473-2460

**China - Qingdao**  
Tel: 86-532-8502-7355

**China - Shanghai**  
Tel: 86-21-3326-8000

**China - Shenyang**  
Tel: 86-24-2334-2829

**China - Shenzhen**  
Tel: 86-755-8864-2200

**China - Suzhou**  
Tel: 86-186-6233-1526

**China - Wuhan**  
Tel: 86-27-5980-5300

**China - Xian**  
Tel: 86-29-8833-7252

**China - Xiamen**  
Tel: 86-592-2388138

**China - Zhuhai**  
Tel: 86-756-3210040

### ASIA/PACIFIC

**India - Bangalore**  
Tel: 91-80-3090-4444

**India - New Delhi**  
Tel: 91-11-4160-8631

**India - Pune**  
Tel: 91-20-4121-0141

**Japan - Osaka**  
Tel: 81-6-6152-7160

**Japan - Tokyo**  
Tel: 81-3-6880-3770

**Korea - Daegu**  
Tel: 82-53-744-4301

**Korea - Seoul**  
Tel: 82-2-554-7200

**Malaysia - Kuala Lumpur**  
Tel: 60-3-7651-7906

**Malaysia - Penang**  
Tel: 60-4-227-8870

**Philippines - Manila**  
Tel: 63-2-634-9065

**Singapore**  
Tel: 65-6334-8870

**Taiwan - Hsin Chu**  
Tel: 886-3-577-8366

**Taiwan - Kaohsiung**  
Tel: 886-7-213-7830

**Taiwan - Taipei**  
Tel: 886-2-2508-8600

**Thailand - Bangkok**  
Tel: 66-2-694-1351

**Vietnam - Ho Chi Minh**  
Tel: 84-28-5448-2100

### EUROPE

**Austria - Wels**  
Tel: 43-7242-2244-39  
Fax: 43-7242-2244-393

**Denmark - Copenhagen**  
Tel: 45-4450-2828  
Fax: 45-4485-2829

**Finland - Espoo**  
Tel: 358-9-4520-820

**France - Paris**  
Tel: 33-1-69-53-63-20  
Fax: 33-1-69-30-90-79

**Germany - Garching**  
Tel: 49-8931-9700

**Germany - Haan**  
Tel: 49-2129-3766400

**Germany - Heilbronn**  
Tel: 49-7131-67-3636

**Germany - Karlsruhe**  
Tel: 49-721-625370

**Germany - Munich**  
Tel: 49-89-627-144-0  
Fax: 49-89-627-144-44

**Germany - Rosenheim**  
Tel: 49-8031-354-560

**Israel - Ra'anana**  
Tel: 972-9-744-7705

**Italy - Milan**  
Tel: 39-0331-742611  
Fax: 39-0331-466781

**Italy - Padova**  
Tel: 39-049-7625286

**Netherlands - Drunen**  
Tel: 31-416-690399  
Fax: 31-416-690340

**Norway - Trondheim**  
Tel: 47-7288-4388

**Poland - Warsaw**  
Tel: 48-22-3325737

**Romania - Bucharest**  
Tel: 40-21-407-87-50

**Spain - Madrid**  
Tel: 34-91-708-08-90  
Fax: 34-91-708-08-91

**Sweden - Gothenberg**  
Tel: 46-31-704-60-40

**Sweden - Stockholm**  
Tel: 46-8-5090-4654

**UK - Wokingham**  
Tel: 44-118-921-5800  
Fax: 44-118-921-5820